

SST-10-IR

Surface Mount Series

Infrared LED

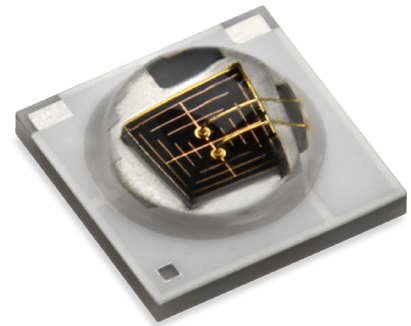

Table of Contents

| | |
|---|----|
| Technology Overview | 2 |
| Product Binning | 3 |
| Ordering Information | 3 |
| Optical and Electrical Characteristics | 4 |
| B130 - Mech. Dimensions | 6 |
| B130 - Tape and Reel | 7 |
| B90 - Mech. Dimensions | 8 |
| B90 - Tape and Reel | 9 |
| Soldering | 10 |
| Precautions | 11 |
| Revision History | 12 |

Features

- High Power Infrared LED
- Low Thermal Resistance
- Suitable for all SMT Assembly Methods
- ESD Protection
- RoHS and REACH compliant

Applications

- Surveillance Systems / CCTV
- License Plate Scanning
- Automotive Sensing
- Machine Vision
- Night Vision

Technology Overview

Luminus SST-10-IR LEDs benefit from innovations in device technology, chip packaging and thermal management. This suite of technologies give engineers and system designers the freedom to develop solutions both high in power and efficiency.

Reliability

Luminus SST-10-IR LEDs have passed a rigorous suite of environmental and mechanical stress tests, including mechanical shock, vibration, temperature cycling and humidity. They are fully qualified for use in a wide range of high performance and high efficacy applications.

REACH & RoHS Compliance

The Luminus SST-10-IR LED is compliant to the Restriction of Hazardous Substances Directive or RoHS. The restricted materials including lead, mercury cadmium hexavalent chromium, polybrominated biphenyls (PBB) and polybrominated diphenyl ether (PBDE) are not used.

Understanding Luminus SST-10-IR LED Test Specifications

Every Luminus LED is fully tested to ensure it meets the high quality standards customers have come to expect from Luminus products.

Testing Temperature

Luminus SST-10-IR LEDs are tested and binned at 25°C junction temperature. Temperature curves are provided to allow users to scale the data for actual operating temperature conditions.

Product Ordering and Shipping Part Number Nomenclature

All SST-10-IR products are packaged and labeled with part numbers as outlined in below. When shipped, each reel will contain only a single flux wavelength and Vf bin. The part number designation is as follows:

| Products | Ordering Part Number | Description |
|-----------|------------------------|-----------------------------------|
| SST-10-IR | SST-10-IR-B###-F###-00 | SST-10 surface mount infrared LED |

SST — 10 — CC — B### — F###-00

| Product Family | Chip Area | Color | Package Configuration | Bin Kit ^{1,2} |
|--|-----------------------|---------------|---|---|
| SST - Ceramic Surface Mount package w/ encapsulation | 10: 1 mm ² | IR = Infrared | B130 - 130deg Beam Angle B90 - 90 deg Beam Angle Ceramic 3.45mm x 3.45mm See Pages 6-7 for Detailed Drawings | See below for flux and wavelength binning information |

| Peak Wavelength | Minimum Flux Bin (mw) | Lens Angle | Ordering Part Number |
|-----------------|-----------------------|------------|-------------------------------|
| 850 | 265 | 130 | <i>SST-10-IR-B130-K850-00</i> |
| 850 | 265 | 90 | <i>SST-10-IR-B90-K850-00</i> |
| 940 | 205 | 130 | <i>SST-10-IR-B130-H940-00</i> |
| 940 | 205 | 90 | <i>SST-10-IR-B90-H940-00</i> |

Flux Bins¹

| Bin Code | Minimum Flux (mw) | Maximum Flux (mw) |
|----------|-------------------|-------------------|
| H | 205 | 235 |
| J | 235 | 265 |
| K | 265 | 295 |
| L | 295 | 325 |

Wavelength Bins¹

| Bin Code | Minimum Peak Wavelength (nm) | Maximum Peak Wavelength (nm) |
|----------|------------------------------|------------------------------|
| 850 | 840 | 870 |
| 940 | 925 | 955 |

Optical and Electrical Characteristics

Optical and Electrical Characteristics¹

| Parameter | Symbol | Package Type | | | | Unit |
|---------------------------------|------------------------|--------------|---------|----------|---------|------|
| | | B130-850 | B90-850 | B130-940 | B90-940 | |
| Forward Current | I_f | 350 | 350 | 350 | 350 | mA |
| Output Power Typical | PO | 280 | 280 | 225 | 225 | mw |
| Min Voltage ¹ | V_{fmin} | 1.2 | 1.2 | 1.2 | 1.2 | V |
| Forward Voltage Typical | V_f | 1.5 | 1.5 | 1.4 | 1.4 | V |
| Max Voltage ¹ | V_{fmax} | 2.0 | 2.0 | 2.0 | 2.0 | V |
| Viewing Angle | $2\ \varnothing_{1/2}$ | 130 | 90 | 130 | 90 | deg |
| Peak Wavelength Typical | λ_p | 850 | 850 | 940 | 940 | nm |
| FWHM Typical | $\Delta\lambda_{1/2}$ | 30 | 30 | 30 | 30 | nm |
| Thermal Resistance (Electrical) | R_{TH} | 5.3 | 5.3 | 5.3 | 5.3 | °C/W |

Absolute Maximum Ratings²

| Parameter | Symbol | Rating | Unit |
|-------------------------------------|------------------|--------------------|------|
| Forward Current ^{3,4} | I | 1.5 | A |
| Power Dissipation | P _D | 3.0 | W |
| Reverse Voltage | V _R | 5 | V |
| Storage Temperature | T _{STG} | -40~100 | °C |
| Junction Temperature ^{3,4} | T _J | 115 °C | °C |
| Soldering Temperature | T _{SLD} | JEDEC 020 , 260 °C | |
| ESD Sensitivity (HBM) | V _B | 6000 | V |
| | | | |

Note 1: Binning based on operation at a current of 350mA and a constant junction temperature of $T_j = 25^\circ\text{C}$. Parts are binned and shipped in 0.2V V_f increments.

Note 2: To prevent damage refer to operating conditions and derating curves for appropriate maximum operating conditions

Note 3: Luminus SST-10-IR LEDs are designed for operation up to an absolute maximum forward drive current as specified above. Product lifetime data is specified at typical forward drive currents. Sustained operation at absolute maximum currents will result in a reduction of device lifetime compared to typical forward drive currents. Actual device lifetimes will also depend on junction temperature.

Note 4: Maximum operating case temperature combined with maximum drive current defines the total maximum operating condition for the device. To prevent damage, please operate devices within specified conditions.

Note 5: Caution must be taken not to stare at the light emitted from these LEDs. Under special circumstances, the high intensity could damage the eye.

Optical and Electrical Characteristics

Relative Output Flux vs. Forward Current

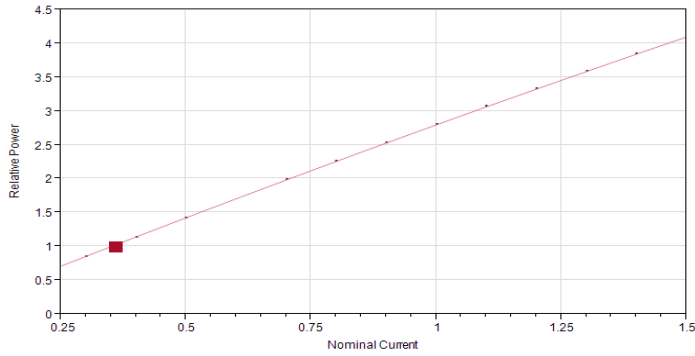

Relative Voltage vs Forward Current

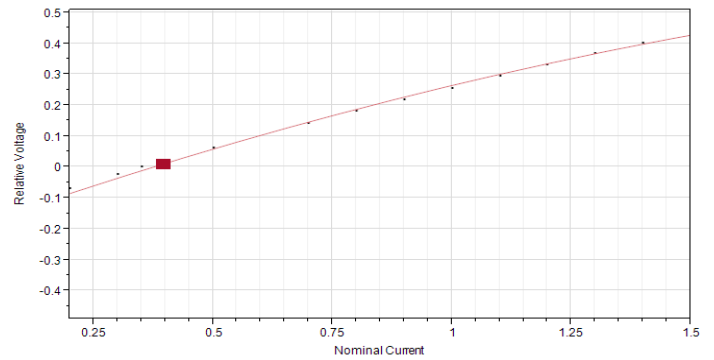

Relative Output Flux vs. Temperature

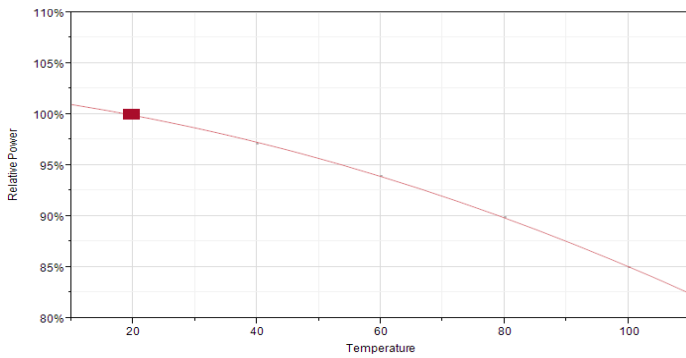

Typical Spectra

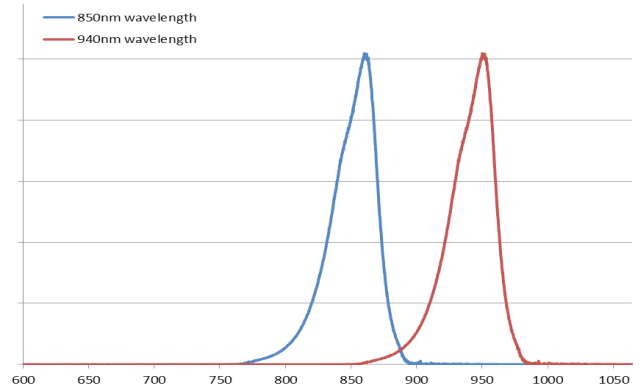

Typical Polar Radiation Plot - B130

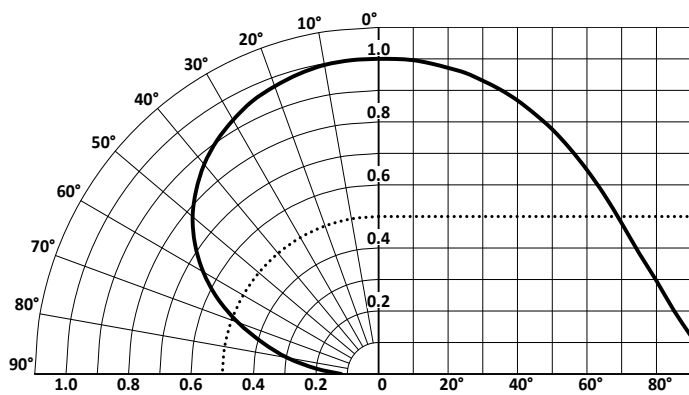

Typical Polar Radiation Plot - B90

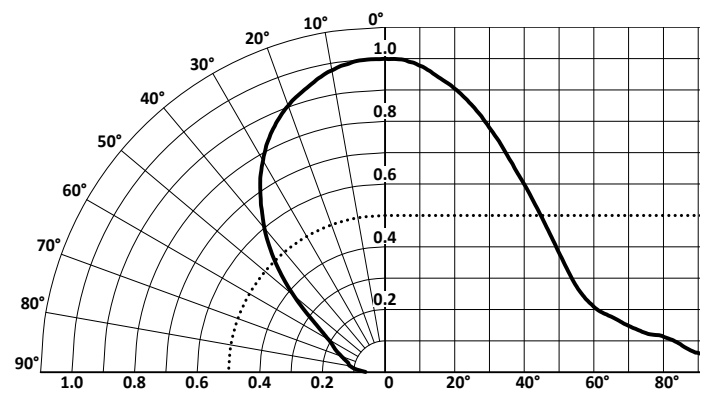

Mechanical Dimensions - B130 Package

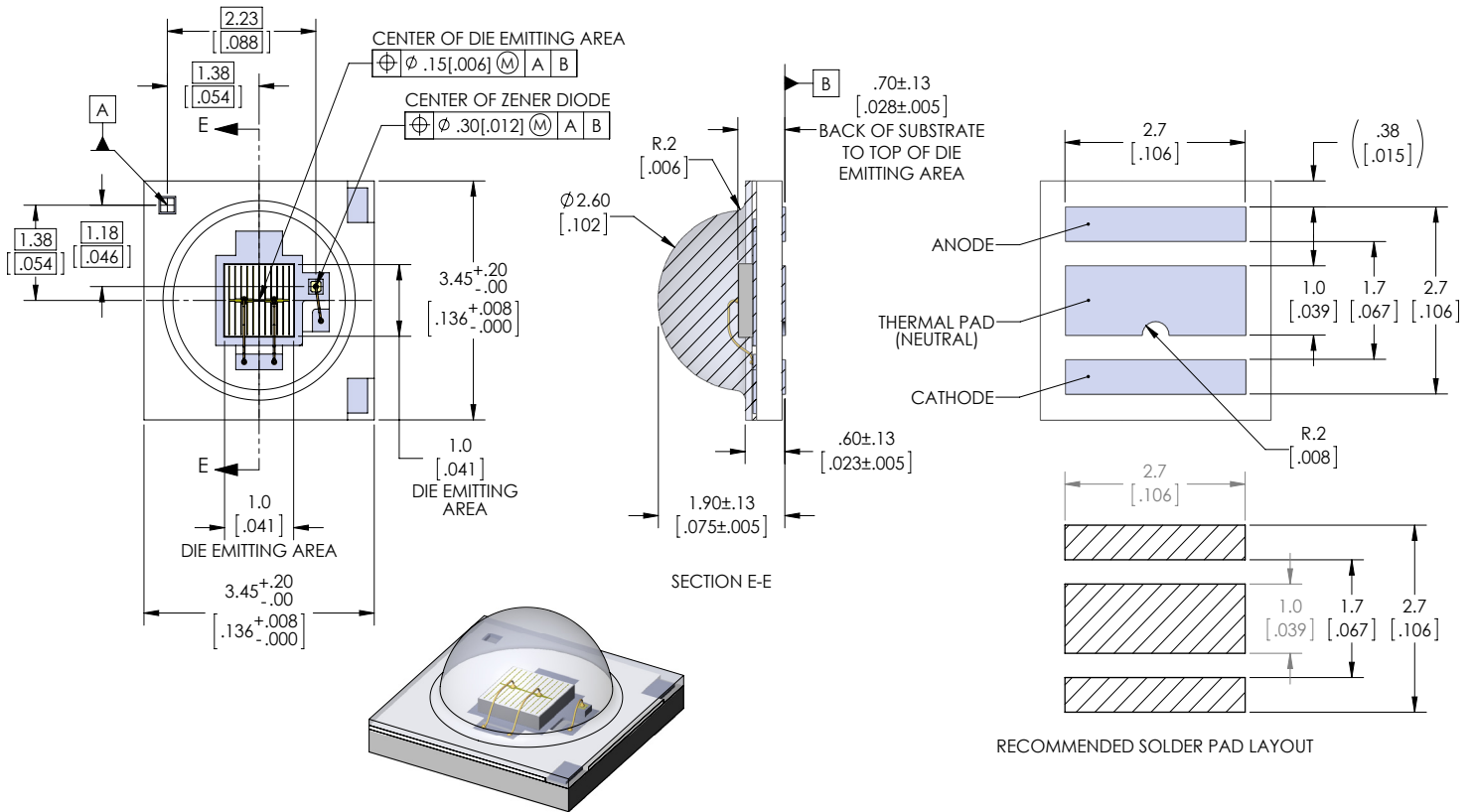

Tape and Reel - B130 Package

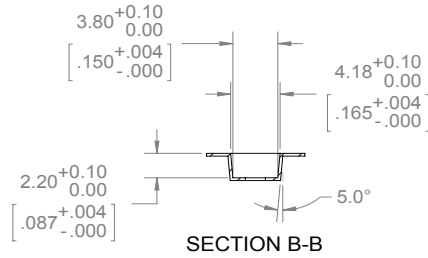
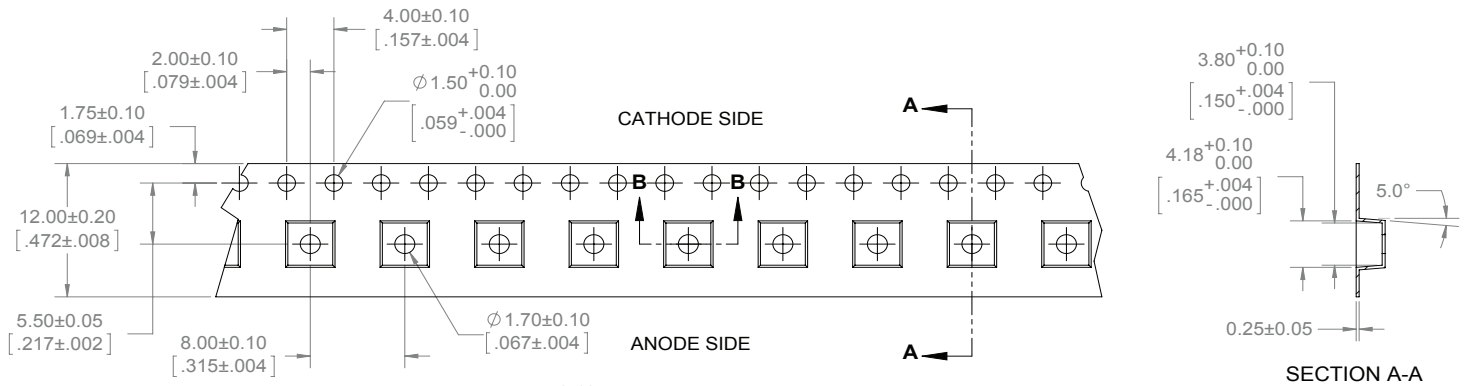

NOTES:

1. FINAL TAPE AND REEL PACKAGING MUST MEET THE REQUIREMENTS OF JEDEC-STD-033, LEVEL 2A.
2. LEAVE 304.8mm [12.00 in] OF TAPE EMPTY FOR LEAD IN (38 EMPTY POCKETS).
3. LEAVE 457.2mm [18.00 in] OF TAPE EMPTY FOR TRAILER (57 EMPTY POCKETS).
4. MUST COMPLY TO EIA-481-C-2003

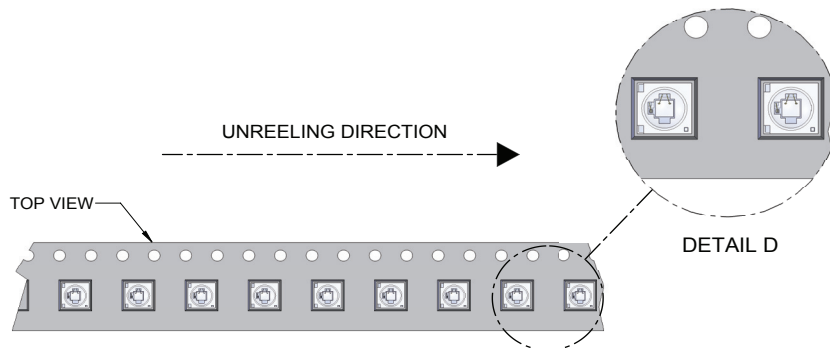
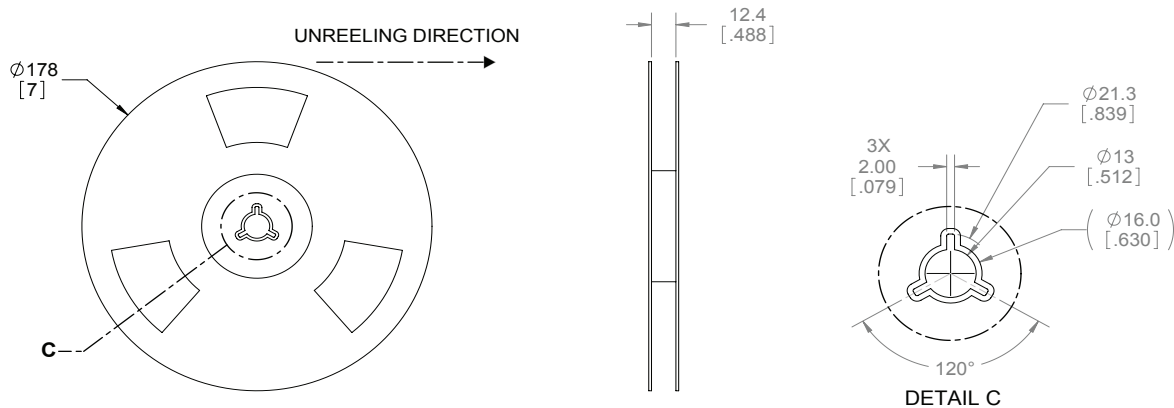

Mechanical Dimensions - B90 Package

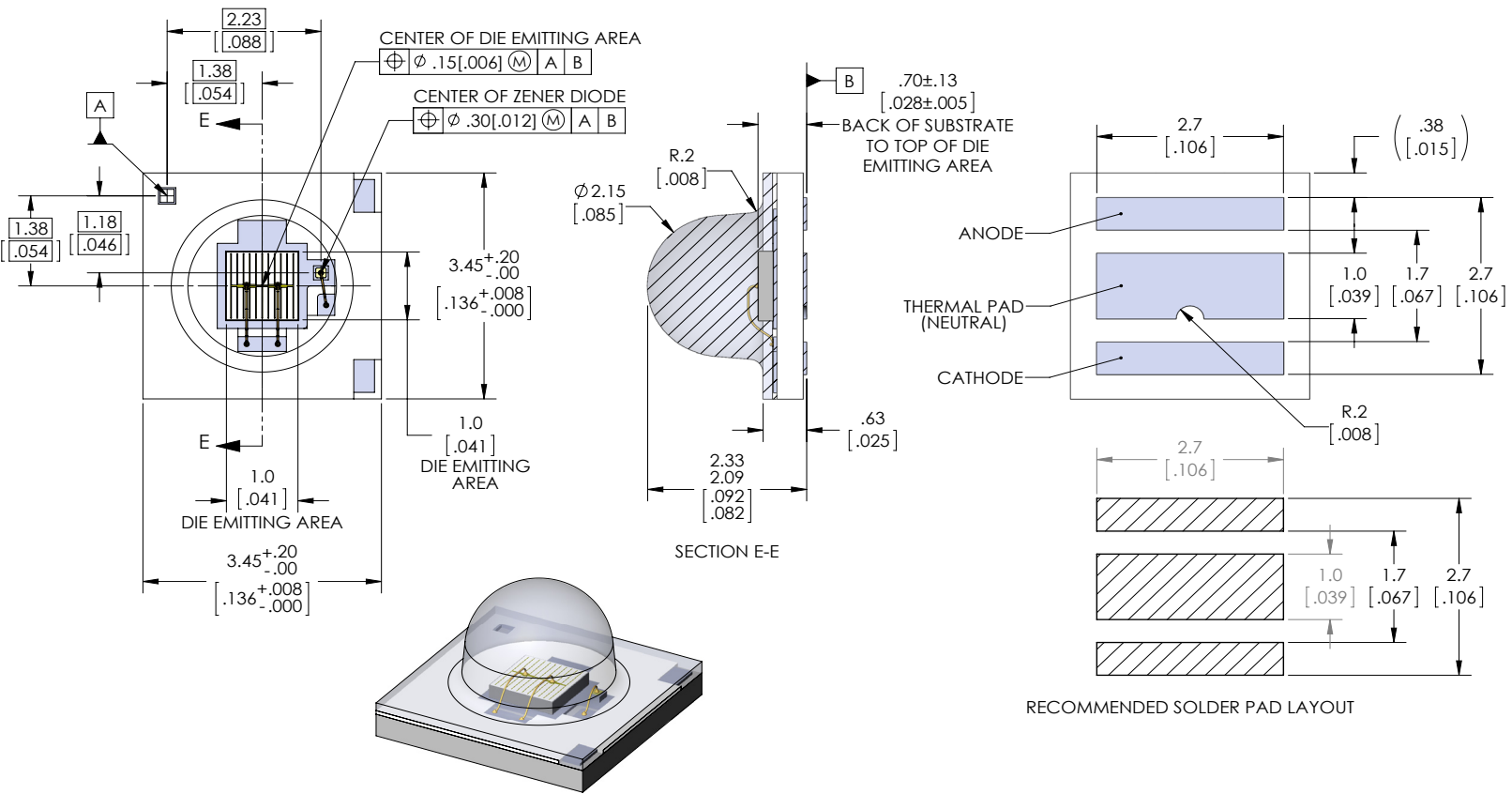

Tape and Reel - B90 Package

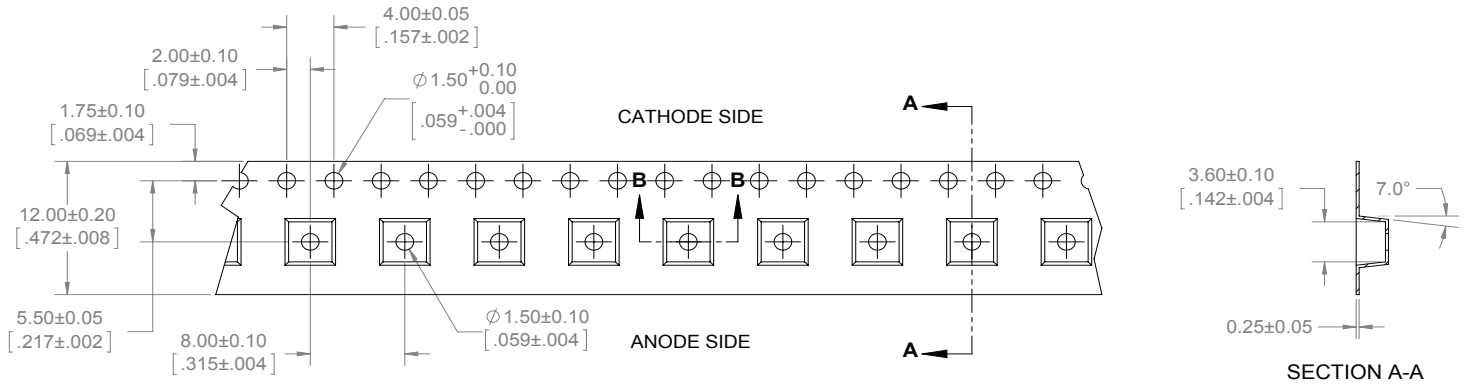

NOTES:

1. FINAL TAPE AND REEL PACKAGING MUST MEET THE REQUIREMENTS OF JEDEC-STD-033, LEVEL 2A.
2. LEAVE 304.8mm [12.00 in] OF TAPE EMPTY FOR LEAD IN (38 EMPTY POCKETS).
3. LEAVE 457.2mm [18.00 in] OF TAPE EMPTY FOR TRAILER (57 EMPTY POCKETS).
4. MUST COMPLY TO EIA-481-C-2003

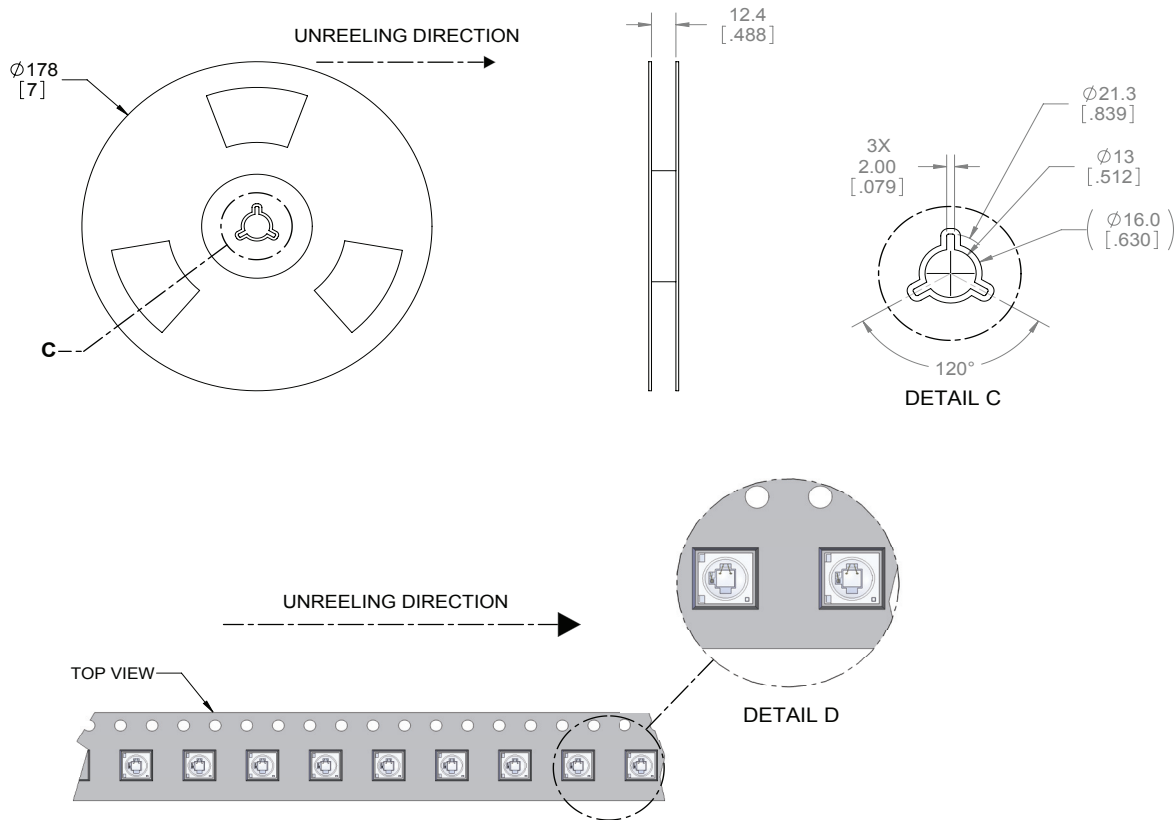

Soldering Profile

| Profile Feature | Sn-Pb Eutectic Assembly | Pb-Free Assembly |
|--|-------------------------|------------------|
| Preheat & Soak | 100 °C | 150 °C |
| Temperature min (T _{smin}) | 150 °C | 200 °C |
| Temperature max (T _{smax}) | 60-120 seconds | 60-120 seconds |
| Time (T _{smin} to T _{smax}) (t _s) | | |
| Average ramp-up rate (T _{smax} to T _p) | 3 °C/second max | 3 °C/second max |
| Liquidous temperature (T _L) | 183 °C | 217 °C |
| Time at liquidous (t _L) | 60-150 seconds | 60-150 seconds |
| Peak package body temperature (T _p)* | 230 °C ~235 °C | 255 °C ~260 °C |
| Classification temperature (T _c) | 235 °C | 260 °C |
| Time (t _p) within 5 °C of the specified classification temperature (T _c) | 20 seconds | 30 seconds |
| Average ramp-down rate (T _p to T _{smax}) | 6 °C/second max | 6 °C/second max |
| Time 25 °C to peak temperature | 6 minutes max | 8 minutes max |

* Tolerance for peak profile temperature(T_p) is defined as a supplier minimum and a user maximum.

** Tolerance for time at peak profile temperature(t_p) is defined as a supplier minimum and a user maximum.

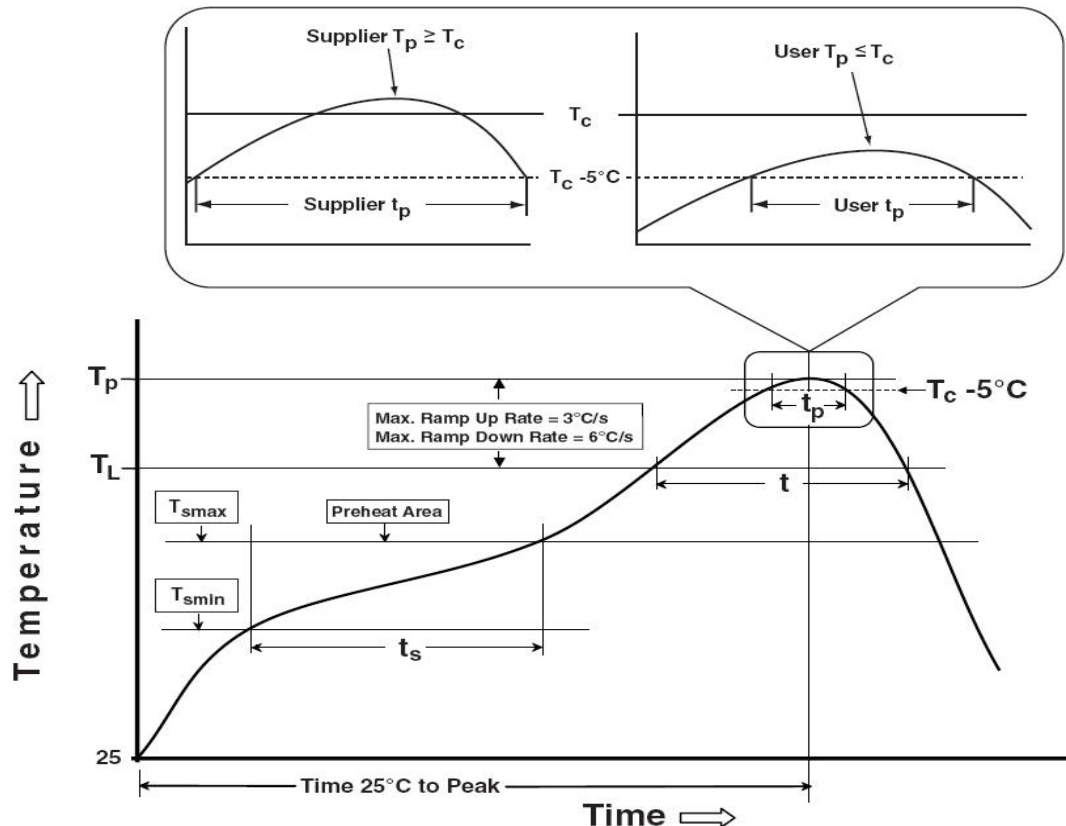

Precautions for Use

Storage:

1. Before opening the package

The LEDs should be kept at <40 & $<90\%RH$. The LEDs should be used within a year. When storing the LEDs, moisture proof package with absorbent material (silica gel) is recommended.

2. After opening the package

The LEDs should be kept at ≤ 30 & $\leq 60\%RH$. The LEDs should be soldered within 168 hours (7days) after opening the moisture proof package.

If unused LEDs remain, they should be stored in moisture proof packages, such as sealed containers with moisture proof package within absorbent material (silica gel). It is also recommended to return the unused LEDs to the original moisture proof package and to seal the moisture proof package again.

If the moisture absorbent material (silica gel) vapors or expires the expiration date, baking treatment should be performed by using the following conditions : 60 °C for 20 hours.

The LEDs electrode and leadframe comprise a silver plated copper alloy. The silver surface may be affected by environments. Please avoid conditions which may cause the LEDs being corroded or discolored. The corrosion or discoloration might lower solderability or affect optical characteristics.

Please avoid rapid transition in ambient temperature, especially in high humidity environments where condensation can occur.

Static Electricity:

1. The products are sensitive to static electricity, and care should be taken when handling them.

2. Static electricity or surge voltage will damage the LEDs. It is recommended to wear a anti-electrostatic wristband or an anti-electrostatic gloves when handling the LEDs.

3. All devices, equipment and machinery must be properly grounded. It is recommended that measures be taken against surge voltage to the equipment that mounts the LEDs.

History of Changes

| Rev | Date | Description of Change |
|-----|------------|--|
| 01 | 01/13/2016 | Initial Release |
| 02 | 03/28/2016 | Updated Binning and Angular Distribution Data, Added 90deg Tape and Reel |
| | | |
| | | |
| | | |

The products, their specifications and other information appearing in this document are subject to change by Luminus Devices without notice. Luminus Devices assumes no liability for errors that may appear in this document, and no liability otherwise arising from the application or use of the product or information contained herein. None of the information provided herein should be considered to be a representation of the fitness or suitability of the product for any particular application or as any other form of warranty. Luminus Devices' product warranties are limited to only such warranties as accompany a purchase contract or purchase order for such products. Nothing herein is to be construed as constituting an additional warranty. No information contained in this publication may be considered as a waiver by Luminus Devices of any intellectual property rights that Luminus Devices may have in such information. Big Chip LEDs™ is a registered trademark of Luminus Devices, Inc., all rights reserved.

This product is protected by U.S. Patents 6,831,302; 7,074,631; 7,083,993; 7,084,434; 7,098,589; 7,105,861; 7,138,666; 7,166,870; 7,166,871; 7,170,100; 7,196,354; 7,211,831; 7,262,550; 7,274,043; 7,301,271; 7,341,880; 7,344,903; 7,345,416; 7,348,603; 7,388,233; 7,391,059 Patents Pending in the U.S. and other countries.

Компания «Life Electronics» занимается поставками электронных компонентов импортного и отечественного производства от производителей и со складов крупных дистрибьюторов Европы, Америки и Азии.

С конца 2013 года компания активно расширяет линейку поставок компонентов по направлению коаксиальный кабель, кварцевые генераторы и конденсаторы (керамические, пленочные, электролитические), за счёт заключения дистрибьюторских договоров

Мы предлагаем:

- Конкуренеспособные цены и скидки постоянным клиентам.
- Специальные условия для постоянных клиентов.
- Подбор аналогов.
- Поставку компонентов в любых объемах, удовлетворяющих вашим потребностям.
- Приемлемые сроки поставки, возможна ускоренная поставка.
- Доставку товара в любую точку России и стран СНГ.
- Комплексную поставку.
- Работу по проектам и поставку образцов.
- Формирование склада под заказчика.
- Сертификаты соответствия на поставляемую продукцию (по желанию клиента).
- Тестирование поставляемой продукции.
- Поставку компонентов, требующих военную и космическую приемку.
- Входной контроль качества.
- Наличие сертификата ISO.

В составе нашей компании организован Конструкторский отдел, призванный помогать разработчикам, и инженерам.

Конструкторский отдел помогает осуществить:

- Регистрацию проекта у производителя компонентов.
- Техническую поддержку проекта.
- Защиту от снятия компонента с производства.
- Оценку стоимости проекта по компонентам.
- Изготовление тестовой платы монтаж и пусконаладочные работы.



Тел: +7 (812) 336 43 04 (многоканальный)

Email: org@lifeelectronics.ru