

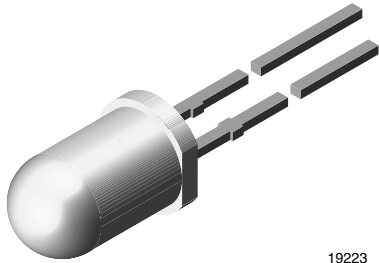

High Intensity LED, Ø 5 mm Untinted Non-Diffused Package



19223

DESCRIPTION

The TLH.51.. series is a clear, non diffused 5 mm LED for outdoor application.

These clear lamps utilize the highly developed technologies like AlInGaP and GaP.

The lens and the viewing angle is optimized to achieve best performance of light output and visibility.

FEATURES

- Untinted non-diffused lens
• Choice of three colors
• TLH.5100 for cost effective design
• Medium viewing angle
• Compliant to RoHS Directive 2011/65/EU and in accordance to WEEE 2002/96/EC



RoHS COMPLIANT

APPLICATIONS

- Outdoor LED panels
• Central high mounted stop lights (CHMSL) for motor vehicles
• Instrumentation and front panel indicators
• Light guide design
• Traffic signals

PRODUCT GROUP AND PACKAGE DATA

- Product group: LED
• Package: 5 mm
• Product series: standard
• Angle of half intensity: ± 9°

Table with 13 columns: PART, COLOR, LUMINOUS INTENSITY (mcd) [MIN., TYP., MAX.], at IF (mA), WAVELENGTH (nm) [MIN., TYP., MAX.], FORWARD VOLTAGE (V) [MIN., TYP., MAX.], at IF (mA), TECHNOLOGY. Rows include TLHK5100 (Red), TLHK5100-AS12Z (Red), TLHE5100 (Yellow), and TLHG5100 (Green).

Table with 5 columns: PARAMETER, TEST CONDITION, SYMBOL, VALUE, UNIT. Title: ABSOLUTE MAXIMUM RATINGS (T\_amb = 25 °C, unless otherwise specified) TLHK510., TLHE510., TLHG510. Rows include Reverse voltage, DC forward current, Surge forward current, Power dissipation, Junction temperature, Operating temperature range, Storage temperature range, Soldering temperature, Thermal resistance junction/ambient.

**OPTICAL AND ELECTRICAL CHARACTERISTICS** ( $T_{amb} = 25\text{ }^{\circ}\text{C}$ , unless otherwise specified)  
**TLHK510., RED**

PARAMETER	TEST CONDITION	SYMBOL	MIN.	TYP.	MAX.	UNIT
Luminous intensity <sup>(1)</sup>	$I_F = 20\text{ mA}$	$I_V$	320	1400	-	mcd
Dominant wavelength	$I_F = 10\text{ mA}$	$\lambda_d$	626	630	639	nm
Peak wavelength	$I_F = 10\text{ mA}$	$\lambda_p$	-	643	-	nm
Angle of half intensity	$I_F = 10\text{ mA}$	$\varphi$	-	$\pm 9$	-	deg
Forward voltage	$I_F = 20\text{ mA}$	$V_F$	-	2	2.6	V
Reverse voltage	$I_R = 10\text{ }\mu\text{A}$	$V_R$	5	-	-	V
Junction capacitance	$V_R = 0\text{ V}$ , $f = 1\text{ MHz}$	$C_j$	-	15	-	pF

**Note**(1) In one packing unit  $I_{Vmin.}/I_{Vmax.} \leq 0.5$ **OPTICAL AND ELECTRICAL CHARACTERISTICS** ( $T_{amb} = 25\text{ }^{\circ}\text{C}$ , unless otherwise specified)  
**TLHE510., YELLOW**

PARAMETER	TEST CONDITION	SYMBOL	MIN.	TYP.	MAX.	UNIT
Luminous intensity <sup>(1)</sup>	$I_F = 20\text{ mA}$	$I_V$	750	1800	-	mcd
Dominant wavelength	$I_F = 10\text{ mA}$	$\lambda_d$	581	588	594	nm
Peak wavelength	$I_F = 10\text{ mA}$	$\lambda_p$	-	590	-	nm
Angle of half intensity	$I_F = 10\text{ mA}$	$\varphi$	-	$\pm 9$	-	deg
Forward voltage	$I_F = 20\text{ mA}$	$V_F$	-	2	2.6	V
Reverse voltage	$I_R = 10\text{ }\mu\text{A}$	$V_R$	5	-	-	V
Junction capacitance	$V_R = 0\text{ V}$ , $f = 1\text{ MHz}$	$C_j$	-	15	-	pF

**Note**(1) In one packing unit  $I_{Vmin.}/I_{Vmax.} \leq 0.5$ **OPTICAL AND ELECTRICAL CHARACTERISTICS** ( $T_{amb} = 25\text{ }^{\circ}\text{C}$ , unless otherwise specified)  
**TLHG510., GREEN**

PARAMETER	TEST CONDITION	SYMBOL	MIN.	TYP.	MAX.	UNIT
Luminous intensity <sup>(1)</sup>	$I_F = 20\text{ mA}$	$I_V$	240	450	-	mcd
Dominant wavelength	$I_F = 10\text{ mA}$	$\lambda_d$	562	-	575	nm
Peak wavelength	$I_F = 10\text{ mA}$	$\lambda_p$	-	565	-	nm
Angle of half intensity	$I_F = 10\text{ mA}$	$\varphi$	-	$\pm 9$	-	deg
Forward voltage	$I_F = 20\text{ mA}$	$V_F$	-	2.4	3	V
Reverse voltage	$I_R = 10\text{ }\mu\text{A}$	$V_R$	6	15	-	V
Junction capacitance	$V_R = 0\text{ V}$ , $f = 1\text{ MHz}$	$C_j$	-	50	-	pF

**Note**(1) In one packing unit  $I_{Vmin.}/I_{Vmax.} \leq 0.5$



LUMINOUS INTENSITY CLASSIFICATION		
GROUP	LIGHT INTENSITY (mcd)	
	MIN.	MAX.
Z	240	480
AA	320	640
BB	430	860
CC	575	1150
DD	750	1500
EE	1000	2000
FF	1350	2700
GG	1800	3600
HH	2400	4800
II	3200	6400
KK	4300	8600

**Note**

- Luminous intensity is tested at a current pulse duration of 25 ms. The above type numbers represent the order groups which include only a few brightness groups. Only one group will be shipped on each bag (there will be no mixing of two groups on each bag). In order to ensure availability, single brightness groups will not be orderable. In a similar manner for colors where wavelength groups are measured and binned, single wavelength groups will be shipped in any one bag. In order to ensure availability, single wavelength groups will not be orderable.

COLOR CLASSIFICATION				
GROUP	DOM. WAVELENGTH (nm)			
	YELLOW		GREEN	
	MIN.	MAX.	MIN.	MAX.
0				
1	581	584		
2	583	586		
3	585	588	562	565
4	587	590	564	567
5	589	592	566	569
6	591	594	568	571
7			570	573
8			572	575

**Note**

- Wavelengths are tested at a current pulse duration of 25 ms.

**TYPICAL CHARACTERISTICS** ( $T_{amb} = 25\text{ }^{\circ}\text{C}$ , unless otherwise specified)

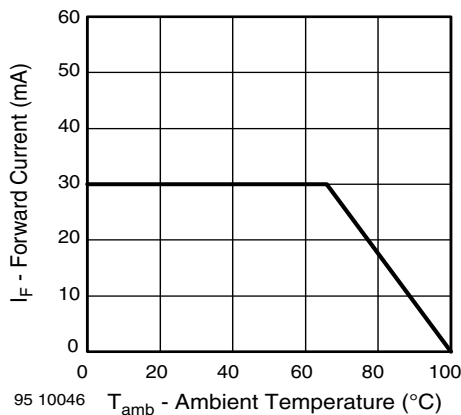

Fig. 1 - Forward Current vs. Ambient Temperature

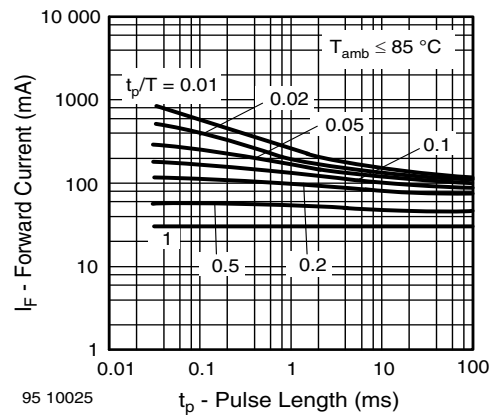

Fig. 2 - Forward Current vs. Pulse Length

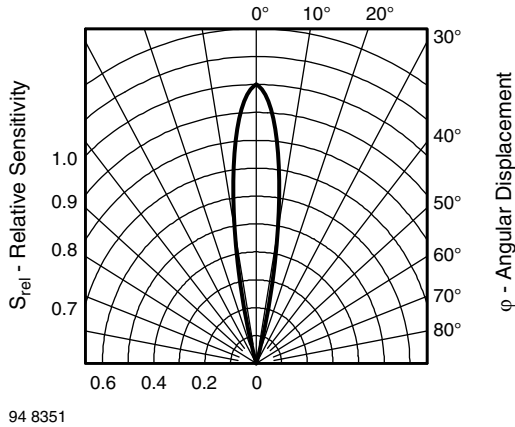

Fig. 3 - Relative Radiant Sensitivity vs. Angular Displacement

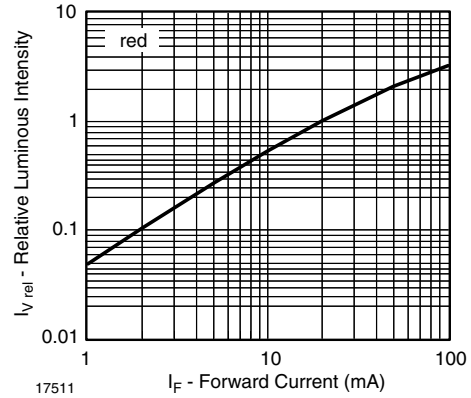

Fig. 6 - Relative Luminous Intensity vs. Forward Current

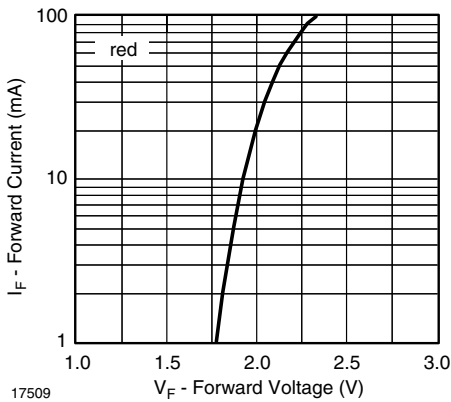

Fig. 4 - Forward Current vs. Forward Voltage

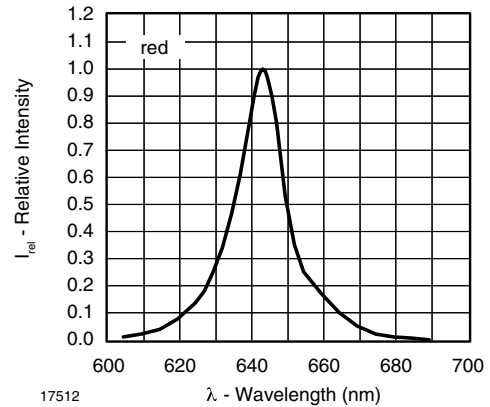

Fig. 7 - Relative Intensity vs. Wavelength

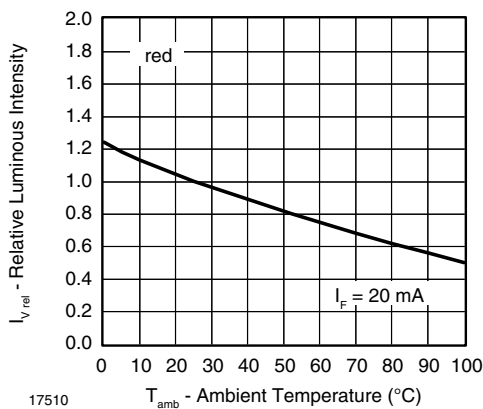

Fig. 5 - Relative Luminous Intensity vs. Ambient Temperature

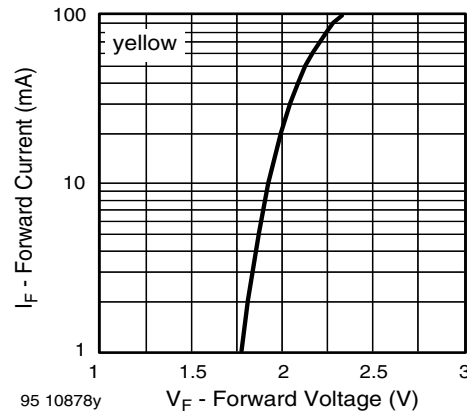

Fig. 8 - Forward Current vs. Forward Voltage

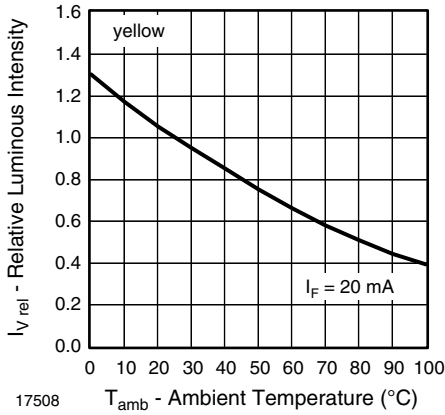

Fig. 9 - Relative Luminous Intensity vs. Ambient Temperature

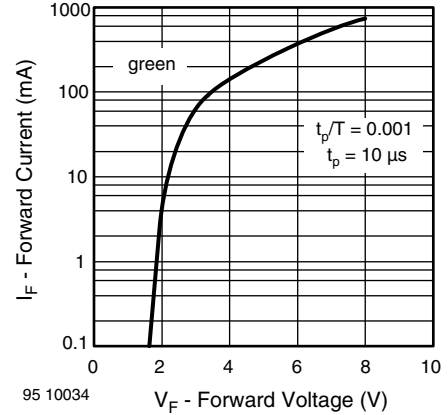

Fig. 12 - Forward Current vs. Forward Voltage

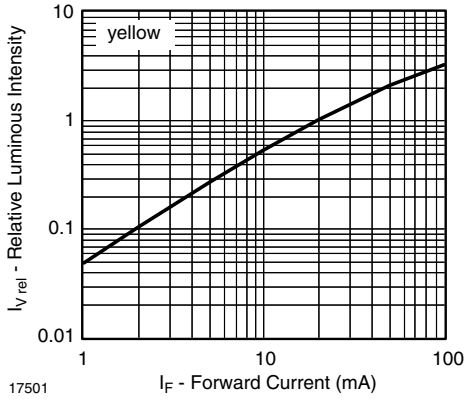

Fig. 10 - Relative Luminous Intensity vs. Forward Current

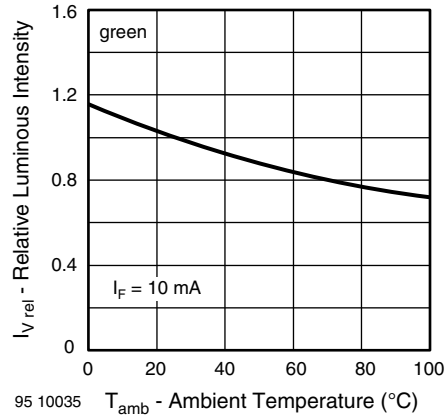

Fig. 13 - Relative Luminous Intensity vs. Ambient Temperature

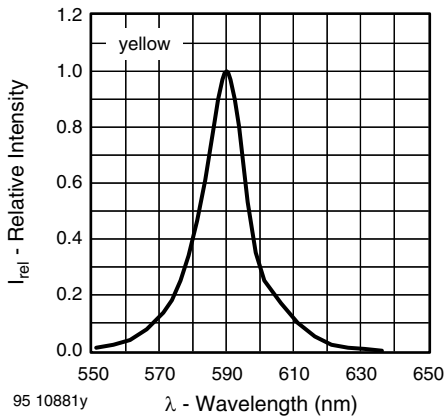

Fig. 11 - Relative Intensity vs. Wavelength

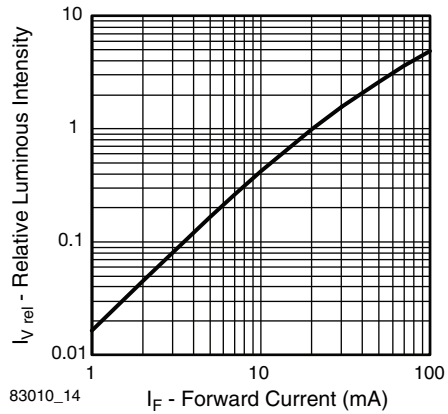

Fig. 14 - Relative Luminous Intensity vs. Forward Current

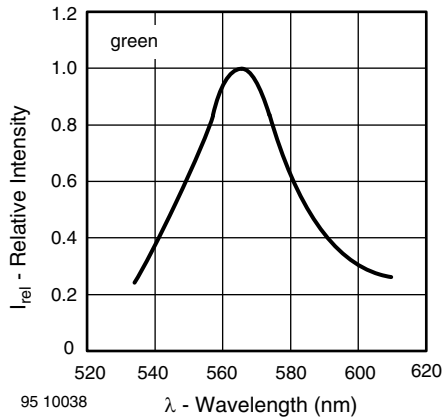
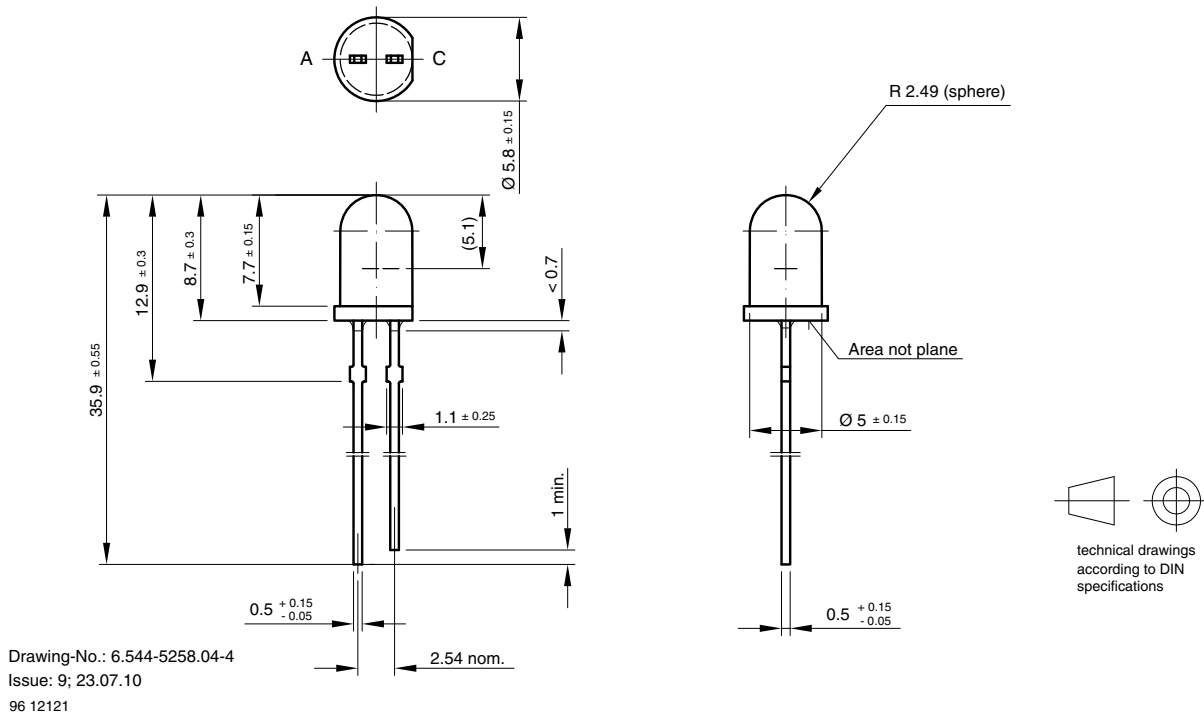

Fig. 15 - Relative Intensity vs. Wavelength

**PACKAGE DIMENSIONS** in millimeters





**AMMOPACK**

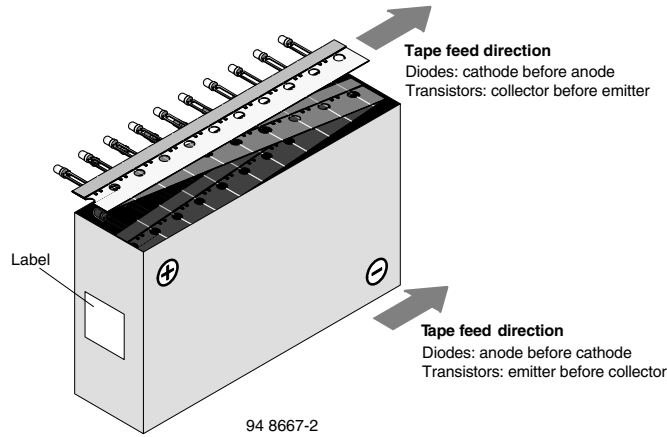
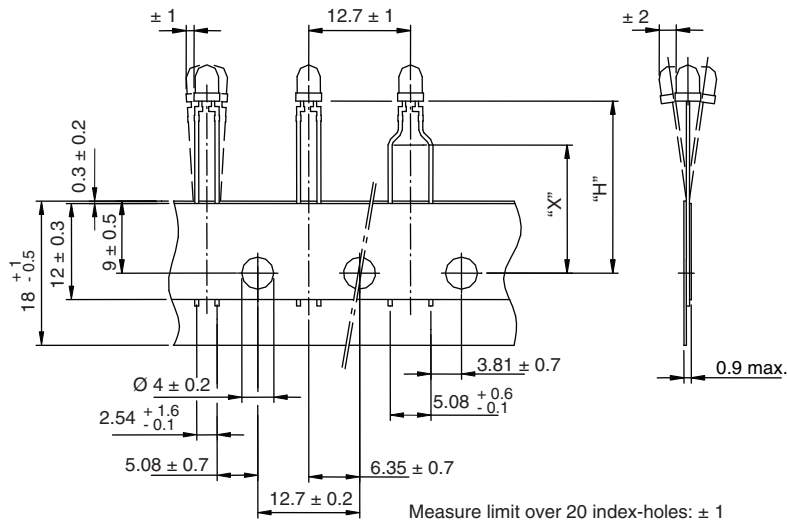

Fig. 16 - Tape Direction

**Note**

- The new nomenclature for ammpack is ASZ only, without suffix for the LED orientation. The carton box has to be turned to the desired position: "+" for anode first, or "-" for cathode first. AS12Z and AS21Z are still valid for already existing types, BUT NOT FOR NEW DESIGN.

**TAPE DIMENSIONS** in millimeters



Quantity per:	Reel (Mat.-no. 1764)
	2000

21885

OPTION	DIMENSION "H" ± 0.5 mm	DIMENSION "X" ± 0.5 mm
AS	17.3	-



## Disclaimer

ALL PRODUCT, PRODUCT SPECIFICATIONS AND DATA ARE SUBJECT TO CHANGE WITHOUT NOTICE TO IMPROVE RELIABILITY, FUNCTION OR DESIGN OR OTHERWISE.

Vishay Intertechnology, Inc., its affiliates, agents, and employees, and all persons acting on its or their behalf (collectively, "Vishay"), disclaim any and all liability for any errors, inaccuracies or incompleteness contained in any datasheet or in any other disclosure relating to any product.

Vishay makes no warranty, representation or guarantee regarding the suitability of the products for any particular purpose or the continuing production of any product. To the maximum extent permitted by applicable law, Vishay disclaims (i) any and all liability arising out of the application or use of any product, (ii) any and all liability, including without limitation special, consequential or incidental damages, and (iii) any and all implied warranties, including warranties of fitness for particular purpose, non-infringement and merchantability.

Statements regarding the suitability of products for certain types of applications are based on Vishay's knowledge of typical requirements that are often placed on Vishay products in generic applications. Such statements are not binding statements about the suitability of products for a particular application. It is the customer's responsibility to validate that a particular product with the properties described in the product specification is suitable for use in a particular application. Parameters provided in datasheets and/or specifications may vary in different applications and performance may vary over time. All operating parameters, including typical parameters, must be validated for each customer application by the customer's technical experts. Product specifications do not expand or otherwise modify Vishay's terms and conditions of purchase, including but not limited to the warranty expressed therein.

Except as expressly indicated in writing, Vishay products are not designed for use in medical, life-saving, or life-sustaining applications or for any other application in which the failure of the Vishay product could result in personal injury or death. Customers using or selling Vishay products not expressly indicated for use in such applications do so at their own risk. Please contact authorized Vishay personnel to obtain written terms and conditions regarding products designed for such applications.

No license, express or implied, by estoppel or otherwise, to any intellectual property rights is granted by this document or by any conduct of Vishay. Product names and markings noted herein may be trademarks of their respective owners.

## Material Category Policy

**Vishay Intertechnology, Inc. hereby certifies that all its products that are identified as RoHS-Compliant fulfill the definitions and restrictions defined under Directive 2011/65/EU of The European Parliament and of the Council of June 8, 2011 on the restriction of the use of certain hazardous substances in electrical and electronic equipment (EEE) - recast, unless otherwise specified as non-compliant.**

**Please note that some Vishay documentation may still make reference to RoHS Directive 2002/95/EC. We confirm that all the products identified as being compliant to Directive 2002/95/EC conform to Directive 2011/65/EU.**

**Vishay Intertechnology, Inc. hereby certifies that all its products that are identified as Halogen-Free follow Halogen-Free requirements as per JEDEC JS709A standards. Please note that some Vishay documentation may still make reference to the IEC 61249-2-21 definition. We confirm that all the products identified as being compliant to IEC 61249-2-21 conform to JEDEC JS709A standards.**



Компания «Life Electronics» занимается поставками электронных компонентов импортного и отечественного производства от производителей и со складов крупных дистрибьюторов Европы, Америки и Азии.

С конца 2013 года компания активно расширяет линейку поставок компонентов по направлению коаксиальный кабель, кварцевые генераторы и конденсаторы (керамические, пленочные, электролитические), за счёт заключения дистрибьюторских договоров

Мы предлагаем:

- Конкуренспособные цены и скидки постоянным клиентам.
- Специальные условия для постоянных клиентов.
- Подбор аналогов.
- Поставку компонентов в любых объемах, удовлетворяющих вашим потребностям.
- Приемлемые сроки поставки, возможна ускоренная поставка.
- Доставку товара в любую точку России и стран СНГ.
- Комплексную поставку.
- Работу по проектам и поставку образцов.
- Формирование склада под заказчика.
- Сертификаты соответствия на поставляемую продукцию (по желанию клиента).
- Тестирование поставляемой продукции.
- Поставку компонентов, требующих военную и космическую приемку.
- Входной контроль качества.
- Наличие сертификата ISO.

В составе нашей компании организован Конструкторский отдел, призванный помогать разработчикам, и инженерам.

Конструкторский отдел помогает осуществить:

- Регистрацию проекта у производителя компонентов.
- Техническую поддержку проекта.
- Защиту от снятия компонента с производства.
- Оценку стоимости проекта по компонентам.
- Изготовление тестовой платы монтаж и пусконаладочные работы.



Тел: +7 (812) 336 43 04 (многоканальный)  
Email: org@lifeelectronics.ru