



MAIN FEATURES

- Specifically designed for leadfree reflow soldering processes (excellent performance).
- Cermet resistive element.
- IP54 protection according to IEC 60529.
- Plastic material according to UL94V-0.
- Alumina substrate.
- Full traceability.
- Also upon request:
 - Long life model for low cost control potentiometer applications.
 - Mechanical detents.
 - Low torque version.
 - Centering pins.
 - Wiper positioned at initial, 50% or fully clockwise.

MECHANICAL SPECIFICATIONS

- Mechanical life*: Up to 10K cycles.
- Mechanical rotation angle: $235^\circ \pm 5^\circ$
- Electrical rotation angle: $220^\circ \pm 20^\circ$
- Torque: 0.4 to 2 Ncm. (0.6 to 2.7 in-oz)
- Stop torque: > 5 Ncm. (> 7 in-oz)

ELECTRICAL SPECIFICATIONS

- Range of values*: $100\Omega \leq R_n \leq 5M\Omega$ (Decad. 1.0 - 2.0 - 2.2 - 2.5 - 4.7 - 5.0)
- Standard tolerance*: $100\Omega \leq R_n \leq 1M\Omega$ ----- $\pm 20\%$
 $1M\Omega \leq R_n \leq 5M\Omega$ ----- $\pm 30\%$
- Tapers*: Lin, Log, Alog (Log and Alog. only $R_n \geq 1K$).
- Nominal power: 0.33W @ 70°C (158°F)
- Operating temperature*: $-40^\circ C + 90^\circ C$
- Residual resistance: $\leq 0.5\% R_n$
- Equivalent noise resistance: $\leq 3\% R_n$
- Max. voltage: 200 VDC

* Others upon request

HOW TO ORDER

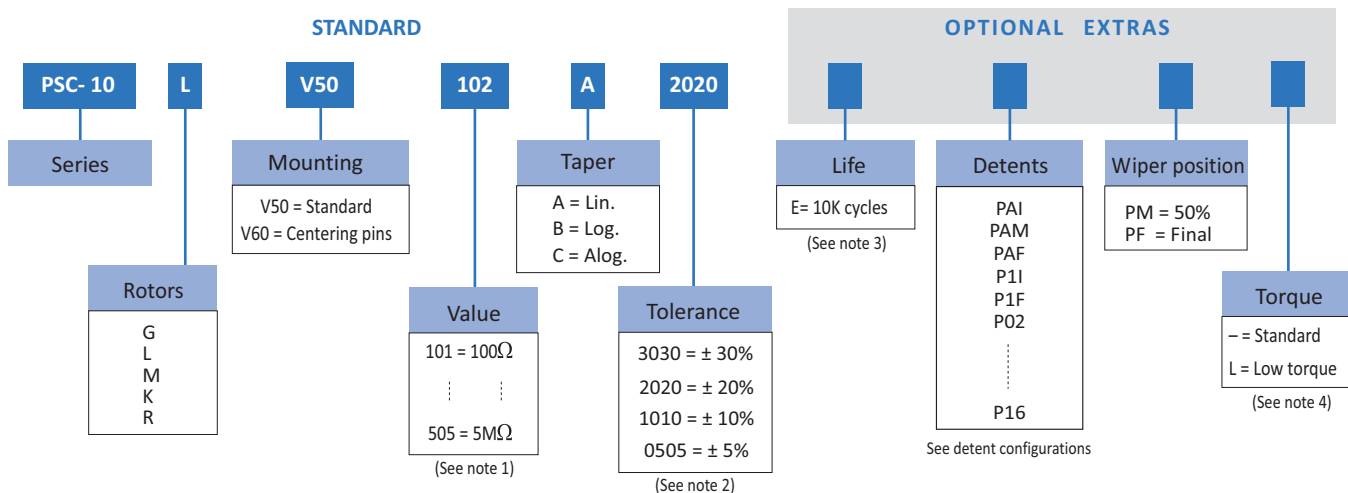

NOTES:

(1) Value Example: $\overset{10}{\text{---}} \overset{2}{\text{---}} = 1K\Omega$
 Number of zeros
 First two digits of the value.

(2) Non standard tolerance, upon request. Example: +17% -15%
 17 15
 negative tolerance
 positive tolerance

(3) Others upon request.

(4) Low torque: $\leq 1.5Ncm$. No detent option available for low torque models.

HOW TO ORDER CUSTOM DRAWING

PSC10MV50 + DRAWING NUMBER

This way of ordering should be used for options which are not included in the "How to order" standard and optional extras.

STANDARD OPTIONS

Mechanical life	1000 cycles
Detents	None
Rotor colour	Brown
Housing colour	Brown
Wiper position	Initial
Torque	Standard
Packaging	Reel

ROTORS (collector side view)

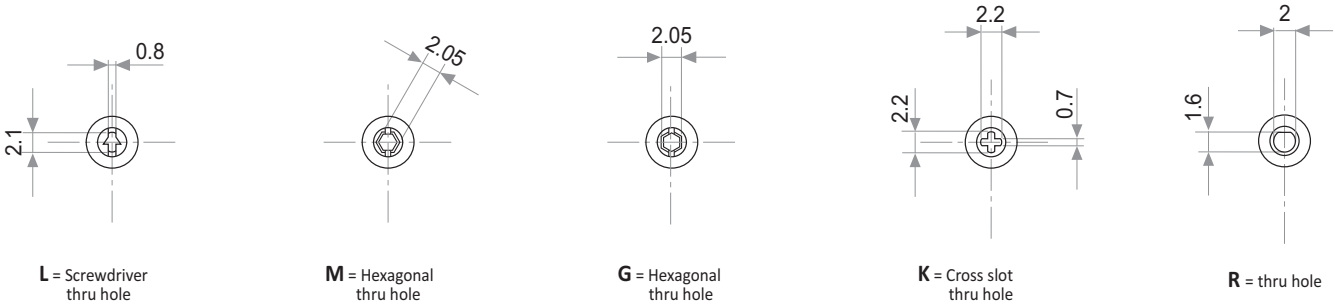

Note: wipers shown positioned at 50%

DIMENSIONS (V50 version)

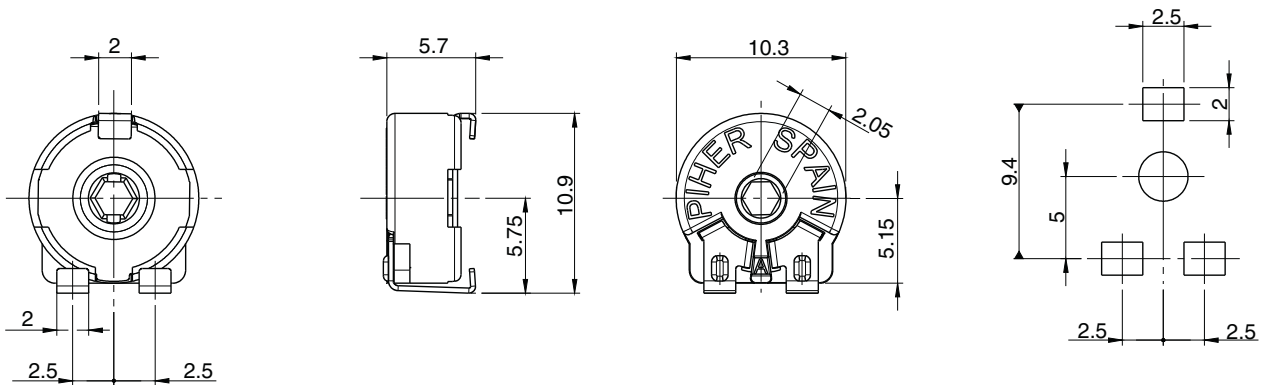

DIMENSIONS (V60 version - with centering pins)

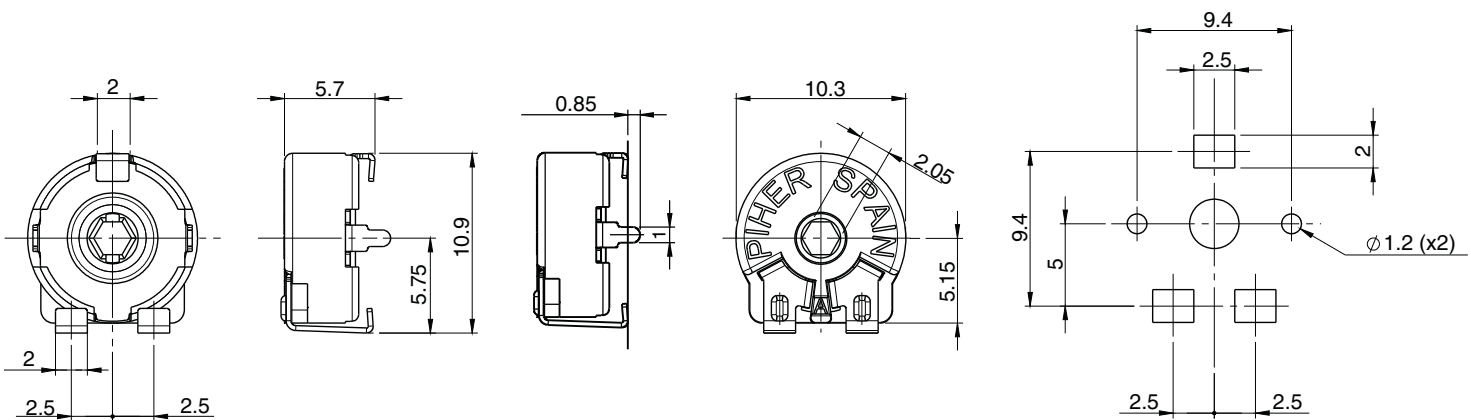

OPTIONS

Positioning (Std. Position = CCW)

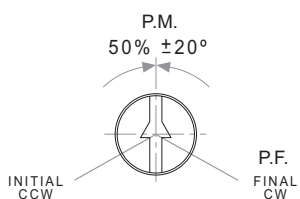

RECOMMENDED REFLOW PROFILE

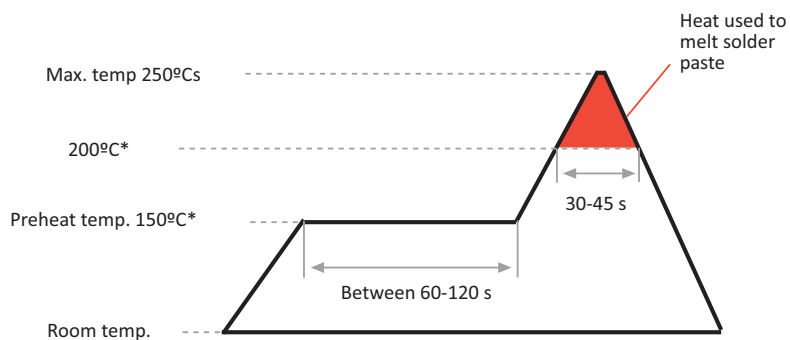

* Melting point temp. depends on solder properties

TESTS

TYPICAL VARIATIONS

ELECTRICAL LIFE	1000 h. @ 70°C; 0.33 W	±5 %
MECHANICAL LIFE (CYCLES)	1000 @ 10 CPM ...15 CPM	±3 % (Rn < 1 MΩ)
TEMPERATURE COEFFICIENT	-40°C; +90°C	±100 ppm (Rn <100 K)
THERMAL CYCLING	16 h. @ 90°C; 2h. @ -40°C	±2.5 %
DAMP HEAT	500 h. @ 40°C @ 95% HR	±5 %
VIBRATION (for each plane X,Y,Z)	2 h. @ 10 Hz. ... 55 Hz.	±2 %

NOTE: Out of range values may not comply these results.

PACKAGING

BULK: 500pcs / per Box (80 x 85 x 185 mm.)

EMBOSSED TAPE: 500pcs / Reel

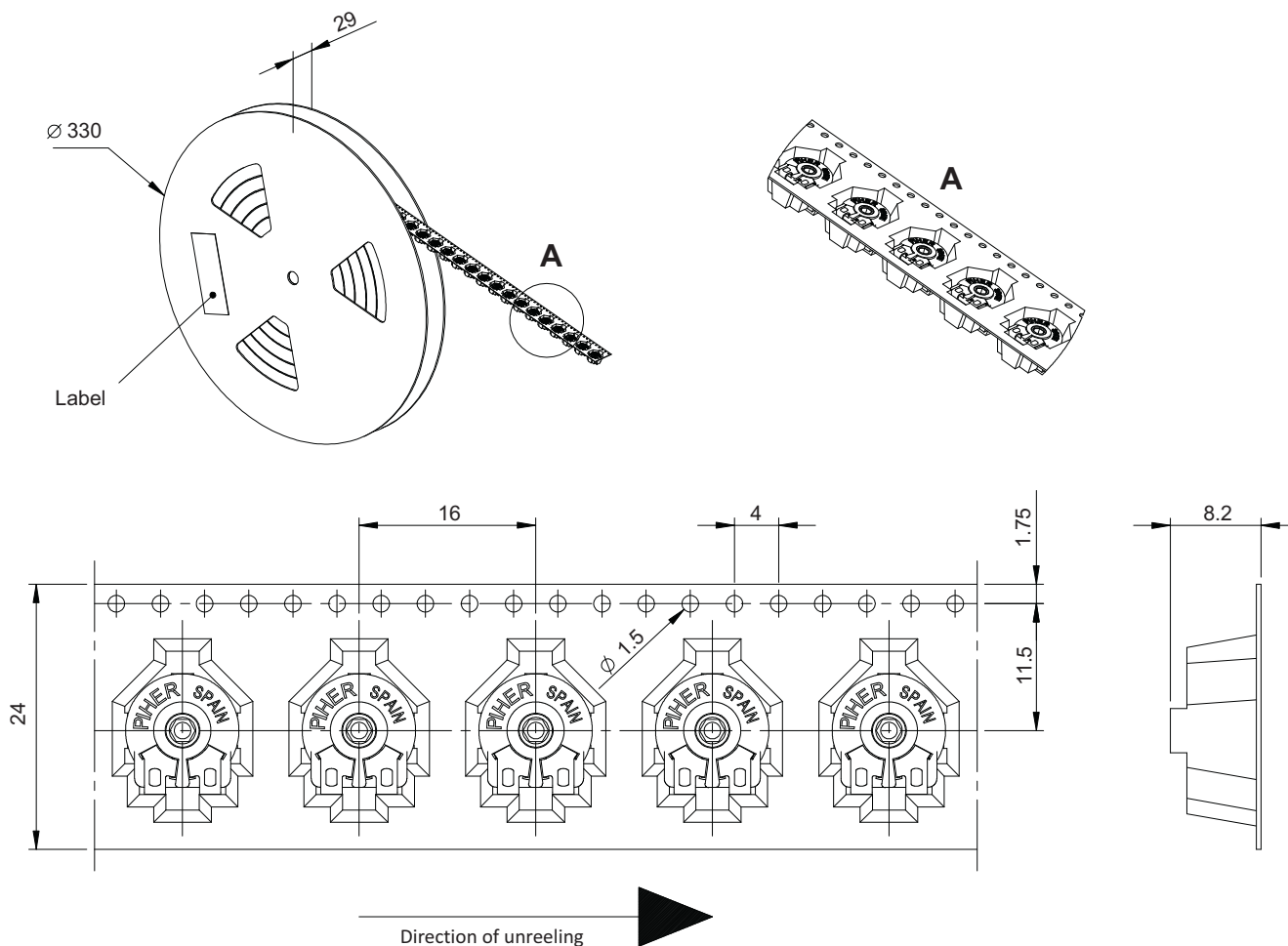

STANDARD VALUES AND TOLERANCES

Resistance Ω	100	200	220	250	470	500	1K	2K	2.2K	2.5K	4.7K	5K	10K	20K	22K	25K	47K	50K	100K	200K	220K	250K	470K	500K	1M	2M	2.5M	4.7M	5M		
How to order code	101	201	221	251	471	501	102	202	222	252	472	502	103	203	223	253	473	503	104	204	224	254	474	504	105	205	255	475	505		
Standard tolerance	20%																								30%						
(Others upon request)																															

TAPERS

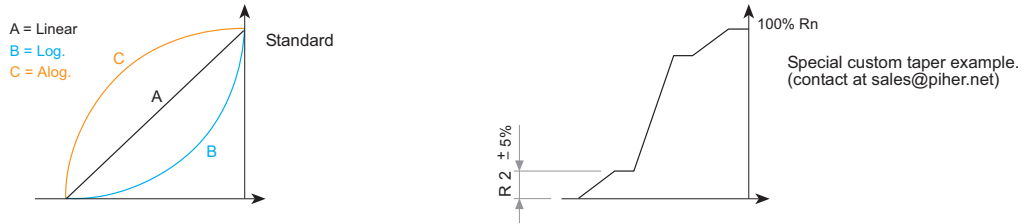

DETENT CONFIGURATIONS EXAMPLES - Stepped potentiometers.

This innovative product family has been specifically developed to allow the integration of otherwise large and expensive external mechanisms into the body of the majority of the 10 & 15 mm. PS/PSX/PSC/PT/PTC potentiometer series, thus allowing a high range of configurations: special tapers, tolerances, linearity, etc.

This detent design not only adds a "click" sensation of position, but also offers enormous savings in both cost and space for any given application.

Strong and weak detents can be mixed as per customer's request.

Detent number and positions can be made or fitted to the customer needs or preferences.

Relative detent (steps) positions along the total mechanical travel. Unless otherwise specified the detents are evenly spaced (using the end points as reference)

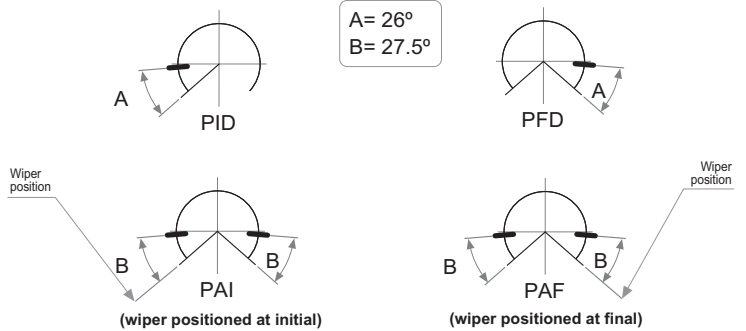
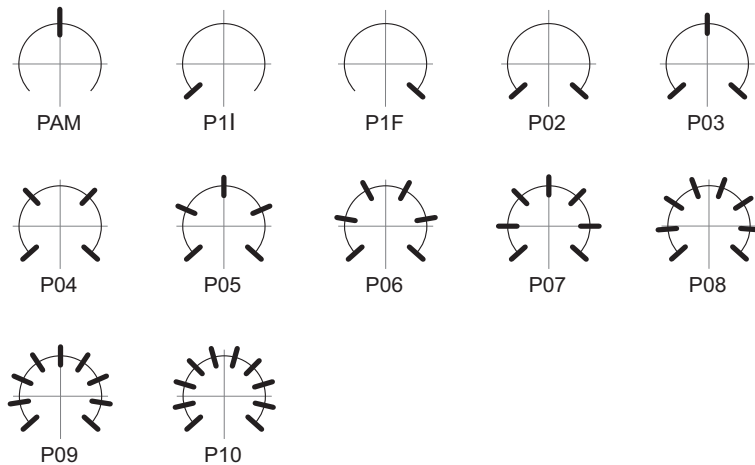

NOTES FOR DETENTED VERSIONS:

- Some configurations may have a longer leadtime.
- Standard mechanical life is 500 cycles.
- Long life versions are available under request and have the following characteristics at T₃:
 - Potentiometers with 1 to 3 detents: up to 10K cycles
 - Potentiometers with 4 and more detents: up to 5K cycles
- Detent torque can vary from 1.2 to 2.5 times the standard potentiometer torque.
- Please consult your nearest Piher supplier if unique non-overlapping values at each detent position or LOG/ALOG tapers are required.
- Different output voltage values can be matched at each detent position (under request).

PSC-10 with 10 detents and silver zones

upon request

Detents can be matched with constant value zones when required.

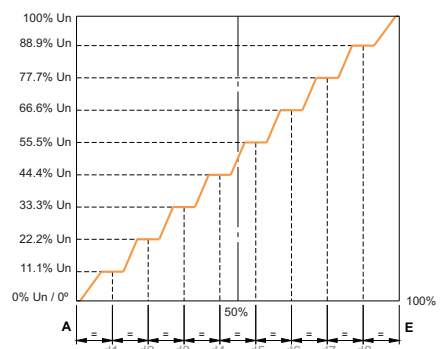
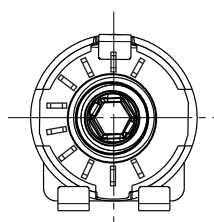
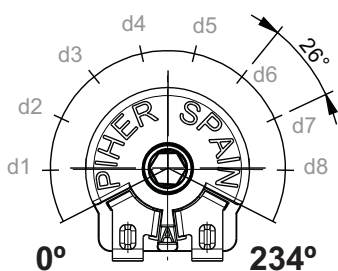

SHAFTS (for G and M rotor types, top view)

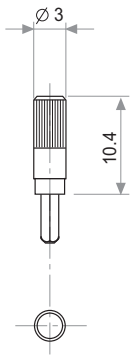

Fig. 1 / Ref. 5016

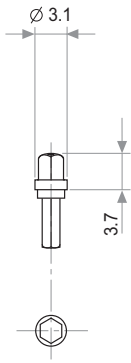

Fig. 2 / Ref. 5053

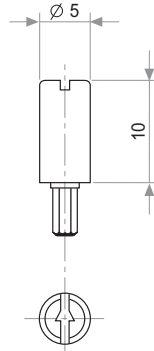

Fig. 3 / Ref. 5012

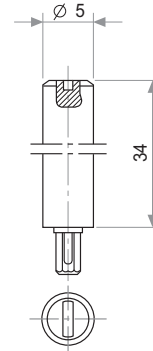

Fig. 4 / Ref. 6053

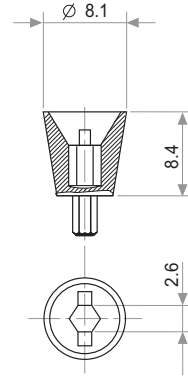

Fig. 6 / Ref. 5035

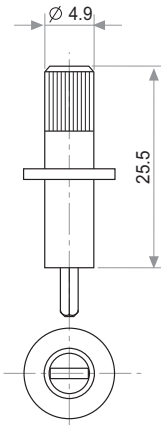

Fig. 7 / Ref. 5115

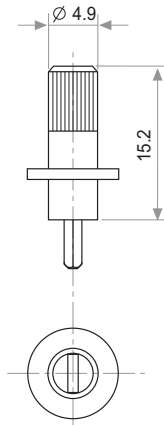

Fig. 8 / Ref. 5116

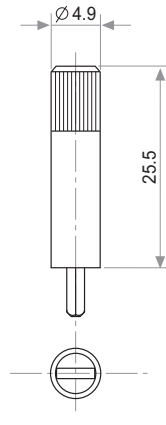

Fig. 9 / Ref. 5119

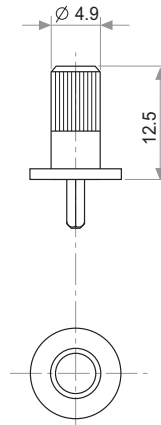

Fig. 10 / Ref. 5120

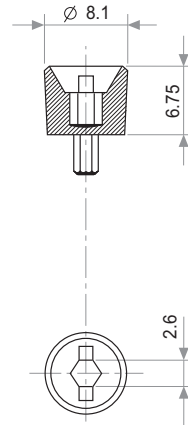

Fig. 11 / Ref. 5027

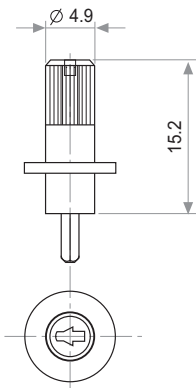

Fig. 12 / Ref. 6052

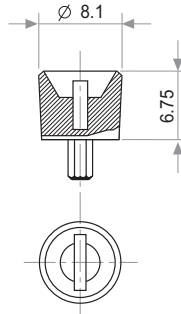

Fig. 13 / Ref. 5121

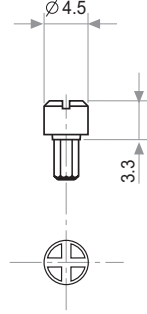

Fig. 14 / Ref. 5055

Shafts, knobs and thumbwheels are delivered unassembled. If you wish to use your own custom plastic shaft/knob/actuator please contact Piher for advice about compatible materials.

THUMBWHEELS (for G and M rotor types, top view)

THUMBWHEEL For R rotor type only

Marking: configurable number of positions.

Example of four positions marking:

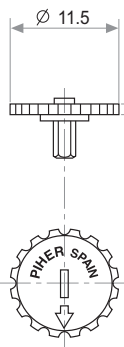

Fig. 5 / Ref. 5034

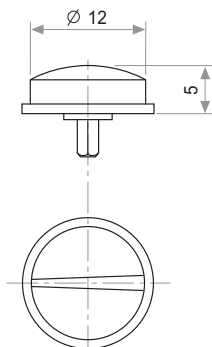

Fig. 15 / Ref. 6008

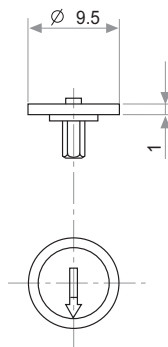

Fig. 16 / Ref. 5039

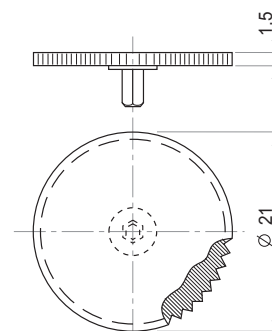
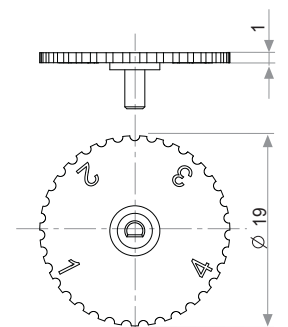

Fig. 17 / Ref. 5062



Upon request

RECOMMENDED CONNECTIONS

Piher potentiometer's recommended connection circuit for a position sensor or control application. (voltage divider circuit electronic design).

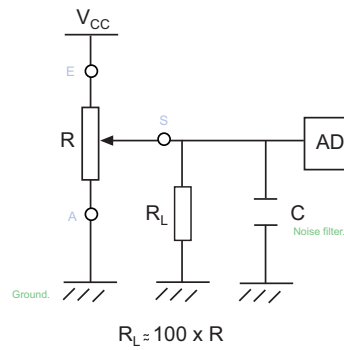

The product information in this catalogue is for reference purposes. Please consult for the most up to date and accurate design information.

Piher Sensors & Controls S.A., its affiliates, agents, and employees, and all persons acting on its or their behalf (collectively, "Piher"), disclaim any and all liability for any errors, inaccuracies or incompleteness contained herein or in any other disclosure relating to any product described herein.

Piher disclaims any and all liability arising out of the use or application of any product described herein or of any information provided herein to the maximum extent permitted by law. The product specifications do not expand or otherwise modify Piher's terms and conditions of sale, including but not limited to the warranty expressed therein, which apply to these products.

No licence, express or implied, by estoppel or otherwise, to any intellectual property rights is granted by this document or by any conduct of Piher.

The products shown herein are not designed for use in medical, life-saving, or life-sustaining applications unless otherwise expressly indicated. Customers using or selling Piher products not expressly indicated for use in such applications do so entirely at their own risk and agree to fully indemnify Piher for any damages arising or resulting from such use or sale. Please contact authorised Piher personnel to obtain written terms and conditions regarding products designed for such applications.

Product names and markings noted herein may be trademarks of their respective owners.

Information contained in and/or attached to this catalogue may be subject to export control regulations of the European Community, USA, or other countries. Each recipient of this document is responsible to ensure that usage and/or transfer of any information contained in this document complies with all relevant export control regulations. If you are in any doubt about the export control restrictions that apply to this information, please contact the sender immediately. For any Piher Exports, Note: All products / technologies are EAR99 Classified commodities. Exports from the United States are in accordance with the Export Administration Regulations. Diversion contrary to US law is prohibited.

Piher is an Amphenol™ company.

Contact

Piher Sensors & Controls SA
Polígono Industrial Municipal
Vial T2 Nº22
31500 Tudela - Spain
Tel: +34-948-820450

sales@piher.net

www.piher.net

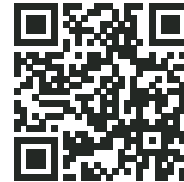

RoHS
compliant

All Piher products can be adapted to meet customer's requirements.
Due to continuous process improvement, specifications are subject to change without notice.
Please always use the datasheets published at our website www.piher.net for the most up-to-date information.

v160818

Компания «Life Electronics» занимается поставками электронных компонентов импортного и отечественного производства от производителей и со складов крупных дистрибьюторов Европы, Америки и Азии.

С конца 2013 года компания активно расширяет линейку поставок компонентов по направлению коаксиальный кабель, кварцевые генераторы и конденсаторы (керамические, пленочные, электролитические), за счёт заключения дистрибьюторских договоров

Мы предлагаем:

- Конкурентоспособные цены и скидки постоянным клиентам.
- Специальные условия для постоянных клиентов.
- Подбор аналогов.
- Поставку компонентов в любых объемах, удовлетворяющих вашим потребностям.
- Приемлемые сроки поставки, возможна ускоренная поставка.
- Доставку товара в любую точку России и стран СНГ.
- Комплексную поставку.
- Работу по проектам и поставку образцов.
- Формирование склада под заказчика.
- Сертификаты соответствия на поставляемую продукцию (по желанию клиента).
- Тестирование поставляемой продукции.
- Поставку компонентов, требующих военную и космическую приемку.
- Входной контроль качества.
- Наличие сертификата ISO.

В составе нашей компании организован Конструкторский отдел, призванный помогать разработчикам, и инженерам.

Конструкторский отдел помогает осуществить:

- Регистрацию проекта у производителя компонентов.
- Техническую поддержку проекта.
- Защиту от снятия компонента с производства.
- Оценку стоимости проекта по компонентам.
- Изготовление тестовой платы монтаж и пусконаладочные работы.



Тел: +7 (812) 336 43 04 (многоканальный)
Email: org@lifeelectronics.ru