

G-SERIES SERVO SYSTEM

Save space, save wiring, save time



» Compact size

» MECHATROLINK-II

» Enhanced performance

Compact in size big in features

Always with your application in mind, G-Series servo drives give you additional functionalities to develop your machines faster, more flexibly and more efficiently.

Improved speed response, a wider range of servomotors and intuitive and fast auto-tuning belong to the new features, making it suitable for many applications, and always with the expected Omron quality and support.

Key features and benefits:

- Pocket-size servo with smallest footprint 15 x 4 cm
- Auto-tuning for easy and quick start-up
- Built-in MECHATROLINK-II motion bus reduces cabling and allows remote servo configuration and diagnosis
- High starting torque: 300% for 3 secs.
- Positioning, speed or torque control
- Separate power and control power supply
- Fast and accurate positioning
- Servomotor range from 50 W to 1.5 kW
- Incremental and absolute encoder available
- Cylindrical and flat servo motors up to 3,000 rpm
- Compatible with SmartStep 2 servomotors
- Vibration suppression



Save space, save wiring, save time

From multiple cables...

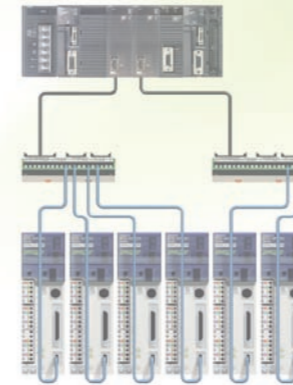

to only one cable

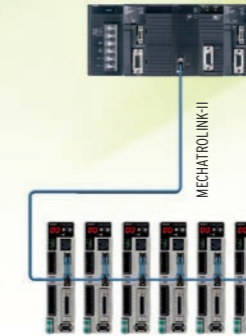

Easy connection: single cable only!

With their built-in MECHATROLINK-II motion bus, just a single cable is needed to connect servos together. So you not only save on wiring and installation time, you also significantly reduce the chance of connection errors. Reliability is increased since the single-cable connection is much more rugged than a multiple-wiring solution.

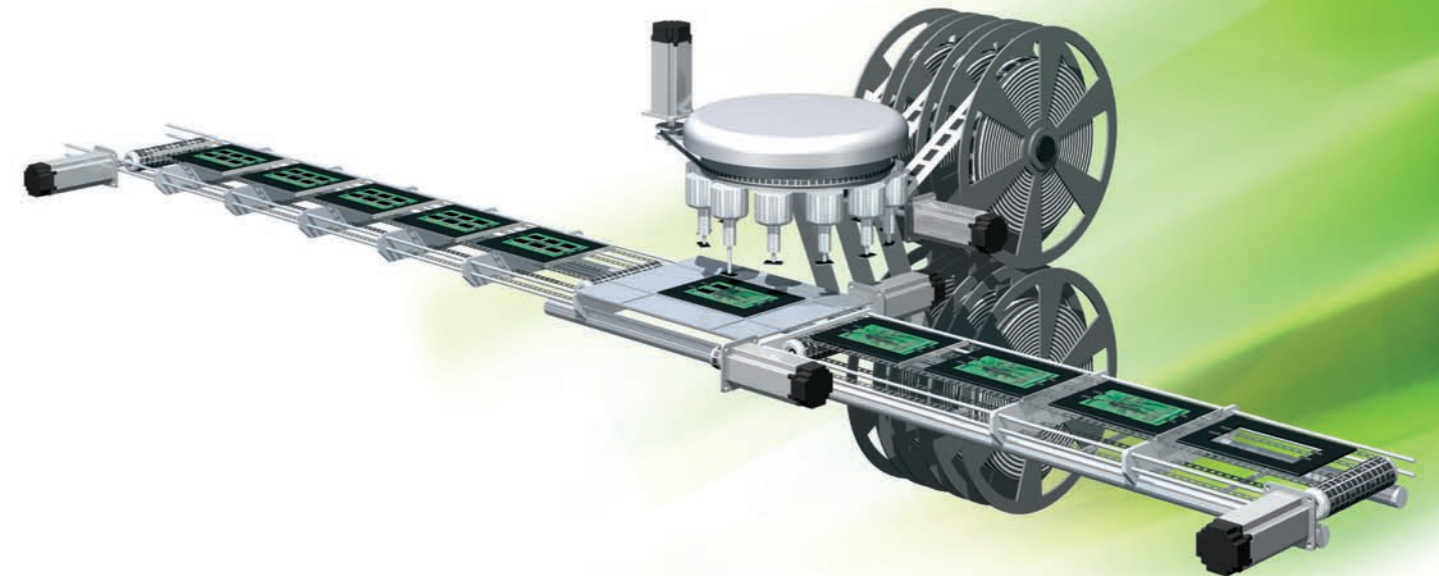

Fast and simple auto-tuning

The graphs show a move profile with a G-series servo in an application with an inertia ratio of 16:1. Tuning is possible via the easy to use CX-Drive, and takes just 1 minute to complete. The result is superb control, ensuring the servo and hence machine operates at its optimal point, with next to zero knowledge required from the user.

Once running, the on-board real time auto-tuning function takes care of the servo operation relative to the load inertia, again ensuring the quality of the finished produced part.

In addition, numerous suppression and notch filters are available to suppress machine vibration independent of machine direction.

Before auto-tuning



After auto-tuning

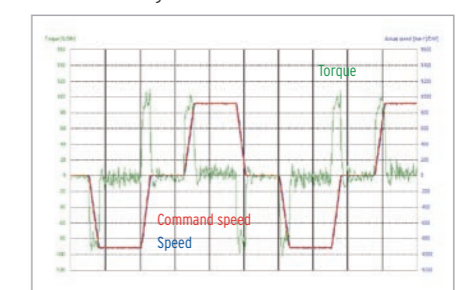

G-Series + NCF: Optimum positioning for up to 16 axes



Complete and compact positioning system

In a minimum of space you can have a complete and powerful PTP system when combining the CJ1W-NCF71 unit and the G-Series servo. This configuration offers 16-axis positioning with linear and circular interpolation, as well as interrupt feeding. The NCF and the G-Series offer the ideal solution for applications where space is tight.

Full transparency from a remote host

When the G-Series is controlled by NCF positioning unit, the servo drive is fully transparent to a remote PC. This is achieved over MECHATROLINK-II from the G-Series to the PLC and over any serial or Ethernet link between the PLC and PC. Hence complying fully with Omron Smart Platform.



PLCopen

A global standard for industrial control programming, PLCopen provides a standardized programming interface to harmonize the way people design and operate industrial control.

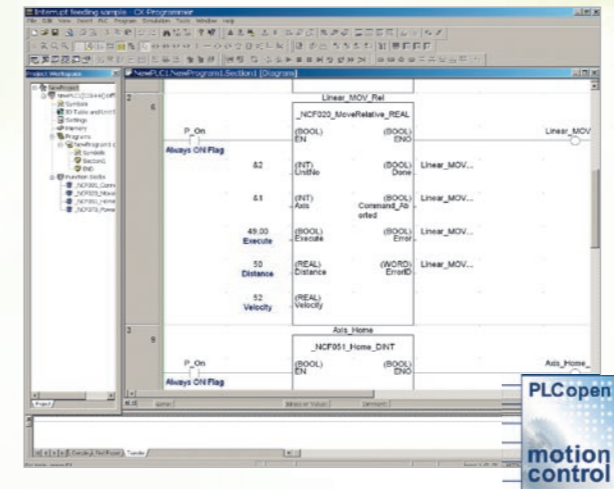

NCF - key features and benefits

- 16 axes, point-to-point positioning over ML II
- System scalability with models for 2, 4 and 16 axes
- Easy, quick and reliable setup
- Optimized for positioning applications
- Simplified wiring to drives
- Integration with Omron Smart Platform



R88D-GN□/R88M-G□

G-Series servo system

Compact in size big in features. Save space, save wiring, save time

- Built-in MECHATROLINK-II motion bus
- Position, speed and torque control
- High-response frequency of 1 kHz
- Real time auto-tuning
- Vibration suppression
- Separate power and control power supply
- Available motors with absolute and incremental with 17-bit encoder for greater accuracy
- Cylindrical and flat servo motors up to 3000 rpm
- Servomotors supported by SmartStep2, G-Series and G5-Series servo drives
- Peak torque 300% of continuous torque during 3 seconds or more depending on model
- IP65 and shaft oil seal available

Ratings

- 230 VAC single-phase 100 W to 1.5 kW (8.62 Nm)



System configuration



Servo drive type designation

Servo drive

R88D-GN04H-ML2

G-Series servo drive

N: Network type

Capacity

01	100 W
02	200 W
04	400 W
08	750 W
10	1.0 kW
15	1.5 kW

Model

ML2: MECHATROLINK-II communications

Source voltage

H: 230 V

Servo drive specifications

G-Series servo drive

Servo drive type		R88D-GN□	01H-ML2	02H-ML2	04H-ML2	08H-ML2	10H-ML2	15H-ML2
Applicable servomotor		R88M-G□	05030□/10030□	20030□	40030□	75030□	G1K020T□	90010T□/1K030T□/ 1K5□0T□
		R88M-GP□	10030□	20030□	40030□	-	-	-
Max. applicable motor capacity		W	100	200	400	750	1000	1500
Continuous output current		Arms	1.16	1.6	2.7	4.0	5.9	9.8
Max. output current		Arms	3.5	5.3	7.1	14.1	21.2	28.3
Input power		Main circuit	For single-phase, 200 to 240 VAC +10 to -15% (50/60 Hz)			For single-phase/ three-phase, 200 to 240 VAC +10 to -15% (50/60 Hz)		
Supply		Control circuit	For single-phase, 200 to 240 VAC +10 to -15% (50/60 Hz)					
Control method		IGBT-driven PWM method						
Feedback		Serial encoder (incremental/absolute)						
Usage/storage temperature		0 to +55 °C / -20 to 65 °C						
Usage/storage humidity		90% RH or less (non-condensing)						
Altitude		1000m or less above sea level						
Vibration/shock resistance		5.88 m/s ² / 19.6 m/s ²						
Configuration		Base mounted						
Approx. weight		Kg	0.8	1.1	1.5	1.7		
Speed control range		1:5000						
Speed variance		Load variance	During 0 to 100% load ±0.01 max. (at rated speed)					
		Voltage variance	0% at ±10% of rated voltage (at rated speed)					
		Temperature variance	0 to 50°C ±0.1% max. (at rated speed)					
Frequency characteristics		1 kHz						
Torque control accuracy (reproducibility)		±3% (at 20% to 100% of rated torque)						
Soft start time setting		0 to 10 s (acceleration time and deceleration time can be set)						
MECHATROLINK Communication		MECHATROLINK-II commands (for sequence, motion, data setting/reference, monitor, adjustment and other commands)						
Sequence input signal		Emergency stop, 3 external latch signals, forward/reverse torque limit, forward/reverse run prohibit, origin proximity, 3 general-purpose inputs						
Sequence output signal		It is possible to output three types of signals: positioning completed, speed coincidence, rotation speed detection, servo ready, current limit, speed limit, brake release and warning signal						

Servo drive type		R88D-GN□	01H-ML2	02H-ML2	04H-ML2	08H-ML2	10H-ML2	15H-ML2
Applicable servomotor		R88M-G□	05030□/10030□	20030□	40030□	75030□	G1K020T□	90010T□/1K030T□/ 1K5□0T□
		R88M-GP□	10030□	20030□	40030□	-	-	-
Communications	RS-232 communications	Interface	Personal computer					
		Transmission rate	From 2400 to 57600 bps					
		Functions	Parameter setting, status display, alarm display (monitor, clear, history), servo drive data tracing function, test run/autotuning operations, real time trace, absolute encoder setting, default values function					
	MECHATROLINK communications	Communications protocol	MECHATROLINK-II					
		Transmission rate	10 Mbps					
		Data length	32 bytes					
		Functions	Parameter setting, status display, alarm display (monitor, clear, history), default values function					
	Integrated functions	Automatic load inertia detection	Horizontal and vertical axis mode. One parameter rigidity setting.					
		Dynamic brake (DB)	Operates when main power OFF, servo alarm, overtravel or servo OFF					
		Regenerative processing	Built-in regeneration resistor in models from 750 W to 1.5 kW. External regeneration resistor optionally.					
Overtravel (OT) prevention function		Dynamic brake, disables torque or emergency stop torque during POT and NOT operation						
Emergency stop (STOP)		Emergency stop input						
Encoder divider function		Optional division pulses possible						
Electronic gearing		0,01<Numerator/Denominator<100						
Internal speed setting function		8 internal speeds						
Protective functions		Overvoltage, undervoltage, overcurrent, overload, regeneration overload, servo drive overheat						
Analog monitor Output		The actual servomotor speed, command speed, torque and number of accumulated pulses can be measured using an oscilloscope or other device.						
Panel operator		Display functions	A 2-digit 7-segment LED display shows the servo drive status, alarm codes, parameters, etc. MECHATROLINK-II communications status LED indicator (COM)					
		Switches	Rotary switch for setting the MECHATROLINK-II node address					

Servo drive part names



Dimensions

Servo drives

R88D-GN01H-ML2 / GN02H-ML2 (200 V, 100 to 200 W)



R88D-GN04H-ML2 (200 V, 400 W)



R88D-GN08H-ML2 (200 V, 750 W)



R88D-GN10H-ML2 / GN15H-ML2 (200 V, 1 kW to 1,5 kW)



Servo motors type designation

Servo motor

R88M-GP10030H-BOS2

G-Series Servomotor

Motor Type

- Blank: Cylinder type
- P: Flat type

Capacity

050	50 W
100	100 W
200	200 W
400	400 W
750	750 W
900	900 W
1K0	1 kW
1K5	1.5 kW

Rated Speed (r/min)

10	1000
20	2000
30	3000

Shaft end specifications

Blank	Straigh shaft, no key
S2	Straigh, key, tapped

Oil seal specifications

Blank	No oil seal
O	Oil seal

Brake specifications

Blank	No brake
B	Brake

Voltage and encoder specifications

- H: 230 V with incremental encoder
- T: 230 V with absolute encoder

Servo motor specifications

Cylindrical servo motors 3000/2000/1000 r/min

Ratings and specifications

Applied voltage		230 V									
Servo motor model R88M-□		G05030	G10030	G20030	G40030	G75030	G1K030T	G1K530T	G1K020T	G1K520T	G90010T
Rated output	W	50	100	200	400	750	1000	1500	1000	1500	900
Rated torque	N·m	0.16	0.32	0.64	1.3	2.4	3.18	4.77	4.8	7.15	8.62
Instantaneous peak torque	N·m	0.45	0.90	1.78	3.67	7.05	9.1	12.8	13.5	19.6	18.4
Rated current	A (rms)	1.1		1.6	2.6	4	7.2	9.4	5.6	9.4	7.6
Instantaneous max. current	A (rms)	3.4		4.9	7.9	12.1	21.4	28.5	17.1	28.5	17.1
Rated speed	min ⁻¹	3000							2000		1000
Max. speed	min ⁻¹	5000				4500	5000		3000		2000
Torque constant	N·m/A (rms)	0.14	0.19	0.41	0.51	0.64	0.44	0.51	0.88	0.76	1.13
Rotor moment of inertia (JM)	kg·m ² ×10 ⁻⁴	0.025	0.051	0.14	0.26	0.87	1.69	2.59	6.17	11.2	
Allowable load moment of inertia (JL)	Multiple of (JM)	30				20	15		10		
Rated power rate	kW/s	10.4	20.1	30.3	62.5	66	60	88	37.3	45.8	66.3
Applicable Encoder		Incremental encoder (10000 pulses)					-				
		Incremental /Absolute encoder(17 bits)									
Allowable radial load	N	68		245		392		490		686	
Allowable thrust load	N	58		98		147		196			
Approx. mass	Kg (without brake)	0.3	0.5	0.8	1.2	2.3	4.5	5.1	6.8	8.5	
	Kg (with brake)	0.5	0.7	1.3	1.7	3.1	5.1	6.5	8.7	10.1	10
Brake specifications	Rated voltage	24 VDC +/-5%					24 VDC +/-10%				
	Holding brake moment of inertia J	0.002		0.018		0.075	0.25	0.33	1.35		
	Power consumption (at 20°C)	7		9		10	18	19	14	19	
	Current consumption (at 20°C)	0.3		0.36		0.42	0.74	0.81	0.59	0.79	
	Static friction torque	0.29		1.27		2.45	4.9	7.8	4.9	13.7	
	Rise time for holding torque	35		50		70	50		80	100	
Release time	20		15		20	15		70	50		
Basic specifications	Rating	Continuous									
	Insulation grade	Type B					Type F				
	Ambient operating/ storage temperature	0 to +40°C/ -20 to 65°C					0 to +40°C/ -20 to 80°C				
	Ambient operating/ storage humidity	85% RH max. (non-condensing)									
	Vibration class	V-15									
	Insulation resistance	20 MΩ min. at 500 VDC between the power terminals and FG terminal									
	Enclosure	Totally-enclosed, self-cooling, IP65 (excluding shaft opening and lead wire ends)									
	Vibration resistance	Vibration acceleration 49 m/s ²					Vibration acceleration 24.5 m/s ²				
Mounting	Flange-mounted										

Torque-speed characteristics

R88M-G05030H/T (50 W)

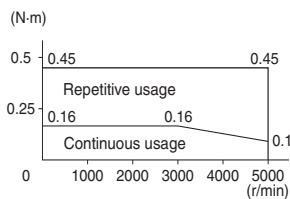

R88M-G10030H/T (100 W)



R88M-G20030H/T (200 W)



R88M-G40030H/T (400 W)



R88M-G75030H/T (750 W)

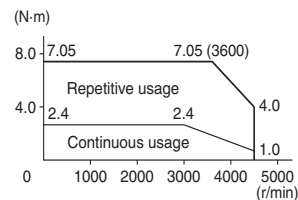

R88M-G1K030T (1 kW)



R88M-G1K530T (1.5 kW)



R88M-G1K020T (1 kW)



R88M-G1K520T (1.5 kW)

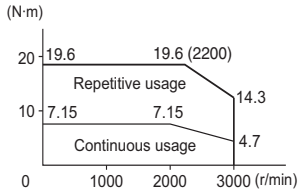

R88M-G90010T (900 W)



Flat servo motors 3000 r/min

Ratings and specifications

Applied voltage		230 V		
Servo motor model R88M-□		GP10030□	GP20030□	GP40030□
Rated output	W	100	200	400
Rated torque	N·m	0.32	0.64	1.3
Instantaneous peak torque	N·m	0.86	1.8	3.65
Rated current	A (rms)	1	1.6	2.5
Instantaneous max. current	A (rms)	3.1	4.9	7.5
Rated speed	min ⁻¹	3000		
Max. speed	min ⁻¹	5000		
Torque constant	N·m/A (rms)	0.34	0.42	0.54
Rotor moment of inertia (JM)	kg·m ² ×10 ⁻⁴	0.1	0.35	0.64
Allowable load moment of inertia (JL)	Multiple of (JM)	20		
Rated power rate	kW/s	10.2	11.5	25.5
Applicable encoder		Incremental (10000 pulses)		
		Incremental /Absolute encoder(17 bits)		
Allowable radial load	N	68	245	
Allowable thrust load	N	58	98	
Approx. mass	Kg (without brake)	0.7	1.3	1.8
	Kg (with brake)	0.9	2	2.5
Brake specifications	Rated voltage	24VDC +/-10%		
	Holding brake moment of inertia J	kg·m ² ×10 ⁻⁴	0.03	0.09
	Power consumption (at 20°C)	W	7	10
	Current consumption (at 20°C)	A	0.29	0.41
	Static friction torque	N·m (minimum)	0.29	1.27
	Rise time for holding torque	ms (max.)	50	60
	Release time	ms (max)	15	
Basic specifications	Rating	Continuous		
	Insulation grade	Type B		
	Ambient operating/ storage temperature	0 to +40 °C/ -20 to 80°C		
	Ambient operating/ storage humidity	85% RH max. (non-condensing)		
	Vibration class	V-15		
	Insulation resistance	20 MΩ min. at 500 VDC between the power terminals and FG terminal		
	Enclosure	Totally-enclosed, self-cooling, IP65 (excluding shaft opening and lead wire ends)		
	Vibration resistance	Vibration acceleration 49 m/s ²		
Mounting	Flange-mounted			

Torque-speed characteristics

R88M-GP10030H/T (100 W) R88M-GP20030H/T (200 W) R88M-GP40030H/T (400 W)



Dimensions

Servo motors

Cylindrical type 3000 r/min (230 V, 50-100 W)

Dimensions (mm)	Without brake	With brake	LN	Flange surface		Shaft end		Aprox. Mass (Kg)	
	LL	LL		D	S	B	Without brake	With brake	
R88M-G05030□□S2	72	102	26.5	30 ^{h7}	8 ^{h6}	3 ^{h9}	0.3	0.5	
R88M-G10030□□S2	92	122	46.5				0.5	0.7	



Cylindrical type 3000 r/min (230 V, 200-750 W)

Dimensions (mm)	Without brake	With brake	LR	KL1	Flange surface					Shaft end					Aprox. Mass (Kg)		
	LL	LL			D1	D2	C	G	Z	S	QK	B	H	T1	Tap x depth	Without brake	With brake
R88M-G20030□□S2	79.5	116	30	43	70	50 ^{h7}	60	6.5	4.5	11 ^{h6}	18	4 ^{h9}	4	2.5	M4x8L	0.8	1.3
R88M-G40030□□S2	99	135.5								14 ^{h6}	22.5	5 ^{h9}	5	3	M5x10L	1.2	1.7
R88M-G75030□□S2	112.2	149.2	35	53	90	70 ^{h7}	80	8	6	19 ^{h6}	22	6 ^{h9}	6	3.5		2.3	3.1



Cylindrical type 3000, 2000 and 1000 r/min (230 V, 900 kW - 1.5 kW)

Dimensions (mm)	Without brake	With brake	LR	KL1	Flange surface								Shaft end					Aprox. Mass (Kg)		
					D1	D2	D3	C	G	F	Z	S	QK	B	H	T1	Tap x depth	Without brake	With brake	
R88M-G1K030T-□S2	175	200	55	98	100	80 ^{h7}	120	90	7	3	6.6	19 ^{h6}	42	6 ^{h9}	6	3.5	M5x12L	4.5	5.1	
R88M-G1K530T-□S2	180	205		103	115	95 ^{h7}	135	100	10		9								5.1	6.5
R88M-G1K020T-□S2	150	175		118	145	110 ^{h7}	165	130	12	6		22 ^{h6}	41	8 ^{h9}	7	4			6.8	8.7
R88M-G1K520T-□S2	175	200																	8.5	10.1
R88M-G90010T-□S2	175	200	70																10	



Flat type 3000 r/min (230 V, 100 W - 400 W)

Dimensions (mm)	Without brake	With brake	LR	KL1	Flange surface							Shaft end					Aprox. Mass (Kg)			
					D1	D2	C	F	G	Z	S	QK	B	H	T1	Tap x depth	Without brake	With brake		
R88M-GP10030H-□S2	60.5	84.5	25	43	70	50 ^{h7}	60	3	7	4.5	8 ^{h6}	12.5	3 ^{h9}	3	1.8	M3x6L	0.7	0.9		
R88M-GP10030T-□S2	87.5	111.5																		
R88M-GP20030H-□S2	67.5	100	30	53	90	70 ^{h7}	80	5	8	5.5	11 ^{h6}	18	4 ^{h9}	4	2.5	M4x8L	1.3	2		
R88M-GP20030T-□S2	94.5	127																		
R88M-GP40030H-□S2	82.5	115											14 ^{h6}	22.5	5 ^{h9}	5	3.0	M5x10L	1.8	2.5
R88M-GP40030T-□S2	109.5	142																		



Installation

Single-phase, 230 VAC



- *1 Connect when using an absolute encoder. If a backup battery is connected, an encoder cable with a battery is not required.
- *2 Connect B2-B3 for the models with a built-in regeneration resistor (models from 750 W).
- *3 If the amount of regeneration is large, connect an external regeneration resistor to B1-B2. For the models from 750 W, disconnect B2-B3.

Ordering information



Note: The symbols ①②③④⑤... show the recommended sequence to select the components in a G-Series servo system

Servo drives

Symbol	Specifications		Servo drive model	① Compatible rotary servo motors		
				Cylindric type	Flat type	
②	1 phase 200 VAC	100 W	R88D-GN01H-ML2	R88M-G05030□	R88M-GP10030□	
			R88M-G10030□			
			200 W	R88D-GN02H-ML2	R88M-G20030□	R88M-GP20030□
			400 W	R88D-GN04H-ML2	R88M-G40030□	R88M-GP40030□
			750 W	R88D-GN08H-ML2	R88M-G75030□	-
			1.0 kW	R88D-GN10H-ML2	R88M-G1K020T□	-
			1.5 kW	R88D-GN15H-ML2	R88M-G90010T□	-
			R88M-G1K030T□	-		
			R88M-G1K520T□	-		
			R88M-G1K530T□	-		

Control cables (for CN1)

Symbol	Name	Connect to	Model	
⑥	I/O connector kit	Servo drive I/O signals	R88A-CNU01C	
⑦	Terminal block cable		1 m	XW2Z-100J-B33
			2 m	XW2Z-200J-B33
⑧	Terminal block	-	XW2B-20G4	
			XW2B-20G5	
			XW2D-20G6	

Computer cable (for CN3)

Symbol	Name	Model
⑨	Computer cable RS232	R88A-CCG002P2

MECHATROLINK-II Motion controllers

Symbol	Name	Model
⑩	Trajexia stand-alone motion controller	TJ1-MC04 (4 axes)
		TJ1-MC16 (16 axes)
	Trajexia-PLC motion controller	CJ1W-MCH72
	Position Controller Unit for CJ1 PLC	CJ1W-NCF71 (16 axes)
		CJ1W-NC471 (4 axes)
		CJ1W-NC271 (2 axes)
	Position Controller Unit for CS1 PLC	CS1W-NCF71 (16 axes)
		CS1W-NC471 (4 axes)
		CS1W-NC271 (2 axes)

Computer software

Specifications	Model
Configuration and monitoring software tool for servo drives and inverters. (CX-drive version 1.70 or higher)	CX-drive
Complete OMRON software package including CX-drive. (CX-One version 3.10 or higher)	CX-One

MECHATROLINK-II cables (for CN6)

Symbol	Specifications	Length	Model
⑪	MECHATROLINK-II Terminator resistor	-	JEPMC-W6022-E
		MECHATROLINK-II cables	0.5 m
		1 m	JEPMC-W6003-01-E
		3 m	JEPMC-W6003-03-E
		5 m	JEPMC-W6003-05-E
		10 m	JEPMC-W6003-10-E
		20 m	JEPMC-W6003-20-E
		30 m	JEPMC-W6003-30-E

Footprint filters

Symbol	Applicable servodrive	Filter model	Rated current	Leakage current	Rated voltage
⑫	R88D-GN01H□	R88A-FIK102-RE	2.4 A	3.5 mA	250 VAC single-phase
	R88D-GN02H□				
	R88D-GN04H□	R88A-FIK104-RE	4.1 A	3.5 mA	
	R88D-GN08H□				
	R88D-GN10H□	R88A-FIK114-RE	14.2 A	3.5 mA	
	R88D-GN15H□				

External regenerative resistor

Symbol	Regenerative resistor unit model	Specifications
⑬	R88A-RR08050S	50 Ω, 80 W
	R88A-RR080100S	100 Ω, 80 W
	R88A-RR22047S	47 Ω, 220 W
	R88A-RR50020S	20 Ω, 500 W

Cylindrical servo motors 3000/2000/1000 r/min (50 - 1.5 kW)

Symbol	Specifications						Servo motor model	Compatible servo drives (2)	
	Voltage	Encoder and design	Speed	Design	Rated torque	Capacity			
 (50-750 W)  (900-1500 W)	230 V	Incremental encoder (10000 pulses) Straight shaft with key & tap	3000 min ⁻¹	Without brake	0.16 Nm	50 W	R88M-G05030H-S2	R88D-GN01H-ML2	
					0.32 Nm	100 W	R88M-G10030H-S2	R88D-GN01H-ML2	
					0.64 Nm	200 W	R88M-G20030H-S2	R88D-GN02H-ML2	
					1.3 Nm	400 W	R88M-G40030H-S2	R88D-GN04H-ML2	
					2.4 Nm	750 W	R88M-G75030H-S2	R88D-GN08H-ML2	
					2.4 Nm	750 W	R88M-G75030H-BS2	R88D-GN08H-ML2	
				With brake	0.16 Nm	50 W	R88M-G05030H-BS2	R88D-GN01H-ML2	
					0.32 Nm	100 W	R88M-G10030H-BS2	R88D-GN01H-ML2	
					0.64 Nm	200 W	R88M-G20030H-BS2	R88D-GN02H-ML2	
					1.3 Nm	400 W	R88M-G40030H-BS2	R88D-GN04H-ML2	
					2.4 Nm	750 W	R88M-G75030H-BS2	R88D-GN08H-ML2	
					2.4 Nm	750 W	R88M-G75030H-BS2	R88D-GN08H-ML2	
		Absolute/ incremental encoder (17 bits) Straight shaft with key & tap	Without brake	0.16 Nm	50 W	R88M-G05030T-S2	R88D-GN01H-ML2		
				0.32 Nm	100 W	R88M-G10030T-S2	R88D-GN01H-ML2		
				0.64 Nm	200 W	R88M-G20030T-S2	R88D-GN02H-ML2		
				1.3 Nm	400 W	R88M-G40030T-S2	R88D-GN04H-ML2		
				2.4 Nm	750 W	R88M-G75030T-S2	R88D-GN08H-ML2		
				3.18 Nm	1 kW	R88M-G1K030T-S2	R88D-GN15H-ML2		
			With brake	4.77 Nm	1.5 kW	R88M-G1K530T-S2	R88D-GN15H-ML2		
				0.16 Nm	50 W	R88M-G05030T-BS2	R88D-GN01H-ML2		
				0.32 Nm	100 W	R88M-G10030T-BS2	R88D-GN01H-ML2		
				0.64 Nm	200 W	R88M-G20030T-BS2	R88D-GN02H-ML2		
				1.3 Nm	400 W	R88M-G40030T-BS2	R88D-GN04H-ML2		
				2.4 Nm	750 W	R88M-G75030T-BS2	R88D-GN08H-ML2		
2000 min ⁻¹	Without brake	3000 min ⁻¹	4.8 Nm	1 kW	R88M-G1K020T-S2	R88D-GN10H-ML2			
			7.15 Nm	1.5 kW	R88M-G1K520T-S2	R88D-GN15H-ML2			
			With brake	4.8 Nm	1 kW	R88M-G1K020T-BS2	R88D-GN10H-ML2		
				7.15 Nm	1.5 kW	R88M-G1K520T-BS2	R88D-GN15H-ML2		
				1000 min ⁻¹	Without brake	8.62 Nm	900 W	R88M-G90010T-S2	R88D-GN15H-ML2
						8.62 Nm	900 W	R88M-G90010T-BS2	R88D-GN15H-ML2

Flat type servo motors 3000 r/min (100 - 400 W)

Symbol	Specifications				Servo motor model	Compatible servo drives (2)		
	Voltage	Encoder and design	Rated torque	Capacity				
	230 V	Incremental encoder (10000 pulses) Straight shaft with key & tap	3000 r/min	Without brake	0.32 Nm	100 W	R88M-GP10030H-S2	R88D-GN01H-ML2
					0.64 Nm	200 W	R88M-GP20030H-S2	R88D-GN02H-ML2
					1.3 Nm	400 W	R88M-GP40030H-S2	R88D-GN04H-ML2
				With brake	0.32 Nm	100 W	R88M-GP10030H-BS2	R88D-GN01H-ML2
					0.64 Nm	200 W	R88M-GP20030H-BS2	R88D-GN02H-ML2
					1.3 Nm	400 W	R88M-GP40030H-BS2	R88D-GN04H-ML2
		Absolute/ incremental encoder (17 bits) Straight shaft with key & tap	Without brake	0.32 Nm	100 W	R88M-GP10030T-S2	R88D-GN01H-ML2	
				0.64 Nm	200 W	R88M-GP20030T-S2	R88D-GN02H-ML2	
				1.3 Nm	400 W	R88M-GP40030T-S2	R88D-GN04H-ML2	
			With brake	0.32 Nm	100 W	R88M-GP10030T-BS2	R88D-GN01H-ML2	
				0.64 Nm	200 W	R88M-GP20030T-BS2	R88D-GN02H-ML2	
				1.3 Nm	400 W	R88M-GP40030T-BS2	R88D-GN04H-ML2	

Encoder Cables

Symbol	Specifications	Model	Appearance
③	Encoder cable for absolute encoder (50-750 W) R88M-G(050/100/200/400/750)30T-□ R88M-GP(100/200/400)30T-□	1.5 m	R88A-CRGA001-5CR-E
		3 m	R88A-CRGA003CR-E
		5 m	R88A-CRGA005CR-E
		10 m	R88A-CRGA010CR-E
		15 m	R88A-CRGA015CR-E
		20 m	R88A-CRGA020CR-E
	Encoder cable for Incremental encoder (50-750 W) R88M-G(050/100/200/400/750)30H-□ R88M-GP(100/200/400)30H-□	1.5 m	R88A-CRGA001-5CR-E
		3 m	R88A-CRGA003CR-E
		5 m	R88A-CRGA005CR-E
		10 m	R88A-CRGA010CR-E
		15 m	R88A-CRGA015CR-E
		20 m	R88A-CRGA020CR-E
	Encoder cable for Absolute encoder (900-1500 W) R88M-G(1K0/1K5)30T-□ R88M-G(1K0/1K5)20T-□ R88M-G90010T-□	1.5 m	R88A-CRGA001-5NR-E
		3 m	R88A-CRGA003NR-E
		5 m	R88A-CRGA005NR-E
		10 m	R88A-CRGA010NR-E
		15 m	R88A-CRGA015NR-E
		20 m	R88A-CRGA020NR-E

Absolute Encoder Battery cable

Symbol	Specifications	Model	Appearance
③	Absolute Encoder battery cable Battery not included	0.3 m	R88A-CRGD0R3C
		One R88A-BAT01G Battery included	R88A-CRGD0R3C-BS
	Absolute Encoder backup battery 2,000 mA.h 3.6V	-	R88A-BAT01G

Note: The absolute encoder battery cable is only an extension and must be used with an absolute encoder cable.

Power cables

Symbol	Specifications	Model	Appearance	
④	For servomotors from 50 to 750W R88M-G(050/100/200/400/750)30□ R88M-GP(100/200/400)30□ For servomotors with brake, a separate cable (R88A-CAGA□BR-E) is needed	1.5 m	R88A-CAGA001-5SR-E	
		3 m	R88A-CAGA003SR-E	
		5 m	R88A-CAGA005SR-E	
		10 m	R88A-CAGA010SR-E	
		15 m	R88A-CAGA015SR-E	
		20 m	R88A-CAGA020SR-E	
	For servomotors from 900 to 1.5 kW without brake R88M-G(1K0/1K5)30T-S2 R88M-G(1K0/1K5)20T-S2 R88M-G90010T-S2	1.5 m	R88A-CAGB001-5SR-E	
		3 m	R88A-CAGB003SR-E	
		5 m	R88A-CAGB005SR-E	
		10 m	R88A-CAGB010SR-E	
		15 m	R88A-CAGB015SR-E	
		20 m	R88A-CAGB020SR-E	
	For servomotors from 900 to 1.5 kW with brake R88M-G(1K0/1K5)30T-BS2 R88M-G(1K0/1K5)20T-BS2 R88M-G90010T-BS2	1.5 m	R88A-CAGB001-5BR-E	
		3 m	R88A-CAGB003BR-E	
		5 m	R88A-CAGB005BR-E	
		10 m	R88A-CAGB010BR-E	
		15 m	R88A-CAGB015BR-E	
		20 m	R88A-CAGB020BR-E	

Brake cable (for 50-750W servomotors)

Symbol	Specifications	Model	Appearance	
⑤	Brake cable only. For servomotors from 50 to 750W with brake R88M-G(050/100/200/400/750)30□-BS2, R88M-GP(100/200/400)30□-BS2	1.5 m	R88A-CAGA001-5BR-E	
		3 m	R88A-CAGA003BR-E	
		5 m	R88A-CAGA005BR-E	
		10 m	R88A-CAGA010BR-E	
		15 m	R88A-CAGA015BR-E	
		20 m	R88A-CAGA020BR-E	

Connectors for power, encoder and brake cables

Specifications	Applicable Servomotor	Model	
Connectors for power cables	Motor side	R88M-G(050/100/200/400/750)30□, R88M-GP(100/200/400)30□	R88A-CNG01A
	Motor side	R88M-G(1K0/1K5)30□-S2, R88M-G(1K0/1K5)20□-S2, R88M-G90010□-S2 (without brake)	MS3108E20-4S
	Motor side	R88M-G(1K0/1K5)30□-BS2, R88M-G(1K0/1K5)20□-BS2, R88M-G90010□-BS2 (with brake)	MS3108E20-18S
Connectors for encoder cables	Drive side (CN2)	-	R88A-CNW01R
	Motor side	R88M-G(050/100/200/400/750)30T-□, R88M-GP(100/200/400)30T-□ (Absolute encoder)	R88A-CNG01R
	Motor side	R88M-G(050/100/200/400/750)30H-□, R88M-GP(100/200/400)30H-□ (Incremental encoder)	R88A-CNG02R
	Motor side	R88M-G(1K0/1K5)30T-□, R88M-G(1K0/1K5)20T-□, R88M-G90010T-□	MS3108E20-29S
Connector for brake cable	Motor side	R88M-G(050/100/200/400/750)30□-BS2, R88M-GP(100/200/400)30□-BS2	R88A-CNG01B

ALL DIMENSIONS SHOWN ARE IN MILLIMETERS.
To convert millimeters into inches, multiply by 0.03937. To convert grams into ounces, multiply by 0.03527.

In the interest of product improvement, specifications are subject to change without notice.

OMRON EUROPE B.V. Wegalaan 67-69, NL-2132 JD, Hoofddorp, The Netherlands. Tel: +31 (0) 23 568 13 00 Fax: +31 (0) 23 568 13 88 www.industrial.omron.eu

Austria

Tel: +43 (0) 2236 377 800
www.industrial.omron.at

Belgium

Tel: +32 (0) 2 466 24 80
www.industrial.omron.be

Czech Republic

Tel: +420 234 602 602
www.industrial.omron.cz

Denmark

Tel: +45 43 44 00 11
www.industrial.omron.dk

Finland

Tel: +358 (0) 207 464 200
www.industrial.omron.fi

France

Tel: +33 (0) 1 56 63 70 00
www.industrial.omron.fr

Germany

Tel: +49 (0) 2173 680 00
www.industrial.omron.de

Hungary

Tel: +36 1 399 30 50
www.industrial.omron.hu

Italy

Tel: +39 02 326 81
www.industrial.omron.it

Netherlands

Tel: +31 (0) 23 568 11 00
www.industrial.omron.nl

Norway

Tel: +47 (0) 22 65 75 00
www.industrial.omron.no

Poland

Tel: +48 (0) 22 645 78 60
www.industrial.omron.pl

Portugal

Tel: +351 21 942 94 00
www.industrial.omron.pt

Russia

Tel: +7 495 648 94 50
www.industrial.omron.ru

South-Africa

Tel: +27 (0)11 579 2600
www.industrial.omron.co.za

Spain

Tel: +34 913 777 900
www.industrial.omron.es

Sweden

Tel: +46 (0) 8 632 35 00
www.industrial.omron.se

Switzerland

Tel: +41 (0) 41 748 13 13
www.industrial.omron.ch

Turkey

Tel: +90 216 474 00 40
www.industrial.omron.com.tr

United Kingdom

Tel: +44 (0) 870 752 08 61
www.industrial.omron.co.uk

More Omron representatives
www.industrial.omron.eu

Automation Systems

- Programmable logic controllers (PLC) • Human machine interfaces (HMI) • Remote I/O
- Industrial PC's • Software

Motion & Drives

- Motion controllers • Servo systems • Inverters

Control Components

- Temperature controllers • Power supplies • Timers • Counters • Programmable relays
- Digital panel indicators • Electromechanical relays • Monitoring products • Solid-state relays
- Limit switches • Pushbutton switches • Low voltage switch gear

Sensing & Safety

- Photoelectric sensors • Inductive sensors • Capacitive & pressure sensors
- Cable connectors • Displacement & width-measuring sensors • Vision systems
- Safety networks • Safety sensors • Safety units/relay units • Safety door/guard lock switches

Компания «Life Electronics» занимается поставками электронных компонентов импортного и отечественного производства от производителей и со складов крупных дистрибьюторов Европы, Америки и Азии.

С конца 2013 года компания активно расширяет линейку поставок компонентов по направлению коаксиальный кабель, кварцевые генераторы и конденсаторы (керамические, пленочные, электролитические), за счёт заключения дистрибьюторских договоров

Мы предлагаем:

- Конкурентоспособные цены и скидки постоянным клиентам.
- Специальные условия для постоянных клиентов.
- Подбор аналогов.
- Поставку компонентов в любых объемах, удовлетворяющих вашим потребностям.
- Приемлемые сроки поставки, возможна ускоренная поставка.
- Доставку товара в любую точку России и стран СНГ.
- Комплексную поставку.
- Работу по проектам и поставку образцов.
- Формирование склада под заказчика.
- Сертификаты соответствия на поставляемую продукцию (по желанию клиента).
- Тестирование поставляемой продукции.
- Поставку компонентов, требующих военную и космическую приемку.
- Входной контроль качества.
- Наличие сертификата ISO.

В составе нашей компании организован Конструкторский отдел, призванный помогать разработчикам, и инженерам.

Конструкторский отдел помогает осуществить:

- Регистрацию проекта у производителя компонентов.
- Техническую поддержку проекта.
- Защиту от снятия компонента с производства.
- Оценку стоимости проекта по компонентам.
- Изготовление тестовой платы монтаж и пусконаладочные работы.



Тел: +7 (812) 336 43 04 (многоканальный)

Email: org@lifeelectronics.ru