



Features

- Radial leaded devices
- Fast tripping resettable PTCs
- Binned and sorted narrow resistance ranges available
- RoHS compliant*
- Agency recognition:   

Applications

- Customer Premise Equipment (CPE)
- Central Office / Telecom Centers (CO)
- Access equipment

MF-RX/250 Series - Telecom PTC Resettable Fuses

Electrical Characteristics

| Model | Max. Operating Voltage (Vdc) | Max. Interrupt Ratings | | Hold Current | Initial Resistance | | One Hour Post-Trip Resistance |
|----------------|------------------------------|------------------------|----------|----------------|--------------------|---------------|-------------------------------|
| | | Volts (Vrms) | Amps (A) | | Amps at 23 °C | Ohms at 23 °C | |
| | | Max. | Max. | I _H | Min. | Max. | Max. |
| MF-RX012/250 | 60 | 250 | 3.0 | 0.12 | 4.0 | 8.0 | 16.0 |
| MF-RX012/250-A | 60 | 250 | 3.0 | 0.12 | 7.0 | 9.0 | 16.0 |
| MF-RX012/250-C | 60 | 250 | 3.0 | 0.12 | 5.5 | 7.5 | 14.0 |
| MF-RX012/250-F | 60 | 250 | 3.0 | 0.12 | 6.0 | 10.5 | 16.0 |
| MF-RX012/250-1 | 60 | 250 | 3.0 | 0.12 | 6.0 | 9.0 | 16.0 |
| MF-RX012/250-2 | 60 | 250 | 3.0 | 0.12 | 8.0 | 10.5 | 16.0 |
| MF-RX012/250-T | 60 | 250 | 3.0 | 0.12 | 7.0 | 12.0 | 16.0 |
| MF-RX012/250U | 60 | 250 | 3.0 | 0.12 | 6.0 | 10.0 | 16.0 |
| MF-RX014/250 | 60 | 250 | 3.0 | 0.145 | 3.0 | 6.0 | 14.0 |
| MF-RX014/250-A | 60 | 250 | 3.0 | 0.145 | 3.0 | 5.5 | 12.0 |
| MF-RX014/250-B | 60 | 250 | 3.0 | 0.145 | 4.5 | 6.0 | 14.0 |
| MF-RX014/250-T | 60 | 250 | 3.0 | 0.145 | 5.4 | 7.5 | 14.0 |
| MF-RX014/250U | 60 | 250 | 3.0 | 0.145 | 3.5 | 6.5 | 12.0 |
| MF-RX018/250 | 60 | 250 | 10.0 | 0.18 | 0.8 | 2.0 | 4.0 |
| MF-RX018/250U | 60 | 250 | 10.0 | 0.18 | 0.8 | 2.0 | 4.0 |

*"U" suffix indicates product without insulation coating.

Environmental Characteristics

| | | |
|---|--|---------------------------------|
| Operating/Storage Temperature..... | -40 °C to +85 °C | |
| Maximum Device Surface Temperature in Tripped State | 125 °C | |
| Passive Aging | +85 °C, 1000 hours..... ±15 % typical resistance change | |
| | +60°C, 1000 hours..... ±15 % typical resistance change | |
| Humidity Aging | +85 °C, 85 % R.H. 500 hours..... ±15 % typical resistance change | |
| Thermal Shock | MIL-STD-202F, Method 107G, | ±10 % typical resistance change |
| | +125 °C to -55 °C, 10 times | ±15 % typical resistance change |
| Solvent Resistance..... | MIL-STD-202, Method 215B | No change |
| Lead Solderability | ANSI/J-STD-002 | >95 % coverage |
| Flammability | IEC 695-2-2 | No Flame for 60 secs. |
| Vibration | MIL-STD-883C, Method 2007.1, Condition A | ±5 % typical resistance change |

Test Procedures And Requirements For Model MF-RX/250 Series

| Test | Test Conditions | Accept/Reject Criteria |
|-----------------------|--|---|
| Visual/Mech | Verify dimensions and materials | Per MF physical description |
| Resistance | In still air @ 23 °C..... | R _{min} ≤ R ≤ R _{max} |
| Time to Trip..... | 5 times I _{hold} , V _{max} , 23 °C | T ≤ max. time to trip (seconds) |
| Hold Current | 30 min. at I _{hold} | No trip |
| Trip Cycle Life | V _{max} , I _{max} , 100 cycles..... | No arcing or burning |
| Trip Endurance | V _{max} , 48 hours..... | No arcing or burning |

| | |
|-----------------------|-----------|
| UL File Number | E 174545S |
| CSA File Number | CA 110338 |
| TÜV File Number | R2057213 |

*RoHS Directive 2002/95/EC Jan 27, 2003 including Annex.

Specifications are subject to change without notice.

Customers should verify actual device performance in their specific applications.

Additional Features

- Ability to withstand AC power cross conditions
- Assists equipment with meeting ITU-T K.20/K.21/K.45
- Assists equipment with meeting Telcordia GR-1089-C Intrabuilding

MF-RX/250 Series - Telecom PTC Resettable Fuses

BOURNS®

Thermal Derating Chart - I_{hold} (Amps)

| Model | Ambient Operating Temperature | | | | | | | | |
|--------------|-------------------------------|--------|-------|-------|-------|-------|-------|-------|-------|
| | -40 °C | -20 °C | 0 °C | 23 °C | 40 °C | 50 °C | 60 °C | 70 °C | 85 °C |
| MF-RX012/250 | 0.186 | 0.165 | 0.143 | 0.120 | 0.099 | 0.088 | 0.077 | 0.066 | 0.050 |
| MF-RX014/250 | 0.225 | 0.199 | 0.172 | 0.145 | 0.119 | 0.106 | 0.093 | 0.080 | 0.060 |
| MF-RX018/250 | 0.269 | 0.240 | 0.211 | 0.180 | 0.153 | 0.138 | 0.123 | 0.109 | 0.087 |

I_{trip} is approximately two times I_{hold} .

Product Dimensions

| Model | A Max. | B Max. | C Nom. | D Min. | E Max. | Physical Characteristics | | |
|---------------|-----------------|-----------------|------------------------------|----------------|----------------|--------------------------|-------|----------|
| | | | | | | Lead Dia. | Style | Material |
| MF-RX012/250 | 6.5 (0.256) | 11.0 (0.433) | 5.1 ± 0.7 (0.201 ± 0.028) | 4.7 (0.185) | 4.6 (0.181) | 0.65 (0.026) | 1 | Sn/Cu |
| MF-RX012/250U | 6.0 (0.236) | 10.0 (0.394) | 5.1 ± 0.7 (0.201 ± 0.028) | 4.7 (0.185) | 3.8 (0.150) | 0.65 (0.026) | 2 | Sn/Cu |
| MF-RX014/250 | 6.5 (0.256) | 11.0 (0.433) | 5.1 ± 0.7 (0.201 ± 0.028) | 4.7 (0.185) | 4.6 (0.181) | 0.65 (0.026) | 1 | Sn/Cu |
| MF-RX014/250U | 6.0 (0.236) | 10.0 (0.394) | 5.1 ± 0.7 (0.201 ± 0.028) | 4.7 (0.185) | 3.8 (0.150) | 0.65 (0.026) | 2 | Sn/Cu |
| MF-RX018/250 | 11.0 (0.433) | 13.6 (0.535) | 5.1 ± 0.7 (0.201 ± 0.028) | 4.7 (0.185) | 4.6 (0.181) | 0.65 (0.026) | 1 | Sn/Cu |
| MF-RX018/250U | 10.4 (0.409) | 12.6 (0.496) | 5.1 ± 0.7 (0.201 ± 0.028) | 4.7 (0.185) | 3.8 (0.150) | 0.65 (0.026) | 2 | Sn/Cu |

Packaging options: BULK: 500 pcs. per bag. TAPE & REEL: 1500 pcs. per reel (available binned).

DIMENSIONS: $\frac{\text{MM}}{\text{(INCHES)}}$

Style 1

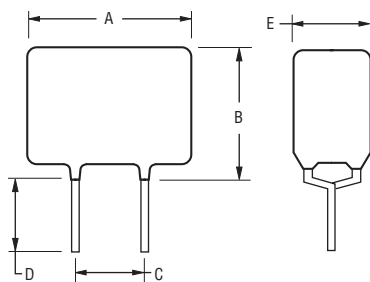

Style 2

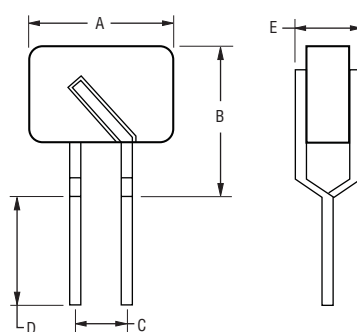

Typical Part Marking

Represents total content. Layout may vary.

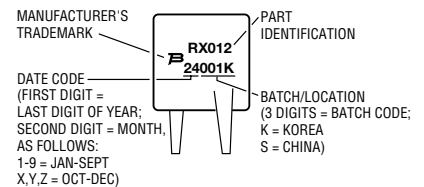

NOTE: UNCOATED PARTS HAVE NO PART MARKING. MARKING IS ON LABEL ONLY.

MF-RX/250 Series - Telecom PTC Resettable Fuses

BOURNS®

How to Order

MF - RX 012/250 U - A 5 - 2

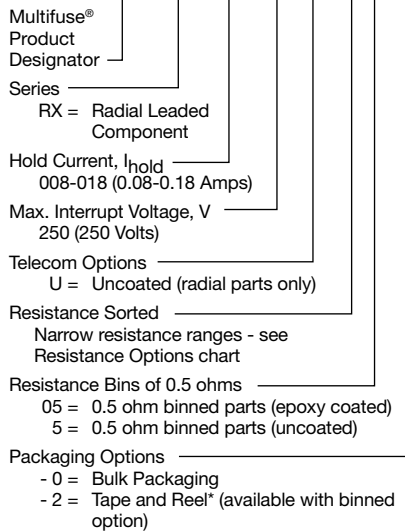

*Packaged per EIA486-B

Typical Time to Trip at 23 °C

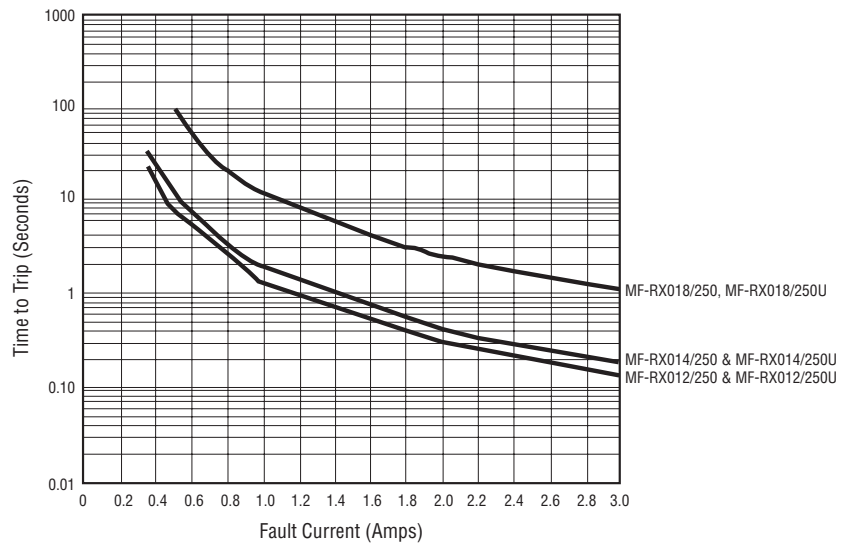

Resistance Options

| Model | Initial Resistance Values | | R1max | Bin |
|------------------|---------------------------|------|---------------|-----|
| | Ohms @ 23 ° C | | Ohms @ 23 ° C | |
| | Min. | Max. | Max. | |
| MF-RX012/250 | 4.0 | 8.0 | 16.0 | 0.5 |
| MF-RX012/250-A05 | 7.0 | 9.0 | 16.0 | 0.5 |
| MF-RX012/250-C05 | 5.5 | 7.5 | 14.0 | 0.5 |
| MF-RX012/250-F05 | 6.0 | 10.5 | 16.0 | 0.5 |
| MF-RX012/250-105 | 6.0 | 9.0 | 16.0 | 0.5 |
| MF-RX012/250-205 | 8.0 | 10.5 | 16.0 | 0.5 |
| MF-RX012/250-T05 | 7.0 | 12.0 | 16.0 | 0.5 |
| MF-RX012/250U | 6.0 | 10.0 | 16.0 | 0.5 |
| MF-RX014/250 | 3.0 | 6.0 | 14.0 | 0.5 |
| MF-RX014/250-A05 | 3.0 | 5.5 | 12.0 | 0.5 |
| MF-RX014/250-B05 | 4.5 | 6.0 | 14.0 | 0.5 |
| MF-RX014/250U | 3.5 | 6.5 | 12.0 | 0.5 |

MF-RX/250, REV. J, 05/11

Specifications are subject to change without notice.
Customers should verify actual device performance in their specific applications.

MF-R, MF-R/90, MF-R/600, MF-RX, MF-RX/72 & MF-RX/250 Series Tape and Reel Specifications

BOURNS®

Devices taped using EIA468-B/IEC286-2 standards. See table below and Figures 1 and 2 for details.

| Dimension Description | IEC Mark | EIA Mark | Dimensions | |
|--|------------|------------|------------------------|------------------------------------|
| | | | Dimensions | Tolerance |
| Carrier tape width | W | W | $\frac{18}{(.709)}$ | $\frac{-0.5/+1.0}{(-0.02/+0.039)}$ |
| Hold down tape width | W_0 | W_4 | $\frac{11}{(.433)}$ | min. |
| Hold down tape | | | No protrusion | |
| Top distance between tape edges | W_2 | W_6 | $\frac{3}{(.118)}$ | max. |
| Sprocket hole position | W_1 | W_5 | $\frac{9}{(.354)}$ | $\frac{-0.5/+0.75}{(-0.02/+0.03)}$ |
| Sprocket hole diameter | D_0 | D_0 | $\frac{4}{(.157)}$ | $\frac{\pm 0.2}{(\pm .0078)}$ |
| Abscissa to plane (straight lead) | H | H | $\frac{18.5}{(.728)}$ | $\frac{\pm 3.0}{(\pm .118)}$ |
| Abscissa to plane (kinked lead) | H_0 | H_0 | $\frac{16}{(.63)}$ | $\frac{\pm 0.5}{(\pm .02)}$ |
| Abscissa to top (straight lead) | H_1 | H_1 | $\frac{38.0}{(1.496)}$ | max. |
| Abscissa to top (kinked lead) | H_1 | H_1 | $\frac{32.2}{(1.268)}$ | max. |
| Overall width w/lead protrusion (straight lead) | | C_1 | $\frac{55.0}{(2.165)}$ | max. |
| Overall width w/lead protrusion (kinked lead) | | C_1 | $\frac{43.2}{(1.7)}$ | max. |
| Overall width w/o lead protrusion (straight lead) | | C_2 | $\frac{54.0}{(2.126)}$ | max. |
| Overall width w/o lead protrusion (kinked lead) | | C_2 | $\frac{42.5}{(1.673)}$ | max. |
| Lead protrusion | l_1 | L_1 | $\frac{1.0}{(.039)}$ | max. |
| Protrusion of cutout | L | L | $\frac{11}{(.433)}$ | max. |
| Protrusion beyond hold-down tape | l_2 | l_2 | Not specified | |
| Sprocket hole pitch | P_0 | P_0 | $\frac{12.7}{(0.5)}$ | $\frac{\pm 0.3}{(\pm .012)}$ |
| Pitch tolerance | | | 20 consecutive | $\frac{\pm 1}{(\pm .039)}$ |
| Device pitch: MF-R005–MF-R160, MF-R/90, MF-RX110/72–MF-RX185/72 | | | $\frac{12.7}{(0.5)}$ | $\frac{\pm 0.3}{(\pm .012)}$ |
| Device pitch: MF-R185–MF-R400, MF-RX110–MF-RX375 MF-R/600, MF-RX250/72–MF-RX375/72 | | | $\frac{25.4}{(1.0)}$ | $\frac{\pm 0.6}{(\pm .024)}$ |
| Tape thickness | t | t | $\frac{0.9}{(.035)}$ | max. |
| Tape thickness with splice: MF-R010–MF-R160, MF-RX110/72–MF-RX185/72 | | t_1 | $\frac{1.5}{(.059)}$ | max. |
| Tape thickness with splice: MF-R250–MF-R1100, MF-RX110–MF-RX375, MF-R/90, MF-RX250/72–MF-RX375/72 | | t_1 | $\frac{2.3}{(.091)}$ | max. |
| Splice sprocket hole alignment | | | 0 | $\frac{\pm 0.3}{(\pm .012)}$ |
| Body lateral deviation | Δ_h | Δ_h | 0 | $\frac{\pm 1.0}{(\pm .039)}$ |
| Body tape plane deviation | Δ_p | Δ_p | 0 | $\frac{\pm 1.3}{(\pm .051)}$ |

Specifications are subject to change without notice.
Customers should verify actual device performance in their specific applications.

DIMENSIONS: $\frac{\text{MM}}{\text{(INCHES)}}$

MF-R, MF-R/90, MF-R/600, MF-RX, MF-RX/72 & MF-RX/250 Series Tape and Reel Specifications

BOURNS®

| Dimension Description | IEC Mark | EIA Mark | Dimensions | | | |
|--|----------------|----------------|------------------|-----------------------------|----------------|------|
| | | | Dimensions | Tolerance | | |
| Lead spacing: MF-R, MF-R/90, MF-R/600, MF-RX, MF-RX/72 | F | F | 5.08 (0.2) | ±0.2 (±0.008) | | |
| Lead spacing: MF-RX/250 | F | F | 5.08 (0.2) | -0.5/+0.6 (-.020/+0.024) | | |
| Reel width | w | W ₂ | 56.0 (2.205) | max. | | |
| Reel diameter | d | a | 370.0 (14.57) | max. | | |
| Space between flanges less device | W ₁ | h | 4.75 (.187) | ±3.25 (±.128) | | |
| Arbor hole diameter | f | c | 26.0 (1.024) | ±12.0 (±.472) | | |
| Core diameter: MF-R, MF-RX, MF-R/90 | h | n | 80 (3.15) | max. | | |
| Core diameter: MF-RX/250, MF-R/600 | h | n | 91 (3.58) | max. | | |
| Box: MF-R, MF-RX, MF-R/90 | | | 56 (2.2) | 372 (14.6) | 372 (14.6) | max. |
| Box: MF-RX/250 | | | 67 (2.64) | 372 (14.6) | 362 (14.25) | max. |
| Box: MF-R/600 | | | 64 (2.52) | 372 (14.6) | 362 (14.25) | max. |
| Consecutive missing places: MF-R, MF-RX, MF-R/90 | | | 3 | max. | | |
| Consecutive missing places: MF-RX/250, MF-R/600 | | | none | | | |
| Empty places per reel: MF-R, MF-RX, MF-R/90 | | | | | Not specified | |
| Empty places per reel: MF-RX/250, MF-R/600 | | | | | 0.1 % | |

Taped Component Dimensions - Figure 1

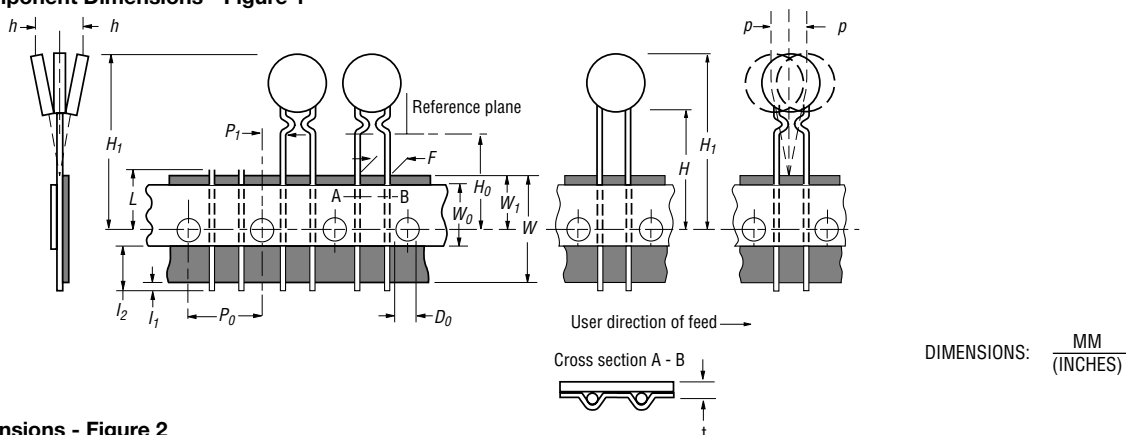

Reel Dimensions - Figure 2

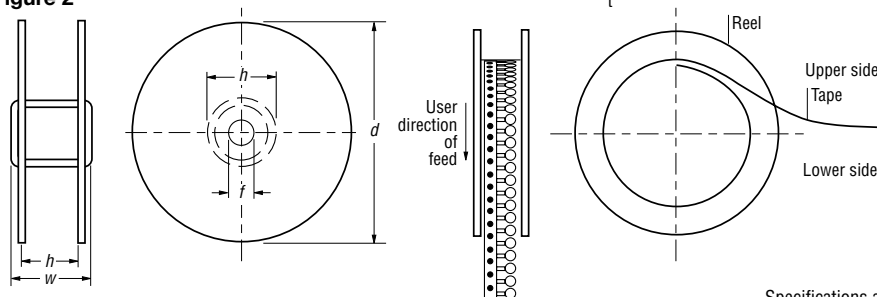

Specifications are subject to change without notice.
Customers should verify actual device performance in their specific applications.

Компания «Life Electronics» занимается поставками электронных компонентов импортного и отечественного производства от производителей и со складов крупных дистрибьюторов Европы, Америки и Азии.

С конца 2013 года компания активно расширяет линейку поставок компонентов по направлению коаксиальный кабель, кварцевые генераторы и конденсаторы (керамические, пленочные, электролитические), за счёт заключения дистрибьюторских договоров

Мы предлагаем:

- Конкурентоспособные цены и скидки постоянным клиентам.
- Специальные условия для постоянных клиентов.
- Подбор аналогов.
- Поставку компонентов в любых объемах, удовлетворяющих вашим потребностям.
- Приемлемые сроки поставки, возможна ускоренная поставка.
- Доставку товара в любую точку России и стран СНГ.
- Комплексную поставку.
- Работу по проектам и поставку образцов.
- Формирование склада под заказчика.
- Сертификаты соответствия на поставляемую продукцию (по желанию клиента).
- Тестирование поставляемой продукции.
- Поставку компонентов, требующих военную и космическую приемку.
- Входной контроль качества.
- Наличие сертификата ISO.

В составе нашей компании организован Конструкторский отдел, призванный помогать разработчикам, и инженерам.

Конструкторский отдел помогает осуществить:

- Регистрацию проекта у производителя компонентов.
- Техническую поддержку проекта.
- Защиту от снятия компонента с производства.
- Оценку стоимости проекта по компонентам.
- Изготовление тестовой платы монтаж и пусконаладочные работы.



Тел: +7 (812) 336 43 04 (многоканальный)

Email: org@lifeelectronics.ru