

PTFC210202FC

Thermally-Enhanced High Power RF LDMOS FET 28 W, 28 V, 1800 – 2200 MHz

Description

The PTFC210202FC integrates two independent 10-watt LDMOS FETs and is designed for use in cellular amplifier applications in the 2110 to 2170 MHz frequency band. Manufactured with Wolfspeed's advanced LDMOS process, this device provides excellent thermal performance and superior reliability.

PTFC210202FC
Package H-37248-4

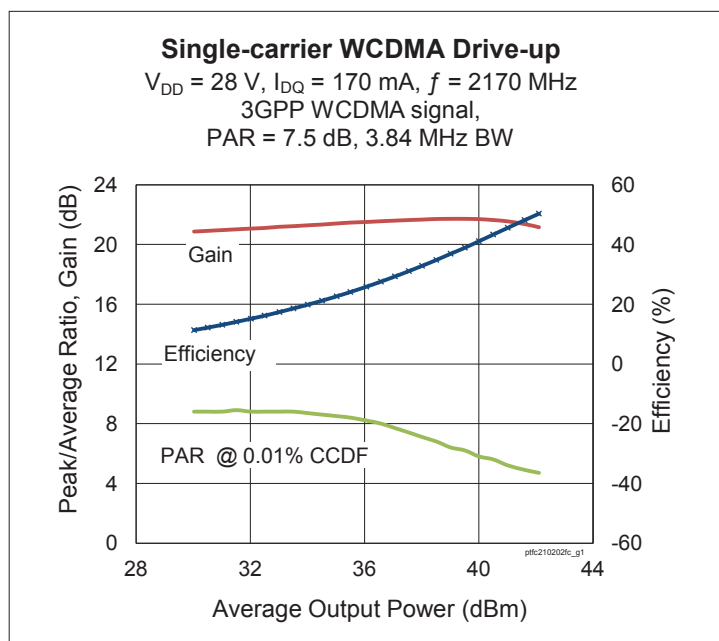

Features

- Input matched
- Typical CW performance, 2170 MHz, 28 V, combined outputs
 - Output power at $P_{1dB} = 28\text{ W}$
 - Efficiency = 62%
 - Gain = 20.9 dB
- Capable of handling 10:1 VSWR @ 28 V, 28 W (CW) output power
- Integrated ESD protection : Human Body Model, Class 1C (per JESD22-A114)
- Low thermal resistance
- Pb-free and RoHS compliant

RF Characteristics

Single-carrier WCDMA Specifications (tested in Wolfspeed test fixture)

$V_{DD} = 28\text{ V}$, $I_{DQ} = 170\text{ mA}$, $P_{OUT} = 5\text{ W avg}$, $f_1 = 2160\text{ MHz}$, $f_2 = 2170\text{ MHz}$, 3GPP signal, channel bandwidth = 3.84 MHz, peak/average = 8 dB @ 0.01% CCDF

Characteristic	Symbol	Min	Typ	Max	Unit
Linear Gain	G_{ps}	20	21	—	dB
Drain Efficiency	η_D	26.5	29	—	%
Adjacent Channel Power Ratio	ACPR	—	-31	-28	dBc

All published data at $T_{CASE} = 25^\circ\text{C}$ unless otherwise indicated

ESD: Electrostatic discharge sensitive device—observe handling precautions!

DC Characteristics (each side)

Characteristic	Conditions	Symbol	Min	Typ	Max	Unit
Drain-Source Breakdown Voltage	$V_{GS} = 0\text{ V}$, $I_{DS} = 10\text{ mA}$	$V_{(BR)DSS}$	65	—	—	V
Drain Leakage Current	$V_{DS} = 28\text{ V}$, $V_{GS} = 0\text{ V}$	I_{DSS}	—	—	0.1	μA
	$V_{DS} = 63\text{ V}$, $V_{GS} = 0\text{ V}$	I_{DSS}	—	—	1.0	μA
Gate Leakage Current	$V_{GS} = 10\text{ V}$, $V_{DS} = 0\text{ V}$	I_{GSS}	—	—	1	μA
On-State Resistance	$V_{GS} = 10\text{ V}$, $V_{DS} = 0.1\text{ V}$	$R_{DS(on)}$	—	0.05	—	Ω
Operating Gate Voltage	$V_{DS} = 28\text{ V}$, $I_{DQ} = 0.17$	V_{GS}	2.40	2.70	3.05	V

Maximum Ratings

Parameter	Symbol	Value	Unit
Drain-Source Voltage	V_{DSS}	65	V
Gate-Source Voltage	V_{GS}	-6 to +10	V
Operating Voltage	V_{DD}	0 to +32	V
Junction Temperature	T_J	225	$^{\circ}\text{C}$
Storage Temperature Range	T_{STG}	-65 to +150	$^{\circ}\text{C}$
Thermal Resistance ($T_{CASE} = 70^{\circ}\text{C}$, 25 W CW)	$R_{\theta JC}$	2.2	$^{\circ}\text{C}/\text{W}$

Ordering Information

Type and Version	Order Code	Package Description	Shipping
PTFC210202FC V1 R0	PTFC210202FC-V1-R0	H-37248-4, earless flange	Tape & Reel, 50 pcs
PTFC210202FC V1 R250	PTFC210202FC-V1-R250	H-37248-4, earless flange	Tape & Reel, 250 pcs

Typical Performance (data taken in a production test fixture)

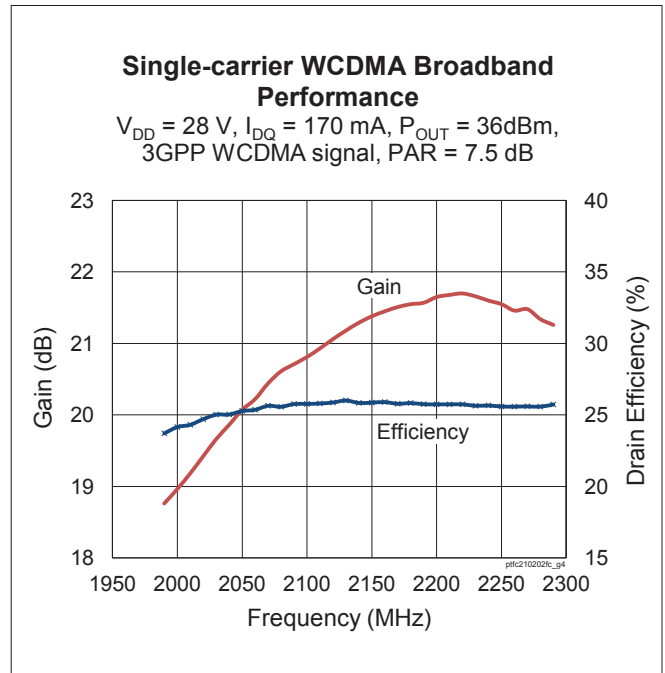
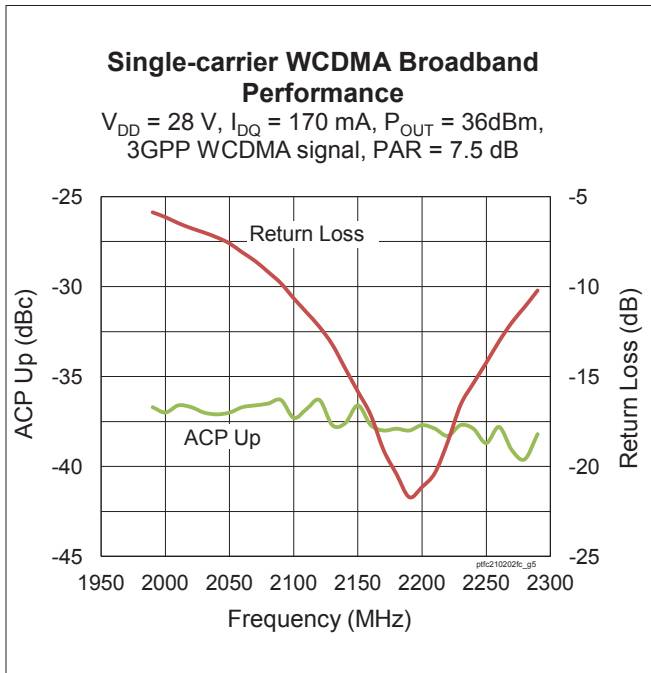
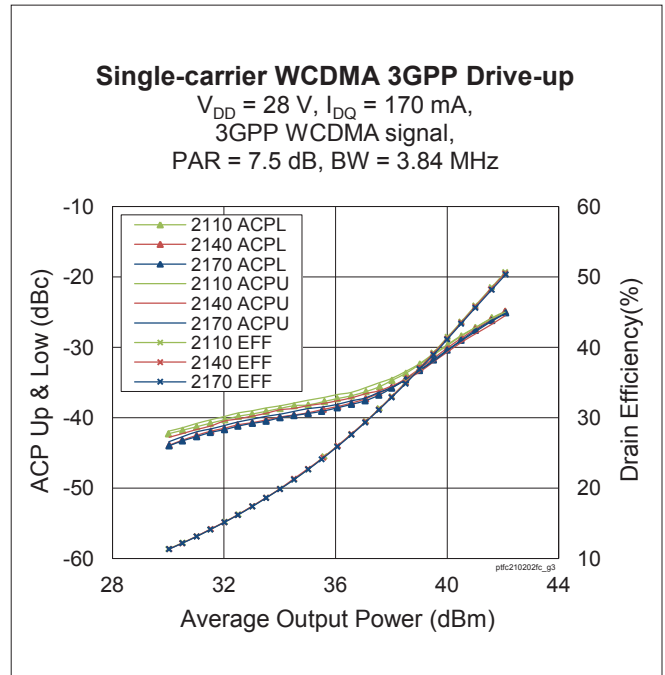
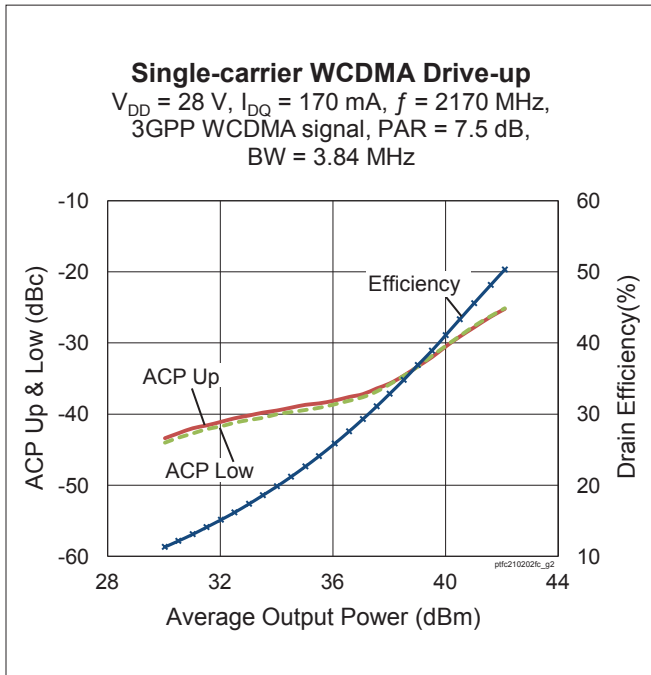



Typical Performance (cont.)

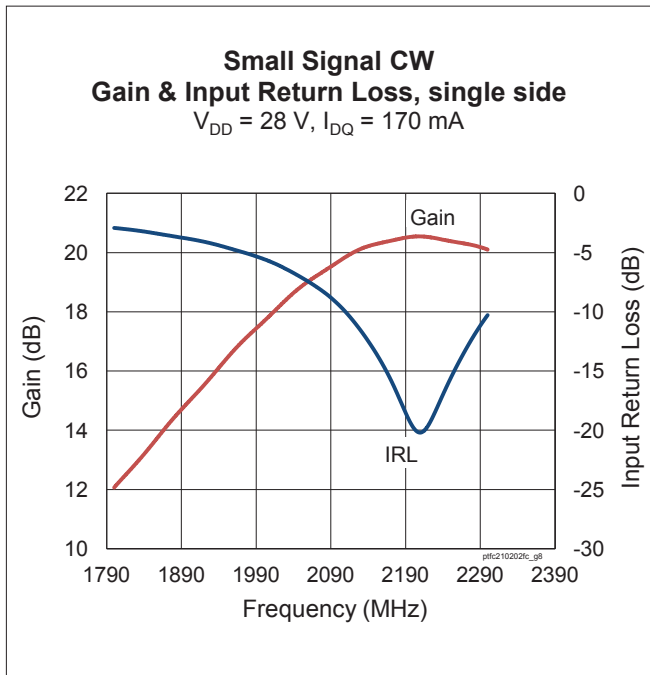
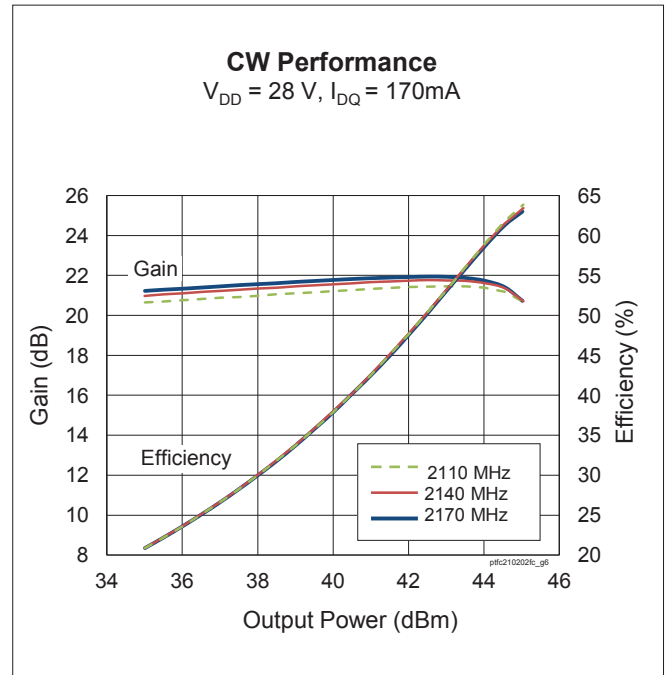
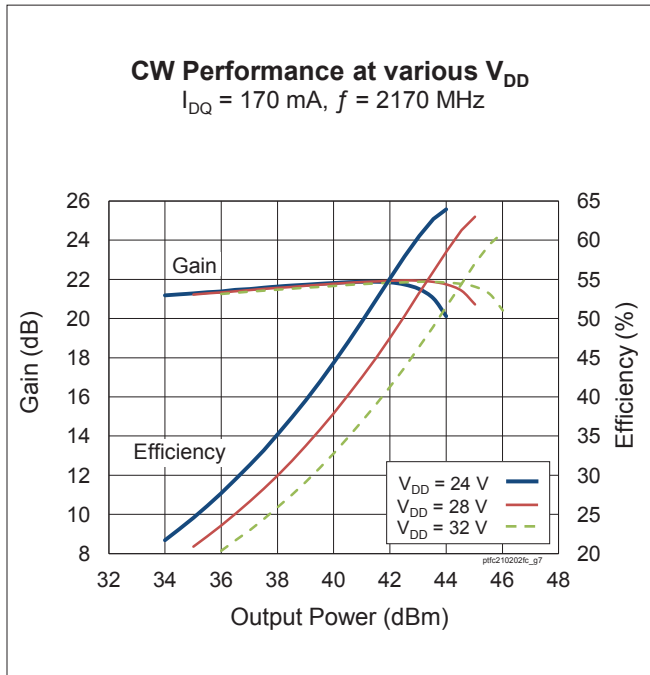

Broadband Circuit Impedance

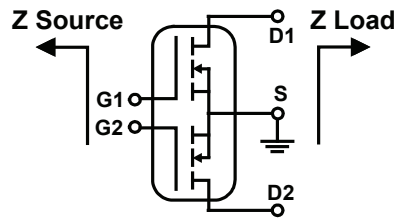

Frequency MHz	Z Source Ω		Z Load Ω	
	R	jX	R	jX
2110	4.86	-0.01	3.59	-2.65
2120	4.89	-0.01	3.63	-2.65
2130	4.92	-0.01	3.68	-2.66
2140	4.95	-0.01	3.72	-2.68
2150	4.98	-0.02	3.76	-2.69
2160	5.00	-0.02	3.81	-2.71
2170	5.03	-0.03	3.85	-2.73

Load Pull Performance

Each Side Load Pull Performance – CW signal; $V_{DD} = 28$ V, 85 mA

Freq [MHz]	Zs [Ω]	P _{1dB}									
		Max Output Power					Max PAE				
		ZI [Ω]	Gain [dB]	P _{OUT} [dBm]	P _{OUT} [W]	PAE [%]	ZI [Ω]	Gain [dB]	P _{OUT} [dBm]	P _{OUT} [W]	PAE [%]
2110	15.9 – j19.7	6.7 – j5.6	21.7	42.67	18.5	58.7	5.3 – j2.3	23.7	41.25	13.3	67.8
2140	15.7 – j18.8	7.6 – j4.9	22.3	42.16	16.4	60.5	4.9 – j2.3	24.1	40.89	12.3	67.3
2170	17.1 – j17.7	7.0 – j5.7	22.1	42.08	16.2	59.2	4.8 – j2.9	23.9	40.87	12.2	66.6



Reference Circuit

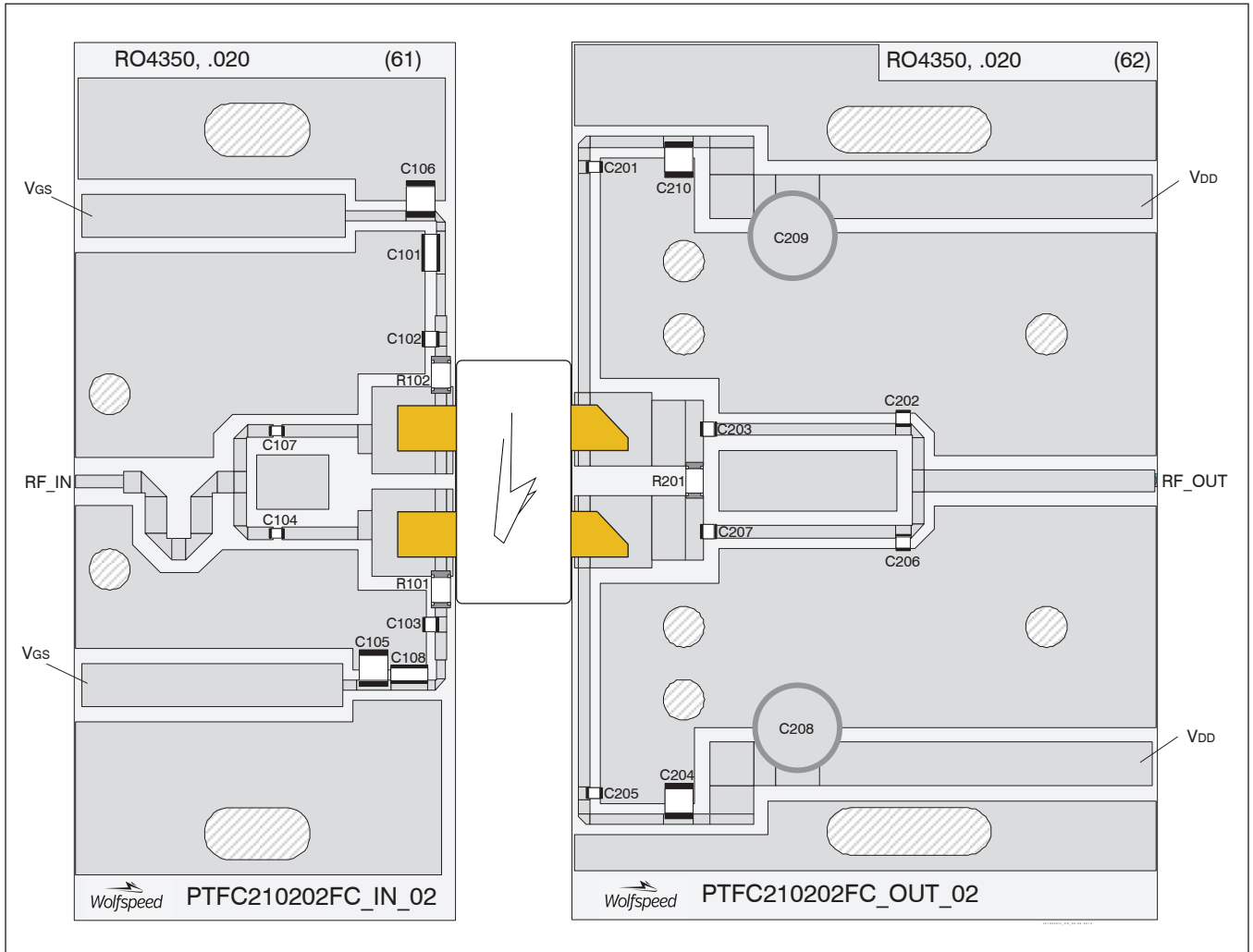

Reference circuit assembly diagram (not to scale)

Reference Circuit (cont.)**Reference Circuit Assembly**

DUT PTFC210202FC

Test Fixture Part No. LTN/PTFC210202FC

PCB Rogers 4350, 0.508 mm [0.020"] thick, 2 oz. copper, $\epsilon_r = 3.66$ Find Gerber files for this test fixture on the Wolfspeed Web site at <http://www.wolfspeed.com/RF>**Components Information**

Component	Description	Suggested Manufacturer	P/N
Input			
C101, C108	Capacitor, 10 μ F	TDK Corporation	C5750X5R1H106K230KA
C102, C103	Chip capacitor, 20 pF	ATC	ATC100A200JW150XB
C104, C107	Chip capacitor, 5.1 pF	ATC	ATC100A5R1CW250XT
C105, C106	Chip capacitor, 10 μ F	Taiyo Yuden	UMK325C7106MM-T
R101, R102	Resistor, 10 Ω	Panasonic Electronic Components	ERJ-8GEYJ100V
Output			
C201, C205	Chip capacitor, 20 pF	ATC	ATC100A200JW250XT
C202, C203, C206, C207	Chip capacitor, 1.6 pF	ATC	ATC800A1R6BT250XT
C204, C210	Chip capacitor, 10 μ F	Taiyo Yuden	UMK325C7106MM-T
C208, C09	Capacitor, 100 μ F	Panasonic Electronic Components	ECA-1HHG101
R201	Resistor, 10 Ω	ATC	CR11206T0100J

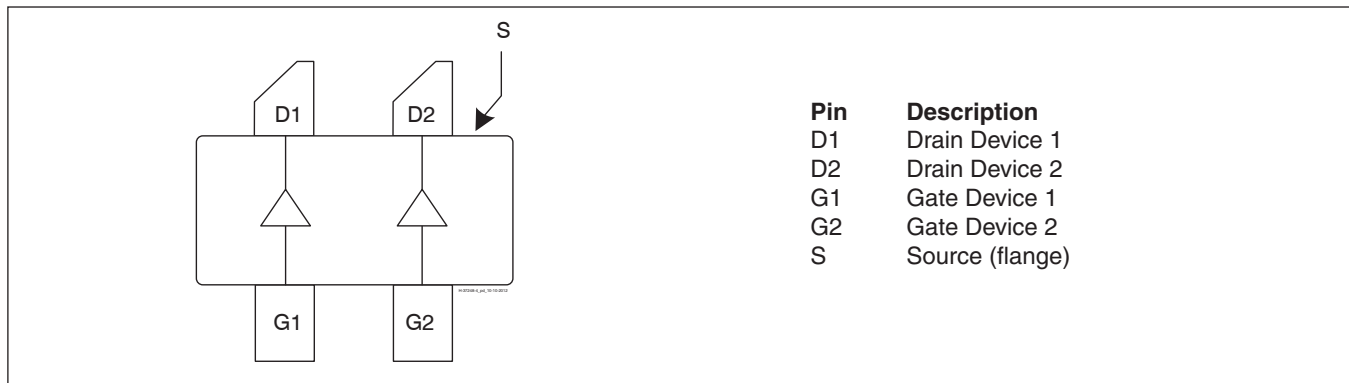
Pinout Diagram (top view)

Lead connections for PTFC210202FC

Package Outline Specifications

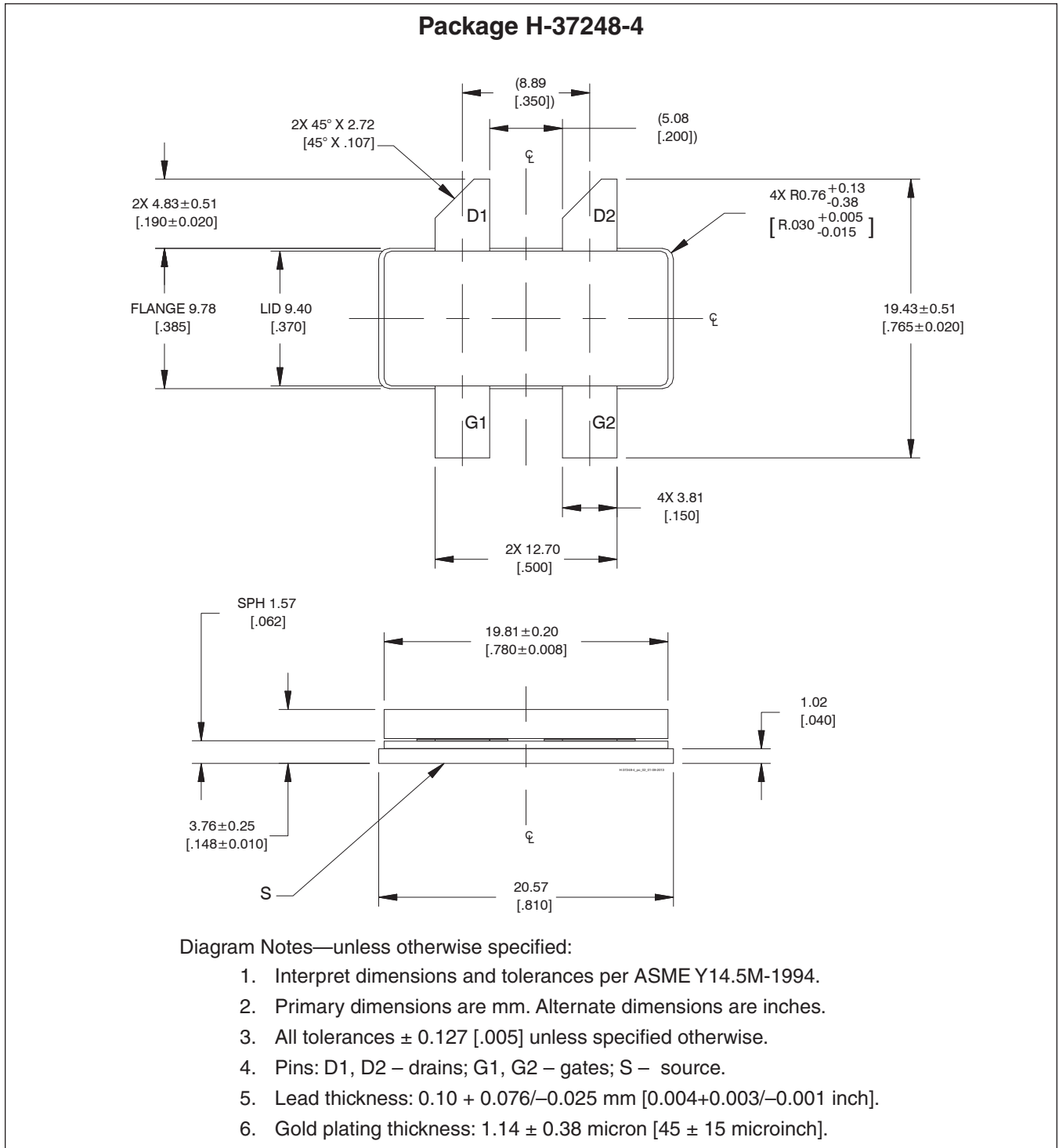

Revision History

Revision	Date	Data Sheet Type	Page	Subjects (major changes since last revision)
01	2012-11-15	Advance	All	Data Sheet reflects advance specification for product development
02p	2012-12-19	Preliminary	All	Data Sheet reflects preliminary specification
03	2013-03-11	Production	All	Data Sheet reflects released product specification
03.1	2013-06-27	Production	1 2	Classified ESD protection Added operating voltage
03.2	2014-05-14	Production	2	Revised junction temperature in Maximum Ratings table
03.3	2015-12-23	Production	2	DC Characteristic table
03.4	2016-06-22	Production	2	Updated ordering information
04	2018-06-29	Production	All	Converted to Wolfspeed Data Sheet

For more information, please contact:

4600 Silicon Drive
Durham, North Carolina, USA 27703
www.wolfspeed.com/RF

Sales Contact
RFSales@wolfspeed.com

RF Product Marketing Contact
RFMarketing@wolfspeed.com
919.407.7816

Notes

Disclaimer

Specifications are subject to change without notice. Cree, Inc. believes the information contained within this data sheet to be accurate and reliable. However, no responsibility is assumed by Cree for any infringement of patents or other rights of third parties which may result from its use. No license is granted by implication or otherwise under any patent or patent rights of Cree. Cree makes no warranty, representation or guarantee regarding the suitability of its products for any particular purpose. "Typical" parameters are the average values expected by Cree in large quantities and are provided for information purposes only. These values can and do vary in different applications and actual performance can vary over time. All operating parameters should be validated by customer's technical experts for each application. Cree products are not designed, intended or authorized for use as components in applications intended for surgical implant into the body or to support or sustain life, in applications in which the failure of the Cree product could result in personal injury or death or in applications for planning, construction, maintenance or direct operation of a nuclear facility.

Компания «Life Electronics» занимается поставками электронных компонентов импортного и отечественного производства от производителей и со складов крупных дистрибьюторов Европы, Америки и Азии.

С конца 2013 года компания активно расширяет линейку поставок компонентов по направлению коаксиальный кабель, кварцевые генераторы и конденсаторы (керамические, пленочные, электролитические), за счёт заключения дистрибьюторских договоров

Мы предлагаем:

- Конкурентоспособные цены и скидки постоянным клиентам.
- Специальные условия для постоянных клиентов.
- Подбор аналогов.
- Поставку компонентов в любых объемах, удовлетворяющих вашим потребностям.
- Приемлемые сроки поставки, возможна ускоренная поставка.
- Доставку товара в любую точку России и стран СНГ.
- Комплексную поставку.
- Работу по проектам и поставку образцов.
- Формирование склада под заказчика.
- Сертификаты соответствия на поставляемую продукцию (по желанию клиента).
- Тестирование поставляемой продукции.
- Поставку компонентов, требующих военную и космическую приемку.
- Входной контроль качества.
- Наличие сертификата ISO.

В составе нашей компании организован Конструкторский отдел, призванный помогать разработчикам, и инженерам.

Конструкторский отдел помогает осуществить:

- Регистрацию проекта у производителя компонентов.
- Техническую поддержку проекта.
- Защиту от снятия компонента с производства.
- Оценку стоимости проекта по компонентам.
- Изготовление тестовой платы монтаж и пусконаладочные работы.



Тел: +7 (812) 336 43 04 (многоканальный)

Email: org@lifeelectronics.ru