

Features

- ◆ Ultra Broad Bandwidth: 50MHz to 26GHz
- ◆ 0.9 Insertion Loss , 38dB Isolation at 20GHz
- ◆ 50nS Switching Speed
- ◆ Reliable, Fully Monolithic, Glass Encapsulated Construction
- ◆ +33dBm Power Handling
- ◆ RoHS Compliant

Description

The MASW-005100-1194 is a SP4T, series-shunt, broad band, PIN diode, switch made with M/A-COM Tech's unique HMIC™ (Heterolithic Microwave Integrated Circuit) process, US Patent 5,268,310. This process allows for the incorporation of silicon pedestals that form the series and shunt diodes or vias by imbedding them in a low loss, low dispersion glass. This hybrid combination of silicon and glass gives HMIC switches exceptional low loss and remarkable high isolation through low millimeter-wave frequencies.

Applications

This high performance switch is suitable for use in multi-band ECM, radar, and instrumentation control circuits where high isolation to insertion loss ratios are required. With a standard +5V/-5V, TTL controlled PIN diode driver, 50nS switching speeds are achieved.

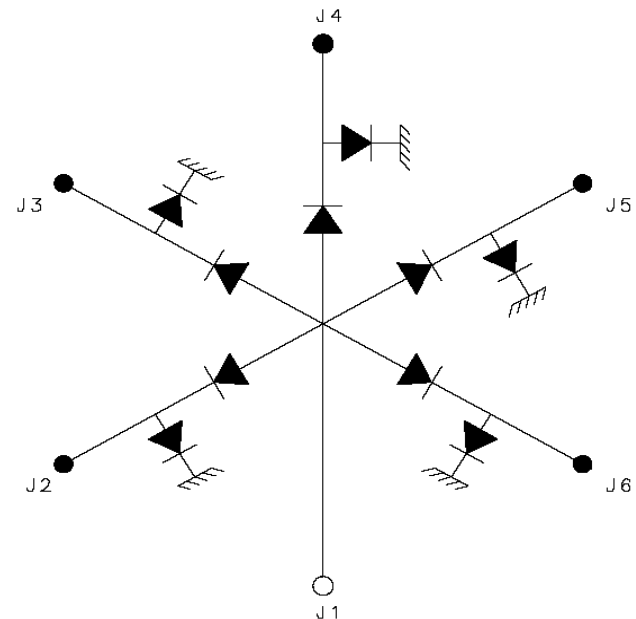
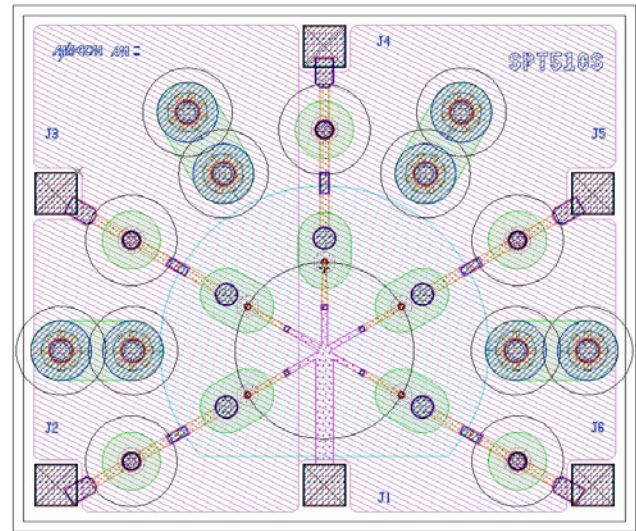

Absolute Maximum Ratings

T_{AMB} = +25°C (Unless Otherwise Specified)

Parameter	Value
Operating Temperature	-65°C to +125°C
Storage Temperature	-65°C to +150°C
RF C.W. Incident Power (± 20mA)	+33dBm
Bias Current (Forward)	± 20mA
Applied Voltage (Reverse)	-25 Volts

Notes:

Exceeding these limits may cause permanent damage.

Maximum operating conditions for the combination of RF Power, D.C. Bias, and temperature: +33dBm, @ 15mA/Diode @ +85°C

ADVANCED: Data Sheets contain information regarding a product M/A-COM Technology Solutions is considering for development. Performance is based on target specifications, simulated results, and/or prototype measurements. Commitment to develop is not guaranteed.
PRELIMINARY: Data Sheets contain information regarding a product M/A-COM Technology Solutions has under development. Performance is based on engineering tests. Specifications are typical. Mechanical outline has been fixed. Engineering samples and/or test data may be available. Commitment to produce in volume is not guaranteed.

• North America Tel: 800.366.2266 • Europe Tel: +353.21.244.6400
 • India Tel: +91.80.43537383 • China Tel: +86.21.2407.1588
 Visit www.macomtech.com for additional data sheets and product information.

M/A-COM Technology Solutions Inc. and its affiliates reserve the right to make changes to the product(s) or information contained herein without notice.

Typical Driver Connections

CONTROL LEVEL (DC CURRENT)					CONDITION OF RF OUTPUT				
J2	J3	J4	J5	J6	J2-J1	J3-J1	J4-J1	J5-J1	J6-J1
-20 mA	+20 mA	+20 mA	+20 mA	+20 mA	Low Loss	Isolation	Isolation	Isolation	Isolation
+20 mA	-20 mA	+20 mA	+20 mA	+20 mA	Isolation	Low Loss	Isolation	Isolation	Isolation
+20 mA	+20 mA	-20 mA	+20 mA	+20 mA	Isolation	Isolation	Low Loss	Isolation	Isolation
+20 mA	+20 mA	+20 mA	-20 mA	+20 mA	Isolation	Isolation	Isolation	Low Loss	Isolation
+20 mA	+20 mA	+20 mA	+20 mA	-20 mA	Isolation	Isolation	Isolation	Isolation	Low Loss

Electrical Specifications

T_{AMB} = 25°C, ± 20 mA bias current (on-wafer measurements)

PARAMETER	FREQUENCY	MIN	TYP	MAX	UNITS
INSERTION LOSS	20GHz		0.9	1.4	dB
ISOLATION	20GHz	28	38		dB
INPUT RETURN LOSS	20GHz		22		dB
OUTPUT RETURN LOSS	20GHz		23		dB
SWITCHING SPEED	10GHz ¹		50		nS

Notes:

Typical switching speed is measured from 10% to 90% of detected RF voltage driven by a TTL compatible driver. Driver output parallel RC network uses a capacitor between 390pF – 560pF and a resistor between 150Ω – 220Ω to achieve 50nS rise and fall times.

Typical Microwave Performance

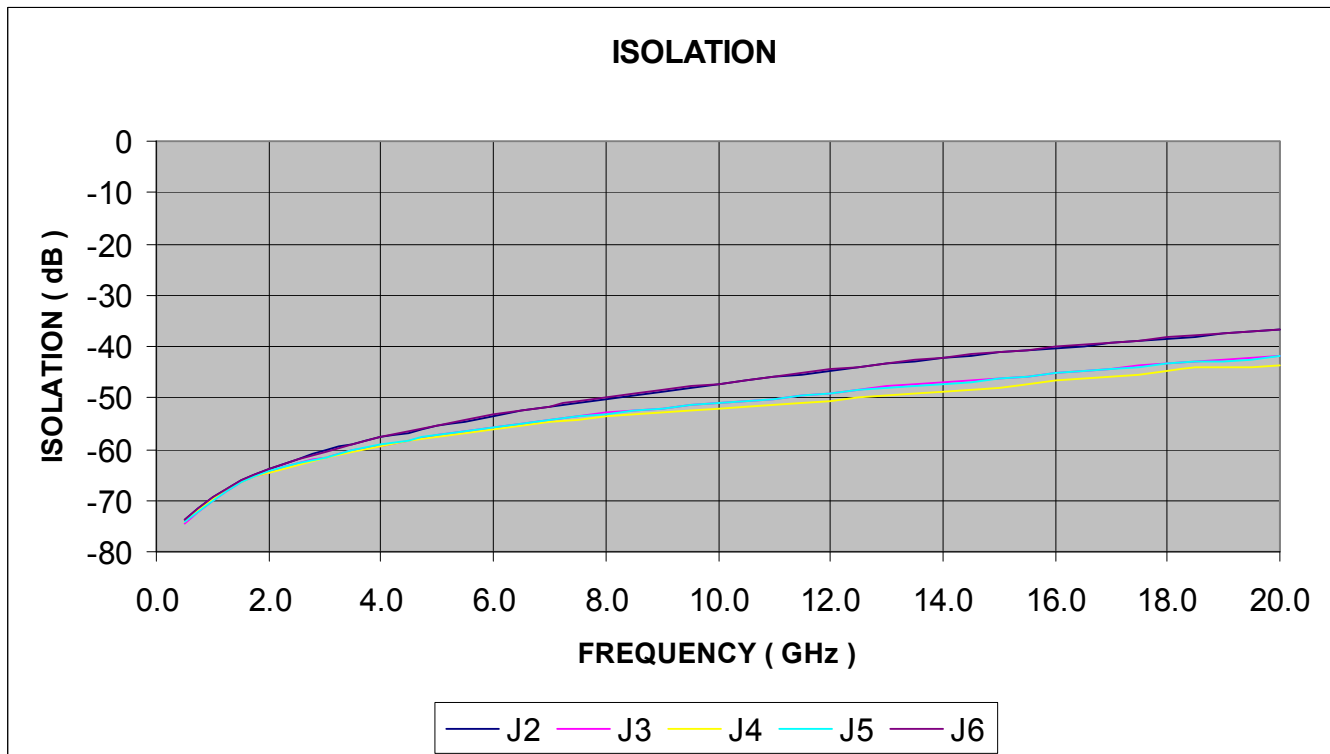
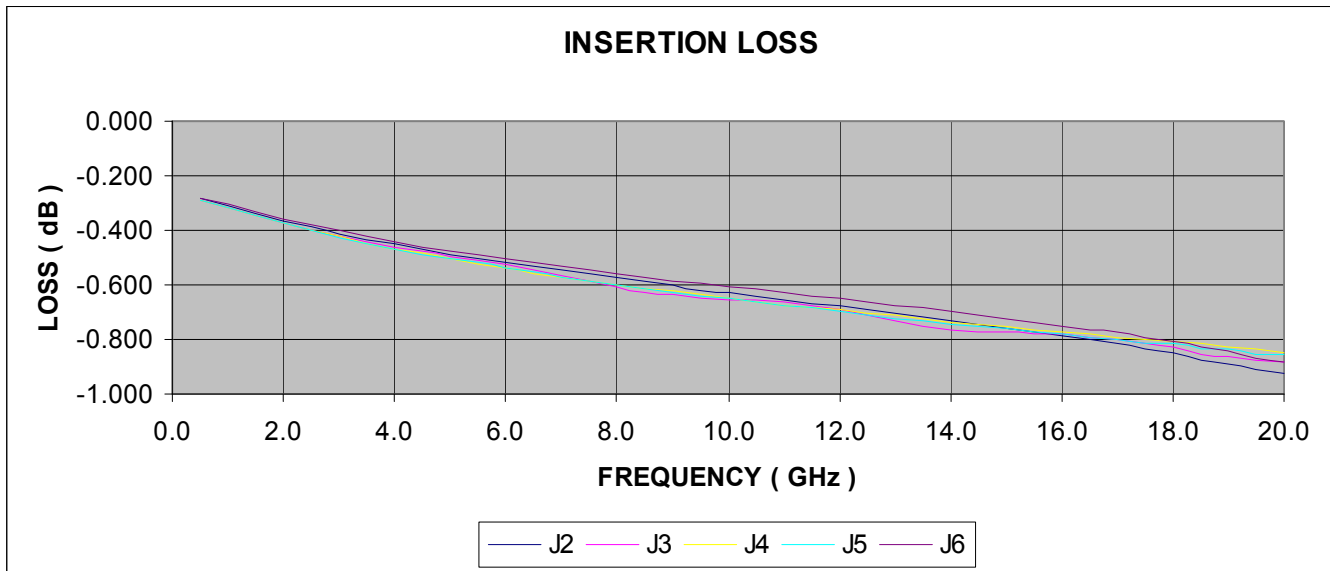

Typical Microwave Performance

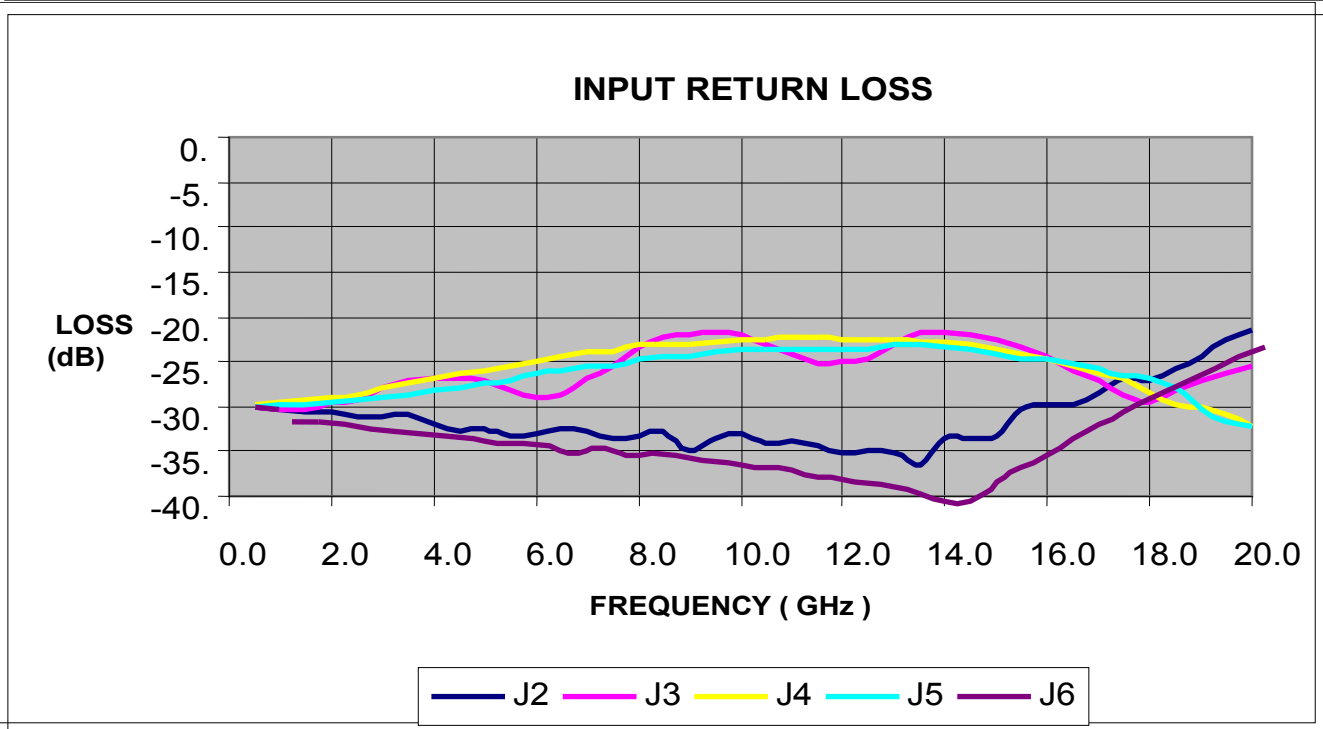
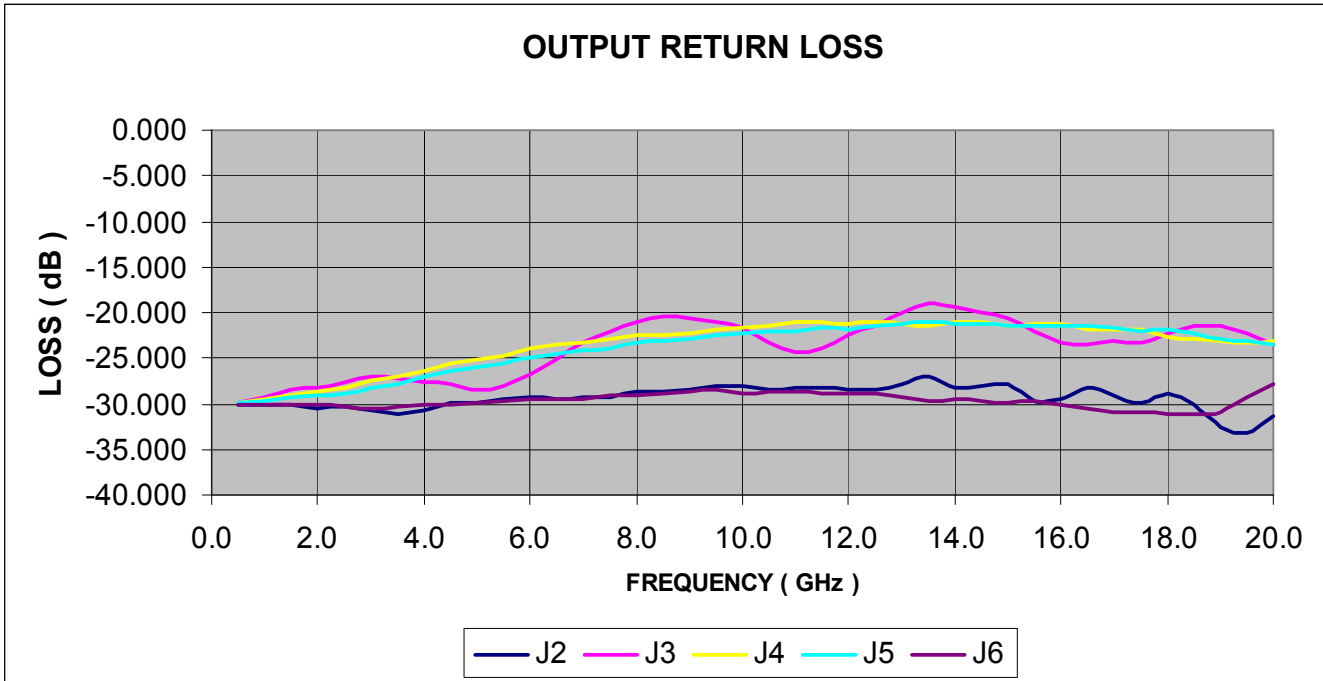

ADVANCED: Data Sheets contain information regarding a product M/A-COM Technology Solutions is considering for development. Performance is based on target specifications, simulated results, and/or prototype measurements. Commitment to develop is not guaranteed.
PRELIMINARY: Data Sheets contain information regarding a product M/A-COM Technology Solutions has under development. Performance is based on engineering tests. Specifications are typical. Mechanical outline has been fixed. Engineering samples and/or test data may be available. Commitment to produce in volume is not guaranteed.

• **North America** Tel: 800.366.2266 • **Europe** Tel: +353.21.244.6400
 • **India** Tel: +91.80.43537383 • **China** Tel: +86.21.2407.1588
 Visit www.macontech.com for additional data sheets and product information.

M/A-COM Technology Solutions Inc. and its affiliates reserve the right to make changes to the product(s) or information contained herein without notice.

Operation of the MASW-005100-1194 Switch

The simultaneous application of negative DC current to the low loss port and positive DC current to the remaining isolated ports as shown in Figure 1 will operate the MASW-005100-1194 PIN diode switch. The backside metalized area of the die is the RF and DC return ground plane. The DC return is achieved on common Port J1. A current source should be used to supply the DC control currents. The voltages at these points will not exceed ±1.5 volts and are typically 1.2 volts for supply currents up to ± 20 mA. For the port in low loss state, the series diode must be forward biased and the shunt diode reverse biased. For all the isolated ports, the shunt diode is forward biased and the series diode is reverse biased. A typical bias network design which should provide >30 dB RF to DC isolation is shown in Figure 1. Best insertion loss, P1dB, IP3, and switching speed are achieved by using a voltage pull-up resistor in the DC return path, J1 (not shown). A minimum value of |-2V| is recommended at this return node and can be obtained using a standard, 65V, TTL controlled, PIN diode driver.

2 – 18 GHz Bias Network Schematic

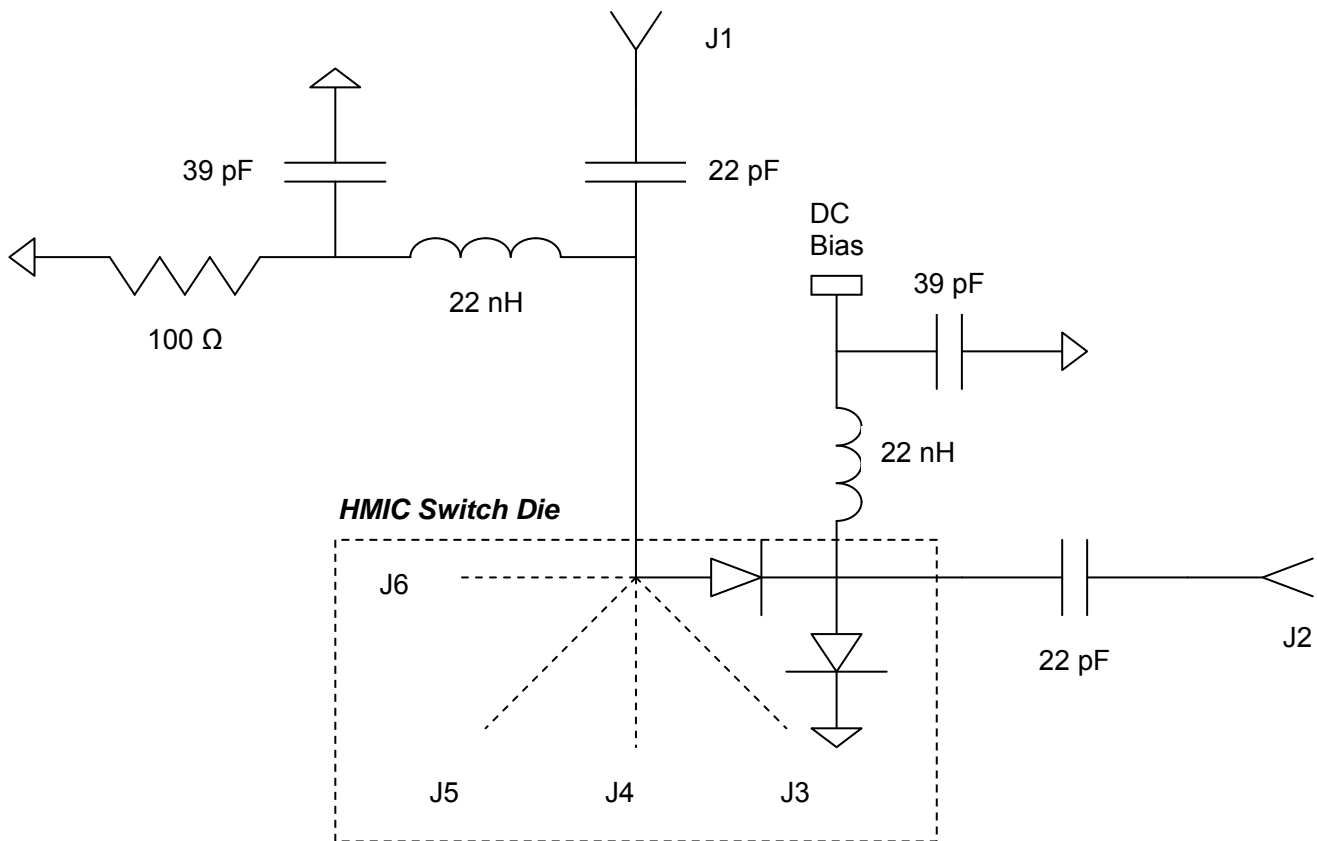

Fig. 1

ASSEMBLY INSTRUCTIONS

Cleanliness

The chip should be handled in a clean environment free of organic contamination.

Electro-Static Sensitivity

The MASW-005100-1194 PIN switch is ESD, Class 1A sensitive (HBM). The proper ESD handling procedures must be used.

Wire Bonding

Thermosonic wedge bonding using 0.003" x 0.00025" ribbon or 0.001" diameter gold wire is recommended. A stage temperature of 150°C and a force of 18 to 22 grams should be used. Ultrasonic energy, if necessary, should be adjusted to the minimum power required to achieve a good bond. RF wire and ribbon lengths should be kept as short as possible to minimize parasitic inductance.

Mounting

These chips have Ti-Pt-Au back metal and can be mounted using 80Au/20Sn eutectic solder or electrically conductive Ag epoxy. Mounting surface must be flat and clean of oils and contaminants.

Eutectic Die Attachment

An 80/20 gold-tin eutectic solder preform is recommended with a work surface temperature of 255°C and a tool tip temperature of 265°C. When hot gas is applied, the tool tip temperature should be 290°C. The chip should not be exposed to temperatures greater than 320°C for more than 10 seconds. No more than 3 seconds should be required for the die attachment.

Silver Epoxy Die Attachment

A controlled thickness of no more than 2 mils is recommended for the best electrical and thermal conductivity. A thin epoxy fillet should be visible around the perimeter of the chip after placement to ensure complete coverage. Cure epoxy per manufacturer's recommended schedule. Typically +150°C for 1 hour.

**MASW-005100-1194
Chip Dimensions**

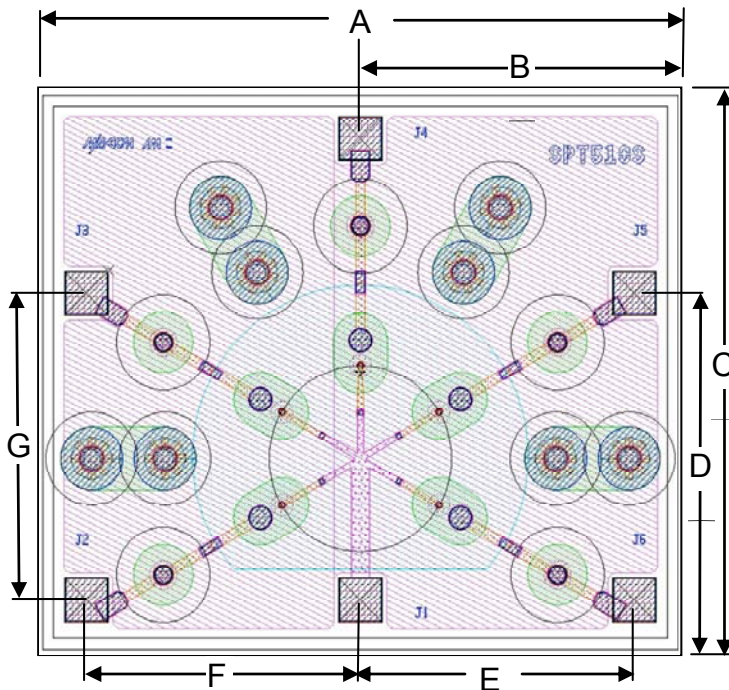

Chip Dimensions*

DIM	INCHES	µM
A	0.0680	1723
B	0.0340	858
C	0.0580	1473
D	0.0370	938
E	0.0295	750
F	0.0295	750
G	0.0325	825
All Pads	.005 X .005	120 X 120
Thickness	0.005	127

*All chip dimension tolerances are ±.0005"

ORDERING INFORMATION

Part Number	Package
MASW-005100-11940W	Waffle Pack
MASW-005100-11940G	Gel Pack

Компания «Life Electronics» занимается поставками электронных компонентов импортного и отечественного производства от производителей и со складов крупных дистрибьюторов Европы, Америки и Азии.

С конца 2013 года компания активно расширяет линейку поставок компонентов по направлению коаксиальный кабель, кварцевые генераторы и конденсаторы (керамические, пленочные, электролитические), за счёт заключения дистрибьюторских договоров

Мы предлагаем:

- Конкурентоспособные цены и скидки постоянным клиентам.
- Специальные условия для постоянных клиентов.
- Подбор аналогов.
- Поставку компонентов в любых объемах, удовлетворяющих вашим потребностям.
- Приемлемые сроки поставки, возможна ускоренная поставка.
- Доставку товара в любую точку России и стран СНГ.
- Комплексную поставку.
- Работу по проектам и поставку образцов.
- Формирование склада под заказчика.
- Сертификаты соответствия на поставляемую продукцию (по желанию клиента).
- Тестирование поставляемой продукции.
- Поставку компонентов, требующих военную и космическую приемку.
- Входной контроль качества.
- Наличие сертификата ISO.

В составе нашей компании организован Конструкторский отдел, призванный помогать разработчикам, и инженерам.

Конструкторский отдел помогает осуществить:

- Регистрацию проекта у производителя компонентов.
- Техническую поддержку проекта.
- Защиту от снятия компонента с производства.
- Оценку стоимости проекта по компонентам.
- Изготовление тестовой платы монтаж и пусконаладочные работы.



Тел: +7 (812) 336 43 04 (многоканальный)
Email: org@lifeelectronics.ru