

## LARISA-O-PIN

~40° x 20° oval beam and holder with location pins

### TECHNICAL SPECIFICATIONS:

Dimensions	9.9 mm
Height	7.5 mm
Fastening	glue, pin
ROHS compliant	yes ⓘ

### MATERIAL SPECIFICATIONS:

Component	Type	Material	Colour	Finish
LARISA-O	Single lens	PMMA	clear	
LARISA-HOLDER-PIN	Holder	PC	black	

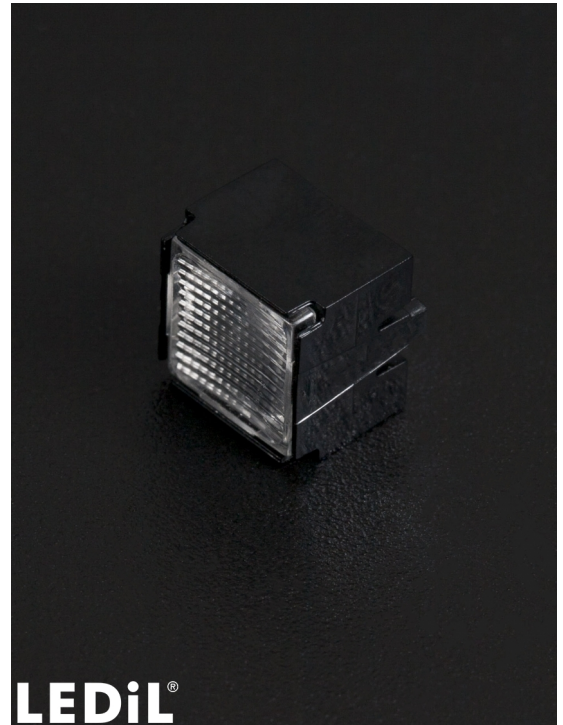

### ORDERING INFORMATION:

Component		Qty in box	MOQ	MPQ	Box weight (kg)
CP15306_LARISA-O-PIN	Single lens	10000	300	100	7.1
» Box size: 300 x 250 x 250 mm					

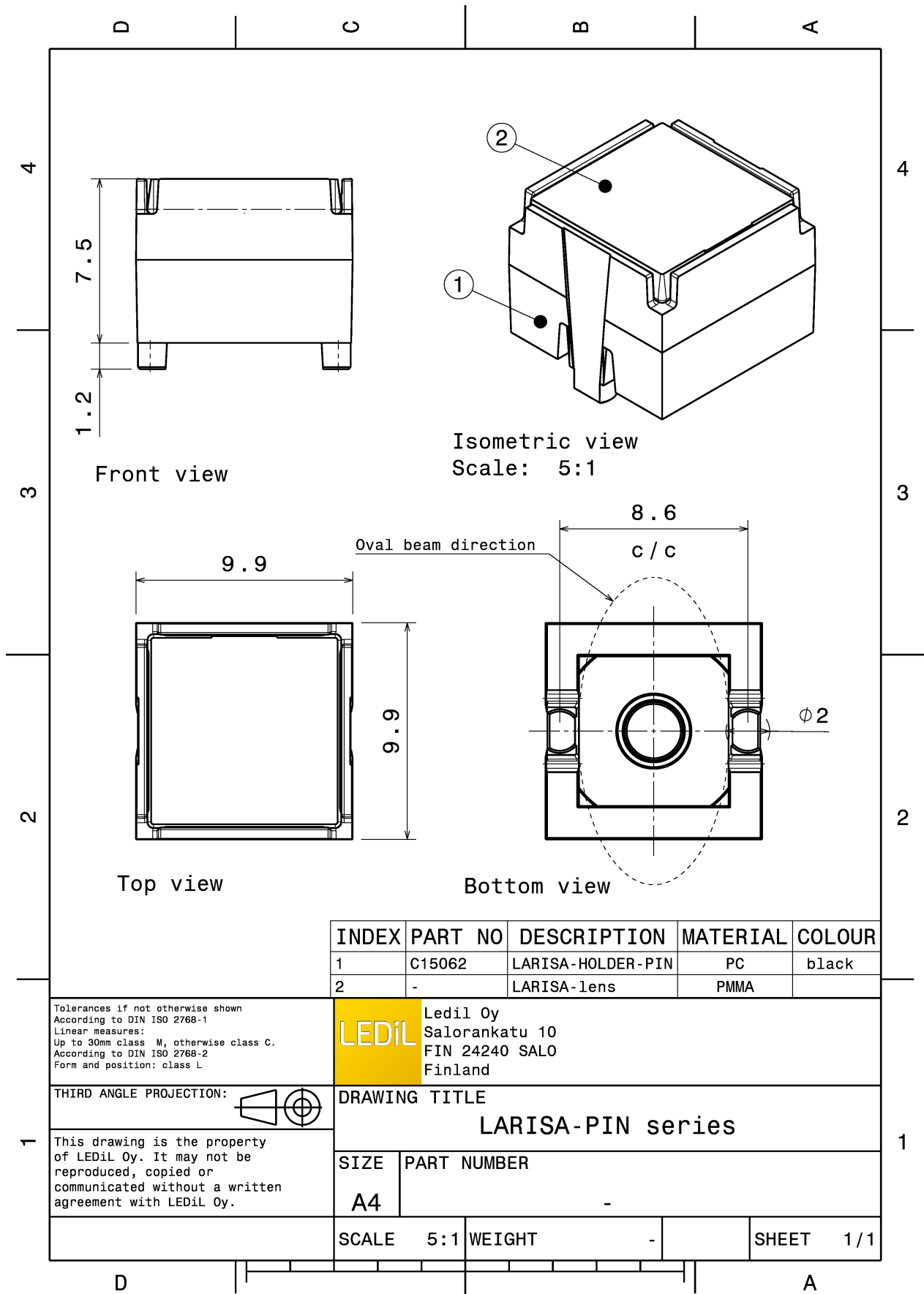

#### PHOTOMETRIC DATA (MEASURED):

#### CREE

LED XD16  
 FWHM 40.0 + 20.0°  
 Efficiency 75 %  
 Peak intensity 2.1 cd/lm  
 LEDs/each optic 1  
 Light colour White  
 Required components:

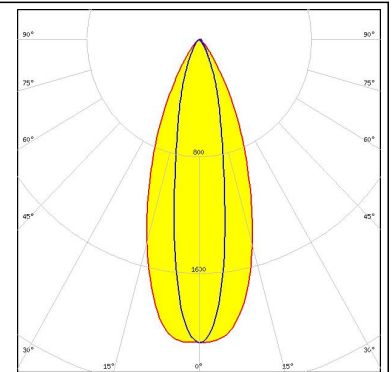
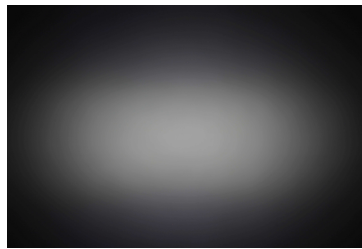

#### CREE

LED XQ-E HD  
 FWHM 40.0 + 17.0°  
 Efficiency 82 %  
 Peak intensity 2.8 cd/lm  
 LEDs/each optic 1  
 Light colour White  
 Required components:

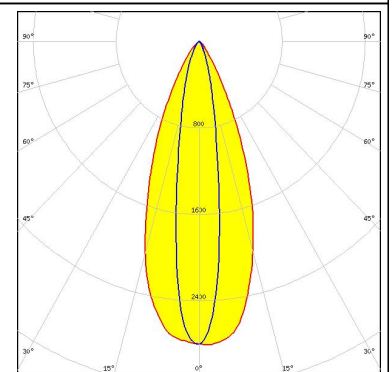
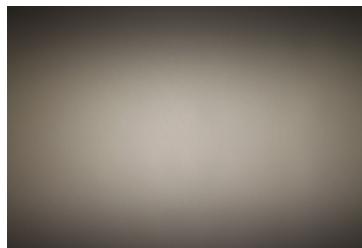

#### CREE

LED XQ-E HI  
 FWHM 43.0 + 14.0°  
 Efficiency 79 %  
 Peak intensity 3.1 cd/lm  
 LEDs/each optic 1  
 Light colour White  
 Required components:

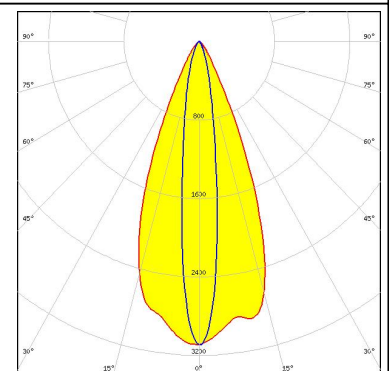
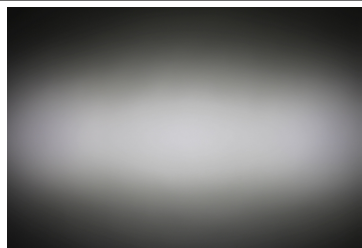

#### LUMILEDS

LED LUXEON C  
 FWHM 40.0 + 18.0°  
 Efficiency 79 %  
 Peak intensity 2.6 cd/lm  
 LEDs/each optic 1  
 Light colour White  
 Required components:

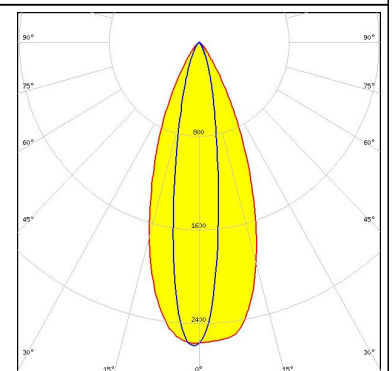
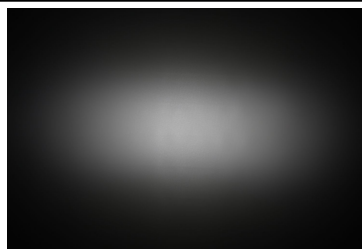

#### PHOTOMETRIC DATA (MEASURED):



LED LUXEON Z  
 FWHM 42.0 + 14.0°  
 Efficiency 79 %  
 Peak intensity 3.2 cd/lm  
 LEDs/each optic 1  
 Light colour White  
 Required components:

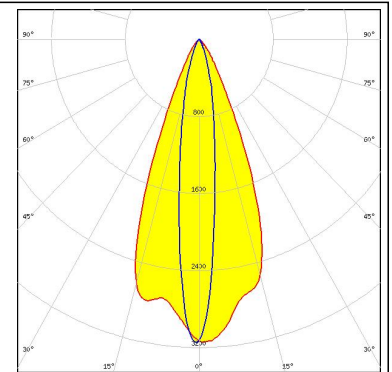

LED NCSxE17A  
 FWHM 42.0 + 19.0°  
 Efficiency 68 %  
 Peak intensity 1.9 cd/lm  
 LEDs/each optic 1  
 Light colour White  
 Required components:

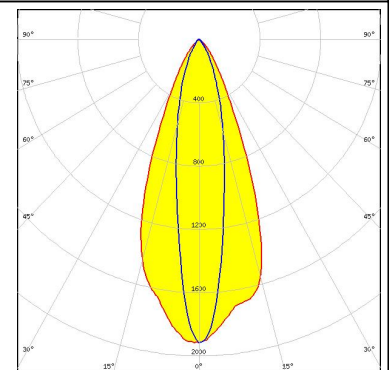
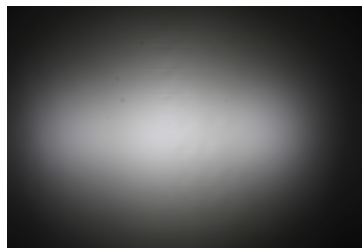

LED NVSxE21A  
 FWHM 43.0 + 22.0°  
 Efficiency 65 %  
 Peak intensity 1.5 cd/lm  
 LEDs/each optic 1  
 Light colour White  
 Required components:

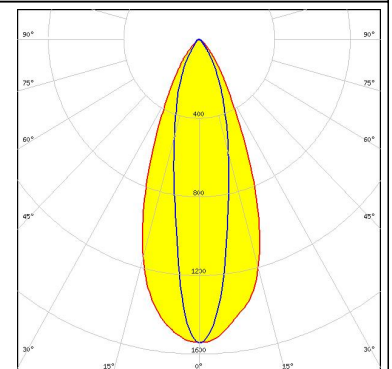
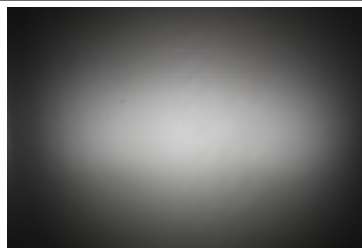

LED OSLOM SSL 80  
 FWHM 40.0 + 17.0°  
 Efficiency 77 %  
 Peak intensity 2.5 cd/lm  
 LEDs/each optic 1  
 Light colour White  
 Required components:

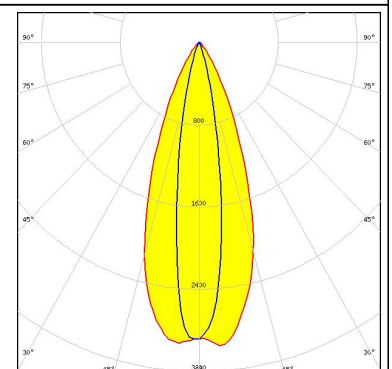
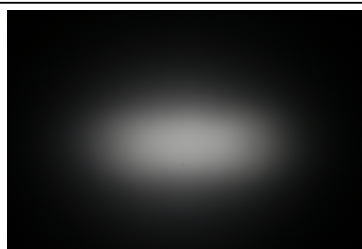

### GENERAL INFORMATION:

NOTE: The typical beam angle will be changed by different color, chip size and chip position tolerance. The typical total beam angle is the full angle measured where the luminous intensity is half of the peak value.

### MATERIALS:

As part of our continuous research and improvement processes, and to ensure the best possible quality and availability of our products, LEDiL reserves the right to change material grades without notice.

### PRODUCT DATA USER AGREEMENT AND DISCLAIMER:

The measured data in the provided downloadable LEDiL Product Datasheets and Mechanical 2D-Drawings is rounded and provided as reference for planning. LEDiL Oy's optical specifications have been verified by conducting performance testing of the products in accordance with the company's quality system. The reported data are averaged results of multiple measurements with typical variation. LEDiL Oy reserves the right to without prior notification make changes and improvements to its products.

LEDiL Oy assumes neither warranty, nor guarantee nor any other liability of any kind for the contents and correctness of the provided data. The provided data has been generated with highest diligence but the provided data may in reality not represent the complete possible variation range of all intrinsic parameters. Therefore, in certain cases a deviation from the provided data could occur.

LEDiL Oy reserves the right to undertake technical changes of its products without further notification which could lead to changes in the provided data. LEDiL Oy assumes no liability of any kind for the possible deviation from any provided data or any other damage resulting from the usage of the provided data.

The user agrees to this disclaimer and user agreement with the download or usage of the provided files.

#### LEDiL Oy

Joensuunkatu 13  
FI-24240 SALO  
Finland

#### LEDiL Inc.

228 West Page Street  
Suite D  
Sycamore IL 60178  
USA

#### Local sales and technical support

[www.ledil.com/  
where\\_to\\_buy](http://www.ledil.com/where_to_buy)

#### Shipping locations

Salo, Finland  
Hong Kong, China

#### Distribution Partners

[www.ledil.com/  
where\\_to\\_buy](http://www.ledil.com/where_to_buy)



Компания «Life Electronics» занимается поставками электронных компонентов импортного и отечественного производства от производителей и со складов крупных дистрибьюторов Европы, Америки и Азии.

С конца 2013 года компания активно расширяет линейку поставок компонентов по направлению коаксиальный кабель, кварцевые генераторы и конденсаторы (керамические, пленочные, электролитические), за счёт заключения дистрибьюторских договоров

Мы предлагаем:

- Конкурентоспособные цены и скидки постоянным клиентам.
- Специальные условия для постоянных клиентов.
- Подбор аналогов.
- Поставку компонентов в любых объемах, удовлетворяющих вашим потребностям.
- Приемлемые сроки поставки, возможна ускоренная поставка.
- Доставку товара в любую точку России и стран СНГ.
- Комплексную поставку.
- Работу по проектам и поставку образцов.
- Формирование склада под заказчика.
- Сертификаты соответствия на поставляемую продукцию (по желанию клиента).
- Тестирование поставляемой продукции.
- Поставку компонентов, требующих военную и космическую приемку.
- Входной контроль качества.
- Наличие сертификата ISO.

В составе нашей компании организован Конструкторский отдел, призванный помогать разработчикам, и инженерам.

Конструкторский отдел помогает осуществить:

- Регистрацию проекта у производителя компонентов.
- Техническую поддержку проекта.
- Защиту от снятия компонента с производства.
- Оценку стоимости проекта по компонентам.
- Изготовление тестовой платы монтаж и пусконаладочные работы.



Тел: +7 (812) 336 43 04 (многоканальный)

Email: [org@lifeelectronics.ru](mailto:org@lifeelectronics.ru)