

Amphenol

Amphenol-Tuchel Electronics GmbH

Smart Card Connectors Series C700



www.smart-card-connector.info

Our project competence for your innovative solutions

Amphenol's development strategy is to partner with customers early in their development process. We bring a high level expertise to programs in an effort to achieve innovative designs that meet current and future needs. Important elements are especially:

Sample shop and pre-series production capability

- Stamped bended and milled parts
- Injection molding and stamping tools

Engineering tools

- Structural analysis with FEM
- Dynamic FEM Analysis
- 3D process simulation of injection molding
- Network of service provider
- Rapid Prototyping
- Simultaneous Engineering of Product Design and Development of Processes



Internal Research & Testing Laboratory

Mechanical endurance & forces

- mechanical shock testing
- contact force characteristics
- vibration testing (sine or random)

Materials & Surfaces

- coating thickness measuring
- material hardness
- visual inspection by microscope
- microsections

Product Assessment

- operating life testing
- electrical parameters
- Environmental testing, mating cycles



Contents

Mating Cycles	500 000	C702 F p. 19		C703 A p. 8
				C702 A p. 10
				C702 B p. 12
	300 000		C702 D p. 14	C702 C p. 15
				C702 Y p. 15
	100 000	C702 E p. 16		
		C707 A p. 20		
	< 100 000	C707 B p. 22		
		C707 D p. 23		
				PCB Assembly

Global Partnership

The Company

Amphenol-Tuchel Electronics GmbH is a global company and leading manufacturer of electrical connector solutions.

The superior quality of our product line is a result of specialized engineering and techniques in conjunction with leading edge production methods.

Our worldwide production and sales channels provide local competency in a global marketplace. Amphenol has continually upped the standards in electrical connector technology with our many inventions and patents.

Our Smart Card solutions are used in applications such as payment terminals, Set Top Boxes, vending machines, access control units and also in the automotive market. Global Partnership



Quality

At Amphenol-Tuchel Electronics, quality is one of the first considerations during the initial development steps.

For more than 20 years our interdisciplinary project teams have guaranteed robust and reliable Smart Card solutions.

Amphenol-Tuchel is certified in accordance with ISO 9001, QS 9000, VDA 6.1 and TS 16949, which means that each step in the process chain ensures a maximum quality level. Our environmental awareness is oriented

Technological Leadership

Amphenol-Tuchel Electronics has obtained its claims to technical advances and technological leadership from various technical and technological advantages.

These include high-performance precision pressing technology, modern injection-molding technology and a manufacturing and inspection technology which ensures that all processes operate reliably.

Production flexibility is guaranteed by the use of either fully automatic production equipment, semi-automatic production lines or manual manufacture, depending on the requirements.



General Information

Card Handling Systems

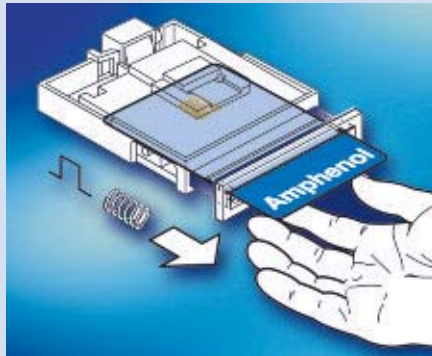
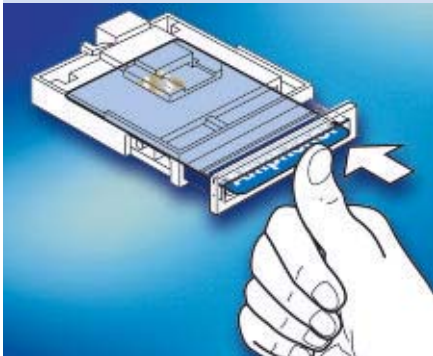
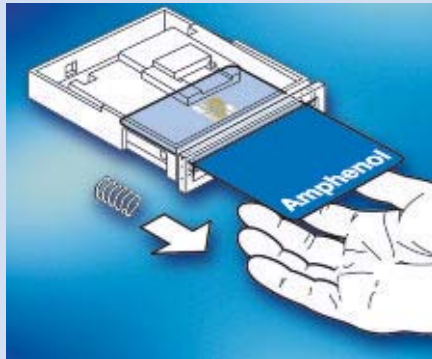
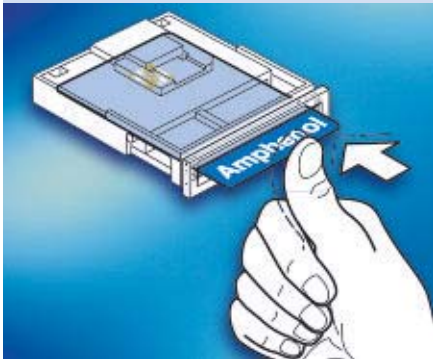
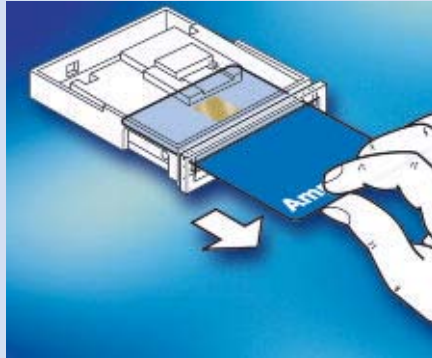
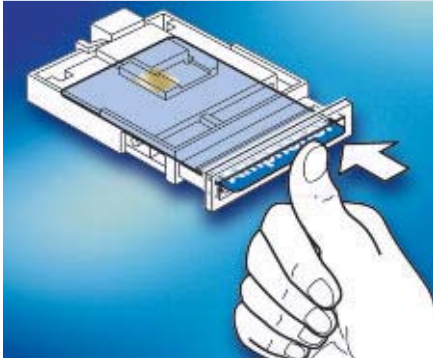
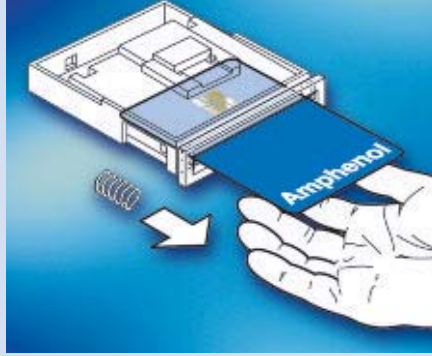
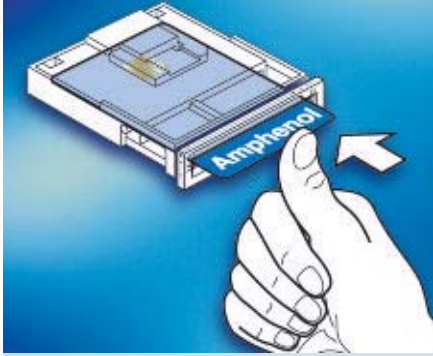

Push-Only

The card is inserted manually and held in the active position by hand. The card is ejected immediately after the user releases it. The Push-Only is ideally suited for applications with short transaction cycles, i.e. door access control.

Push-Pull

The card is inserted manually and held in the active position by a card brake. After completion of the transaction, the card is simply pulled out of the Smart Card Connector.

This is the most common manual cardhandling system.

Push-Push

The card is inserted manually and held in the active position by the Smart Card Connector. When pushed again the card is returned to the user (principle of a ballpointpen).

PUSHMATIC®

This semi-automatic system combines a manual card insertion with an automatic card ejection. The card is manually pushed into the Smart Card Connector until it is flush (or nearly flush) with the bezel.

Upon completion of the transaction, software triggers a solenoid and the card is ejected back to the user.

Contact Methods

Landing Contacts

With this contact method a moveable contact set will connect with the pads of the chip card upon insertion of the card. The card plastic surface is not scratched and highmating cycles can be achieved.

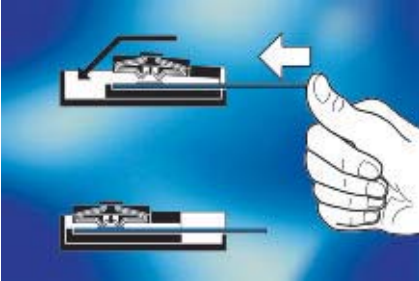

Wiping Contacts

The contact set is fixed. When the card is inserted, it wipes over the data contacts until they arrive at the card pads. Depending upon the card surface, wiping traces which do not influence the card function can occur after some insertion cycles. The advantage of wiping contacts is that they clean the contact point with every mating cycle.

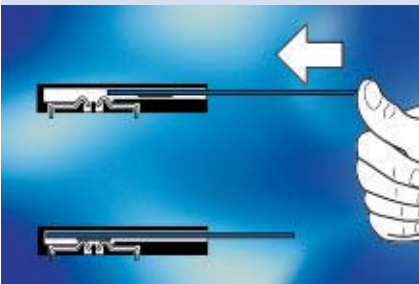

Landing Card

This method of contacting is based on a fixed contact set. The chip card is lowered during its insertion. The contact areas of the chip card land smoothly on the reading contacts which results in the possibility of a high number of mating cycles. In addition this system makes sure that with each insertion the contact surfaces are cleaned.

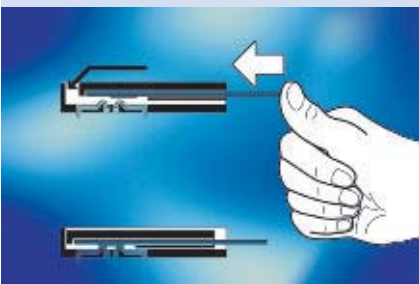

SIMLOCK®

In cases where chip cards with the dimensions of a full size ISO 7816 are too large, the SIMLOCK® comes into use. With its latching cover for the insertion of the smaller SIM card it offers a safe contact interface even in mobile usage. Due to the locking system the user does not have to consider tolerances or card guiding. The design and packaging of the Amphenol SIMLOCK® allows manual and automatic pick and placement prior to surface mount soldering.

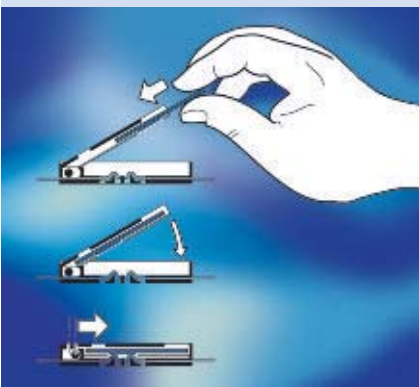

SIMBLOCK®

These Smart Card Connectors, due to their minimal space requirement and low height are the ideal components for many space restricted applications, from handsets to the electronic purse. The connector is suitable for standard chip cards per ISO 7816 as well as for plug-in SIM cards.

The SMT terminals and packaging for automatic handling allow the use of pick and place robots and modern surface solder technologies. Positioning and support of the chip card has to be ensured by the user.

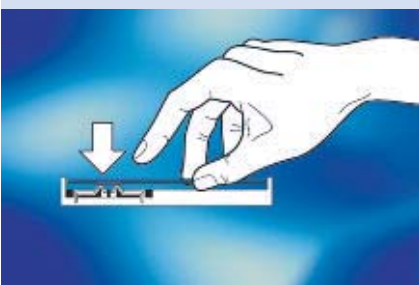

C703A Hybrid

C703A Hybrid Push-Pull



PCI PED protection for both chip and magnetic head available

- 500.000 mating cycles for both chip and magnetic stripe
- landing, self-cleaning contacts
- gimbaled magnetic head
- card presence switch
- compact design for space critical applications
- card guiding for secure card reading
- EMV compliant

PART NO.:

C703 10M008 600 5	standard magnetic head, with card break
C703 10M008 601 5	standard magnetic head, no card break
C703 10M008 609 5	superflat magnetic head, no card break

C703A Hybrid PUSHMATIC®



PCI PED protection for both chip and magnetic head available

- 500.000 mating cycles for both chip and magnetic stripe
- landing, self-cleaning contacts
- gimbaled magnetic head
- card presence and locking switch
- card locking in active position
- compact design for space critical applications
- card guiding for secure card reading
- EMV compliant

PART NO.:

C703 10M008 607 5	12V solenoid
-------------------	--------------

C703A Hybrid EMV



- *super flat hybrid reader*
- *EMV Level 1 compliant*

PART NO.:

C703 10M008 606 5 EMV Level 1 Modul

customized software interfaces / PCB solutions available upon request



C703A Hybrid Swipe



- *500.000 mating cycles for both chip and magnetic stripe*
- *landing, self-cleaning contacts*
- *several magnetic heads available*
- *card presence switch*
- *approved card handling for magnetic stripe reading*
- *EMV compliant*

PART NO.:

C703 10M008 610 5 standard magnetic head



PCI PED protection for both chip and magnetic head available

C702A Vario

C702A Vario



- 500.000 mating cycles
- landing, self-cleaning contacts
- card presence switch
- accessories available

PART NO.:

C702 10M008 015 2	Push-Push
C702 10M008 018 2	Push-Only
C702 10M008 514 2	Push-Pull

C702A PUSHMATIC®



- 300.000 mating cycles
- landing, self-cleaning contacts
- card presence switch
- accessories available

PART NO.:

C702 10M008 701 2	5V, flat cable termination
C702 10M008 700 2	12V, flat cable termination
C702 10M008 702 2	24V, flat cable termination
C702 10M008 747 2	5V, flexprint termination
C702 10M008 723 2	12V, flexprint termination
C702 10M008 772 2	24V, flexprint termination
C702 10M008 732 2	5V, flat cable, locking detector
C702 10M008 716 2	12V, flat cable, locking detector
C702 10M008 727 2	24V, flat cable, locking detector

C702A Shutter



- 200.000 mating cycles
- landing, self-cleaning contacts
- card presence switch
- mounting plate

PART NO.:

C702 20M008 701 2	5V
C702 20M008 700 2	12V
C702 20M008 702 2	24V

C702A Accessories



- customized bezels on request

PART NO.:

C702 N13 030 E2 (for PUSHMATIC)	metal bezel, silver coloured
C702 N13 031 E2 (for PUSHMATIC)	metal bezel, black coloured
C702 N14 030 E2 (for PUSHMATIC)	metal bezel with coin spacer, silver coloured
C702 N15 100 G2	mounting plate
C702 N11 141 E2	plastic bezel, black
C702 N14 000 G2	Shutter

C702B PUSHMATIC® II

C702B PUSHMATIC® II without card locking



- *robust design, suitable for vending machines*
- *card accessible during power failure*
- *card presence switch, also can be used for system wake up*
- *card end position switch acc. to EMV acts as card locking sensor*
- *additional sensor for card active position detects abnormal termination of the transaction*
- *self retracting and self cleaning data contacts provide protection against vandalism*
- *housing bottom features a large debris slot allowing the egress of coins, paper, as well as cut in half cards*
- *16 way interface header allows for custom cabling*
- *300.000 mating cycles*

PART NO.:

C702 10M008 906 2	5V	solenoid voltage
C702 10M008 904 2	12V	solenoid voltage
C702 10M008 909 2	24V	solenoid voltage

C702B PUSHMATIC® II with card locking



- *card locked in active position*
- *robust design, suitable for vending machines*
- *card accessible during power failure*
- *card end position switch acc. to EMV acts as card locking sensor*
- *additional sensor for card active position detects abnormal termination of the transaction*
- *self retracting and self cleaning data contacts provide protection against vandalism*
- *housing bottom features a large debris slot allowing the egress of coins, paper, as well as cut in half cards*
- *16 way interface header allows for custom cabling*
- *300.000 mating cycles*
- *as an option feature to release card in locked position (SCR)*

PART NO.:

C702 10M008 907 2	5V	solenoid voltage
C702 10M008 905 2	12V	solenoid voltage
C702 10M008 910 2	24V	solenoid voltage

C702B Accessories



- *Amphenol's original guarantees well function*

PART NO.:

C702 G46 100 G2	metal bezel with "coin spacer" silver coloured
C702 G46 201 G2	metal bezel with "coin spacer" and rain refusing, silver coloured
C702 G51 112 E2	mounting plate, tin plated
C702 N25 040 E2	plastic adapter for common standard bezels

C702D Flex

Amphenol

C702D Flex Basis



- *miniaturized style, ideally suited for mobile devices like POS terminals*
- *EMV compatible*
- *300.000 mating cycles*
- *with flexprint termination to save boardspace*

PART NO.:

C702 10M008 065 4 EMV compliant

C702D Flex Snap in



- *snap in mounting, chip side up card insertion*
- *debris slot to provide egress of coins, paper*
- *miniaturized style, ideally suited for mobile devices like POS terminals*
- *EMV compatible*
- *300.000 mating cycles*
- *with flexprint termination and as an option dip solder version*

PART NO.:

C702 10M008 063 4 Dip Solder, EMV compliant
C702 10M008 066 4 Flexprint, EMV compliant

C702C PUSHMATIC® Slim

C702C PUSHMATIC® Slim



- 300.000 mating cycles
- landing, self-cleaning contacts
- card locking in active position
- automatic card ejection after transaction
- manual unlocking after power failure possible
- card presence and locking switch
- EMV compliant

PART NO.:

C702 10M008 901 4	5V
C702 10M008 902 4	12V
C702 20M008 903 4	24V

C702C Automotive Connector

C702C Automotive Connector



- designed according to automotive requirements
- card locking
- ejection over solenoid
- integrated dust protection
- working temperature -40 °C – +85 °C
- shock resistance min. 20 G (in direction of solenoid axis)
- min. 25.000 mating cycles
- ROHS, WEEE conform

PART NO.:

C702 10M008 925 4

C702E Wiping

C702E Wiping XXS



- *self cleaning card present switch*
- *normally open or normally closed switch*
- *boardlocks for mechanical fixation*
- *special shape of contacts minimizes card scratching*
- *PCB mounting, dip solder pins*
- *dimensions 62x40x7.2 mm*
- *100.000 mating cycles*
- *EMV compliant*

PART NO.:

C702 10M008 230 40	XXS Standard, normally closed switch
C702 10M008 231 40	XXS Standard, normally open switch
C702 10M008 232 40	XXS 3mm stand-off, normally closed switch
C702 10M008 233 40	XXS 3mm stand-off, normally open switch
C702 10M008 234 40	XXS 5mm stand-off, normally closed switch
C702 10M008 235 40	XXS 5mm stand-off, normally open switch

C702E Wiping Dual Plane



- *Dual Plane version with 2 x 8 contacts for chip up & down card handling*
- *self cleaning card present switch*
- *normally closed switch*
- *boardlocks for mechanical fixation*
- *special shape of contacts minimizes card scratching*
- *PCB mounting, dip solder pins*
- *100.000 mating cycles*
- *EMV compliant design*
- *suitable for applications with shorter dwell time of the card*

PART NO.:

C702 10M008 214 40	Dual Plane
--------------------	------------

C702E Wiping Card Guide



- *Smart Card connector with Card Guide*
- *self cleaning card present switch*
- *normally closed switch*
- *boardlocks for mechanical fixation*
- *special shape of contacts minimizes card scratching*
- *PCB mounting, dip solder or SMT*
- *100.000 mating cycles*

PART NO.:

C702 10M008 283 4 Card Guide 3mm stand-off, dip solder pin

C702 10M008 230 4 Card guide, SMT, 8 contacts ISO, infrared reflow 230°C, 30 s max.

C702E Wiping Panel Mount



- *collar for snap in mounting in front panel*
- *self cleaning card present switch*
- *normally closed switch*
- *special shape of contacts minimizes card scratching*
- *connection to the PCB with Flexprint*
- *100.000 mating cycles*
- *EMV compliant*

PART NO.:

C702 10M008 240 40 Panel Mount

C702E Wiping

Amphenol

C702E PCB-Slimline



- extremely compact dimensions (56 x 30 x 3 mm)
- metal cover for high mechanical stability (only one card in slot)
- protected switch
- for pick & place assembly
- reflow compliant
- 100,000 mating cycles

PART NO.:

- | | |
|--------------------|--------------------|
| C702 10M008 252 40 | with position pins |
| C702 10M008 251 40 | with flexprint |



PCI PED protection available

C702Y Landing EZ

C702Y Landing EZ



- 300.000 mating cycles
- landing, self-cleaning contacts
- card presence switch
- flat cable and flexprint termination

PART NO.:

- | | |
|-------------------|--|
| C702 10M008 071 3 | integrated bezel,
flat cable termination |
| C702 10M008 009 3 | bilateral mounting,
Flexprint termination |

C702F PCB Landing

Amphenol

C702F PCB Landing



- 500.000 mating cycles
- landing, self-cleaning contacts
- tap-proof design (no pins in front area)
- PCI card slot regulation compliant - only one card in slot
- protected card presence switch
- EMV compliant

PART NO.:

C702 10M008 300 4 without PCI PED cover

DISCONTINUED!



PCI PED protection available

C703 Hybrid Adapter



- hybrid adapter for PCB landing connector
C702 10M008 300 4
- 3 track magnetic head
- customized flexprint termination

PART NO.:

C703 10M008 608 5 standard magnetic head



PCI PED protection for magnetic head available

C707A SIMLOCK®

C707A SIMLOCK® new generation



- height: 2.5 mm
- packaging: tape & reel
- wide solder tails for overhead soldering as an option
- for SIM/SAM applications
- designer does not have to be concerned with housing tolerances and card guiding due to self contained system
- locking detector and card detection switch as an option

PART NO.:

C707 10M006 049 2	w/o locking detector and card presence switch, 2 positioning pins
C707 10M006 500 2	w/o locking detector and card presence switch, w/o positioning pins
C707 10M006 523 2	with locking detector and card presence switch, 2 positioning pins
C707 10M006 522 2	with locking detector and card presence switch, w/o positioning pins
C707 10M006 530 2	wide solder tails, w/o locking detector and card presence switch, w/o positioning pins
C707 10M006 537 2	wide solder tails, with locking detector and card presence switch, w/o positioning pins
C707 10M006 542 2	alternative footprint, w/o locking detector and card presence switch, w/o positioning pins

C707A SIMLOCK® shielded



- height: 2.5 mm
- packaging: tape & reel
- for SIM/SAM applications
- designer does not have to be concerned with housing tolerances and card guiding due to self contained system
- locking detector and card detection switch
- full metallized cover with 2 point grounding

PART NO.:

C707 10M006 535 2	without positioning pins
-------------------	--------------------------

C707A SIMLOCK® with Drawer



- *packaging: contact carrier in tape & reel, drawer in pallet*
- *for SIM/SAM applications*
- *designer does not have to be concerned with housing tolerances and card guiding due to self contained system*
- *card detection switch*

PART NO.:

C707 10M006 528 2 Contact Carrier

C707 10M006 529 2 Drawer (grey)

C707A SIMLOCK® basic



- *height: 3.0 mm*
- *for SIM/SAM applications*
- *designer does not have to be concerned with housing tolerances and card guiding due to self contained system*
- *locking detector as an option*

PART NO.:

C707 10M006 000 2 **with** locking detector, 4 positioning pins, packaging: tray

C707 10M006 001 2 **without** locking detector, 4 positioning pins, packaging: tray

C707 10M006 021 2 **without** locking detector, 2 positioning pins, tape & reel

C707 10M006 503 2 **with** locking detector, 2 positioning pins, tape & reel, without lid

C707 10M006 027 2 LID for SIMLOCK®, **with** locking detector

C707B SIMBLOCK®

Amphenol

C707B SIMBLOCK® 6pin



- spoon contacts for multidirectional card insertion
- packaging: tape & reel, quantity on the reel depending on the height
- other heights upon request
- for full size chip card and SIM/SAM applications

PART NO.:

C707 10M006 147 2	height: 1.05 mm
C707 10M006 148 2	height: 1.20 mm
C707 10M006 149 2	height: 1.30 mm
C707 10M006 151 2	height: 1.50 mm
C707 10M006 131 2	height: 1.80 mm
C707 10M006 119 2	height: 2.00 mm
C707 10M006 110 2	height: 2.20 mm
C707 10M006 121 2	height: 2.60 mm
C707 10M006 122 2	height: 2.80 mm
C707 10M006 124 2	height: 3.20 mm
C707 10M006 126 2	height: 3.70 mm
C707 10M006 109 2	height: 4.00 mm
C707 10M006 117 2	height: 4.60 mm
C707 10M006 130 2	height: 5.00 mm
C707 10M006 189 2	height: 5.70 mm

C707B SIMBLOCK® 8pin



- for chipcards according to ISO 7816 (full size cards)

PART NO.:

C707 10M006 052 2	height: 2.0 mm, tray packaging
C707 10M006 065 2	height: 2.0 mm, NO switch, tray packaging
C707 10M006 177 2	height: 1.2 mm, tape & reel packaging, spoon contacts for multidirectional card insertion, height: 1.05 – 1.8 mm upon request

C707D WINGBLOCK

Amphenol

C707D WINGBLOCK 6pin



- *packaging: tape & reel*
- *for SIM/SAM applications*
- *metal wings as card guidance*

PART NO.:

C707 10M006 097 2	height: 2.8 mm, with card stop
C707 10M006 115 2	height: 2.7 mm, with card stop

C707D BRIDGEBLOCK 6pin



- *packaging: tape & reel*
- *for SIM/SAM applications*
- *metal bridge as card guidance*
- *other heights upon request*

PART NO.:

C707 10M006 116 2	height: 1.6 mm, with card stop, with card presence switch, 4 positioning pins, shielded
C707 10M006 136 2	height: 2.0 mm, with card stop
C707 10M006 137 2	height: 2.2 mm, with card stop
C707 10M006 154 2	height: 2.0 mm, octagonal
C707 10M006 167 2	height: 2.8 mm, octagonal

International

Argentina

Amphenol Argentina
Av. Callao 930
2nd Floor Office B "Plaza"
C1023 AAP Buenos Aires
Phone +54 / 11 / 4815 68 86
Fax +54 / 11 / 4814 57 79

Australia

Amphenol Australia Ltd.
2 Fiveways Blvd
Keysborough
Victoria 31 73
Phone +61 / 3 / 87 96 / 88 88
Fax +61 / 3 / 87 96 / 88 01

Brasilia

Amphenol do Brasil Ltda.
Rua Diogo Moreira 132, 20th Floor
CEP 05423-010 Sao Paulo SP
Phone +55 / 11 / 3815.10 03
Fax +55 / 11 / 3815.16 29

China

Amphenol-Tuchel Electronics GmbH
China Branch
20 Tianshan Road
Changzhou 213 022
Phone +86 / 05 19 / 5 11 03 01
Fax +86 / 05 19 / 5 11 02 99

Germany

Amphenol-Tuchel Electronics GmbH
August-Haesser-Str. 10
74080 Heilbronn
Phone +49 / 71 31 / 9 29-0
Fax +49 / 71 31 / 9 29-486

Great Britain

Amphenol-Tuchel Great Britain
PO Box 6766
Basingstoke
RG24 4JG
Phone +44 / 12 56 / 33 07 49
Fax +44 / 12 56 / 33 07 49

Hong Kong

Amphenol East Asia Limited
Units 2201-02, Railway Plaza
39 Chatham Road South
Tsimshatsui, Kowloon
Phone +852 / 26 99 / 26 63
Fax +852 / 26 88 / 09 74

India

Amphetrnix Limited
Plot No. 105 Bhosari Industrial Area
Pune - 411 026
Phone +91 / 20 / 27121418
Fax +91 / 20 / 2712 05 81

Italy

Amphenol-Tuchel Italy
Via Barbaiana n. 5
I-20020 Lainate (MI)
Phone +39 / 2 / 93 25 41
Fax +39 / 2 / 93 25 44 44

Japan

Amphenol Japan, K.K.
2-3-27, Kudan Minami
Chiyoda-Ku
Tokyo 102
Phone +81 / 3 / 32 63 / 56 11
Fax +81 / 3 / 52 76 / 70 59

Korea

Amphenol DaeShin Limited
558 Songnae-Dong, Sosa-Gu
Bucheon-City, Kyunggi-Do
Korea 422-040
Phone +82 / 2 / 785 / 15 88
Fax +82 / 2 / 589 / 15 14

Mexico

Amphenol Mexico
Prolongacion Reforma 61 - 6 B2
Col. Paseo de las Lomas
C.P. 01330 Mexico D.F.
Phone +52 / 55 / 52 58.99 84
Fax +52 / 55 / 50 81.68 90

Singapore

Amphenol East Asia Limited
Asia Pacific Sales Operation
Singapore Branch
300 Beach Road
#25-07 The Concourse
Singapore 199555
Phone +27 / 11 / 305-95 74
Fax +27 / 11 / 305-95 76

South Africa

Amphenol International Ltd
Chislehurst
30 Impala Road
Chislehurst
Sandton, 2146
Phone +27 / 11 / 7 83 95 17
Fax +27 / 11 / 7 83 95 19

Spain

Amphenol-Tuchel Spain
Ctra Sabadell a Mollet,
km 4,5 Nave 5
08130 Santa Perpetua de Mogoda
(Barcelona)
Phone +34 / 93 / 5 74.41.34
Fax +34 / 93 / 5 74.10.09

Taiwan

Amphenol East Asia Ltd.
Taiwan Branch (H.K.)
116 Zhong Shan Road
Lane 956 Taoyuan City
Taiwan R.O.C. 330
Phone +886 / 3 / 370 / 78 55
Fax +886 / 3 / 360 / 72 59

Turkey

Amphenol Turkiye
Ayazaga Mah. Meydan Sk. No. 28
Beybi Giz Plaza, Kat. 26
34396 Maslak/Istanbul
Phone +90 / 0212 / 3 35 25 01
Fax +90 / 0212 / 3 35 25 00

USA

Amphenol-Tuchel Electronics
6900 Haggerty Road
Suite 200
Canton, Michigan 48187
Phone +1 / 734 / 451 64 00
Fax +1 / 734 / 451 71 97

Amphenol Corporation
Corporate Headquarters
358 Hall Avenue
Wallingford, CT 06492
Phone +1 / 800 / 380 80 52
Phone +1 / 2 03 / 2 65 / 89 00
Fax +1 / 2 03 / 2 65 / 86 28

Your engineering sales representative:

Amphenol

Amphenol-Tuchel Electronics GmbH

August-Haesser-Str. 10 · D-74080 Heilbronn · Deutschland · Phone +49 (0)71 31/9 29-0 · Fax +49 (0)71 31/9 29-486 · www.amphenol.info

Компания «Life Electronics» занимается поставками электронных компонентов импортного и отечественного производства от производителей и со складов крупных дистрибьюторов Европы, Америки и Азии.

С конца 2013 года компания активно расширяет линейку поставок компонентов по направлению коаксиальный кабель, кварцевые генераторы и конденсаторы (керамические, пленочные, электролитические), за счёт заключения дистрибьюторских договоров

Мы предлагаем:

- Конкуренеспособные цены и скидки постоянным клиентам.
- Специальные условия для постоянных клиентов.
- Подбор аналогов.
- Поставку компонентов в любых объемах, удовлетворяющих вашим потребностям.
- Приемлемые сроки поставки, возможна ускоренная поставка.
- Доставку товара в любую точку России и стран СНГ.
- Комплексную поставку.
- Работу по проектам и поставку образцов.
- Формирование склада под заказчика.
- Сертификаты соответствия на поставляемую продукцию (по желанию клиента).
- Тестирование поставляемой продукции.
- Поставку компонентов, требующих военную и космическую приемку.
- Входной контроль качества.
- Наличие сертификата ISO.

В составе нашей компании организован Конструкторский отдел, призванный помогать разработчикам, и инженерам.

Конструкторский отдел помогает осуществить:

- Регистрацию проекта у производителя компонентов.
- Техническую поддержку проекта.
- Защиту от снятия компонента с производства.
- Оценку стоимости проекта по компонентам.
- Изготовление тестовой платы монтаж и пусконаладочные работы.



Тел: +7 (812) 336 43 04 (многоканальный)
Email: org@lifeelectronics.ru