

FEATURES

- Accurate monitoring of up to four power supply voltages
- 5 factory-set threshold options: 1.8 V, 2.5 V, 3.0 V, 3.3 V, 5 V
- Adjustable input threshold voltage = 0.62 V (1.5% accuracy)
- 200 ms typical reset timeout
- Open-drain RESET output (10 μ A internal pull-up)
- Reset output stage: active low, valid to $IN_1 = 1$ V or $IN_2 = 1$ V
- Low power consumption (35 μ A)
- Power supply glitch immunity
- Specified from -40°C to $+85^{\circ}\text{C}$
- 6-lead SOT-23 package

APPLICATIONS

- Telecommunications
- Microprocessor systems
- Desktop and notebook computers
- Data storage equipment
- Servers/workstations

GENERAL DESCRIPTION

The ADM6710 is a low voltage, high accuracy supervisory circuit. The device monitors up to four system supply voltages.

The ADM6710 incorporates a variety of internally pretrimmed undervoltage threshold options for monitoring 1.8 V, 2.5 V, 3.0 V, 3.3 V and 5.0 V supply voltages. The ADM6710Q offers three adjustable thresholds for monitoring voltages down to 0.62 V. See the Ordering Guide section for a list and description of all available options.

If a monitored power supply voltage falls below the minimum voltage threshold, a single active low output asserts, triggering a system reset. The output is open drain with a weak internal pull-up to the monitored IN_2 supply (or to V_{CC} in the case of the

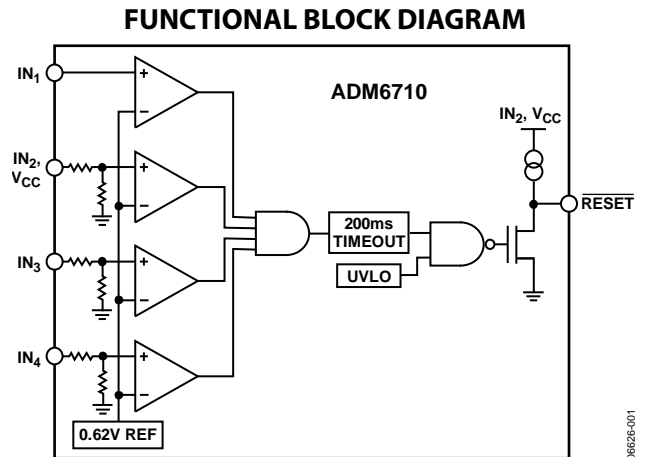

Figure 1.

ADM6710Q) of typically 10 μ A. Once all voltages rise above the selected threshold level, the reset signal remains low for the reset timeout period (200 ms typical).

The ADM6710 output remains valid as long as IN_1 or IN_2 exceeds 1 V, whereas for the ADM6710Q, the output remains valid as long as V_{CC} exceeds 2 V.

Unused monitored inputs should not be allowed to float or to be grounded, instead they should be connected to a supply voltage greater than their specified threshold voltages.

The ADM6710 is available in a 6-lead SOT-23 package. The device operates over the extended temperature range of -40°C to $+85^{\circ}\text{C}$.

Rev. A

Information furnished by Analog Devices is believed to be accurate and reliable. However, no responsibility is assumed by Analog Devices for its use, nor for any infringements of patents or other rights of third parties that may result from its use. Specifications subject to change without notice. No license is granted by implication or otherwise under any patent or patent rights of Analog Devices. Trademarks and registered trademarks are the property of their respective owners.

TABLE OF CONTENTS

Features	1	Typical Performance Characteristics	6
Applications.....	1	Theory of Operation	8
Functional Block Diagram	1	Input Configuration.....	8
General Description	1	$\overline{\text{RESET}}$ Output Configuration	8
Revision History	2	Addition Of Manual Reset	8
Specifications.....	3	Outline Dimensions	9
Absolute Maximum Ratings.....	4	Ordering Guide	9
ESD Caution.....	4		
Pin Configurations and Function Descriptions	5		

REVISION HISTORY

10/10—Rev. 0 to Rev. A

Added Figure 17..... 9

6/07—Revision 0: Initial Version

SPECIFICATIONS

$V_{IN2} = 1\text{ V to }5.5\text{ V}$, $T_A = -40^\circ\text{C to }+85^\circ\text{C}$, unless otherwise noted. Typical values are $V_{IN2} = 3.0\text{ V to }3.3\text{ V}$, $T_A = 25^\circ\text{C}$.

Table 1.

Parameter	Min	Typ	Max	Units	Test Conditions/Comments
OPERATING VOLTAGE RANGE					
V_{CC}^1	2.0		5.5	V	ADM6710Q only
V_{IN2}^2	1.0		5.5	V	All devices except ADM6710Q; $T_A = 0^\circ\text{C to }+85^\circ\text{C}$
	1.2		5.5	V	All devices except ADM6710Q; $T_A = -40^\circ\text{C to }+85^\circ\text{C}$
INPUT CURRENT					
IN_x Input Current		25	40	μA	IN_x = nominal input voltage (for 1.8 V, 2.5 V and 5.0 V supplies)
		55	115	μA	IN_2 = nominal input voltage (for 3.0 V and 3.3 V supplies); the supply splits into 25 μA for the resistor divider and 30 μA for other circuits
			0.4	μA	$V_{IN1} = 0\text{ V to }0.85\text{ V}$ (for adjustable thresholds)
			0.2	μA	$V_{IN3}, V_{IN4} = 0\text{ V to }0.85\text{ V}$ (for adjustable thresholds)
I_{CC} Input Current		35	50	μA	ADM6710Q only; $V_{CC} = 5.5\text{ V}$
THRESHOLD VOLTAGE					
Threshold Voltage (V_{TH})	4.50	4.63	4.75	V	IN_x decreasing; 5 V (–5%)
	4.25	4.38	4.50	V	IN_x decreasing; 5 V (–10%)
	3.00	3.08	3.15	V	IN_x decreasing; 3.3 V (–5%)
	2.85	2.93	3.00	V	IN_x decreasing; 3.3 V (–10%)
	2.70	2.78	2.85	V	IN_x decreasing; 3.0 V (–5%)
	2.55	2.63	2.70	V	IN_x decreasing; 3.0 V (–10%)
	2.25	2.32	2.38	V	IN_x decreasing; 2.5 V (–5%)
	2.13	2.19	2.25	V	IN_x decreasing; 2.5 V (–10%)
	1.62	1.67	1.71	V	IN_x decreasing; 1.8 V (–5%)
	1.53	1.58	1.62	V	IN_x decreasing; 1.8 V (–10%)
Adjustable Threshold (V_{TH})	0.611	0.620	0.629	V	IN_x decreasing
RESET THRESHOLD HYSTERESIS (V_{HYST})		0.3		$\%V_{TH}$	IN_x increasing relative to IN_x decreasing
RESET THRESHOLD TEMPERATURE COEFFICIENT (TCV_{TH})		60		ppm/ $^\circ\text{C}$	
IN_x to RESET DELAY (t_{RP})		30		μs	V_{IN} falling at 10 mV/ μs from V_{TH} to $V_{TH} - 50\text{ mV}$
RESET TIMEOUT PERIOD (t_{RP})	140	200	280	ms	
RESET OUTPUT LOW (V_{OL})			0.3	V	$V_{IN2}, V_{CC} = 5\text{ V}, I_{SINK} = 2\text{ mA}$
			0.4	V	$V_{IN2}, V_{CC} = 2.5\text{ V}, I_{SINK} = 1.2\text{ mA}$
			0.3	V	$V_{IN2} = 1.0, I_{SINK} = 20\text{ }\mu\text{A}, T_A = 0^\circ\text{C to }+85^\circ\text{C}$
RESET OUTPUT HIGH (V_{OH})	$0.8 \times V_{CC}$			V	$V_{CC} \geq 2.0\text{ V}, I_{SOURCE} = 4\text{ }\mu\text{A}, \overline{\text{RESET}}$ deasserted (ADM6710Q only)
	$0.8 \times V_{IN2}$			V	$V_{IN2} \geq 2.0\text{ V}, I_{SOURCE} = 4\text{ }\mu\text{A}, \overline{\text{RESET}}$ deasserted
RESET OUTPUT HIGH SOURCE CURRENT (I_{OH})		10		μA	$V_{IN2} \geq 2.0\text{ V}, \overline{\text{RESET}}$ deasserted

¹ Note that the ADM6710Q is powered from V_{CC} .

² The RESET output is guaranteed to be in the correct state for IN_1 or IN_2 down to 1 V.

ADM6710

ABSOLUTE MAXIMUM RATINGS

Table 2.

Parameter	Rating
V_{CC} , IN_x , \overline{RESET} to GND	-0.3 V to +6 V
Continuous \overline{RESET} Current	20 mA
Storage Temperature Range	-65°C to +125°C
Operating Temperature Range	-40°C to +85°C
Lead Temperature (10 sec)	300°C
Junction Temperature	135°C

Stresses above those listed under Absolute Maximum Ratings may cause permanent damage to the device. This is a stress rating only; functional operation of the device at these or any other conditions above those indicated in the operational section of this specification is not implied. Exposure to absolute maximum rating conditions for extended periods may affect device reliability.

Table 3. Thermal Resistance

Package Type	θ_{JA}	Unit
6-lead SOT-23	169.5	°C/W

ESD CAUTION



ESD (electrostatic discharge) sensitive device. Charged devices and circuit boards can discharge without detection. Although this product features patented or proprietary protection circuitry, damage may occur on devices subjected to high energy ESD. Therefore, proper ESD precautions should be taken to avoid performance degradation or loss of functionality.

PIN CONFIGURATIONS AND FUNCTION DESCRIPTIONS

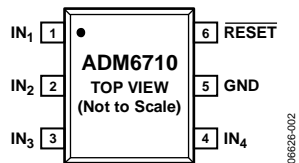

Figure 2. ADM6710 Pin Configuration

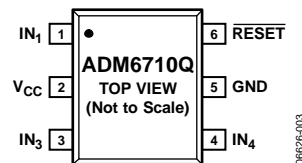

Figure 3. ADM6710Q Pin Configuration

Table 4. Pin Function Descriptions

Pin No.	Mnemonic	Description
1	IN ₁	Input Voltage 1.
2	IN ₂	Input Voltage 2. IN ₂ is the power supply input for the ADM6710.
	V _{CC}	V _{CC} is the power supply input for the ADM6710Q. It is not a monitored input.
3	IN ₃	Input Voltage 3.
4	IN ₄	Input Voltage 4.
5	GND	Ground.
6	RESET	Active Low $\overline{\text{RESET}}$ Output. $\overline{\text{RESET}}$ goes low when an input drops below the specified threshold. Once all inputs rise above the threshold voltage, $\overline{\text{RESET}}$ remains low for 200 ms (typical) before going high. $\overline{\text{RESET}}$ is open drain with a weak internal pull-up to IN ₂ or, in the case of the ADM6710Q, to V _{CC} , typically 10 μA .

TYPICAL PERFORMANCE CHARACTERISTICS

$V_{IN2} = V_{CC} = 3.0V$, $T_A = 25^\circ C$, unless otherwise noted.

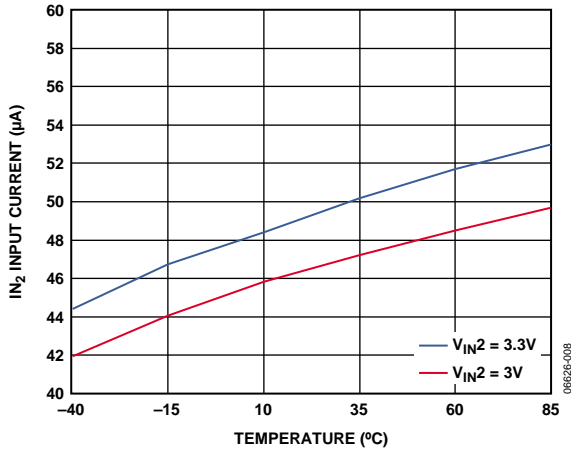

Figure 4. IN₂ Input Current vs. Temperature

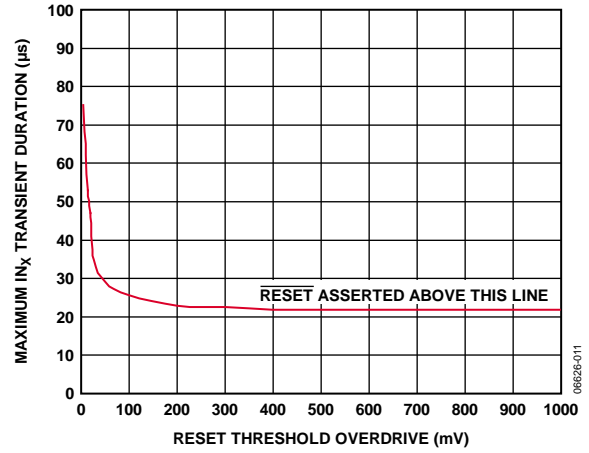

Figure 7. Maximum IN_x Transient Duration vs. Reset Threshold Overdrive

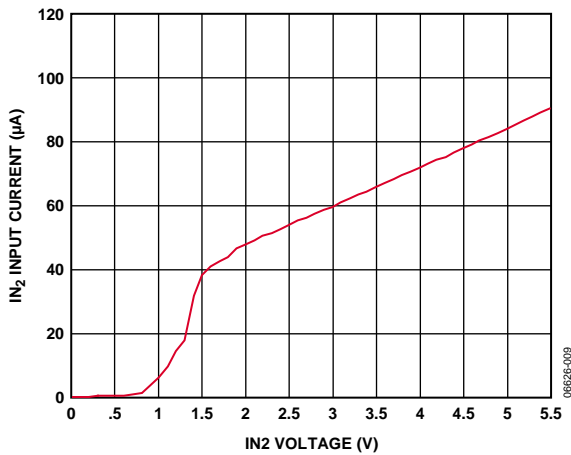

Figure 5. IN₂ Input Current vs. IN₂ Voltage

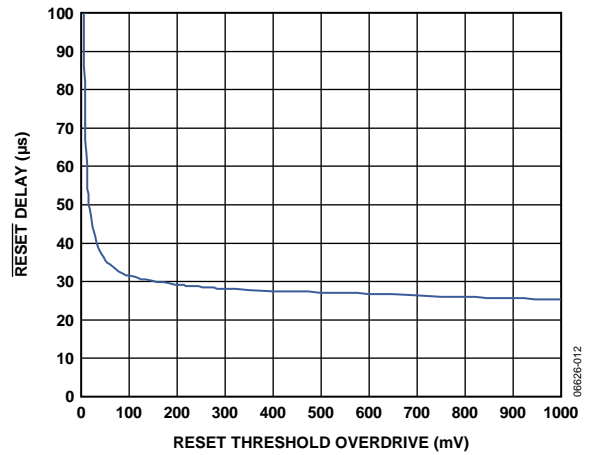

Figure 8. RESET Delay vs. Reset Threshold Overdrive (IN_x Decreasing)

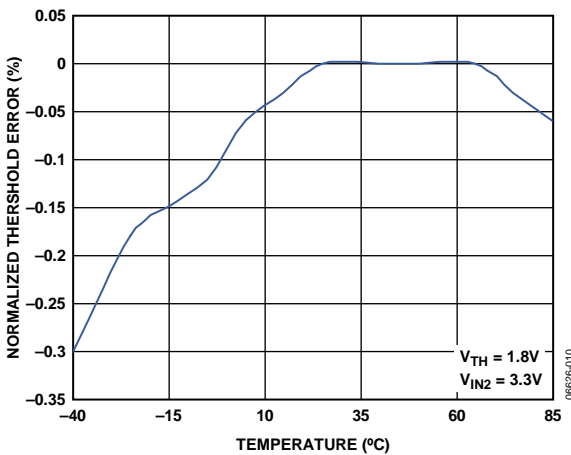

Figure 6. Normalized Threshold Error vs. Temperature

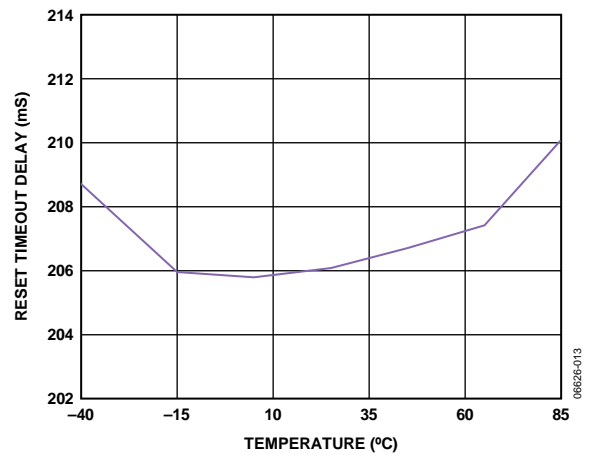

Figure 9. Reset Timeout Delay vs. Temperature

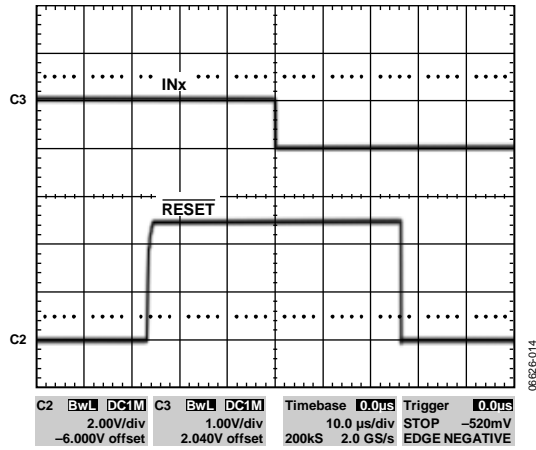

Figure 10. RESET Pull-Up and Pull-Down Response (10 µs/div)

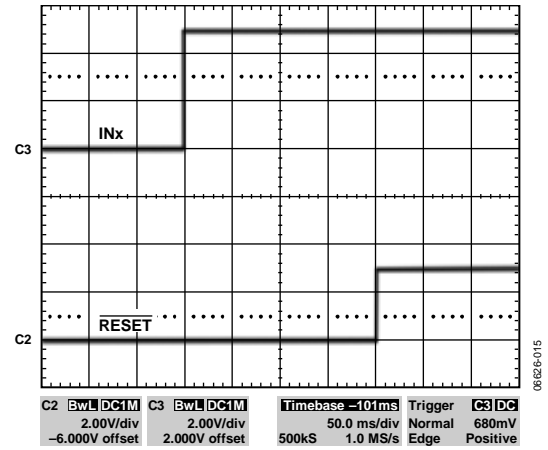

Figure 11. RESET Timeout Delay (50 ms/div)

THEORY OF OPERATION

The ADM6710 is a compact, low power supervisory circuit capable of monitoring up to four voltages in a multisupply application.

The device includes several factory-set voltage threshold options for monitoring 1.8 V, 2.5 V, 3.0 V, 3.3 V and 5.0 V supplies. It also provides up to three adjustable thresholds for monitoring voltages down to 0.62 V. See the Ordering Guide section for a list and description of all available options.

The ADM6710Q has three adjustable voltage inputs and is powered by V_{CC} , which is not a monitored voltage. All other ADM6710 devices are powered by IN_2 , which is a monitored voltage, and therefore monitors up to four voltages. If a monitored voltage drops below its associated threshold, the active low reset output asserts low and remains low while either IN_1 or IN_2 remains above 1.0 V.

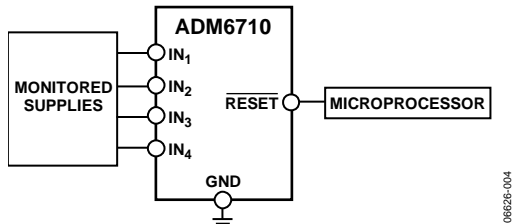

Figure 12. Typical Applications Circuit

INPUT CONFIGURATION

The ADM6710 provides numerous monitor choices with adjustable reset thresholds. Typically, the threshold voltage at each adjustable IN_x input is 0.62 V. To monitor a voltage greater than 0.62 V, connect a resistor divider network to the circuit as depicted in Figure 13, where

$$V_{INTH} = 0.62 V \left(\frac{R_1 + R_2}{R_2} \right)$$

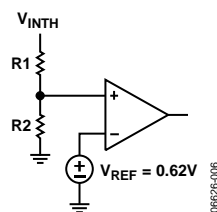

Figure 13. Setting the Adjustable Monitor

The internal comparators each typically have a hysteresis of 0.3% with respect to the reset threshold. This built-in hysteresis improves the device's immunity to ambient noise without noticeably reducing the threshold accuracy. The ADM6710 is unaffected by short input transients.

The ADM6710 is powered from the monitored IN_2 , or V_{CC} in the case of the ADM6710Q. Monitored inputs are resistant to short power supply glitches. Figure 7 depicts the ADM6710 glitch immunity data. To increase noise immunity in noisy applications, place a 0.1 μ F capacitor between the IN_2 input and ground.

Adding capacitance to IN_1 , IN_3 , and IN_4 also improves noise immunity.

Do not allow unused monitor inputs to float or to be grounded. Connect these inputs to a supply voltage greater than their specified threshold voltages. In the case of unused IN_x adjustable inputs, limit the bias current by connecting a 1 M Ω series resistor between the unused input and IN_2 (or V_{CC} in the case of the ADM6710Q).

RESET OUTPUT CONFIGURATION

The \overline{RESET} output asserts low if a monitored IN_x voltage drops below its voltage threshold. Once all voltages rise above the selected threshold level, the reset signal remains low for the reset timeout period (200 ms typical). The reset output is open drain with a weak internal pull-up to the monitored IN_2 or V_{CC} supply, typically 10 μ A.

Many applications that interface with other logic devices do not require an external pull-up resistor. However, if an external pull-up resistor is required and it is connected to a voltage ranging from 0 V to 5.5 V, it will overdrive the internal pull-up. Reverse current flow from the external pull-up voltage to IN_2 is prevented by the internal circuitry.

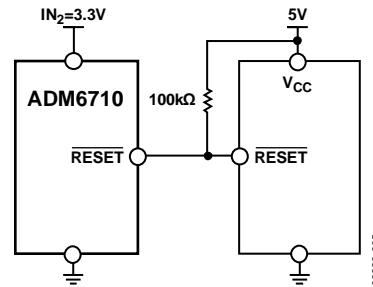

Figure 14. Interface with a Different Logic Supply Voltage

ADDITION OF MANUAL RESET

Use the circuit shown in Figure 15 to add manual reset to any of the ADM6710 adjustable inputs. When the switch is closed, the analog input shorts to ground and a \overline{RESET} output commences. The switch must remain open for a minimum of 140 ms for the \overline{RESET} output to deassert.

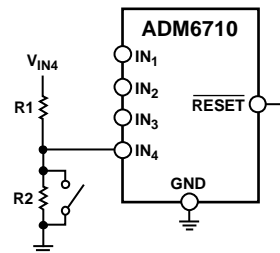
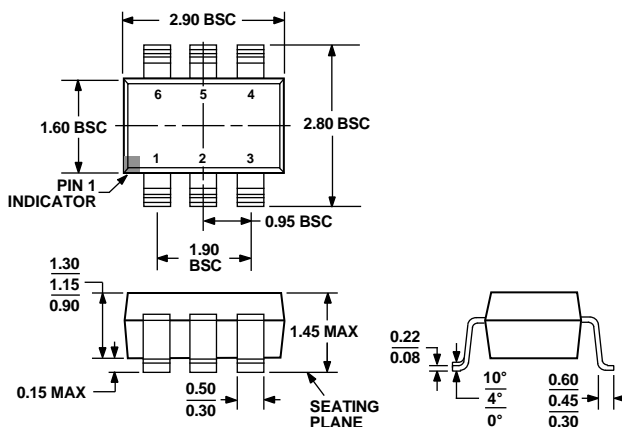

Figure 15. Addition of Manual Reset (IN_4 is an Adjustable Input)

OUTLINE DIMENSIONS



COMPLIANT TO JEDEC STANDARDS MO-178-AB

Figure 16. 6-Lead Small Outline Transistor Package [SOT-23] (RJ-6)

Dimensions shown in millimeters

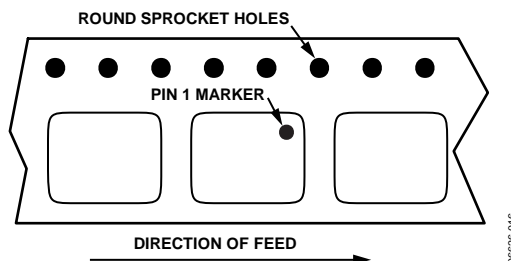

Figure 17. ADM6710 Reel Orientation

ORDERING GUIDE

Model ^{1, 2}	Nominal Input Voltage				Supply Tolerance (%)	Temperature Range	Package Description	Package Option	Branding
	IN ₁	IN ₂	IN ₃	IN ₄					
ADM6710AARJZ-REEL7	5	3.3	2.5	Adj.	10	-40°C to +85°C	6-Lead SOT-23	RJ-6	MA9
ADM6710BARJZ-REEL7	5	3.3	2.5	Adj.	5	-40°C to +85°C	6-Lead SOT-23	RJ-6	MAH
ADM6710CARJZ-REEL7	5	3.3	1.8	Adj.	10	-40°C to +85°C	6-Lead SOT-23	RJ-6	MAJ
ADM6710DARJZ-REEL7	5	3.3	1.8	Adj.	5	-40°C to +85°C	6-Lead SOT-23	RJ-6	MAK
ADM6710EARJZ-REEL7	Adj.	3.3	2.5	1.8	10	-40°C to +85°C	6-Lead SOT-23	RJ-6	MAX
ADM6710FARJZ-REEL7	Adj.	3.3	2.5	1.8	5	-40°C to +85°C	6-Lead SOT-23	RJ-6	MA4
ADM6710GARJZ-REEL7	5	3.3	Adj.	Adj.	10	-40°C to +85°C	6-Lead SOT-23	RJ-6	MAL
ADM6710HARJZ-REEL7	5	3.3	Adj.	Adj.	5	-40°C to +85°C	6-Lead SOT-23	RJ-6	MAM
ADM6710IARJZ-REEL7	Adj.	3.3	2.5	Adj.	10	-40°C to +85°C	6-Lead SOT-23	RJ-6	MAN
ADM6710JARJZ-REEL7	Adj.	3.3	2.5	Adj.	5	-40°C to +85°C	6-Lead SOT-23	RJ-6	MAP
ADM6710KARJZ-REEL7	Adj.	3.3	1.8	Adj.	10	-40°C to +85°C	6-Lead SOT-23	RJ-6	MAQ
ADM6710LARJZ-REEL7	Adj.	3.3	1.8	Adj.	5	-40°C to +85°C	6-Lead SOT-23	RJ-6	MAR
ADM6710MARJZ-REEL7	Adj.	3	2.5	Adj.	10	-40°C to +85°C	6-Lead SOT-23	RJ-6	MAS
ADM6710NARJZ-REEL7	Adj.	3	2.5	Adj.	5	-40°C to +85°C	6-Lead SOT-23	RJ-6	MAT
ADM6710OARJZ-REEL7	Adj.	3	1.8	Adj.	10	-40°C to +85°C	6-Lead SOT-23	RJ-6	MAU
ADM6710PARJZ-REEL7	Adj.	3	1.8	Adj.	5	-40°C to +85°C	6-Lead SOT-23	RJ-6	MAV
ADM6710QARJZ-REEL7	Adj.	V _{CC}	Adj.	Adj.	Not applicable	-40°C to +85°C	6-Lead SOT-23	RJ-6	MAW

¹ Z = RoHS Compliant Part.

² Adjustable voltage based on 0.62 V internal threshold. The external threshold voltage can be set using an external resistor divider.

NOTES

NOTES

ADM6710

NOTES

Компания «Life Electronics» занимается поставками электронных компонентов импортного и отечественного производства от производителей и со складов крупных дистрибьюторов Европы, Америки и Азии.

С конца 2013 года компания активно расширяет линейку поставок компонентов по направлению коаксиальный кабель, кварцевые генераторы и конденсаторы (керамические, пленочные, электролитические), за счёт заключения дистрибьюторских договоров

Мы предлагаем:

- Конкурентоспособные цены и скидки постоянным клиентам.
- Специальные условия для постоянных клиентов.
- Подбор аналогов.
- Поставку компонентов в любых объемах, удовлетворяющих вашим потребностям.
- Приемлемые сроки поставки, возможна ускоренная поставка.
- Доставку товара в любую точку России и стран СНГ.
- Комплексную поставку.
- Работу по проектам и поставку образцов.
- Формирование склада под заказчика.
- Сертификаты соответствия на поставляемую продукцию (по желанию клиента).
- Тестирование поставляемой продукции.
- Поставку компонентов, требующих военную и космическую приемку.
- Входной контроль качества.
- Наличие сертификата ISO.

В составе нашей компании организован Конструкторский отдел, призванный помогать разработчикам, и инженерам.

Конструкторский отдел помогает осуществить:

- Регистрацию проекта у производителя компонентов.
- Техническую поддержку проекта.
- Защиту от снятия компонента с производства.
- Оценку стоимости проекта по компонентам.
- Изготовление тестовой платы монтаж и пусконаладочные работы.



Тел: +7 (812) 336 43 04 (многоканальный)

Email: org@lifeelectronics.ru