

HD-20 Straight Posted Connectors





Product Selection Guide

Connector Density	Type	Post Style	Style and Shell Finish	No. of Contact Positions	Mating Hardware	Contact Plating (Mating Area/Solder Tails)	Post Length	Profile	
HD-20	Plugs and Receptacles	Straight	Full Metal-Shell With and Without Grounding Indents, Tin Plated (pgs. 78 and 79)	9	.120 [3.05] Dia. Holes	Duplex (.000030 [0.00076] Gold/Tin)	.125 [3.18]	High	
				15	Clinch Nuts	Duplex (.000030 [0.00076] Gold/Tin)	.188 [4.78]		
				25					
				37					
				50					
				9	Threaded Inserts	Duplex (.000030 [0.00076] Gold/Tin)	.125 [3.18]		Medium
	15	Retention Inserts	Duplex (Gold Flash/Tin)	.170 [4.32]					
	37	Female Screwlocks	Duplex (Gold Flash/Tin)	.250 [6.35]					
	All-Plastic (pgs. 82-85)				9	.120 [3.05] Dia. Holes	Duplex (.000030 [0.00076] Gold/Tin)	.125 [3.18]	Medium
					15	Threaded Inserts	Duplex (Gold Flash/Tin)	.170 [4.32]	
					25				
					37				
50									
ACTION PIN					Plugs and Receptacles	Straight	Front Metal-Shell Tin Plated (pgs. 87 and 88)	9	
	15	Threaded Inserts	Duplex (Gold/Tin)						
	25								
	37	Female Screwlocks	Duplex (Gold/Tin)						
	Receptacles			All-Plastic (pg. 89)	9	.120 [3.05] Dia. Holes	Duplex (.000030 [0.00076] Gold Flash/Tin)	.228 [5.79]	Low/High
					15	Threaded Inserts	Duplex (.000010 [0.000254] Gold Flash/Tin)		
25									
37	Female Screwlocks	Duplex (Gold Flash/Tin)							
HD-22	Plugs and Receptacles	Straight	Front Metal-Shell With Grounding Indents, Nickel Plated (pg. 86)	15	.120 [3.05] Dia. Holes	Duplex (.000030 [0.00076] Gold/Tin)	.125 [3.18]	Medium	
				26	Threaded Inserts	Duplex (.000015 [0.00038] Gold/Tin)			
				44					
				62					
				78					
					Female Screwlocks	Duplex (Gold Flash/Tin)			

HD-20 Straight Posted Connectors (Continued)

Product Facts

- Flame retardant thermo-plastic housing material, UL 94V-0 rated
- HD-20 straight posted connectors are available in 9, 15, 25, 37 and 50 positions (Shell Sizes 1 thru 5)
- HD-20 straight posted connectors in Full Metal-Shell, Front Metal-Shell and All-Plastic versions
- HD-20 connectors with ACTION PIN contacts are available in low, medium and high profiles with integral standoffs
- ACTION PIN contact connectors for both .093 [2.36] and .062 [1.58] min. thick pc board application
- Various straight posted connectors offer a choice of through-holes, 4-40 threaded inserts or 4-40 fixed female screwlocks
- Choice of contact platings
- Integral boardlock feature secures connector to pc board prior to soldering
- Connectors are intermateable with any size 20 or 22 subminiature D connectors dimensionally complying with MIL-C-24308
- Recognized under the Component Program of Underwriters Laboratories Inc., File No. E28476 
- CSA Certified, File No. LR 16455 HD-20 Products 

Section Contents

Straight Posted Connectors	
HD-20 Full Metal-Shell	
Straight Posted Connectors	78, 79
HD-20 Front Metal-Shell	
Straight Posted Connectors	80, 81
HD-20 All-Plastic Straight Posted Connectors	82-85
HD-22 Subminiature D Connectors	86
HD-20 Front Metal-Shell Straight Posted	
Connectors with ACTION PIN Contacts	87, 88
HD-20 All-Plastic Straight Posted Connectors	
with ACTION PIN Contacts	89

HD-20 Full Metal-Shell Straight Posted Connectors

Plug



Without Grounding Indents



With Grounding Indents

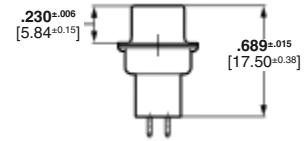
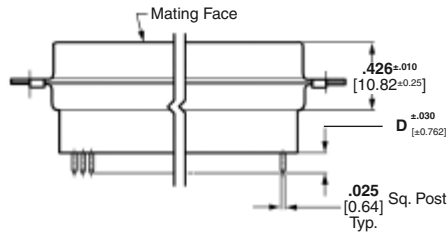
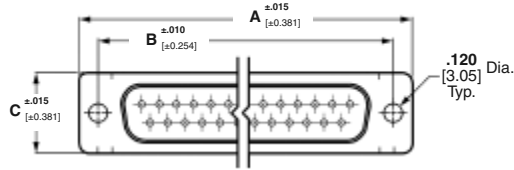

See customer drawings for pcb layouts.

Material and Finish:

Shell—Steel, tin plated
Insert—94V-0 rated thermoplastic, black

Pin Contacts (Posted)—Brass, plated as follows:
A—.000030 [0.00076] gold on mating end, tin on termination end, with entire contact .000050 [0.00127] (min.) nickel underplated
B—Gold flash on mating end, tin on termination end, with entire contact .000050 [0.00127] (min.) nickel underplated

Technical Documents:

Product Specification—108-40025

Shell Size	No. of Contact Positions	Dimensions				Contact Finish (Plating Code)	Plug Part Numbers		
		A	B	C	D*		Without Grounding Indents	With Grounding Indents	With Clinch Nuts
1	9	1.213 30.81	.984 24.99	.494 12.55	.125 3.18	A	—	5745410-1	5749014-1
					.188 4.78	B	5745182-2	—	
2	15	1.541 39.14	1.312 33.33	.494 12.55	.125 3.18	A	—	5745411-1	—
					.188 4.78	B	5745186-2	—	
3	25	2.088 53.04	1.852 47.04	.494 12.55	.125 3.18	A	—	5745412-1	5745959-1
					.188 4.78	A	—	5745412-7	—
4	37	2.729 69.32	2.500 63.50	.494 12.55	.125 3.18	A	—	5745413-1	—
					.188 4.78	A	—	5745414-1	—
5	50	2.635 66.93	2.406 61.11	.605 15.37	.125 3.18	A	—	5745414-1	—
					.188 4.78	A	—	5745414-7	—

*.125 [3.18] post length is for recommended pc board thickness of .062-.093 [1.58-2.36] max.; .188 [4.78] post length is for recommended pc board thickness of .125 [3.18].

- Notes:**
- All plugs are preloaded with size 20 DF posted pin contacts.
 - Special loading of contacts can be arranged upon request.
 - Longer post lengths available, consult TE.

Note: All part numbers are RoHS compliant.

HD-20 Full Metal-Shell Straight Posted Connectors (Continued)

Receptacle



With Clinch Nuts

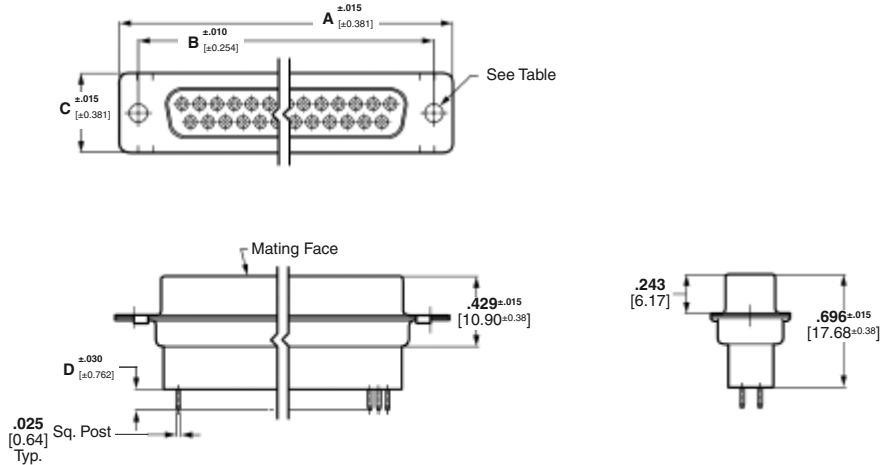

See customer drawings for pcb layouts.

Material and Finish:

- Shell**—Steel, tin plated
- Insert**—94V-0 rated thermoplastic, black
- Clinch Nuts**—Steel, zinc plated
- Socket Contacts (Posted)**—Phosphor bronze, plated as follows:
 - A**—.000030 [0.00076] gold on mating end, tin on termination end, with entire contact .000050 [0.00127] (min.) nickel underplated
 - B**—Gold flash on mating end, tin on termination end, with entire contact .000050 [0.00127] (min.) nickel underplated

Technical Documents:

Product Specification—108-40025

Shell Size	No. of Contact Positions	Dimensions				Contact Finish (Plating Code)	Receptacle Part Numbers	
		A	B	C	D*		With .120 [3.05] Mounting Holes	With Clinch Nuts
1	9	1.213 30.81	.984 24.99	.494 12.55	.125 3.18	A	5745183-1	5747190-2
					.188 4.78	B	5745183-2	5747190-1
					.188 4.78	A	5745183-7	5747190-4
					.188 4.78	B	—	—
2	15	1.541 39.14	1.312 33.33	.494 12.55	.125 3.18	A	5745185-1	5745820-1
					.188 4.78	B	—	5745820-2
					.125 3.18	A	5745185-7	—
					.188 4.78	B	—	—
3	25	2.088 53.04	1.852 47.04	.494 12.55	.125 3.18	A	5745187-1	5745886-1
					.188 4.78	B	—	5745886-2
					.125 3.18	A	5745187-7	—
					.188 4.78	B	5745187-8	—
4	37	2.729 69.32	2.500 63.50	.494 12.55	.125 3.18	A	5745189-1	5747315-1
					.188 4.78	A	5745189-7	—
					.125 3.18	A	5745191-1	5747302-1
					.188 4.78	A	5745191-7	—

*.125 [3.18] post length is for recommended pc board thickness of .062-.093 [1.58-2.36] max.; .188 [4.78] post length is for recommended pc board thickness of .093-.125 [2.36-3.18].

- Notes:**
1. All receptacles are preloaded with size 20 DF posted socket contacts.
 2. Special loading of contacts can be arranged upon request.
 3. Longer post lengths available, consult TE.

Note: All part numbers are RoHS compliant.

HD-20 Front Metal-Shell Straight Posted Connectors

Plug



With Grounding Indents



With Threaded Insert



With Fixed Female Screwlock



With Retention

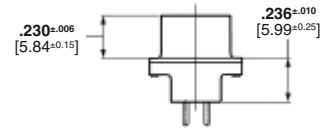
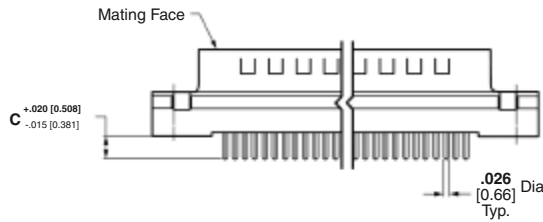
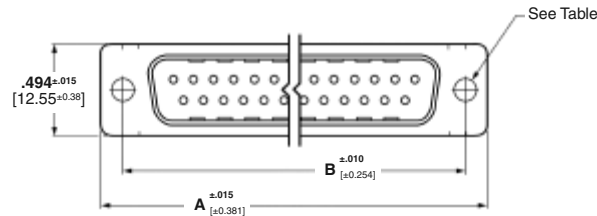

See customer drawings for pcb layouts.

Material and Finish:

Shell—Steel, tin plated

Housing—94V-0 rated thermoplastic, black

Threaded Inserts—Brass, unplated

Female Screwlocks—Zinc

Pin Contacts (Posted)—Brass, plated as follows:

A—.000030 [0.00076] gold on mating end, tin on termination end, with entire contact .000050 [0.00127] (min.) nickel underplated

B—Gold flash on mating end, tin on termination end, with entire contact .000050 [0.00127] (min.) nickel underplated

Technical Documents:

Product Specification—108-40025

Application Specification—114-40023

Shell Size	No. of Contact Positions	Dimensions			Contact Finish (Plating Code)	Plug Part Numbers				
		A	B	C*		With Standard Mounting Holes	With 4-40 Threaded Inserts	With Retention 4-40 Inserts (for .062 [1.58] PCB)	With Fixed Female Screwlocks	With Retention 4-40 Screwlocks (for .062 [1.58] PCB)
1	9	1.213 30.81	.984 24.99	.125 3.18	A	5747871-2	5747871-8	2-5748003-0	1-5747871-4	—
				—	—	—	1-5747871-3	—		
				.170 4.32	A	5747871-4	—	—	1-5747871-6	—
2	15	1.541 39.14	1.312 33.33	.125 3.18	A	—	5747872-8	—	—	5748026-1
				—	—	—	—	—		
				.170 4.32	A	5747872-4	—	—	1-5747872-6	—
3	25	2.090 53.09	1.852 47.04	.125 3.18	A	5745968-2	5745968-8	2-5747704-0	1-5745968-4	5748027-1
				—	—	5745968-7	—	1-5745968-3	—	
				.170 4.32	A	5745968-4	—	—	1-5745968-6	—
4	37	2.732 69.39	2.500 63.50	.125 3.18	A	5747375-2	5747375-8	—	—	5787686-1
				—	—	—	—	—		
				—	—	—	—	—		

*.125 [3.18] post length is recommended for pc board thickness of .062-.093 [1.58-2.36] max.; .170 [4.32] post length is recommended for pc board thickness of .093-.125 [2.36-3.18]; .250 [6.35] post length is for special applications

- Notes:**
- All plugs are preloaded with size 20 DF posted pin contacts.
 - Male screw retainers are used as mating hardware for connectors with 4-40 female screwlocks.
 - PC board hole size is .121±.002 [3.07±0.0508] for all retention inserts and screwlocks.

Note: All part numbers are RoHS compliant.

HD-20 Front Metal-Shell Straight Posted Connectors (Continued)

Receptacle



With Standard Mounting Holes



With Threaded Insert



With Fixed Female Screwlock



With Retention

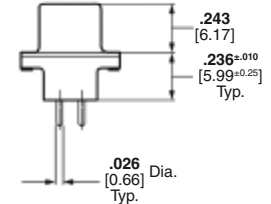
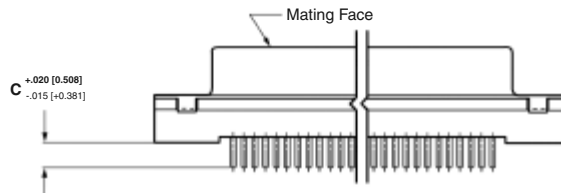
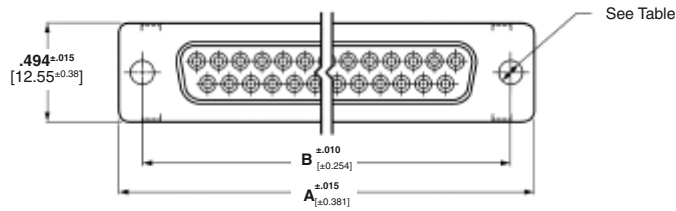

See customer drawings for pcb layouts.

Material and Finish:

- Shell**—Steel, tin plated
- Housing**—94V-0 rated thermoplastic, black
- Threaded Inserts**—Brass, unplated
- Female Screwlocks**—Zinc

- Socket Contacts (Posted)**—Phosphor bronze, plated as follows:
A—.000030 [0.00076] gold on mating end, tin on termination end, with entire contact .000050 [0.00127] (min.) nickel underplated
B—Gold flash on mating end, tin on termination end, with entire contact .000050 [0.00127] (min.) nickel underplated

- Technical Documents:**
Product Specification—108-40025
Application Specification—114-40023

Shell Size	No. of Contact Positions	Dimensions			Contact Finish (Plating Code)	Receptacle Part Numbers				
		A	B	C*		With Standard Mounting Holes	With 4-40 Threaded Inserts	With Retention 4-40 Inserts (for .062 [1.58] PCB)	With Fixed Female Screwlocks	With Retention 4-40 Screwlocks (for .062 [1.58] PCB)
1	9	1.216 30.89	.984 24.99	.125 3.18	A	5747150-2	5747150-8	2-5747706-0	1-5747150-4	5750678-1
				.170 4.32	B	—	5747150-7	—	1-5747150-3	—
				.125 3.18	A	5747299-2	5747299-8	2-5747707-0	1-5747299-4	5787683-1
				.170 4.32	B	—	5747299-7	—	1-5747299-6	—
2	15	1.541 39.14	1.312 33.33	.125 3.18	A	5745967-2	5745967-8	2-5747708-0	1-5745967-4	5748612-1
				.170 4.32	B	—	5745967-7	1-5745967-0	—	—
				.125 3.18	A	5747301-2	5747301-8	2-5747709-0	1-5747301-4	5787685-1
				.170 4.32	B	—	5747301-7	—	—	—
3	25	2.090 53.09	1.852 47.04	.125 3.18	A	—	—	—	1-5747301-6	—
				.170 4.32	B	—	—	—	—	—

*.125 [3.18] post length is recommended for pc board thickness of .062-.093 [1.58-2.36] max.; .170 [4.32] post length is recommended for pc board thickness of .093-.125 [2.36-3.18]; .250 [6.35] post length is for special applications

- Notes:**
- All receptacles are preloaded with size 20 DF posted socket contacts.
 - Male screw retainers are used as mating hardware for connectors with 4-40 female screwlocks.
 - Pc board hole size is .121±.002 [3.07±0.0508] for all retention inserts and screwlocks.

Note: All part numbers are RoHS compliant.

HD-20 All-Plastic Straight Posted Connectors

Plug



With Standard Mounting Hole



With Threaded Insert



With Fixed Female Screwlock

Straight Posted Connectors

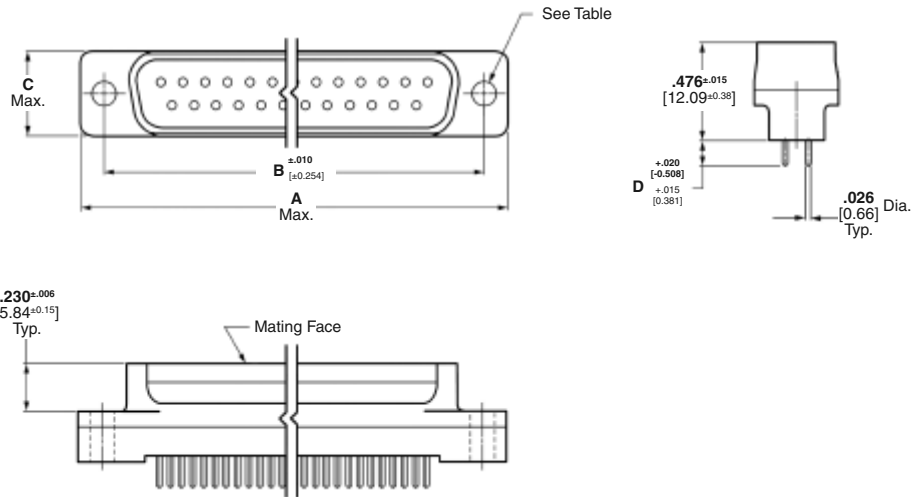

Material and Finish:

Housing—94V-0 rated thermoplastic, black

Threaded Inserts—Brass, unplated

Female Screwlocks—Brass, nickel plated

Pin Contacts (Posted)—Brass, plated as follows:

A—.000030 [0.00076] gold on mating end, tin on termination end, with entire contact .000050 [0.00127] (min.) nickel underplated

B—Gold flash on mating end, tin on termination end, with entire contact .000050 [0.00127] (min.) nickel underplated

See customer drawings for pcb layouts.

Typical Applications

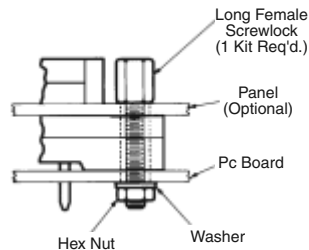

Application of connector with standard mounting holes using Long Female Screwlock Kit No. 207719

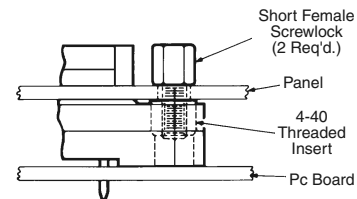

Application of connector with 4-40 Threaded Inserts using Short Female Screwlocks included in Kit No. 207952

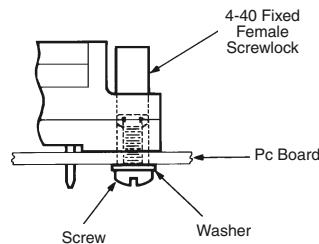

Application of connector with 4-40 Fixed Female Screwlocks. (See table on next page.)

Note: Hardware parts in illustrations above are not included with the connectors listed in the table on page 83. They are to be supplied by the Customer or, where applicable, purchased separately from TE using the part nos. specified.

Note: All part numbers are RoHS compliant.

HD-20 All-Plastic Straight Posted Connectors (Continued)

Plug
(Continued)

Shell Size	No. of Contact Positions	Dimensions				Contact Finish (Plating Code)	Plug Part Numbers		
		A	B	C	D*		With .120 [3.05] Mounting Holes	With Threaded Inserts	With Fixed Female Screwlocks
1	9	1.228 32.72	.984 24.99	.420 10.67	.125 3.18	A	5208006-2	5745051-2	5745071-2
					.170 4.32	B	5208006-1	5745051-1	5745071-1
2	15	1.546 39.27	1.312 33.33	.420 10.67	.125 3.18	A	5208007-2	5745052-2	5745072-2
					.170 4.32	B	—	5745052-1	—
					.170 4.32	A	—	—	5745072-4
3	25	2.095 53.21	1.852 47.04	.420 10.67	.125 3.18	A	5208008-2	5745053-2	5745073-2
					.170 4.32	B	5208008-1	—	5745073-1
4	37	2.737 69.52	2.500 63.50	.420 10.67	.125 3.18	A	—	—	5745074-2
					.170 4.32	B	5208009-1	—	5745074-1
					.170 4.32	A	—	5745054-4	5745074-4
5	50	2.643 67.13	2.406 61.11	.527 13.39	.125 3.18	A	5208010-2	—	—
					.170 4.32	B	5208009-3	—	—

*.125 [3.18] post length is recommended for pc board thickness of .062-.093 [1.58-2.36] max.; .170 [4.32] post length is recommended for pc board thickness of .093-.125 [2.36-3.18]; .250 [6.35] post length is for special applications.

- Notes:**
1. All plugs are preloaded with size 20 DF posted pin contacts.
 2. It is recommended that these connectors be secured with appropriate hardware to a pc board and/or panel.
 3. Male screw retainers are used as mating hardware for connectors with 4-40 female screwlocks.

Straight Posted Connectors

Note: All part numbers are RoHS compliant.

HD-20 All-Plastic Straight Posted Connectors (Continued)

Receptacle



With Standard Mounting Hole



With Threaded Insert



With Fixed Female Screwlock

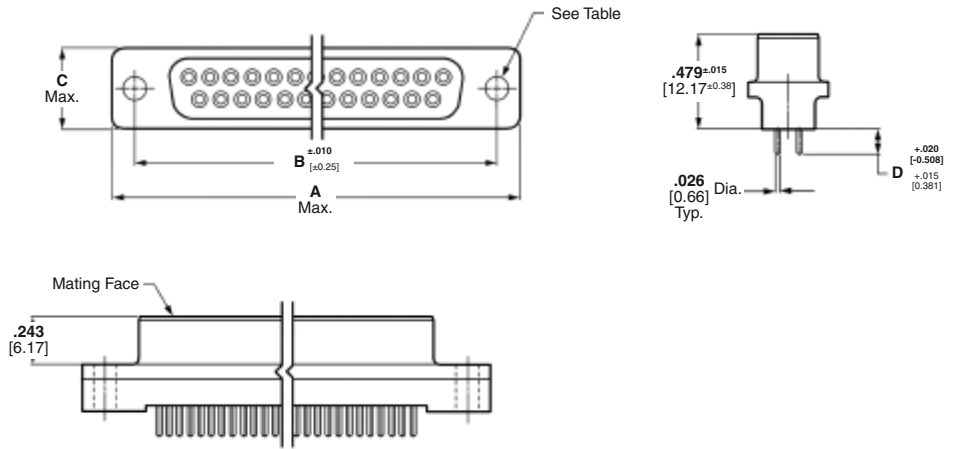

See customer drawings for pcb layouts.

Material and Finish:

Housing—94V-0 rated thermoplastic, black

Threaded Inserts—Brass, unplated

Female Screwlocks—Brass, nickel plated

Socket Contacts (Posted)—Phosphor bronze, plated as follows:
A—.000030 [0.00076] gold on mating end, tin on termination end, with entire contact .000050 [0.00127] (min.) nickel underplated
B—Gold flash on mating end, tin on termination end, with entire contact .000050 [0.00127] (min.) nickel underplated

Technical Documents:

Product Specification—108-40025

Typical Applications

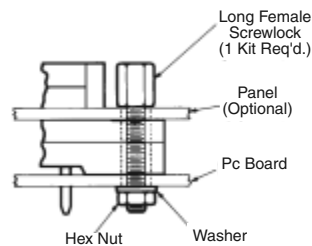

Application of connector with standard mounting holes using Long Female Screwlock Kit No. 207719

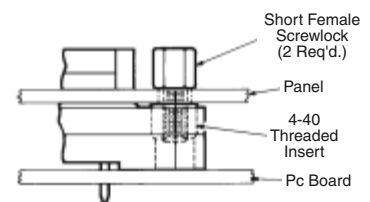

Application of connector with 4-40 Threaded Inserts using Short Female Screwlocks included in Kit No. 207952

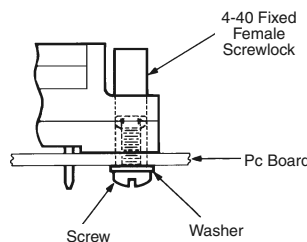

Application of connector with 4-40 Fixed Female Screwlocks. (See table on next page.)

Note: Hardware parts in illustrations above are not included with the connectors listed in the table on page 85. They are to be supplied by the Customer or, where applicable, purchased separately from TE using the part nos. specified.

Note: All part numbers are RoHS compliant.

HD-20 All-Plastic Straight Posted Connectors (Continued)

Receptacle
(Continued)

Shell Size	No. of Contact Positions	Dimensions				Contact Finish (Plating Code)	Receptacle Part Numbers		
		A	B	C	D*		With .120 [3.05] Mounting Holes	With Threaded Inserts	With Fixed Female Screwlocks
1	9	1.228 32.72	.984 24.99	.420 10.67	.125 3.18	A	5207826-4	5207841-4	5745076-4
					.170 4.32	B	5207826-3	5207841-3	5745076-3
2	15	1.546 39.27	1.312 33.33	.420 10.67	.125 3.18	A	5207827-4	5745057-4	5745077-4
					.170 4.32	B	5207827-3	5745057-3	5745077-3
3	25	2.095 53.21	1.852 47.04	.420 10.67	.125 3.18	A	5207828-4	5745058-4	5745078-4
					.170 4.32	B	5207828-3	5745058-3	5745078-3
4	37	2.737 69.52	2.500 63.50	.420 10.67	.125 3.18	A	5207829-4	5745059-4	5745079-4
					.170 4.32	A	—	—	5745079-6
5	50	2.643 67.13	2.406 61.11	.527 13.39	.125 3.18	A	—	—	5745080-4
					.170 4.32	A	—	—	5745080-6

*.125 [3.18] post length is recommended for pc board thickness of .062-.093 [1.58-2.36] max.; .170 [4.32] post length is recommended for pc board thickness of .093-.125 [2.36-3.18]; .250 [6.35] post length is for special applications.

- Notes:**
1. All receptacles are preloaded with size 20 DF posted socket contacts.
 2. It is recommended that these connectors be secured with appropriate hardware to a pc board and/or panel.
 3. Male screw retainers are used as mating hardware for connectors with 4-40 female screwlocks.

Note: All part numbers are RoHS compliant.

HD-22 Straight Subminiature D Connectors

Material and Finish:

Housing—94V-0 rated thermoplastic, black

▲ VESA Std. 15-position Receptacle Housing Material—Thermoplastic 94V-0 blue per VESA Std.

Shell—Steel, nickel plated

Contacts

Pins—Brass

Sockets—Phosphor bronze

Contact Plating—

Gold flash, .000010 [0.00025] or .000030 [0.00076] on mating end, tin on solder tails with overall nickel underplate

Boardlocks—Brass, tin plated

Female Screwlocks—Brass, nickel plated

Threaded Inserts—Brass, tin plated

Technical Documents:

Product Specification—108-1092

Application Specification—114-13199

See customer drawings for printed circuit board layouts.

■ Recognized under the Component Program of Underwriters Laboratories, Inc., File No. E28476



■ Certified by Canadian Standards Association, File No. LR 7189

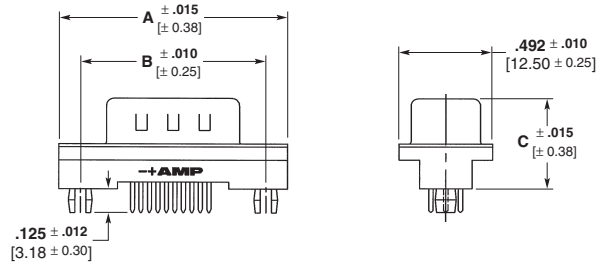

Vertical Plug

No. of Contact Positions	Dimensions			Mounting Hardware	PCB Mounting Style	Part Numbers		
	A	B	C			Gold Flash	15μ" Gold	30μ" Gold
15	1.212	.984	.476	4-40 inserts	retention pegs	5750489-4	5750489-3	5750489-1
	30.80	25.00	12.10	4-40 inserts	—	5749798-4	5749798-3	5749798-1
78	2.640	2.500	.476	4-40 inserts	—	5749019-6	5749019-5	5749019-1
	67.00	63.50	12.10					

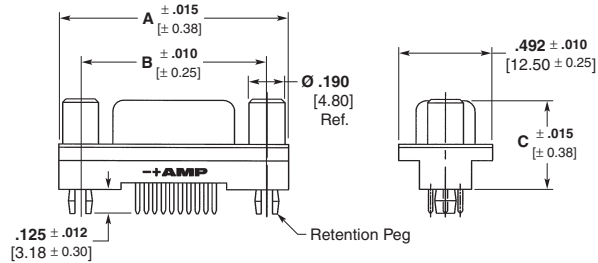

Vertical Receptacle

No. of Contact Positions	Dimensions			Mounting Hardware	PCB Mounting Style	Part Numbers		
	A	B	C			Gold Flash	15μ" Gold	30μ" Gold
15	1.212	.984	.465	4-40 inserts	—	—	5749374-7	5749374-1
	30.80	25.00	11.80	4-40 screw locks	—	5786356-4	5786356-3	5786356-1
	1.212	.984	.465	4-40 inserts	retention pegs	—	—	5749374-3
	30.80	25.00	11.80	4-40 screw locks	retention pegs	—	5786382-3	5786382-1
26	1.543	1.310	.465	4-40 inserts	—	5749030-4	5749030-3	5749030-1
	39.20	33.30	11.80	4-40 screw locks	retention pegs	5788623-4	5788623-3	—
62	2.732	2.500	.465	4-40 inserts	—	3-5747786-4	—	5747786-6
78	2.638	2.400	.476	4-40 inserts	—	1-5748831-0	5748831-9	5748831-1
	67.00	61.00	12.10					

Note: All part numbers are RoHS compliant.

HD-20 Front Metal-Shell Straight Posted Connectors With ACTION PIN Contacts

Receptacle



With Standard Mounting Holes



With Threaded Insert



With Fixed Female Screwlock

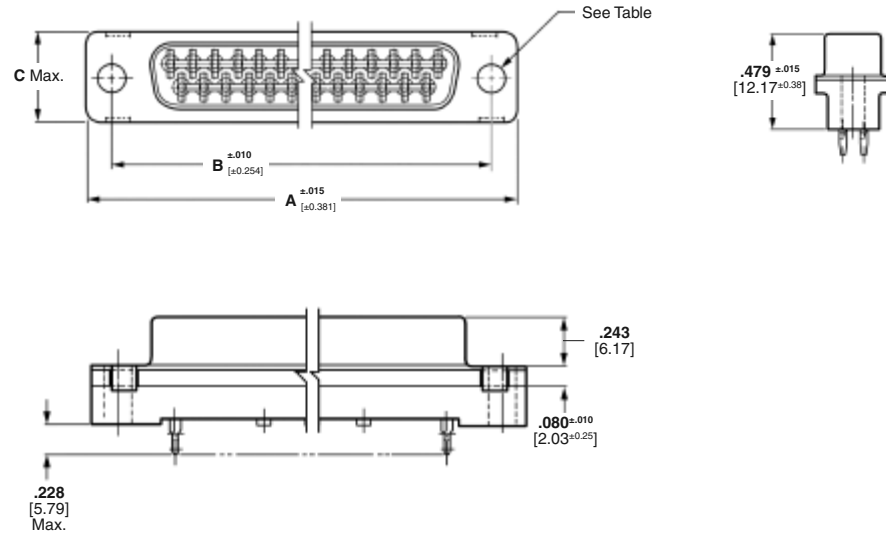

See customer drawings for pcb layouts.

Material and Finish:

Front Shell—Steel, tin plated

Housing—94V-0 rated thermoplastic, black

Threaded Inserts—Brass, unplated

Female Screwlocks—Zinc

ACTION PIN Contacts—Copper alloy, duplex plated as follows:

A—.000030 [0.00076] gold on mating end, tin on ACTION PIN post surface, with entire contact .000050 [0.00127] (min.) nickel underplated

B—Gold flash on mating end, tin on ACTION PIN post surface, with entire contact .000050 [0.00127] (min.) nickel underplated

Technical Documents:

Product Specification—108-40014

Application Specification—114-40026

For .062 [1.57] min. Thick Pc Boards

Shell Size	No. of Contact Positions	Dimensions			Contact Finish (Plating Code)	Receptacle Part Numbers			Seating Tool Part No.
		A	B	C		With .120 [3.05] Mounting Holes	With Threaded Inserts	With Fixed Female Screwlocks	
1	9	1.213 30.81	.984 24.99	.509 12.93	A	—	—	—	91164-2
2	15	1.541 39.14	1.312 33.33	.509 12.93	A	—	—	—	91165-2
3	25	2.088 53.04	1.852 47.04	.509 12.93	B	—	—	5748688-1	91168-2
5	50	2.635 66.93	2.406 61.11	.620 15.75	A	—	5748485-2	—	91167-2

For .093 [2.36] min. Thick Pc Boards

Shell Size	No. of Contact Positions	Dimensions			Contact Finish (Plating Code)	Receptacle Part Numbers			Seating Tool Part No.
		A	B	C		With .120 [3.05] Mounting Holes	With Threaded Inserts	With Fixed Female Screwlocks	
1	9	1.213 30.81	.984 24.99	.509 12.93	A	5747089-2	5747090-2	5747091-2	91164-2
2	15	1.541 39.14	1.312 33.32	.509 12.93	A	5747140-2	5747141-2	5747142-2	91165-2
3	25	2.088 53.04	1.852 47.04	.509 12.93	A	5745922-2	5745925-2	5745928-2	91168-2
4	37	2.729 69.32	2.500 63.50	.509 12.93	A B	5747713-2 —	5747714-2 5747714-1	5747715-2 —	91166-2
5	50	2.635 66.93	2.406 61.11	.620 15.75	A	5747143-2	5747144-2	5747145-2	91167-2

- Notes:**
1. All receptacles are preloaded with straight posted ACTION PIN socket contacts.
 2. Male screw retainers are used as mating hardware for connectors with 4-40 female screwlocks.

Note: All part numbers are RoHS compliant.

HD-20 Front Metal-Shell Straight Posted Connectors With ACTION PIN Contacts (Continued)

Plug



With Standard Mounting Holes



With Threaded Insert



With Fixed Female Screwlock

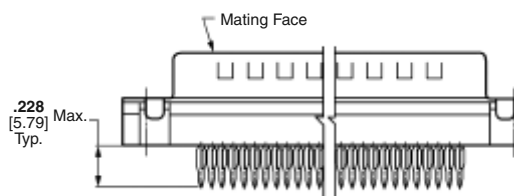
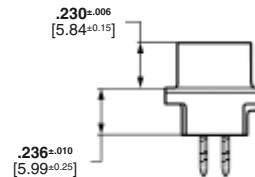
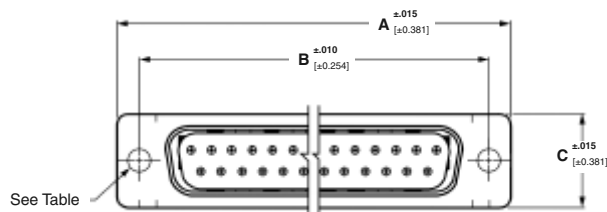

See customer drawings for pcb layouts.

Material and Finish:

Front Shell—Steel, tin plated

Housing—94V-0 rated thermoplastic, black

Threaded Inserts—Brass, unplated

Female Screwlocks—Zinc

ACTION PIN Contacts—Copper alloy, duplex plated as follows:

A—.000030 [0.00076] gold on mating end, tin on ACTION PIN post surface, with entire contact .000050 [0.00127] (min.) nickel underplated

For .093 [2.36] min. Thick Pc Board

Shell Size	No. of Contact Positions	Dimensions			Contact Finish (Plating Code)	Plug Part Numbers			Seating Tool Part No.
		A	B	C		With .120 [3.05] Mounting Holes	With Threaded Inserts	With Fixed Female Screwlocks	
1	9	1.213 30.81	.984 24.99	.494 12.55	A	—	5786830-1	5787176-1	58274-3
2	15	1.541 39.14	1.312 33.32	.494 12.55	A	—	—	5787177-1	58274-6
3	25	2.088 53.04	1.852 47.04	.494 12.55	A	5748146-2	5748146-4	5748146-6	58274-1
4	37	2.732 69.39	2.500 63.50	.494 12.55	A	5788458-1	5786534-1	5750060-1	58274-5
5	50	2.635 66.93	2.406 61.11	.605 15.37	A	—	5749892-1	—	58273-1

- Notes:** 1. All plugs are preloaded with straight posted ACTION PIN pin contacts.
2. Male screw retainers are used as mating hardware for connectors with 4-40 female screwlocks.

Technical Documents:

Product Specification—108-40014

Application Specification—
114-40026

Note: All part numbers are RoHS compliant.

HD-20 All-Plastic Straight Posted Connectors With ACTION PIN Contacts

Receptacles (Low and High Profile)



With Standard Mounting Holes



With Threaded Insert



With Fixed Female Screwlock

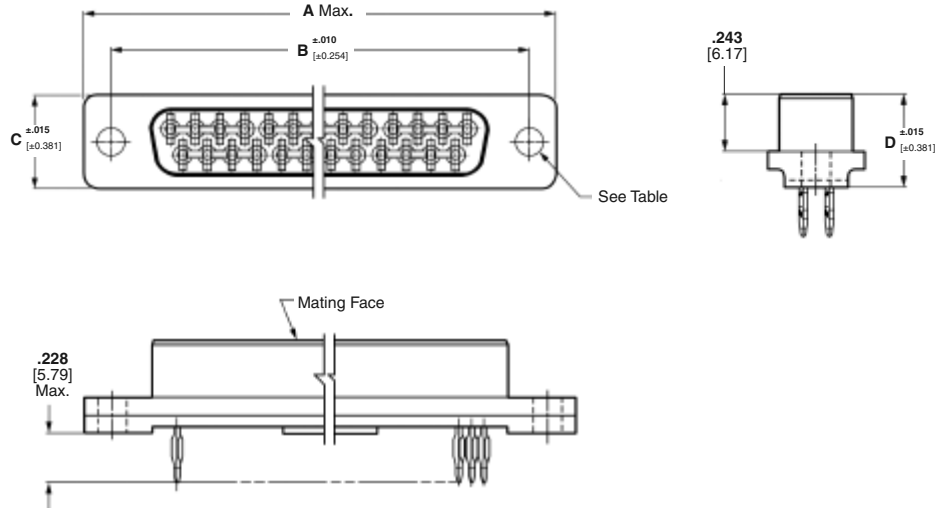

See customer drawings for pcb layouts.

Material and Finish:

Housing—94V-0 rated thermoplastic, black

Threaded Inserts—Brass, unplated

Female Screwlocks—Brass, nickel plated

ACTION PIN Contacts—Copper alloy, duplex plated as follows:

A—.000030 [0.00076] gold on mating end, tin on ACTION PIN post surface, with entire contact .000050 [0.00127] (min.) nickel underplated

B—Gold flash on mating end, tin on ACTION PIN post surface, with entire contact .000050 [0.00127] (min.) nickel underplated

Technical Documents:

Product Specification—108-40014

Shell Size	No. of Contact Positions	Dimensions				Profile	Contact Finish (Plating Code)	Receptacle Part Numbers						Seating Tool Part No.
		A	B	C	D			For .093 [2.36] (min.) Thick Pc Boards			For .062 [1.57] (min.) Thick PC Boards			
								With .120 [3.05] Mounting Holes	With Threaded Inserts	With Fixed Female Screwlocks	With .120 [3.05] Mounting Holes	With Threaded Inserts	With Fixed Female Screwlocks	
1	9	1.221 31.01	.984 24.99	.410 10.41	.395 10.03	Low	A	—	—	5745454-2	—	—	—	91164-1
						High	A	—	—	5745455-2	—	—	—	91164-3
2	15	1.546 39.27	1.312 33.32	.410 10.41	.395 10.03	Low	A	—	—	5745456-2	—	—	—	91165-1
						High	A	—	—	—	—	5745612-2	—	—
3	25	2.095 53.21	1.852 47.04	.410 10.41	.395 10.03	Low	A	—	—	5745458-2	—	—	—	91168-1
						High	A	—	—	5745458-1	—	—	—	—
4	37	2.737 69.52	2.500 63.50	.410 10.41	.395 10.03	Low	A	—	—	5745459-2	5745589-2	—	—	91166-1
						High	A	—	—	5745461-2	—	—	—	—

- Notes:** 1. All receptacles are preloaded with straight posted ACTION PIN socket contacts.
2. Male screw retainers are used as mating hardware for connectors with 4-40 female screwlocks.

Note: All part numbers are RoHS compliant.

Компания «Life Electronics» занимается поставками электронных компонентов импортного и отечественного производства от производителей и со складов крупных дистрибьюторов Европы, Америки и Азии.

С конца 2013 года компания активно расширяет линейку поставок компонентов по направлению коаксиальный кабель, кварцевые генераторы и конденсаторы (керамические, пленочные, электролитические), за счёт заключения дистрибьюторских договоров

Мы предлагаем:

- Конкурентоспособные цены и скидки постоянным клиентам.
- Специальные условия для постоянных клиентов.
- Подбор аналогов.
- Поставку компонентов в любых объемах, удовлетворяющих вашим потребностям.
- Приемлемые сроки поставки, возможна ускоренная поставка.
- Доставку товара в любую точку России и стран СНГ.
- Комплексную поставку.
- Работу по проектам и поставку образцов.
- Формирование склада под заказчика.
- Сертификаты соответствия на поставляемую продукцию (по желанию клиента).
- Тестирование поставляемой продукции.
- Поставку компонентов, требующих военную и космическую приемку.
- Входной контроль качества.
- Наличие сертификата ISO.

В составе нашей компании организован Конструкторский отдел, призванный помогать разработчикам, и инженерам.

Конструкторский отдел помогает осуществить:

- Регистрацию проекта у производителя компонентов.
- Техническую поддержку проекта.
- Защиту от снятия компонента с производства.
- Оценку стоимости проекта по компонентам.
- Изготовление тестовой платы монтаж и пусконаладочные работы.



Тел: +7 (812) 336 43 04 (многоканальный)

Email: org@lifeelectronics.ru