

Optocoupler, Phototransistor Output, with Base Connection in SOIC-8 Package, 110 °C Rated

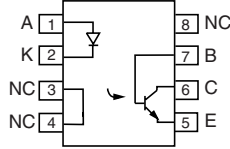

FEATURES

- Operating temperature from - 55 °C to + 110 °C
- High BV_{CEO} , 70 V
- Isolation test voltage, 4000 V_{RMS}
- Industry standard SOIC-8 surface mountable package
- Compatible with dual wave, vapor phase and IR reflow soldering
- Lead (Pb)-free component
- Component in accordance to RoHS 2002/95/EC and WEEE 2002/96/EC

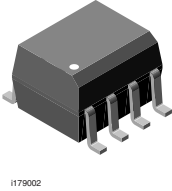

RoHS
COMPLIANT

DESCRIPTION

The 110 °C IL1205AT/1206AT/1207AT/1208AT are optically coupled pairs with a gallium arsenide infrared LED and a silicon NPN phototransistor. Signal information, including a DC level, can be transmitted by the device while maintaining a high degree of electrical isolation between input and output. This family comes in a standard SOIC-8 small outline package for surface mounting which makes them ideally suited for high density application with limited space. In addition to eliminating through-hole requirements, this package conforms to standards for surface mounted devices.

A specified minimum and maximum CTR allows a narrow tolerance in the electrical design of the adjacent circuits. The high BV_{CEO} of 70 V gives a higher safety margin compared to the industry standard 30 V.

APPLICATIONS

- AC adapters
- PLCs
- Switch mode power supplies
- DC/DC converters
- Microprocessor I/O interfaces
- General impedance matching circuits

AGENCY APPROVALS

- UL1577 - file no. E52744 system code Y
- CUL - file no. E52744, equivalent to CSA bulletin 5A
- DIN EN 60747-5-5 available with option 1

ORDER INFORMATION	
PART	REMARKS
IL1205AT	CTR 40 to 80 %, SOIC-8
IL1206AT	CTR 63 to 125 %, SOIC-8
IL1207AT	CTR 100 to 200 %, SOIC-8
IL1208AT	CTR 160 to 320 %, SOIC-8

ABSOLUTE MAXIMUM RATINGS (1)				
PARAMETER	TEST CONDITION	SYMBOL	VALUE	UNIT
INPUT				
Continuous forward current		I_F	60	mA
Peak reverse voltage		V_R	6.0	V
Power dissipation		P_{diss}	90	mW
Derate linearly from 25 °C			0.9	mW/°C
OUTPUT				
Collector emitter voltage		V_{CE}	70	V
Collector current		I_C	50	mA
	$t < 1.0$ ms	I_C	100	mA
Power dissipation		P_{diss}	150	mW
Derate linearly from 25 °C			1.5	mW/°C

IL1205AT/1206AT/1207AT/1208AT



Vishay Semiconductors Optocoupler, Phototransistor Output,
with Base Connection in SOIC-8
Package, 110 °C Rated

ABSOLUTE MAXIMUM RATINGS ⁽¹⁾				
PARAMETER	TEST CONDITION	SYMBOL	VALUE	UNIT
COUPLER				
Isolation test voltage		V_{ISO}	4000	V_{RMS}
Operating temperature		T_{amb}	- 55 to + 110	°C
Total package dissipation (LED and detector)		P_{tot}	240	mW
Storage temperature		T_{stg}	- 55 to + 150	°C
Soldering temperature ⁽²⁾	max. 10 s, dip soldering distance to seating plane \geq 1.5 mm	T_{sld}	260	°C
Derate linearly from 25 °C			2.4	mW/°C

Notes

(1) $T_{amb} = 25$ °C, unless otherwise specified.

Stresses in excess of the absolute maximum ratings can cause permanent damage to the device. Functional operation of the device is not implied at these or any other conditions in excess of those given in the operational sections of this document. Exposure to absolute maximum ratings for extended periods of the time can adversely affect reliability.

(2) Refer to reflow profile for soldering conditions for surface mounted devices (SOP/SOIC).

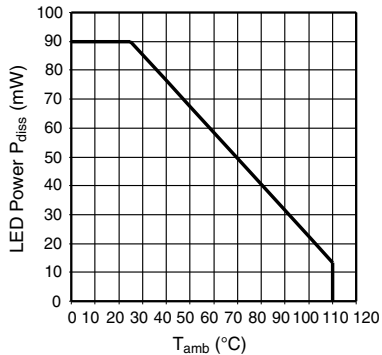

Fig. 1 - Input Power Dissipation (LED) vs. Ambient Temperature

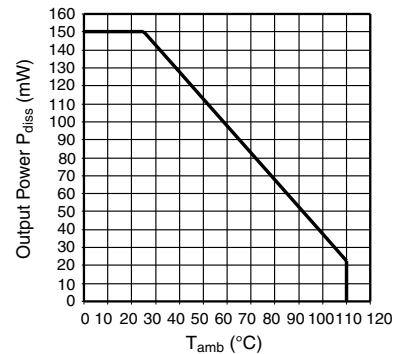

Fig. 2 - Output Power Dissipation vs. Ambient Temperature

ELECTRICAL CHARACTERISTICS							
PARAMETER	TEST CONDITION	PART	SYMBOL	MIN.	TYP.	MAX.	UNIT
INPUT							
Forward voltage	$I_F = 10$ mA		V_F		1.3	1.5	V
Reverse current	$V_R = 6$ V		I_R		0.1	100	μ A
Capacitance	$V_R = 0$ V		C_I		13		pF
OUTPUT							
Collector emitter leakage current	$V_{CE} = 10$ V		I_{CEO}		5.0	50	nA
Collector emitter breakdown voltage	$I_C = 100$ μ A		BV_{CEO}	70			V
Emitter collector breakdown voltage	$I_E = 100$ μ A		BV_{ECO}	7.0	10		V
Collector base breakdown current			BV_{CBO}	70			V
Saturation voltage, collector emitter	$I_C = 2$ mA, $I_F = 10$ mA		V_{CEsat}			0.4	V
COUPLER							
DC current transfer ratio	$I_F = 10$ mA, $V_{CE} = 5.0$ V	IL1205AT	CTR	40		80	%
		IL1206AT	CTR	63		125	%
		IL1207AT	CTR	100		200	%
		IL1208AT	CTR	100		320	%
	$I_F = 1.0$ mA, $V_{CE} = 5.0$ V	IL1205AT	CTR	13	25		%
		IL1206AT	CTR	22	40		%
		IL1207AT	CTR	34	60		%
		IL1208AT	CTR	56	95		%
Capacitance (input to output)			C_{IO}		0.5		pF

Note

$T_{amb} = 25$ °C, unless otherwise specified.

Minimum and maximum values were tested requirements. Typical values are characteristics of the device and are the result of engineering evaluations. Typical values are for information only and are not part of the testing requirements.



IL1205AT/1206AT/1207AT/1208AT

Optocoupler, Phototransistor Output, Vishay Semiconductors
with Base Connection in SOIC-8
Package, 110 °C Rated

SWITCHING CHARACTERISTICS						
PARAMETER	TEST CONDITION	SYMBOL	MIN.	TYP.	MAX.	UNIT
Turn-on time	$I_C = 2 \text{ mA}$, $R_L = 100 \Omega$, $V_{CC} = 10 \text{ V}$	t_{on}		3.0		μs
Turn-off time	$I_C = 2 \text{ mA}$, $R_L = 100 \Omega$, $V_{CC} = 10 \text{ V}$	t_{off}		3.0		μs

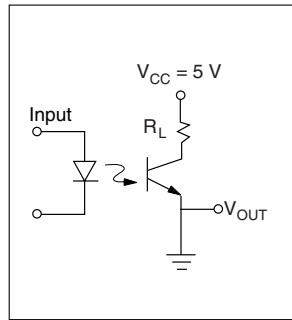

i205at_11

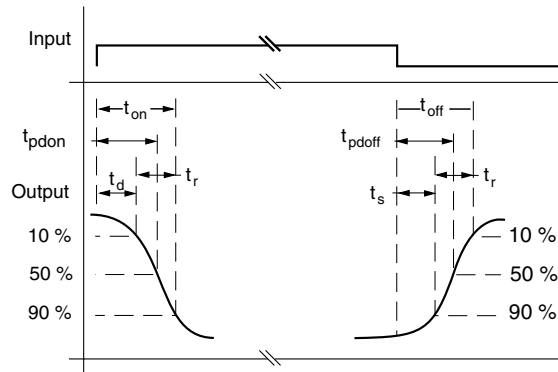

Fig. 3 Switching Test Circuit

SAFETY AND INSULATION RATINGS						
PARAMETER	TEST CONDITION	SYMBOL	MIN.	TYP.	MAX.	UNIT
Climatic classification (according to IEC 68 part 1)				55/110/21		
Pollution degree (DIN VDE 0109)				2.0		
Comparative tracking index per DIN IEC 112/VDE 0303 part 1, group IIIa per DIN VDE 6110 175 399		CTI	175		399	
V_{IOTM}		V_{IOTM}	6000			V
V_{IORM}		V_{IORM}	560			V
Resistance (input to output)		R_{IO}		10^{12}		Ω
P_{SI}					350	mW
I_{SI}					150	mA
T_{SI}					165	$^{\circ}\text{C}$
Creepage distance			4.0			mm
Clearance distance			4.0			mm

Note

As per IEC 60747-5-2, §7.4.3.8.1, this optocoupler is suitable for “safe electrical insulation” only within the safety ratings. Compliance with the safety ratings shall be ensured by means of protective circuits.

IL1205AT/1206AT/1207AT/1208AT



Vishay Semiconductors Optocoupler, Phototransistor Output,
with Base Connection in SOIC-8
Package, 110 °C Rated

TYPICAL CHARACTERISTICS

$T_{amb} = 25\text{ °C}$, unless otherwise specified

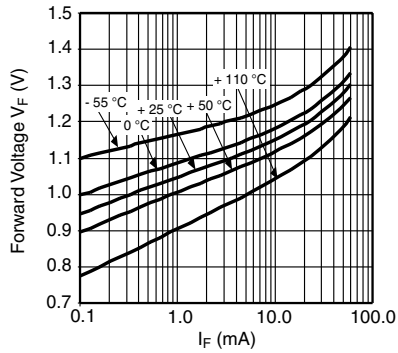

Fig. 4 - Diode Forward Voltage V_F vs. Forward Current

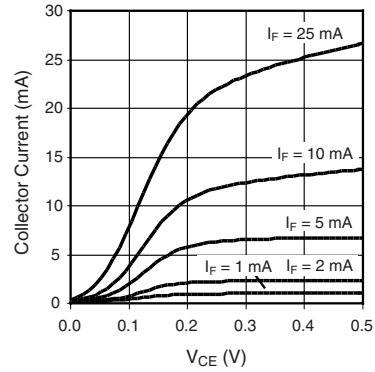

Fig. 7 - I_C (Saturated) vs. V_{CE}

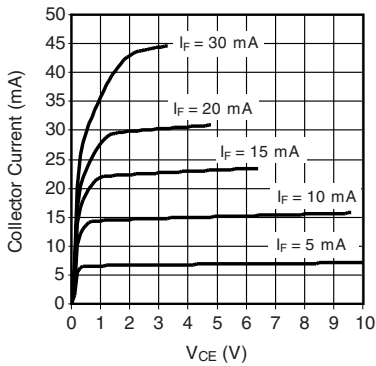

Fig. 5 - I_C (Unsaturated) vs. V_{CE}

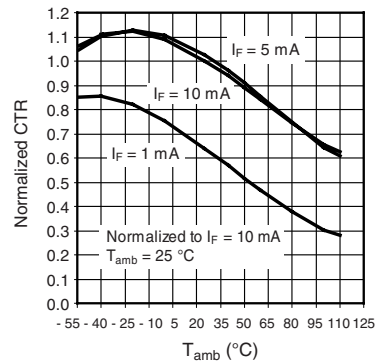

Fig. 8 - CTR Normalized to $I_F = 10\text{ mA}$ vs. Ambient Temperature, (Saturated, $V_{CE} = 0.4\text{ V}$)

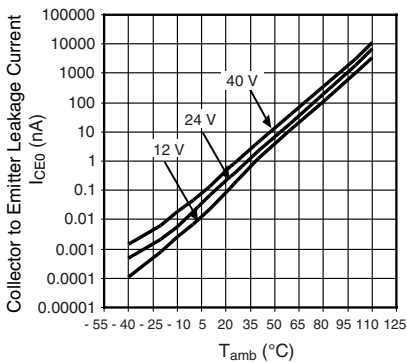

Fig. 6 - Collector to Emitter Current vs. Ambient Temperature

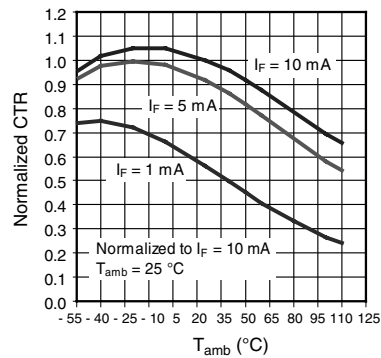

Fig. 9 - CTR Normalized to $I_F = 10\text{ mA}$ vs. Ambient Temperature, (Non-Saturated, $V_{CE} = 5\text{ V}$)



IL1205AT/1206AT/1207AT/1208AT

Optocoupler, Phototransistor Output, Vishay Semiconductors
with Base Connection in SOIC-8
Package, 110 °C Rated

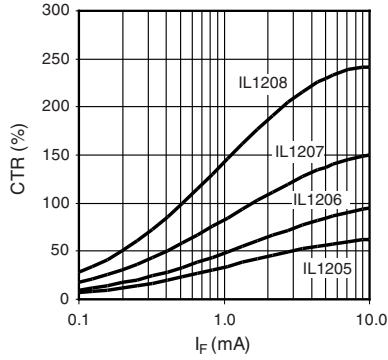

Fig. 10 - CTR vs. I_F, (V_{CE} = 5 V, T_{amb} = 25 °C) (Not Normalised)

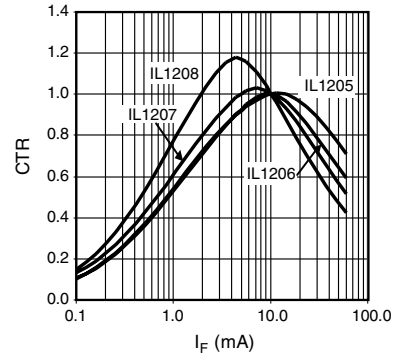

Fig. 13 - CTR vs. I_F Saturated, Normalised to I_F = 10 mA, T_{amb} = 25 °C

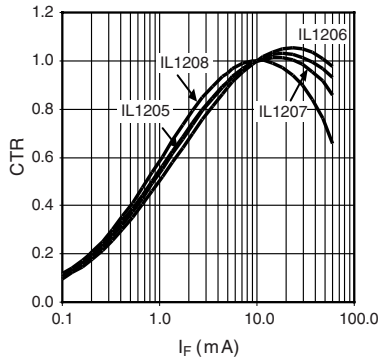

Fig. 11 - CTR vs. I_F, (V_{CE} = 5 V, T_{amb} = 25 °C) Normalised to I_F = 10 mA, T_{amb} = 25 °C

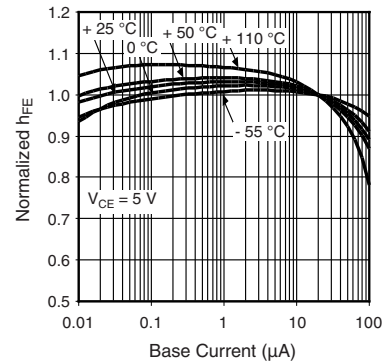

Fig. 14 - Normalized h_{FE} vs. Base Current and T_{amb} (Non-Saturated Condition)

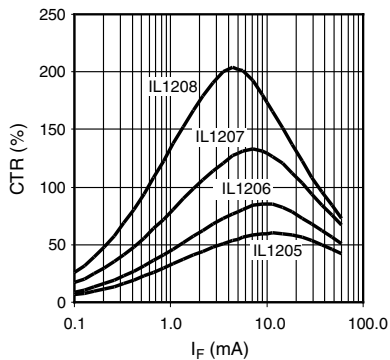

Fig. 12 - CTR vs. I_F Saturated, (V_{CE} = 0.4 V, T_{amb} = 25 °C)

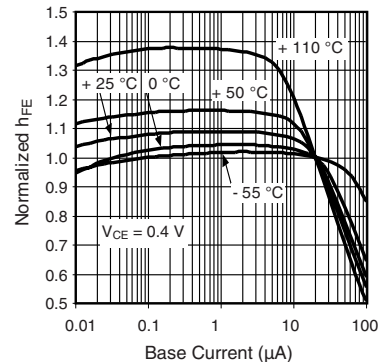

Fig. 15 - Normalized h_{FE} vs. Base Current and T_{amb} (Saturated Condition)

IL1205AT/1206AT/1207AT/1208AT



Vishay Semiconductors Optocoupler, Phototransistor Output,
with Base Connection in SOIC-8
Package, 110 °C Rated

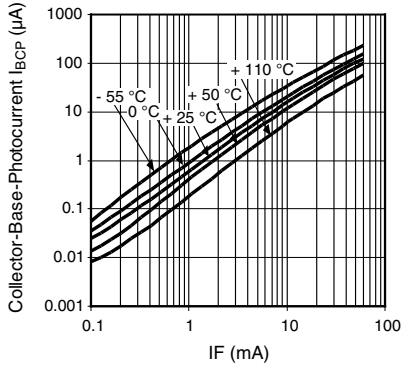

Fig. 16 - Collector Base Photocurrent vs. I_F

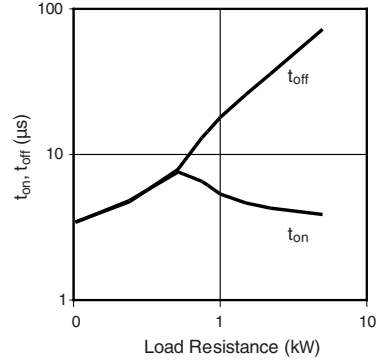

Fig. 19 - Switching Time t_{on} , t_{off} vs. Load Resistance (100 Ω to 5000 Ω)

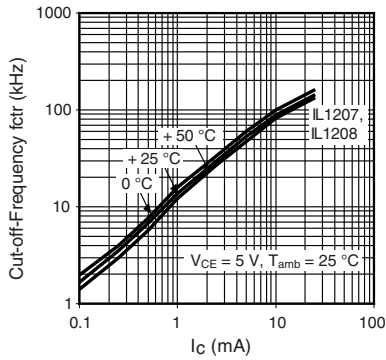

Fig. 17 - Cut-Off-Frequency (-3 dB) vs. Collector Current

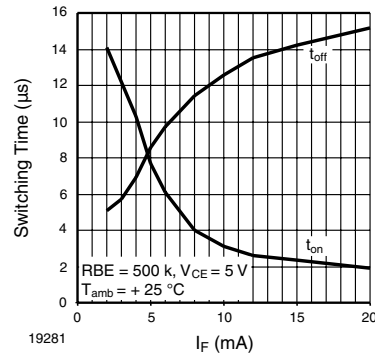

Fig. 20 - Switching Time vs. I_F

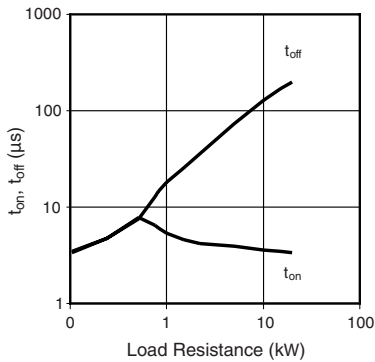

Fig. 18 - Switching Time t_{on} , t_{off} vs. Load Resistance

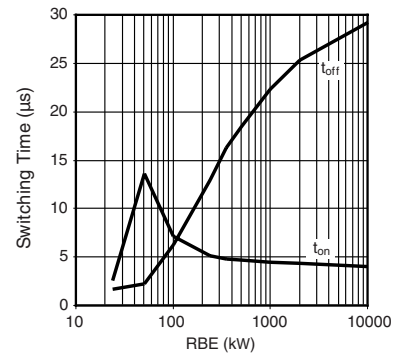

Fig. 21 - Switching Time vs. RBE, $I_F = 10$ mA



IL1205AT/1206AT/1207AT/1208AT

Optocoupler, Phototransistor Output, Vishay Semiconductors
with Base Connection in SOIC-8

Package, 110 °C Rated

PACKAGE DIMENSIONS in inches (millimeters)

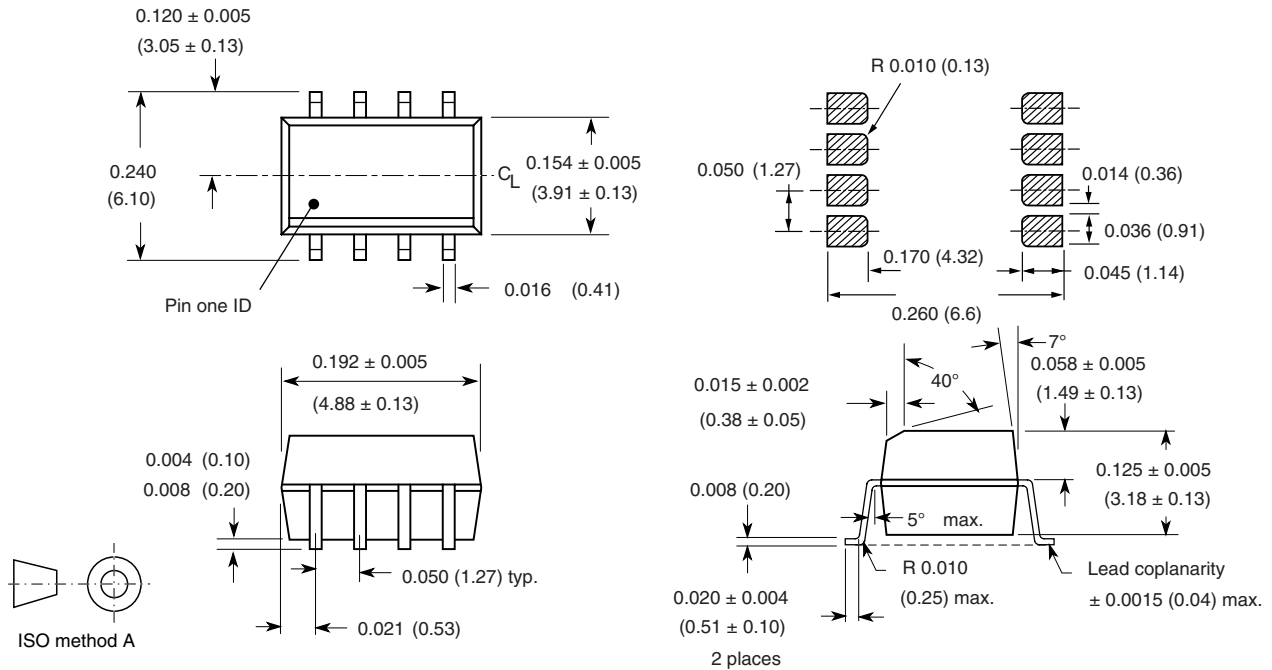

i178003



Vishay Semiconductors Optocoupler, Phototransistor Output,
with Base Connection in SOIC-8
Package, 110 °C Rated

OZONE DEPLETING SUBSTANCES POLICY STATEMENT

It is the policy of Vishay Semiconductor GmbH to

1. Meet all present and future national and international statutory requirements.
2. Regularly and continuously improve the performance of our products, processes, distribution and operating systems with respect to their impact on the health and safety of our employees and the public, as well as their impact on the environment.

It is particular concern to control or eliminate releases of those substances into the atmosphere which are known as ozone depleting substances (ODSs).

The Montreal Protocol (1987) and its London Amendments (1990) intend to severely restrict the use of ODSs and forbid their use within the next ten years. Various national and international initiatives are pressing for an earlier ban on these substances.

Vishay Semiconductor GmbH has been able to use its policy of continuous improvements to eliminate the use of ODSs listed in the following documents.

1. Annex A, B and list of transitional substances of the Montreal Protocol and the London Amendments respectively.
2. Class I and II ozone depleting substances in the Clean Air Act Amendments of 1990 by the Environmental Protection Agency (EPA) in the USA.
3. Council Decision 88/540/EEC and 91/690/EEC Annex A, B and C (transitional substances) respectively.

Vishay Semiconductor GmbH can certify that our semiconductors are not manufactured with ozone depleting substances and do not contain such substances.

We reserve the right to make changes to improve technical design
and may do so without further notice.

Parameters can vary in different applications. All operating parameters must be validated for each customer application by the customer. Should the buyer use Vishay Semiconductors products for any unintended or unauthorized application, the buyer shall indemnify Vishay Semiconductors against all claims, costs, damages, and expenses, arising out of, directly or indirectly, any claim of personal damage, injury or death associated with such unintended or unauthorized use.

Vishay Semiconductor GmbH, P.O.B. 3535, D-74025 Heilbronn, Germany



Disclaimer

All product specifications and data are subject to change without notice.

Vishay Intertechnology, Inc., its affiliates, agents, and employees, and all persons acting on its or their behalf (collectively, "Vishay"), disclaim any and all liability for any errors, inaccuracies or incompleteness contained herein or in any other disclosure relating to any product.

Vishay disclaims any and all liability arising out of the use or application of any product described herein or of any information provided herein to the maximum extent permitted by law. The product specifications do not expand or otherwise modify Vishay's terms and conditions of purchase, including but not limited to the warranty expressed therein, which apply to these products.

No license, express or implied, by estoppel or otherwise, to any intellectual property rights is granted by this document or by any conduct of Vishay.

The products shown herein are not designed for use in medical, life-saving, or life-sustaining applications unless otherwise expressly indicated. Customers using or selling Vishay products not expressly indicated for use in such applications do so entirely at their own risk and agree to fully indemnify Vishay for any damages arising or resulting from such use or sale. Please contact authorized Vishay personnel to obtain written terms and conditions regarding products designed for such applications.

Product names and markings noted herein may be trademarks of their respective owners.

Компания «Life Electronics» занимается поставками электронных компонентов импортного и отечественного производства от производителей и со складов крупных дистрибьюторов Европы, Америки и Азии.

С конца 2013 года компания активно расширяет линейку поставок компонентов по направлению коаксиальный кабель, кварцевые генераторы и конденсаторы (керамические, пленочные, электролитические), за счёт заключения дистрибьюторских договоров

Мы предлагаем:

- Конкурентоспособные цены и скидки постоянным клиентам.
- Специальные условия для постоянных клиентов.
- Подбор аналогов.
- Поставку компонентов в любых объемах, удовлетворяющих вашим потребностям.
- Приемлемые сроки поставки, возможна ускоренная поставка.
- Доставку товара в любую точку России и стран СНГ.
- Комплексную поставку.
- Работу по проектам и поставку образцов.
- Формирование склада под заказчика.
- Сертификаты соответствия на поставляемую продукцию (по желанию клиента).
- Тестирование поставляемой продукции.
- Поставку компонентов, требующих военную и космическую приемку.
- Входной контроль качества.
- Наличие сертификата ISO.

В составе нашей компании организован Конструкторский отдел, призванный помогать разработчикам, и инженерам.

Конструкторский отдел помогает осуществить:

- Регистрацию проекта у производителя компонентов.
- Техническую поддержку проекта.
- Защиту от снятия компонента с производства.
- Оценку стоимости проекта по компонентам.
- Изготовление тестовой платы монтаж и пусконаладочные работы.



Тел: +7 (812) 336 43 04 (многоканальный)

Email: org@lifeelectronics.ru