

Product Guide

WaveAnalyzer
High-Resolution Optical
Spectral Analysis

FINISAR[®]



WaveAnalyzer—High Resolution Optical Spectral Analysis

The WaveAnalyzer™ 1500S Optical Spectrum Analyzer is a real-time, very-high-resolution optical spectrum analyzer for R&D and production test applications. Based on Finisar's fast-stepping solid-state laser, the WaveAnalyzer 1500S uses coherent detection techniques to achieve an outstanding combination of resolution, dynamic range and measurement speed.

This next-generation Optical Spectrum Analyzer provides spectral measurements with sub-pm resolution at an update rate of 4 measurements per second across the entire C-band. Scanning across smaller spectral regions is even faster, with update rates of over 10 measurements per second across any 200 GHz window, enabling interactive adjustment of optical components and systems.

The WaveAnalyzer's coherent receiver provides polarization resolved data of the signal whilst its two input ports, for different power levels, ensures coverage of a large range of optical input signals; low power single channel signals can be analyzed as accurately as high power WDM signals.

The WaveAnalyzer 1500S is very compact and rugged, as it contains no moving parts. It is controlled using a USB or Ethernet connection to a Windows-based computer which runs Finisar's WaveAnalyzer software package. A Graphical User Interface (GUI) and an Application Programming Interface (API) are both provided.

Key Features

- ▶ High spectral resolution
- ▶ Real time measurement
- ▶ Update rate:
 - 4 Hz for full C-band scan
 - 10 Hz for scan across any 200 GHz window
- ▶ Spurious-free dynamic range > 50 dB
- ▶ Full C-band coverage
- ▶ External trigger
- ▶ Internal web server



WaveAnalyzer 1500S – High Resolution Optical Spectrum Analyzer

Applications

- ▶ High-resolution spectral analysis on optical components
- ▶ Optical Signal to Noise Ratio (OSNR) measurements
- ▶ Modulation analysis on optical signals
- ▶ Modulator test
- ▶ Modulator bias and polarization adjustments
- ▶ Transceiver test
- ▶ Side-mode Suppression Ratio (SMSR) measurements
- ▶ Network monitoring
- ▶ General Purpose spectral analysis in optical labs

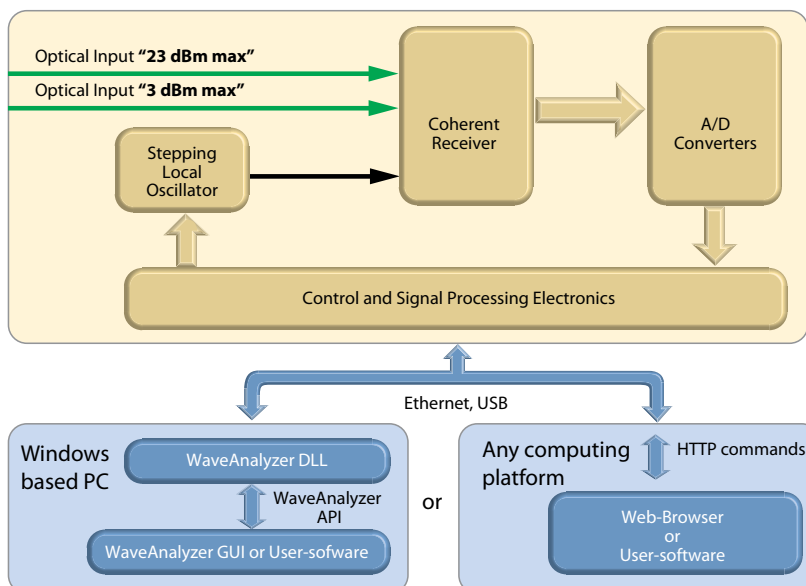

Block diagram of WaveAnalyzer system

Measurement

The WaveAnalyzer 1500S supports spectral measurement applications in various domains, including communications and pulsed lasers, as shown in the examples below.

10G channels, 50GHz spaced, with various modulation formats

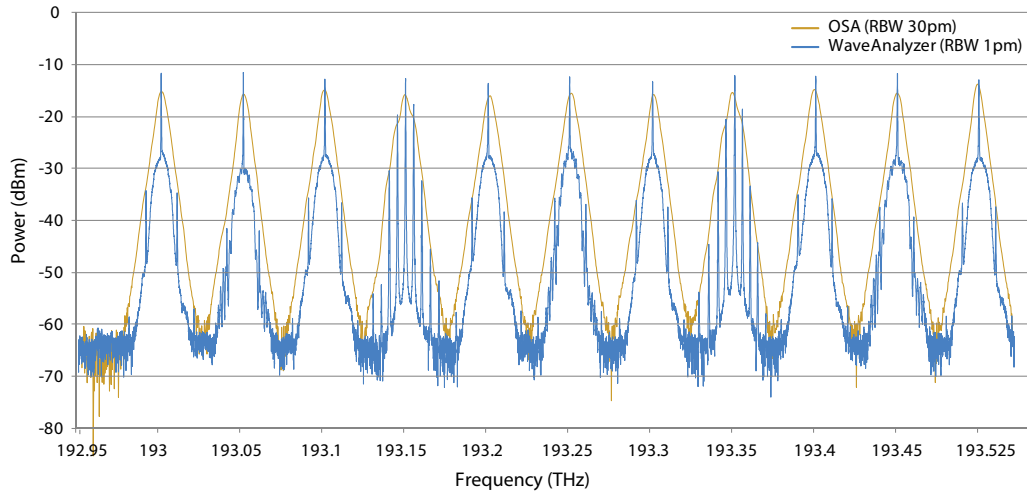

10 Gb/s NRZ

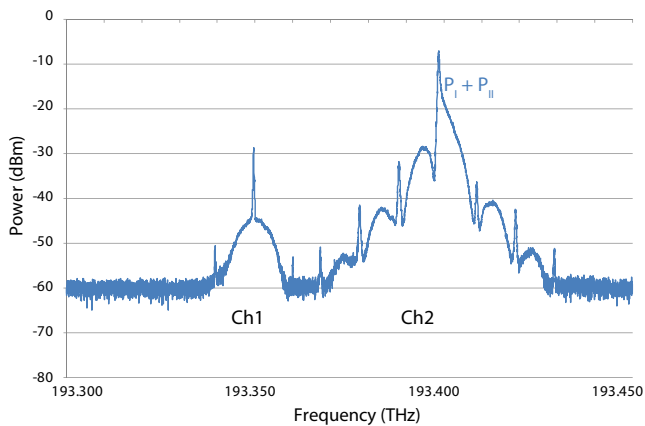

Two 10 Gb/s channels separated by 50 GHz; Channel 1 being attenuated by 20 dB. The graph above shows the sum of the two polarization components P_I and P_{II} , whereas the graph below displays the polarization components P_I and P_{II} separately.

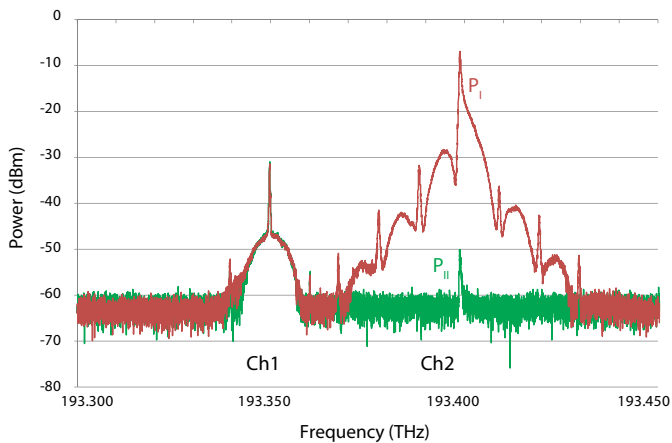

4 channel 100G DQPSK

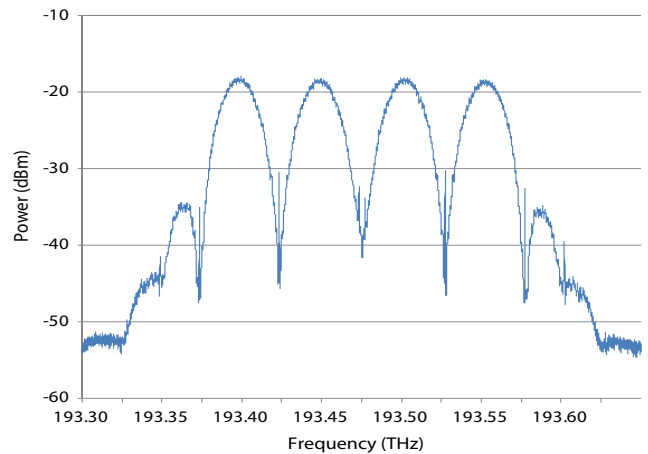

Measurement taken on 4 channels of a dual polarization DQPSK signal, spaced by 50 GHz

40 GHz mode-locked laser

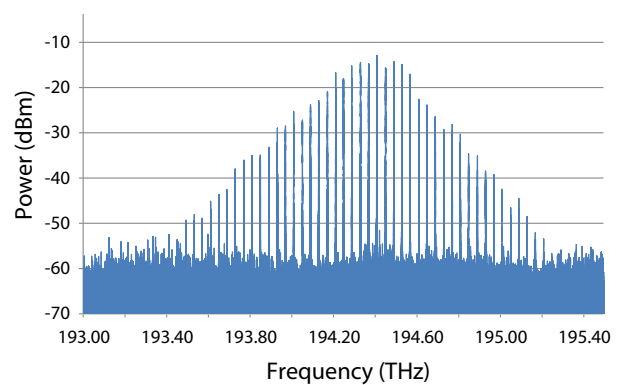

Spectral details of the mode-structure of a 40 GHz mode-locked laser. The real-time update rate supports precise adjustment of the laser cavity.

Measurement Analysis Functions

The PC based Graphic User Interface package offers various analysis functions:

The **3-point-measurement** allows very simple and quick OSNR measurements using the traditional approach in which a 0.1nm resolution bandwidth measurement scan is taken from which the noise and the signal powers are estimated.

The **advanced 6-point-measurement** allows OSNR measurements even between densely spaced channels, see figure on the right. The measurement bands can be precisely adjusted to capture the noise floor and the signal accurately.

The **polarization extinction ratio method** allows in-band OSNR measurements, provided the optical signal is single polarization only (which can be verified with the WaveAnalyzer instrument).

The **WDM channel analysis** function provides measurements of the OSNR, channel power and channel center frequency of all channels simultaneously with an update rate of up to 10 Hz, depending on scan range. For documentation or further analysis, the results can be exported in a table.

The **Wavelength Meter** function provides fast measurements of the power and the wavelength of multiple narrow band signals. It can measure several hundred lines simultaneously and provides a wavelength accuracy which is similar to dedicated wavelength meters.

Markers

The user interface contains a powerful marker scheme which supports further analysis capabilities, like peak detection, display of difference frequencies and integrated power in user definable frequency ranges.

Interfacing

The user can connect to the WaveAnalyzer in point-to-point mode from a computer using an Ethernet or USB connection, or Remote Network Device mode over an IP network.

To ensure fastest measurement rates, it is preferred to connect the WaveAnalyzer directly to the user's computer via a Gigabit Ethernet connection using the point-to-point mode.

Trigger scheme

The WaveAnalyzer 1500S includes a trigger scheme which allows taking measurement samples in precisely defined time windows. This enables, for example, taking spectral measurements of signals traveling in recirculating loops.

HTTP based programming interface

The WaveAnalyzer 1500S offers an HTTP based programming interface. This greatly simplifies remotely controlling the instrument, as it is independent of the programming platform.

Web server

The WaveAnalyzer instrument includes a simple web server which allows controlling the instrument and taking measurements with a web browser.

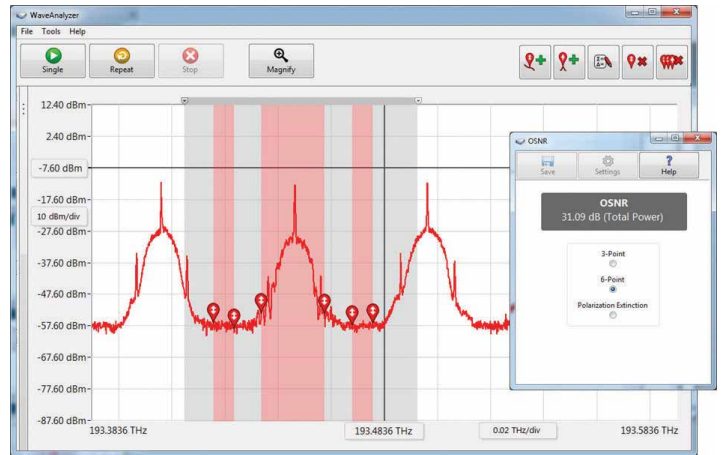

6-point OSNR measurement

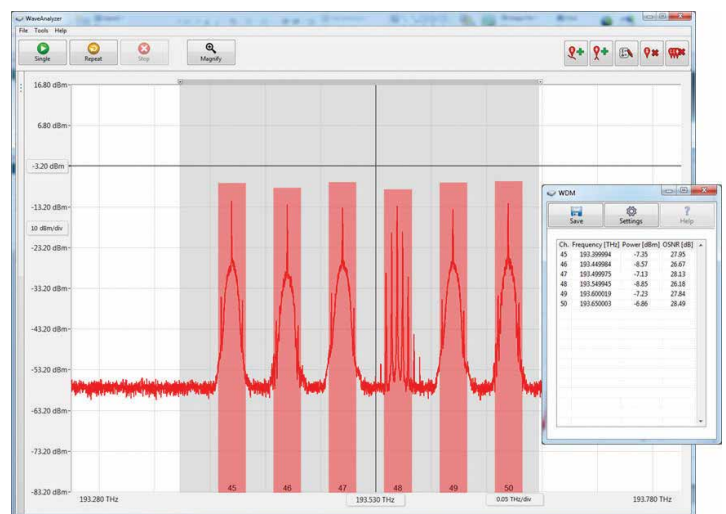

WDM channel analysis

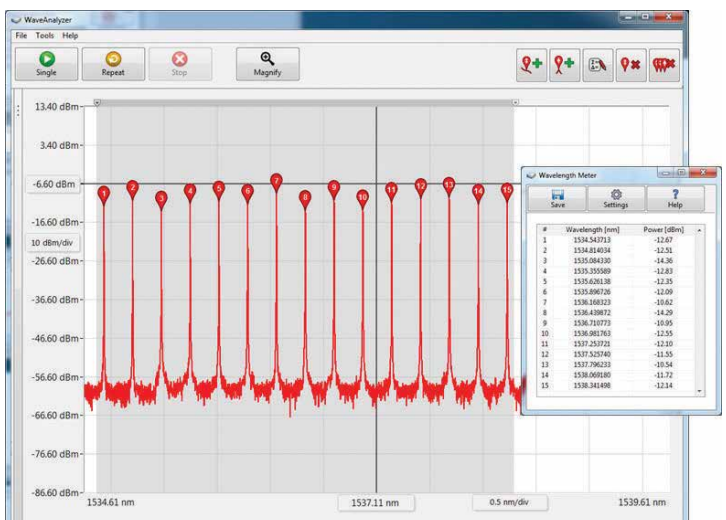

Wavelength Meter

Specifications

Specifications are guaranteed except where stated as typical (typ).

Spectral	Frequency Range	191.15 to 196.35 THz (1526.9 to 1568.5 nm)
	Spectral Sampling Resolution	20 MHz
	Resolution Bandwidth (FWHM)	180 MHz (typ.)
	Absolute Frequency Accuracy (1)	+/- 500 MHz
	Frequency Repeatability (sweep to sweep)	50 MHz
	Measurement Update Rate (2): full C-band scan Scan across any 200 GHz window	4 updates / s 10 updates / s
Power (3)	Max Total Power	23 dBm (3 dBm for "3 dBm max" optical input)
	Max Power Density	0 dBm / 20 MHz
	Relative Power Accuracy	+/-0.2 dB (4)
	Spurious Free Dynamic Range (1)	> 50 dB
	Close-In Dynamic Range (5)	> 38 dB @ +/- 2 GHz
Mechanical, Electrical and Environmental	Operating Temperature	15°C to 35°C
	Operating Humidity	10% to 85%
	Communications Interface	USB 2.0, Ethernet
	Trigger Input	TTL (SMA)
	Trigger Output	TTL (SMA)
	Power Consumption	100 V - 240 V; 20 VA
	Connector Type	FC/APC
	Size	241 mm x 88 mm x 316 mm
Weight	< 4 kg	

- Notes:**
1. Valid within recommended recalibration period
 2. Requires a PC with at least an i7 processor or equivalent and a Gigabit Ethernet connection
 3. Specifications valid on the "23 dBm max" optical port, except where stated differently
 4. Guaranteed when using an ASE source
 5. When measuring on one optical channel

Part Number	Description
WA-AA-1500S-ZZ-H	WaveAnalyzer 1500S, bench-top
WA-AA-1500S-RM-H	WaveAnalyzer 1500S, rack-mount

WaveAnalyzer Video on YouTube

Watch a live demo of the WaveAnalyzer on <https://www.finisar.com/technology/videos/finisar-waveanalyzer-video-demonstration-ecoc-2015>
Alternatively you may access the video by searching for "Finisar" and "WaveAnalyzer" on www.youtube.com. Finisar's YouTube channel is available at bit.ly/XdGnTg.



Technology Innovator.
Broad Product Portfolio.
Trusted Partner.

FINISAR[®]

1389 Moffett Park Drive
Sunnyvale, CA 94089-1133
www.finisar.com/waveanalyzer

Tel: +1 408-548-1000
Sales: +1 408-541-5690
Email: waveanalyzer@finisar.com



Scan this code to
access the website

©2016 Finisar Corporation. All rights reserved. Finisar is a registered trademark and WaveAnalyzer is a pending trademark of Finisar Corporation. Features and specifications are subject to change without notice. PG-WANL-1116

Компания «Life Electronics» занимается поставками электронных компонентов импортного и отечественного производства от производителей и со складов крупных дистрибьюторов Европы, Америки и Азии.

С конца 2013 года компания активно расширяет линейку поставок компонентов по направлению коаксиальный кабель, кварцевые генераторы и конденсаторы (керамические, пленочные, электролитические), за счёт заключения дистрибьюторских договоров

Мы предлагаем:

- Конкурентоспособные цены и скидки постоянным клиентам.
- Специальные условия для постоянных клиентов.
- Подбор аналогов.
- Поставку компонентов в любых объемах, удовлетворяющих вашим потребностям.
- Приемлемые сроки поставки, возможна ускоренная поставка.
- Доставку товара в любую точку России и стран СНГ.
- Комплексную поставку.
- Работу по проектам и поставку образцов.
- Формирование склада под заказчика.
- Сертификаты соответствия на поставляемую продукцию (по желанию клиента).
- Тестирование поставляемой продукции.
- Поставку компонентов, требующих военную и космическую приемку.
- Входной контроль качества.
- Наличие сертификата ISO.

В составе нашей компании организован Конструкторский отдел, призванный помогать разработчикам, и инженерам.

Конструкторский отдел помогает осуществить:

- Регистрацию проекта у производителя компонентов.
- Техническую поддержку проекта.
- Защиту от снятия компонента с производства.
- Оценку стоимости проекта по компонентам.
- Изготовление тестовой платы монтаж и пусконаладочные работы.



Тел: +7 (812) 336 43 04 (многоканальный)

Email: org@lifeelectronics.ru