

DPDT Coaxial Switches DC to 6 GHz, DC to 20 GHz, DC to 26.5 GHz, DC to 40 GHz

Radiall's PLATINUM SERIES switches are optimised to perform at a high level over an extended life span. With outstanding RF performances, and a guaranteed Insertion Loss repeatability of 0.03 dB over a life span of 10 million switching cycles. PLATINUM SERIES switches are perfect for automated test and measurement equipment, as well as signal monitoring devices.

PART NUMBER SELECTION

NEW

R 593 . 7 3 1 4 . .

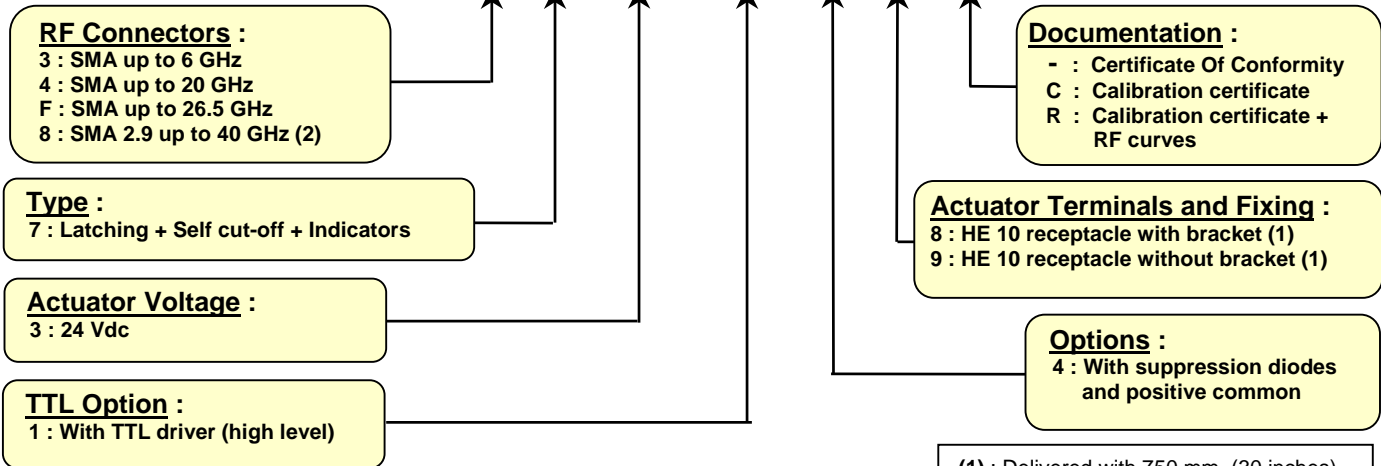

(1) : Delivered with 750 mm (30 inches) ribbon cable + HE10 connector

PICTURE



Note (2) : Connector SMA 2.9 is equivalent too "K connector®"
 ® : Registered trademark of Anritsu

In the continual goal to improve our products, we reserve the right to make any modification judged necessary

RF PERFORMANCES

PART NUMBER	R59337314-	R59347314-	R593F7314-	R59387314-
Frequency Range GHz	DC to 6	DC to 20	DC to 26.5	DC to 40
Impedance Ohms	50			
Insertion Loss dB (Maximum)	0.2 + 0.025 x frequency (GHz)			
Isolation dB (Minimum)	100	DC to 6 GHz : 100 6 to 12.4 GHz : 90 12.4 to 20 GHz : 80	DC to 6 GHz : 100 6 to 12.4 GHz : 90 12.4 to 20 GHz : 80 20 to 26.5 GHz : 65	DC to 6 GHz : 100 6 to 12.4 GHz : 90 12.4 to 20 GHz : 80 20 to 26.5 GHz : 65 26.5 to 40 GHz : 60
V.S.W.R. (Maximum)	1.20	DC to 6 GHz : 1.20 6 to 12.4 GHz : 1.25 12.4 to 18 GHz : 1.40 18 to 20 GHz : 1.65	DC to 6 GHz : 1.20 6 to 12.4 GHz : 1.25 12.4 to 18 GHz : 1.40 18 to 26.5 GHz : 1.65	DC to 6 GHz : 1.20 6 to 12.4 GHz : 1.25 12.4 to 18 GHz : 1.40 18 to 26.5 GHz : 1.65 26.5 to 40 GHz : 1.70
Repeatability (measured at 25°C)	0.03 dB			0.05 dB

TYPICAL RF PERFORMANCES

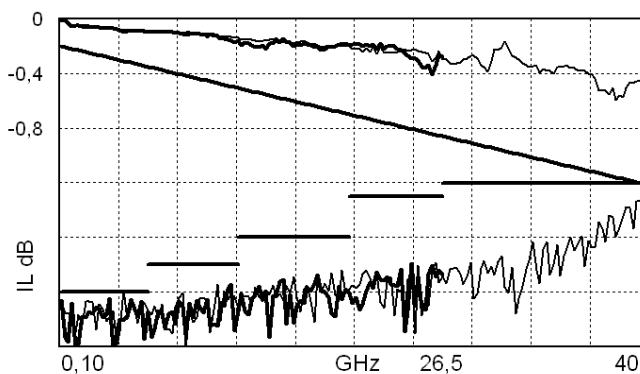

Insertion Loss and Isolation

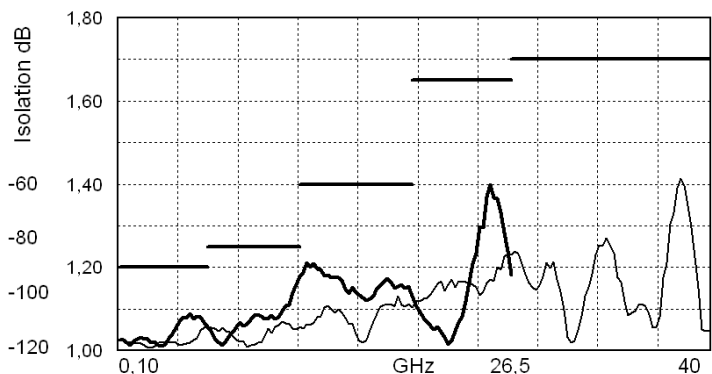

V.S.W.R.

: 26.5 GHz model with SMA /
 : 40 GHz

In the continual goal to improve our products, we reserve the right to make any modification judged necessary

ADDITIONAL SPECIFICATIONS

Operating mode		Latching	
Nominal operating voltage (across operating temperature) Vdc		24 (20 / 32)	
Coil resistance (+/-10%)	Ohms	120	
Nominal operating current at 23°C		200	
Maximum stand-by current		50	
Average power		RF path Cold switching : see Power Rating Chart on page 6 Hot switching : 1 Watt CW	
TTL input	High Level	3 to 7 V	1.4 mA max at 7 V
	Low Level	0 to 0.8 V	
Indicator specifications		Maximum withstanding voltage : 60V Maximum current capacity : 150 mA Maximum « ON » resistance : 2.5 Ω Minimum « OFF » resistance : 100 MΩ	
Switching time (max)		15	
Life (min) for	SMA	10 million cycles	
	SMA 2.9	5 million cycles	
Connectors		SMA – SMA 2.9	
Actuator terminal		HE10 ribbon receptacle	
Weight (max)	g	110	

ENVIRONMENTAL SPECIFICATIONS

Operating temperature range	°C	-25 to +75
Storage temperature range	°C	-55 to +85
Temperature cycling (MIL-STD-202 , Method 107D , Cond.A)	°C	-55 to +85 (10 cycles)
Vibration (MIL STD 202 , Method 204D , Cond.D)		10-2000 Hz , 10g operating
Shock (MIL STD 202 , Method 213B , Cond.C)		50g / 6 ms , ½ sine operating
Moisture resistance (MIL STD 202 , Method 106E , Cond.E)		65°C, 95% RH, 10 days
Altitude storage (MIL STD 202 , Method 105C , Cond.B)		50,000 feet (15,240 meters)
RFI (MIL STD 1344 , Method 3008 or IEC 61726)		40dB at 20GHz

In the continual goal to improve our products, we reserve the right to make any modification judged necessary

DRIVING THE SWITCH

There is two positions for a transfer switch. Each RF path can be closed by applying Ground or TTL "High" to the corresponding "drive" pin.

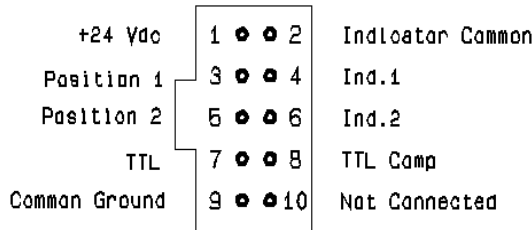

Switch connector

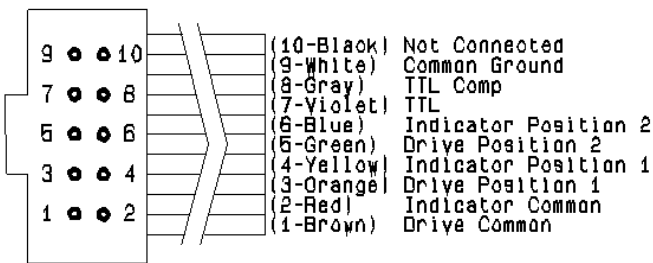

Mating cable connector

SCHEMATIC DIAGRAM

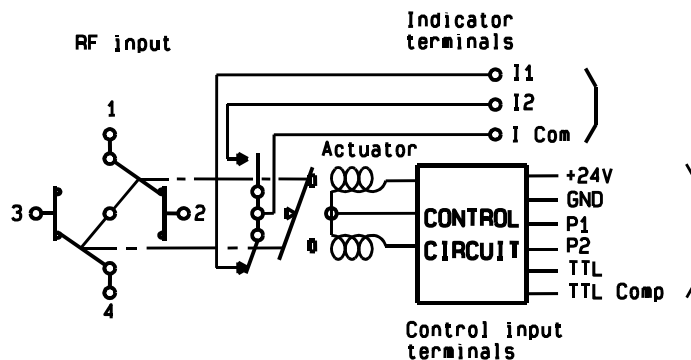

	RF continuity	Indicator
Position 1	1-2 / 3-4	ICom - I1
Position 2	1-3 / 2-4	ICom - I2

Standard drive

- Connect pin 9 to ground (See note 1).
- Connect pin 1 to supply (+20 VDC to +32 VDC)
- Select (close) desired RF paths by applying Ground to the corresponding "drive" pin (Ex: apply Ground to pin 3 to close RF path 1-2 and 3-4).
- To select the second path, ensure that unwanted RF path "drive" pin are disconnected from Ground. Apply Ground to the "drive" pin which corresponds to the desired RF paths (Ex: apply Ground to pin 5 to close RF path 1-3 and 2-4).

TTL drive (Dual line)

- Connect pin 9 to ground.
- Connect pin 1 to supply (+20 VDC to +32 VDC)
- Select (close) desired RF path by applying TTL "High" to the corresponding "drive" pin (Ex: apply TTL "High" to pin 7 and TTL "Low" to pin 8 to close RF paths position 1).
- To select the second path, ensure that unwanted RF path "drive" pins are in TTL "Low" position. Apply TTL "High" to the "drive" pin which correspond to the desired RF path and TTL "low" to the undesired. (Ex: apply TTL "High" to pin 8 and TTL "Low" to pin 7 to close RF paths position 2).

TTL drive (Single line)

- Connect pin 9 to ground.
- Connect pin 1 to supply (+20 VDC to +32 VDC)
- Connect pin 8 to TTL "High".
- Select (close) position 1 by applying TTL "High" to pin 7 (Ex: apply TTL "High" to pin 7 to close RF paths 1-2 and 3-4).
- Select position 2 by applying TTL "Low" to pin 7 (Ex: apply TTL "Low" to pin 7 to close RF paths 1-3 and 2-4).

Note 1

Pin 9 does not need to be grounded for the switch to operate in standard drive. If pin 9 is not grounded, the position indicators will only function while the appropriate drive has applied. Therefore, if a pulse drive is used and continuous indicator operation is required, pin 9 must be grounded.

In the continual goal to improve our products, we reserve the right to make any modification judged necessary

ELECTRONIC POSITION INDICATORS

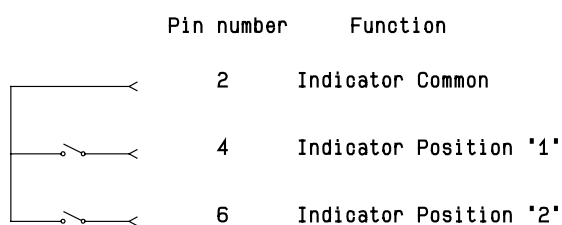

The electronic position indicators utilise photo-MOS transistors which are driven by the mechanical position of the RF paths moving elements. The circuitry consists of a common which can be connected to an output corresponding to selected RF path. The photo-MOS transistors are configured for AC and/or DC operation. The electronic position indicators require the supply (20 to 32 VDC) to be connected to pin 1 and ground connected to pin 9.

TYPICAL OUTLINE DRAWING

All dimensions are in millimetres/ inches.

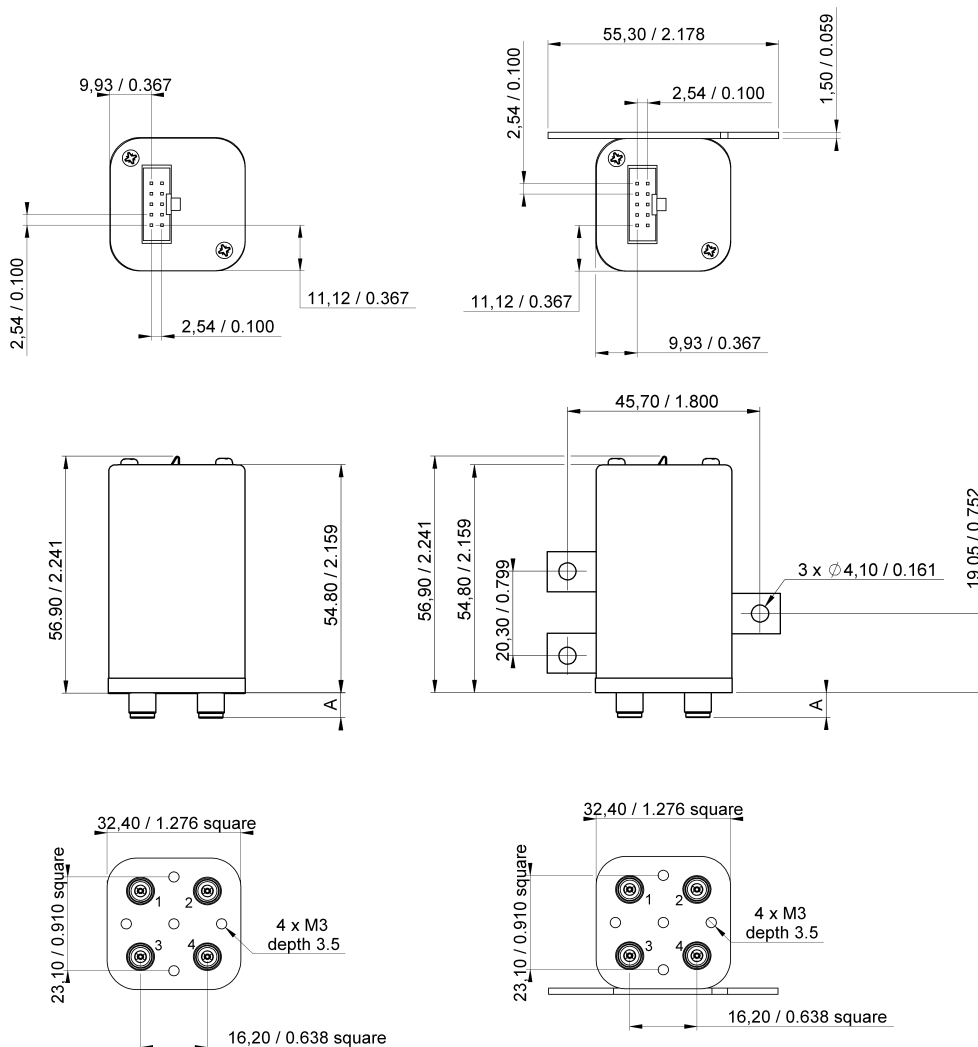

Connectors	SMA	SMA 2.9
A max (mm)	7.4	6.3

In the continual goal to improve our products, we reserve the right to make any modification judged necessary

POWER RATING CHART

This graph is based on the following conditions :

- Ambient temperature : + 25°C
- Sea level
- V.S.W.R. : 1 and cold switching

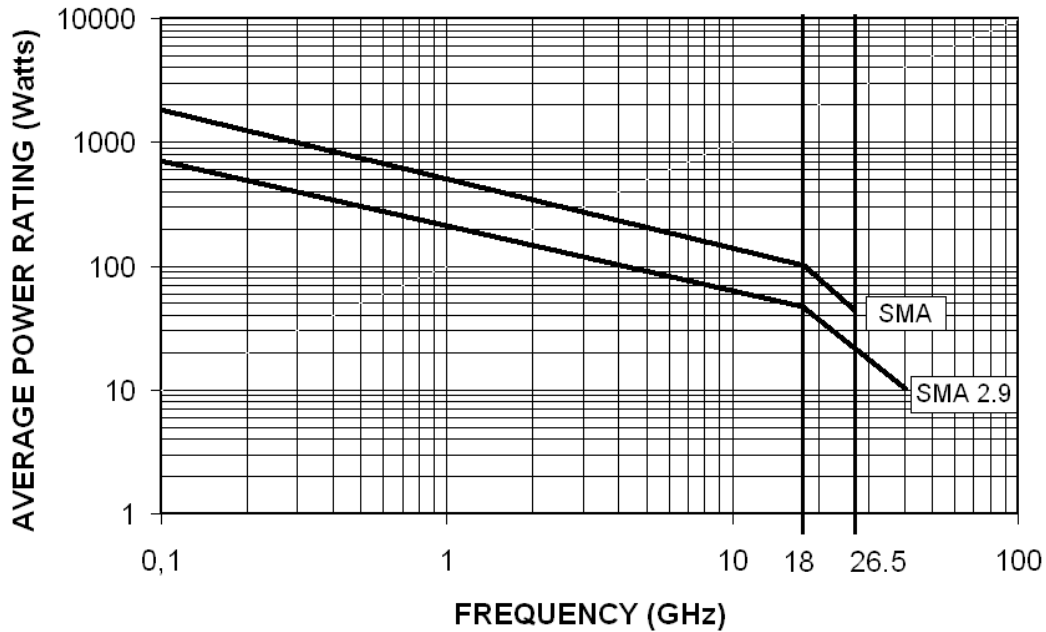

DERATING FACTOR VERSUS V.S.W.R.

The average power input must be reduced for load V.S.W.R. above 1.

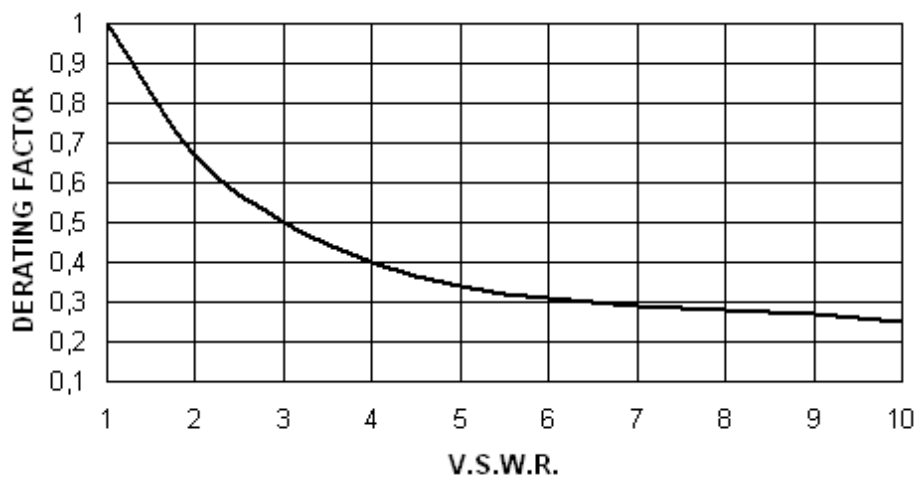

In the continual goal to improve our products, we reserve the right to make any modification judged necessary

Компания «Life Electronics» занимается поставками электронных компонентов импортного и отечественного производства от производителей и со складов крупных дистрибьюторов Европы, Америки и Азии.

С конца 2013 года компания активно расширяет линейку поставок компонентов по направлению коаксиальный кабель, кварцевые генераторы и конденсаторы (керамические, пленочные, электролитические), за счёт заключения дистрибьюторских договоров

Мы предлагаем:

- Конкурентоспособные цены и скидки постоянным клиентам.
- Специальные условия для постоянных клиентов.
- Подбор аналогов.
- Поставку компонентов в любых объемах, удовлетворяющих вашим потребностям.
- Приемлемые сроки поставки, возможна ускоренная поставка.
- Доставку товара в любую точку России и стран СНГ.
- Комплексную поставку.
- Работу по проектам и поставку образцов.
- Формирование склада под заказчика.
- Сертификаты соответствия на поставляемую продукцию (по желанию клиента).
- Тестирование поставляемой продукции.
- Поставку компонентов, требующих военную и космическую приемку.
- Входной контроль качества.
- Наличие сертификата ISO.

В составе нашей компании организован Конструкторский отдел, призванный помогать разработчикам, и инженерам.

Конструкторский отдел помогает осуществить:

- Регистрацию проекта у производителя компонентов.
- Техническую поддержку проекта.
- Защиту от снятия компонента с производства.
- Оценку стоимости проекта по компонентам.
- Изготовление тестовой платы монтаж и пусконаладочные работы.



Тел: +7 (812) 336 43 04 (многоканальный)

Email: org@lifeelectronics.ru