



SECTION 6

REED RELAYS FOR PRINTED
CIRCUIT BOARD APPLICATIONS
4 VA TO 100 VA
COAXIAL RELAYS
FOR R. F. SWITCHING



117SIP



L W H
0.290 x 0.280 x 0.750

107DIP



L W H
0.275 X 0.300 X 0.750

171DIP



L W H
0.275 X 0.300 X 0.750

RELAY SERIES

FEATURES

CONTACT DATA

CONTACT CONFIGURATION:

CONTACT MATERIAL:

CONTACT RESISTANCE:

MAX. SWITCHING LOAD:

CONTINUOUS CARRY CURRENT:

COIL DATA

STANDARD VOLTAGE DC:

NOMINAL COIL POWER WATTS:

GENERAL DATA

AMBIENT TEMPERATURE OPERATING:

STORAGE:

DIELECTRIC STRENGTH: (COIL TO FRAME)

LIFE EXPECTANCY

ELECTRICAL:
MECHANICAL:

PAGE NUMBER

- SPST - NO OR NC - EPOXY MOLDED CONSTRUCTION.
- STANDARD 0.1 GRID SPACING.
- AVAILABLE WITH OR WITHOUT SUPPRESSION DIODE ACROSS COIL.

- SPST - NO OR NC - EPOXY MOLDED CONSTRUCTION.
- STANDARD 0.1 GRID SPACING.
- 4 HOOK-UP PINS TO COIL & 4 HOOK-UP PINS TO CONTACTS
- AVAILABLE WITH OPTIONAL ELECTROSTATIC SHIELD

- SPST - NO OR NC - EPOXY MOLDED CONSTRUCTION.
- STANDARD 0.1 GRID SPACING.
- AVAILABLE WITH OR WITHOUT SUPPRESSION DIODE ACROSS COIL.
- AVAILABLE WITH OPTIONAL ELECTROSTATIC SHIELD

SPST-N. O., SPST-N. C.

RHODIUM

100 MILLIOHMS (INITIAL)

0.5 AMP, 200 VDC @ 10 VA

1.2 AMP

5, 12, 24,

50 - 290 mW MAX.

- 45°C TO + 85°C

- 40°C TO + 105°C

500 V rms

50,000,000 OPERATIONS
100,000,000 OPERATIONS

SPST-N. O., SPST-N. C.

RHODIUM

100 MILLIOHMS (INITIAL)

0.5 AMP, 100 VDC @ 10 VA

1.5 AMP

5, 12, 24,

35 - 290 mW MAX.

- 40°C TO + 85°C

- 40°C TO + 105°C

1000 V rms

50,000,000 OPERATIONS
100,000,000 OPERATIONS

SPST-N. O., SPST-N. C.

RHODIUM

100 MILLIOHMS (INITIAL)

0.5 AMP, 100 VDC @ 10 VA

1.5 AMP

5, 12, 24,

35 - 290 mW MAX.

- 40°C TO + 85°C

- 40°C TO + 105°C

1000 V rms

50,000,000 OPERATIONS
100,000,000 OPERATIONS



L W H
0.275 X 0.300 X 0.750

L W H
0.275 X 0.300 X 0.750/0.338 X 0.393 X 0.750

L W H
0.355 X 0.4 TO 0.9 X 1.15

- SPST - NO - EPOXY MOLDED CONSTRUCTION
- STANDARD 0.1 GRID SPACING
- DUAL OPERATE & RESET COIL
- MAINTAINS LAST SET CONTACT POSITION WITHOUT THE NEED FOR COIL POWER

- SPDT - EPOXY MOLDED CONSTRUCTION. DPDT - ENCAPSULATED CONSTRUCTION.
- STANDARD 0.1 GRID SPACING.
- AVAILABLE WITH SUPPRESSION DIODE ACROSS COIL.
- AVAILABLE WITH OPTIONAL ELECTROSTATIC SHIELD

- SPDT -NO, SPDT, DPST - NO & DPDT - DUST COVER STANDARD. ENCAPSULATED CONSTRUCTION OPTIONAL
- STANDARD 0.1 GRID OR OPTIONAL 0.15 GRID SPACING.
- UP TO 4PDT OR 6PST CONTACT ARRANGEMENTS.

SPST-N. O.

SPDT, DPDT

1 TO 4PDT, 1 TO 6PST

RHODIUM

RHODIUM

RHODIUM

100 MILLIOHMS (INITIAL)

100 MILLIOHMS (INITIAL)

200 MILLIOHMS (INITIAL)

0.5 AMP, 100 VDC @ 10 VA

SPDT: 0.25 AMP, 100 VDC @ 4 VA
DPDT: 0.5 AMP, 100 VDC @ 10 VA

MAX. SWITCHING
0.5 AMP OR 200 VDC
@ 10 VA

1.5 AMP

SPDT - 0.5 AMP, DPDT - 1.0 AMP

1.5 AMP

5, 12, 24,

5, 12, 24,

12, 24,

35 - 290 mW MAX.

35 - 290 mW MAX.

1030 mW MAX.

- 40°C TO + 85°C

- 40°C TO + 85°C

- 40°C TO + 85°C

- 40°C TO + 105°C

- 40°C TO + 105°C

- 40°C TO + 105°C

1000 V rms

1000 V rms

500 V rms

50,000,000 OPERATIONS
100,000,000 OPERATIONS

50,000,000 OPERATIONS
100,000,000 OPERATIONS

50,000 OPERATIONS
10,000,000 OPERATIONS

RELAY SERIES

134 MPCX
MERCURY
WETTED



102VX & 102HVX



120 COAXIAL



L W H
2.90 X 1.53 X 1.40

L W H
0.65 X 0.76 X 2.67

L W H
1.73 X 0.703 X 1.62

FEATURES

- SPDT & DPDT - DUST COVER STANDARD. ENCAPSULATED CONSTRUCTION OPTIONAL
- STANDARD 0.1 GRID OR OPTIONAL 0.15 SPACING AVAILABLE.
- POSITION SENSITIVE. VERTICAL MOUNTED.

- SPST - NO EPOXY ENCAPSULATED HIGH VOLTAGE REED
- SWITCHING UP TO 10 MA @ 5,000 VDC
5 MA @ 10,000 VDC

- SPDT - METAL CASE 150 WATT SWITCHING UP TO 470 MHz.
- RG58C/U CABLE, 12" LONG STANDARD. 50 OHM IMPEDANCE R.F. SWITCHING CONTACTS

CONTACT DATA

CONTACT CONFIGURATION:

SPDT, DPDT

SPST- N. O.

SPDT

CONTACT MATERIAL:

RHODIUM / MERCURY

TUNGSTEN

SILVER ALLOY GOLD FLASHED

CONTACT RESISTANCE:

100 MILLIOHMS (INITIAL)

200 MILLIOHMS (INITIAL)

50 MILLIOHMS (INITIAL)

MAX. SWITCHING LOAD:

MAX. SWITCHING
1.0 AMP OR 500 VDC @ 50 VA

VX-10 MA @ 5000VDC
HVX-5 MA @ 10,000 VDC

150 WATTS, 85 Vrms

CONTINUOUS
CARRY CURRENT:

30 & 15 MILLIAMPS

150 WATTS

COIL DATA

STANDARD VOLTAGE
DC:

5, 12, 24,

12, 24,

12

NOMINAL COIL POWER
WATTS:

620 mW MAX.

1.5 WATTS MAX.

1.44 WATTS MAX.

GENERAL DATA

AMBIENT TEMPERATURE
OPERATING:

- 37°C TO + 85°C

- 40°C TO + 85°C

- 55°C TO + 65°C

STORAGE:

- 40°C TO + 105°C

- 40°C TO +105°C

- 40°C TO +105°C

DIELECTRIC STRENGTH:
(COIL TO FRAME)

1000 V rms

12000 V rms

1500 V rms

LIFE EXPECTANCY

ELECTRICAL:
MECHANICAL:

40,000 OPERATIONS
10,000,000 OPERATIONS

1,000,000 OPERATIONS
10,000,000 OPERATIONS

5,000,000 OPERATIONS
100,000 OPERATIONS

HOW REED RELAYS WORK

The term reed relay covers dry reed relays and mercury-wetted contact relays, all of which use hermetically sealed reed switches. In both types, the reeds (thin, flat blades) serve multiple functions - as conductor, contacts, springs, and magnetic armatures.

DRY REED RELAYS

Dry reed relays have become an important factor in the relay field. They have the advantage of being hermetically sealed and resistant to atmospheric contamination. They have fast operate and release times and when operated within their rated contact loads, have very long life. A typical dry reed switch capsule is shown in Figure 1.



Figure 1. Construction of Switch Capsule of Typical Dry Reed switch (SPST-NO)

In the basic SPST-NO design, two opposing blades are sealed into a narrow glass capsule and overlapped at their free ends. The contact area is plated typically with rhodium to produce a low contact resistance when contacts are drawn together. The capsule is made of glass and filled with a dry inert gas and then sealed. The capsule is surrounded by an electromagnetic coil. When the coil is energized, the normally open contacts are brought together; when the coil voltage is removed, the blades separate by their own spring tension. Some reeds contain permanent magnets for magnetic biasing to achieve normally closed contacts (SPST-NC) or SPDT contact combinations. The current rating, which is dependent upon the size of the blade and the type and amount of plating, may range from low level to 1 amp. Effective contact protection is essential when switching loads other than dry resistive loads.

MERCURY-WETTED CONTACT RELAYS.

Mercury wetted contacts consist of a glass-encapsulated reed with its base immersed in a pool of mercury and the other end capable of moving between one or two stationary contacts. The mercury flows up the reed by capillary action and wets the contact surfaces of the moving end of the reed as well as the contact surfaces of the stationary contacts. A mercury to mercury contact is maintained in the closed position. The capsule is surrounded by an electromagnetic coil and operates in the same manner as a dry reed.



Figure 2. Miniature Mercury wetted contacts switch (SPST)

Mercury wetted contacts are fast in operation and have relatively good load carrying capacity and long life. The mercury films are reestablished at each contact closure and contact erosion is eliminated. The mercury films are stretchable, there is no contact bounce and because it is a mercury contact, the contact resistance is very low and ideal for low level switching applications. The disadvantages of this type of reed relay are the freezing point of mercury (-38°C), poor resistance to shock and vibration and the need to mount the relay in a near vertical position. These relays are used for a variety of switching applications such as found in computers, business machines, machine tool control systems, and laboratory instruments.

CONTACT COMBINATIONS.

The switches used in dry reed relays provide SPST-NO, SPST-NC, SPDT contact combinations.

The SPST-NO corresponds with the basic switch capsule design (Fig.1).

The SPST-NC results from a combination of the SPST-NO switch and a permanent magnet strong enough to pull the contacts closed but able to open when coil voltage is applied to the relay coil.

In typical true SPDT designs, the armature is mechanically tensioned against the normally closed contact, and is moved to the normally open contact upon application of a magnetic field. The SPDT contact combination can also be achieved by joining a SPST-NO switch with an appropriately adjusted SPST-NC switch, and jumping one side of both switches together to form the movable contact system.

Latching contacts, defined as contacts which remain in the position to which they were driven, and stay in that position when coil power is removed from the relay coil.

Latching switches are manufactured by using a SPST-NO contact, and biasing it with a permanent magnetic that is strong enough to hold the contacts closed, but not strong enough to hold the contact closed when coil power is applied to the coil. The switching process is then reversed by simply reversing the relay coil polarity to close the switch, or by employing a second coil with a reverse field.

APPLICATION DATA

MAGNETIC FIELDS

Reed relays in general can be characterized as susceptible to the influences of external magnetic fields. It is important to keep reed relays at a proper distance from each other because of the possibility of magnetic-interaction between them. Proper magnetic shielding must be used to contain stray magnetic fields. When installing reed relays into equipment, one should be aware of the devices within that equipment which can produce magnetic fields. The relays being installed into that equipment should be positioned as far away as possible from any stray magnetic fields and should be shielded to prevent false operations.

ELECTRICAL CHARACTERISTICS

SENSITIVITY:

The input power required to operate dry reed relays is determined by the sensitivity of the particular reed switch used, by the number of switches operated by the coil, by the permanent magnet biasing (if used), and the efficiency of the coil and the effectiveness of its coupling to the blades. Minimum input required to effect closure ranges from the very low milliwatt level for a single sensitive capsule to several watts for multipole relays.

OPERATE TIME:

The coil time constant, overdrive on the coil, and the characteristics of the reed switch determine operate time. With the maximum overdrive voltage applied to the coil, reed relays will operate in approximately the 200 microsecond range. When driven at rated coil voltage, usually the relays will operate at about one millisecond.

RELEASE TIME:

With the coil unsuppressed, dry reed switch contacts release in a fraction of a millisecond. SPST-NO contacts will open in as little as 50 microseconds. Magnetically biased SPST-NC and SPDT switches reclose from 100 microseconds to 1 millisecond respectively. If the relay coil is suppressed, release times are increased. Diode suppression can delay release times for several milliseconds, depending on coil characteristics, coil voltage, and reed release characteristics.

CONTACT BOUNCE

Dry reed contacts bounce on closure as with any other hard contact relay. The duration of bounce on a Dry reed switch is typically very short, and is in part dependent on drive level. In some of the faster devices, the sum of the operate time and bounce is relatively constant. As drive is increased, the operate time decreases with bounce time increasing. The normally closed contacts of a SPDT switch bounce more than the normally open contacts. Magnetically biased SPST-NC contacts exhibit essentially the same bounce characteristics as SPST-NO switches.

CONTACT RESISTANCE

The reeds (blades) in a dry reed switch are made of magnetic material which has a high volume resistivity, terminal-to-terminal resistance is somewhat higher than in some other types of relays. Typical specification limits for initial resistance of a SPST-NO reed relay is 0.200 ohms max (200 milliohms).

INSULATION RESISTANCE

A dry reed switch made in a properly controlled internal atmosphere will have an insulation resistance of 10^{12} to 10^{14} ohms or greater. When it is assembled into a relay, parallel insulation paths reduce this to typical values of 10^8 ohms. Depending on the particular manner of relay construction, exposure to high humidity or contaminating environments can appreciably lower final insulation resistance.

CAPACITANCE

Reed capsules typically have low terminal-to-terminal capacitance. However, in the typical relay structure where the switch is surrounded by a coil, capacitance from each reed to the coil act to increase capacitance many times. If the increased capacitance is objectionable, it can be reduced by placing a grounded electrostatic shield between the switch and coil.

DIELECTRIC WITHSTAND VOLTAGE

With the exception of the High-Voltage dry reed switches (capsules that are pressurized or evacuated), the dielectric strength limitation of relays is determined by the ampere turn sensitivity of the switches used. A typical limit is 200 VAC. The dielectric withstand voltage between switch and coil terminals is typically 500 VAC.



THERMAL EMF

Since thermally generated voltages result from thermal gradients within the relay assembly, relays built to minimize this effect often use sensitive switches to reduce required coil power, and thermally conductive materials to reduce temperature gradients. Latching relays, which may be operated by a short duration pulse, are often used if the operational rate is not changed for longer periods of time because coil power is not required to keep the relay in the on or off position after the initial turn on or turn off pulse.

NOISE

Noise is defined as a voltage appearing between terminals of a switch for a few milliseconds following closure of the contacts. It occurs because the reeds (blades) are moving in a magnetic field and because voltages are produced within them by magnetostrictive effects. From an application standpoint, noise is important if the signal switched by the reed is to be used within a few milliseconds immediately following closure of the contacts. When noise is critical in an application, a peak-to-peak limit must be established by measurement techniques, including filters which must be specified for that particular switching application.

ENVIRONMENTAL CHARACTERISTICS

Reed relays are used in essentially the same environments as other types of relays. Factors influencing their ability to function would be temperature extremes beyond specified limits

VIBRATION

The reed switch structure, with so few elements free to move, has a better defined response to vibration than other relay types. With vibration inputs reasonably separated from the resonant frequency, the reed relay will withstand relatively high inputs, 20 g's or more. At resonance of the reeds, the typical device can fail at very low input levels. Typical resonance frequency is 2000 hz.

SHOCK

Dry reed relays will withstand relatively high levels of shock. SPST-NO contacts are usually rated to pass 30 to 50 g's, 11 milliseconds, half sign wave shock, without false operation of contacts. Switches exposed to a magnetic field that keep the contacts in a closed position, such as in the biased latching form, demonstrate somewhat lower resistance to shock. Normally closed contacts of mechanically biased SPDT switches may also fail at lower shock levels.

TEMPERATURE

Differential expansion or contraction of reed switches and materials used in relay assemblies can lead to fracture of the switches. Reed relays are capable of withstanding temperature cycling or temperature shock over a range of at least -50°C to + 100°C. These limits should be applied to the application to prevent switch failure.

CONTACT PROTECTION

Tungsten lamp, inductive and capacitive discharge load are extremely detrimental to reed switches and reduce life considerably. Illustrated below are typical suppression circuits which are necessary for maximum contact life.



Figure 3

Initial cold filament turn-on current is often 16 times higher than the rated operating current of the lamp. A current limiting resistor in series with the load, or a bleeder resistor across the contacts will suppress the inrush current. The same circuits can be used with capacitive loads, as shown in Figure 3.



Figure 4

DC inductive loads call for either a diode or a thyristor to be placed across the load. These circuits are necessary to protect the contacts when inductive loads are to be switched in a circuit, as shown in Figure 4.

U. S. A.

TELEPHONE: (843)393-5778

FAX: (843)393-4123

WEBSITE: www.magnecraft.com

EMAIL: info@magnecraft.com

EUROPE

TELEPHONE: 4989 / 75080310

FAX: 4989/ 7559344

WEBSITE: www.magnecraft.com

EMAIL: renatesteinback@magnecraft.de



GENERAL SPECIFICATIONS

COIL

Pull-in Voltage:	85% of nominal voltage or less
Drop Out Voltage:	10% of nominal voltage or more
Max. Voltage:	110% of nominal voltage
Resistance:	±10% measured @ 25°C
Coil Power:	See chart
Duty:	Continuous

CONTACTS

Contact Material:	Rhodium
Contact Resistance:	200 milliohms max
Contact Rating:	0.5 amp 200 VDC (10VA) 1.2 amps max. Continuous carry current

TIMING

Operate time:	1 mS or less @ nominal voltage
Release time:	1 mS or less @ nominal voltage

DIELECTRIC STRENGTH

Across Open Contacts:	150 V rms
Between Mutually	
Insulation Points:	500 V rms
Insulation Resistance:	1000 megohms min. @ 500 VDC
Capacitance:	1.0 pf typical coil to contact

TEMPERATURE

Operating:	-40°C to +85°C @ rated operation
Storage:	-40°C to +105°C

SHOCK RESISTANCE

Operating:	50 g's
------------	--------

VIBRATION RESISTANCE

Operating:	20 g's, 40 Hz to 200 Hz
------------	-------------------------

LIFE EXPECTANCY

Electrical:	50,000,000 operations @ 5-10 V @ 10 mA
Mechanical:	100,000,000 operations @ no load

MISCELLANEOUS

Operating Position:	Any
Enclosure:	Epoxy molded
Weight:	1 gram approx.

WHEN SPACING SIP RELAYS, THE RELAYS REQUIRE 1/2 INCH SPACING FROM THE SIDE OF THE ADJACENT RELAYS.

OUTLINE DIMENSIONS
DIMENSIONS SHOWN IN INCHES & (MILLIMETERS).



WIRING DIAGRAMS (TOP VIEWED)	STANDARD PART NUMBERS	COIL MEASURED @ 25°C		
		NOMINAL INPUT VOLTAGE	NOMINAL RESISTANCE (OHMS)	NOMINAL POWER (mW)
SPST - N. O. 	W117SIP-1	5	500 Ω	50
	W117SIP-3	12	1000 Ω	144
	W117SIP-5	24	2000 Ω	288
SPST - N. C. 	W117SIP-22	5	500 Ω	50
	W117SIP-23	12	1200 Ω	120
	W117SIP-24	24	2200 Ω	270
SPST - N. O. WITH CLAMPING DIODE 	W117SIP-6	5	500 Ω	50
	W117SIP-8	12	1000 Ω	144
	W117SIP-10	24	2000 Ω	288
SPST - N. C. WITH CLAMPING DIODE 	W117SIP-18	5	500 Ω	50
	W117SIP-25	12	1200 Ω	120
	W117SIP-26	24	2200 Ω	220

GENERAL SPECIFICATIONS

COIL

Pull-in Voltage:	85% of nominal voltage or less
Drop Out Voltage:	10% of nominal voltage or more
Max. Voltage:	110% of nominal voltage
Resistance:	±10% measured @ 25°C
Coil Power:	See chart
Duty:	Continuous

CONTACTS

Contact Material:	Rhodium
Contact Resistance:	200 milliohms max.
Contact Rating:	0.5 amp 100 VDC (10VA) 1.5 amps max. Continuous carry current.

TIMING

Operate time:	1 mS or less @ nominal voltage.
Reset time:	1 mS or less @ nominal voltage.

DIELECTRIC STRENGTH

Across Open Contacts:	200 V rms
Between Mutually Insulation Points:	1000 V rms
Insulation Resistance:	1000 megohms min. @ 500 VDC
Capacitance:	2.0 pf typical contact to open contact

TEMPERATURE

Operating:	-40°C to +85°C @ rated operation
Storage:	-40°C to +105°C

SHOCK RESISTANCE

Operating:	50 g's
------------	--------

VIBRATION RESISTANCE

Operating	20 g's, 40 Hz to 200 Hz
-----------	-------------------------

LIFE EXPECTANCY

Electrical:	50,000,000 operations @ 5-10 V @ 10 mA
Mechanical:	100,000,000 operations @ no load

MISCELLANEOUS

Operating Position:	Any
Enclosure:	Epoxy molded
Weight:	1 gram approx.

WHEN SPACING DIP RELAYS, THE RELAYS REQUIRE 1/2 INCH SPACING FROM THE SIDE OF THE ADJACENT RELAYS.

OUTLINE DIMENSIONS
DIMENSIONS SHOWN IN INCHES & (MILLIMETERS).

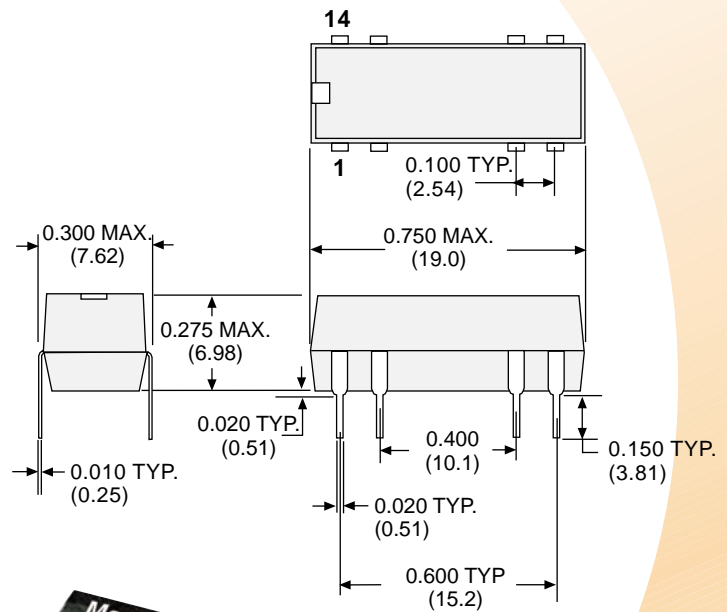

WIRING DIAGRAMS
(TOP VIEWED)

SPST - N. O.



STANDARD PART NUMBERS	COIL MEASURED @ 25°C		
	NOMINAL INPUT VOLTAGE	NOMINAL RESISTANCE (OHMS)	NOMINAL POWER (mW)
W107DIP-1	5	500 Ω	50
W107DIP-3	12	1000 Ω	144
W107DIP-4	24	2000 Ω	288
SPST - N. O. WITH CLAMPING DIODE			
W107DIP-5	5	500 Ω	50
W107DIP-7	12	1000 Ω	144
W107DIP-8	24	2000 Ω	288

SPST - N. O. WITH CLAMPING DIODE



SEE END OF SECTION 6 FOR CROSS REFERENCE

**SPST-N.O. OR N.C., DPST-N.O.
0.5 AMP**

GENERAL SPECIFICATIONS

COIL

Pull-in Voltage:	85% of nominal voltage or less
Drop Out Voltage:	10% of nominal voltage or more
Max. Voltage:	110% of nominal voltage
Resistance:	±10% measured @ 25°C
Coil Power:	See chart
Duty:	Continuous

CONTACTS

Contact Material:	Rhodium
Contact Resistance:	200 milliohms max.
Contact Rating:	0.5 amp 100 VDC (10VA) 1.5 amps max continuous carry current

TIMING

Operate time:	1 mS or less @ nominal voltage
Release time:	1 mS or less @ nominal Voltage

DIELECTRIC STRENGTH

Across Open Contacts:	150 V rms
Between Mutually Insulation Points:	500 V rms
Insulation Resistance:	1000 megohms min. @ 100 VDC
Capacitance:	1.0 pf typical contact to contact

TEMPERATURE

Operating:	-40°C to +85°C @ rated operation
Storage:	-40°C to +105°C

SHOCK RESISTANCE

Operating:	50 g's
------------	--------

VIBRATION RESISTANCE

Operating:	20 g's, 40 Hz to 200 Hz
------------	-------------------------

LIFE EXPECTANCY

Electrical:	50,000,000 operations @ rated load
Mechanical:	100,000,000 operations low level

MISCELLANEOUS

Operating Position:	Any
Enclosure:	Epoxy molded
Weight:	1 gram approx.

OUTLINE DIMENSIONS
DIMENSIONS SHOWN IN INCHES & (MILLIMETERS).

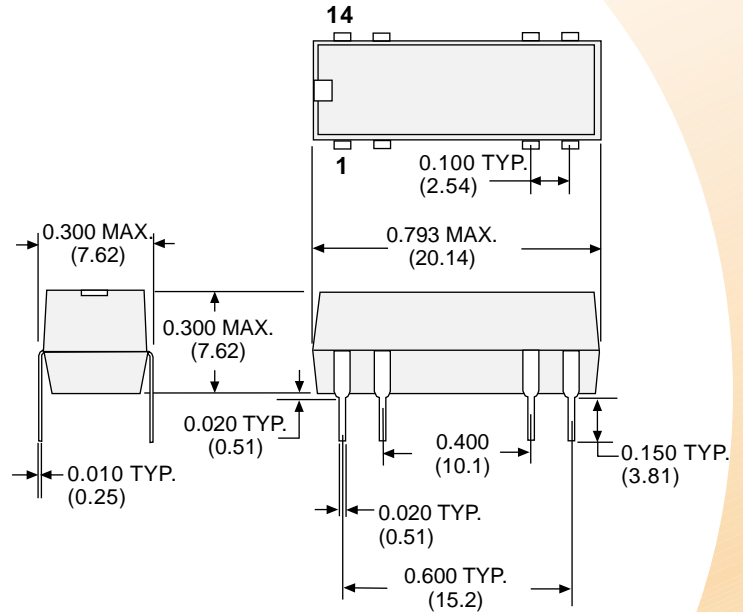

WHEN SPACING DIP RELAYS, THE RELAYS REQUIRE 1/2 INCH SPACING FROM THE SIDE OF THE ADJACENT RELAYS.

**SPST-N.O. OR N.C., DPST-N.O.
0.5 AMP**



WIRING DIAGRAMS (TOP VIEWED)	STANDARD PART NUMBERS	COIL MEASURED @ 25°C		
		NOMINAL INPUT VOLTAGE	NOMINAL RESISTANCE (OHMS)	NOMINAL POWER (mW)
SPST - N. O.				
	W171DIP-2	5	500 Ω	50
	W171DIP-4	12	1200 Ω	120
	W171DIP-5	24	2200 Ω	270
SPST - N. O. WITH CLAMPING DIODE				
	W171DIP-7	5	500 Ω	50
	W171DIP-9	12	1000 Ω	144
	W171DIP-10	24	2200 Ω	270
SPST - N. C.				
	W171DIP-12	5	200 Ω	50
	W171DIP-14	12	1200 Ω	120
	W171DIP-15	24	2200 Ω	270
SPST - N. C. WITH CLAMPING DIODE				
	W171DIP-17	5	500 Ω	50
	W171DIP-19	12	1200 Ω	120
	W171DIP-20	24	2200 Ω	270
DPST - N. O.				
	W171DIP-21	5	500 Ω	50
	W171DIP-23	12	1000 Ω	144
	W171DIP-24	24	2200 Ω	270
DPST - N. O. WITH CLAMPING DIODE				
	W171DIP-25	5	500 Ω	50
	W171DIP-27	12	1000 Ω	144
	W171DIP-28	24	2200 Ω	270



SEE END OF SECTION 6 FOR CROSS REFERENCE

SPST - N.O., 0.5 AMP

GENERAL SPECIFICATIONS

COIL

Pull-in Voltage:	85% of nominal voltage or less
Drop Out Voltage:	10% of nominal voltage or more
Max. Voltage:	110% of nominal voltage
Resistance:	±10% measured @ 25°C
Coil Power:	See chart
Duty:	Continuous

CONTACTS

Contact Material:	Rhodium
Contact Resistance:	200 milliohms max
Contact Rating:	0.5 amp 100 VDC (10VA) 1.5 amps max continuous carry current

TIMING

Operate time:	1 mS or less @ nominal voltage
Release time:	1 mS or less @ nominal Voltage

DIELECTRIC STRENGTH

Across Open Contacts:	150 V rms
Between Mutually Insulation Points:	500 V rms
Insulation Resistance:	1000 megohms min. @ 100 VDC
Capacitance:	1.0 pf typical contact to contact

TEMPERATURE

Operating:	-40°C to +85°C @ rated operation
Storage:	-40°C to +105°C

SHOCK RESISTANCE

Operating:	50 g's
------------	--------

VIBRATION RESISTANCE

Operating:	20 g's, 40 Hz to 200 Hz
------------	-------------------------

LIFE EXPECTANCY

Electrical:	50,000,000 operations @ rated load
Mechanical:	100,000,000 operations low level

MISCELLANEOUS

Operating Position:	Any
Enclosure:	Epoxy molded
Weight:	1 gram approx.

OUTLINE DIMENSIONS
DIMENSIONS SHOWN IN INCHES & (MILLIMETERS).

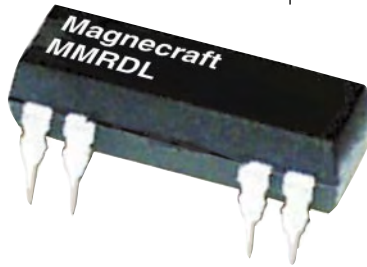

WHEN SPACING LATCHING DIP RELAYS, THE RELAYS REQUIRE 1 INCH SPACING BETWEEN ADJACENT RELAYS FROM END TO END.

WIRING DIAGRAMS (TOP VIEWED)

SPST - N. O.

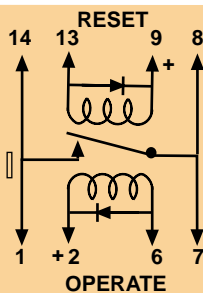

STANDARD PART NUMBERS

- MRRDL1AS8-5D
- MRRDL1AS8-12D
- MRRDL1AS8-24D

COIL MEASURED @ 25°C

NOMINAL INPUT VOLTAGE	NOMINAL RESISTANCE (OHMS)	NOMINAL POWER (mW)
5	750 / 750 Ω	35
12	1000 / 1000 Ω	145
24	4600 / 4600 Ω	125

GENERAL SPECIFICATIONS

COIL

Pull-in Voltage:	85% of nominal voltage or less
Drop Out Voltage:	10% of nominal voltage or more
Max. Voltage:	110% of nominal voltage
Resistance:	±10% measured @ 25°C
Coil Power:	See chart
Duty:	Continuous

CONTACTS

Contact Material:	Rhodium
Contact Resistance:	200 milliohms max
Contact Rating:	0.25 amp 100 VDC (4 VA) 0.5 amps max continuous carry current

TIMING

Operate time:	1 mS or less @ nominal voltage
Release time:	1 mS or less @ nominal Voltage

DIELECTRIC STRENGTH

Across Open Contacts:	1000 V rms
Between Mutually Insulation Points:	500 V rms
Insulation Resistance:	1000 megohms min. @ 100 VDC
Capacitance:	1.0 pf typical coil to contact

TEMPERATURE

Operating:	-40°C to +85°C @ rated operation
Storage:	-40°C to +105°C

SHOCK RESISTANCE

Operating:	50 g's
------------	--------

VIBRATION RESISTANCE

Operating:	20 g's, 40 Hz to 200 Hz
------------	-------------------------

LIFE EXPECTANCY

Electrical:	50,000,000 operations @ 50V/50mA
Mechanical:	80,000,000 operations low level 10V/10mA

MISCELLANEOUS

Operating Position:	Any
Enclosure:	Epoxy molded
Weight:	1 gram approx.

OUTLINE DIMENSIONS
DIMENSIONS SHOWN IN INCHES & (MILLIMETERS).



WHEN SPACING DIP RELAYS, THE RELAYS REQUIRE 1/2 INCH SPACING FROM THE SIDE OF THE ADJACENT RELAYS.



WIRING DIAGRAMS (TOP VIEWED)	STANDARD PART NUMBERS	COIL MEASURED @ 25°C		
		NOMINAL INPUT VOLTAGE	NOMINAL RESISTANCE (OHMS)	NOMINAL POWER (mW)
SPDT 	W172DIP-1	5	200 Ω	125
	W172DIP-3	12	500 Ω	300
	W172DIP-4	24	2200 Ω	270
SPDT WITH CLAMPING DIODE 	W172DIP-5	5	200 Ω	125
	W172DIP-7	12	500 Ω	300
	W172DIP-8	24	2200 Ω	270
SPDT 	W172DIP-31	5	200 Ω	125
	W172DIP-33	12	500 Ω	290
	W172DIP-34	24	2200 Ω	270
SPDT WITH CLAMPING DIODE 	W172DIP-35	5	200 Ω	125
	W172DIP-37	12	500 Ω	290
	W172DIP-38	24	2200 Ω	270
SPDT 	W172DIP-141	5	200 Ω	125
	W172DIP-145	12	1000 Ω	144
	W172DIP-146	24	3200 Ω	180
SPDT WITH CLAMPING DIODE 	W172DIP-147	5	200 Ω	125
	W172DIP-149	12	1000 Ω	144
	W172DIP-150	24	3200 Ω	180

SEE END OF SECTION 6 FOR CROSS REFERENCE



DPDT, 1.0 AMP

GENERAL SPECIFICATIONS

COIL

Pull-in Voltage:	85% of nominal voltage or less
Drop Out Voltage:	10% of nominal voltage or more
Max. Voltage:	110% of nominal voltage
Resistance:	±10 % measured @ 25°C
Coil Power:	See chart
Duty:	Continuous

CONTACTS

Contact Material:	Rhodium
Contact Resistance:	200 milliohms max.
Contact Rating:	0.25 amp 100 VDC (4 VA) 0.5 amps max continuous carry current.

TIMING

Operate time:	1 mS or less @ nominal voltage.
Release time:	1 mS or less @ nominal Voltage.

DIELECTRIC STRENGTH

Across Open Contacts:	1000 V rms
Between Mutually Insulation Points:	500 V rms
Insulation Resistance:	1000 megohms min. @ 100 VDC
Capacitance:	1.0 pf typical coil to contact

TEMPERATURE

Operating:	-40°C to +85°C @ rated operation
Storage:	-40°C to +105°C

SHOCK RESISTANCE

Operating:	50 g's
------------	--------

VIBRATION RESISTANCE

Operating:	20 g's, 40 Hz to 200 Hz
------------	-------------------------

LIFE EXPECTANCY

Electrical:	50,000,000 operations @ rated load
Mechanical:	100,000,000 operations low level

MISCELLANEOUS

Operating Position:	Any
Enclosure:	Epoxy molded
Weight:	1 gram approx.

WHEN SPACING DUAL IN - LINE REED RELAYS, THE RELAYS REQUIRE 1/2 INCH SPACING FROM THE SIDE OF THE ADJACENT RELAYS.

OUTLINE DIMENSIONS

DIMENSIONS SHOWN IN INCHES & (MILLIMETERS).

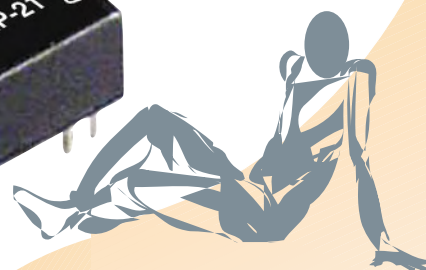

WIRING DIAGRAMS (TOP VIEWED)	STANDARD PART NUMBERS	COIL MEASURED @ 25°C		
		NOMINAL INPUT VOLTAGE	NOMINAL RESISTANCE (OHMS)	NOMINAL POWER (mW)
DPDT 	W172DIP-17	5	46 Ω	540
	W172DIP-19	12	266 Ω	540
	W172DIP-20	24	1066 Ω	540
DPDT WITH CLAMPING DIODE 	W172DIP-21	5	46 Ω	540
	W172DIP-23	12	266 Ω	540
	W172DIP-24	24	1066 Ω	540

SPDT - NO, SPDT, DPST-NO, DPDT, 0.5 AMP

PIN SPACING OF 0.100" IS STANDARD. PIN SPACING OF 0.150 IS AVAILABLE ON SPECIAL ORDER. ALSO AVAILABLE ARE MODELS WITH ELECTROSTATIC SHIELDS. CONSULT FACTORY FOR PART NUMBERS. NONSTANDARD SCHEMATICS AND PIN-OUTS CAN ALSO BE PRODUCED FOR SPECIFIC CUSTOMER REQUIREMENTS.

GENERAL SPECIFICATIONS

COIL	
Pull-in Voltage:	85% of nominal voltage or less
Drop Out Voltage:	10% of nominal voltage or more
Max. Voltage:	110% of nominal voltage
Resistance:	±10 % measured @ 25°C
Coil Power:	See chart
Duty:	Continuous

CONTACTS	
Contact Material:	Rhodium
Contact Resistance:	200 milliohms max.
Contact Rating:	10 VA -SPST - NO. & SPDT 4 VA -DPST - NO. & DPDT 0.5 amps max continuous carry current.

TIMING	
Operate time:	1 mS or less @ nominal voltage.
Release time:	1 mS or less @ nominal Voltage.

DIELECTRIC STRENGTH	
Across Open Contacts:	1000 VDC
Between Mutually Insulation Points:	1000 VDC
Insulation Resistance:	1000 megohms min. @ 100 VDC
Capacitance:	3 pf typical coil to contact

TEMPERATURE	
Operating:	-40°C to +85°C @ rated operation
Storage:	-40°C to +105°C

SHOCK RESISTANCE	
Operating:	50 g's

VIBRATION RESISTANCE	
Operating:	20 g's, 40 Hz to 200 Hz

LIFE EXPECTANCY	
Electrical:	10,000,000 operations @ rated load
Mechanical:	100,000,000 operations @ no load

MISCELLANEOUS	
Operating Position:	Any
Enclosure:	Epoxy encapsulated
Weight:	1 gram approx.

SIZE I



SIZE II

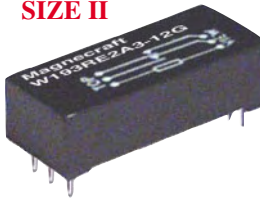

OUTLINE DIMENSIONS
DIMENSIONS SHOWN IN INCHES & (MILLIMETERS).

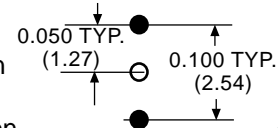
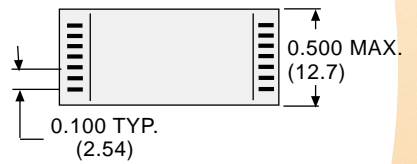
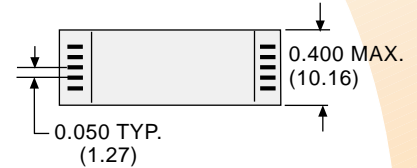
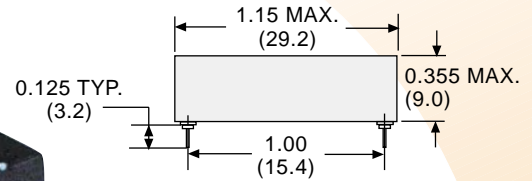

Spacing between filled in circles in schematics are on 0.100 grid patterns. Pin omitted on unfilled circles.



CASE SIZE	WIRING DIAGRAMS (TOP VIEWED)	STANDARD PART NUMBERS	COIL MEASURED @ 25°C		
			NOMINAL INPUT VOLTAGE	NOMINAL RESISTANCE (OHMS)	NOMINAL POWER (mW)
SPST - N. O.					
I		W193RE1A3-12G	12	420 Ω	350
		W193RE1A3-24G	24	2300 Ω	250
SPDT					
I		W193RE1C3-12G	12	420 Ω	350
		W193RE1C3-24G	24	2300 Ω	250
DPST - N. O.					
II		W193RE2A3-12G	12	280 Ω	500
		W193RE2A3-24G	24	1500 Ω	390
DPDT					
II		W193RE2C3-12G	12	280 Ω	500
		W193RE2C3-24G	24	1500 Ω	390

**3PST-N.O. 4PST-N.O.,
3PDT & 4PDT., 0.5 AMP**

SIZE III



SIZE IV



CASE SIZE	WIRING DIAGRAMS (TOP VIEWED)	STANDARD PART NUMBERS	COIL MEASURED @ 25°C		
			NOMINAL INPUT VOLTAGE	NOMINAL RESISTANCE (OHMS)	NOMINAL POWER (mW)
III	<p>3PST - N. O.</p>	W193RE3A3-12G	12	210 Ω	690
		W193RE3A3-24G	24	1150 Ω	500
III	<p>3PDT</p>	W193RE3C3-12G	12	210 Ω	690
		W193RE3C3-24G	24	1150 Ω	500
III	<p>4PST - N. O.</p>	W193RE4A3-12G	12	210 Ω	690
		W193RE4A3-24G	24	1150 Ω	500
IV	<p>4PDT</p>	W193RE4C3-12G	12	140 Ω	1030
		W193RE4C3-24G	24	770 Ω	750

WHEN SPACING MINIATURE REED RELAYS, THE RELAYS REQUIRE 1/2 INCH SPACING FROM THE SIDE OF THE ADJACENT RELAYS.

SPDT & DPDT, 2 AMP

PIN SPACING OF 0.100" IS STANDARD. PIN SPACING OF 0.150 IS AVAILABLE ON SPECIAL ORDER. ALSO AVAILABLE ARE MODELS WITH ELECTROSTATIC SHIELDS. CONSULT FACTORY FOR PART NUMBERS. NONSTANDARD SCHEMATICS AND PIN-OUTS CAN ALSO BE PRODUCED FOR SPECIFIC CUSTOMER REQUIREMENTS.

GENERAL SPECIFICATIONS

COIL	
Pull-in Voltage:	85% of nominal voltage or less
Drop Out Voltage:	10% of nominal voltage or more
Max. Voltage:	110% of nominal voltage
Resistance:	±10 % measured @ 25°C
Coil Power:	See chart
Duty:	Continuous

CONTACTS	
Contact Material:	Rhodium/Mercury
Contact Resistance:	100 milliohms max.
Contact Rating:	2 amp 500 VDC (50VA) 3 amps max continuous carry current.

TIMING	
Operate time:	2.0 mS or less @ nominal voltage.
Reset time:	2.5 mS or less @ nominal Voltage.

DIELECTRIC STRENGTH	
Across Open Contacts:	1000 VDC
Between Mutually Insulation Points:	1000 VDC
Insulation Resistance:	1000 megohms min. @ 100 VDC
Capacitance:	2.0 pf typical coil to contact

TEMPERATURE	
Operating:	-37°C to +85°C @ rated operation
Storage:	-40°C to +105°C

SHOCK RESISTANCE	
Operating:	50 g's

VIBRATION RESISTANCE	
Operating:	20 g's, 40 Hz to 200 Hz

LIFE EXPECTANCY	
Electrical:	50,000,000 operations @ rated load
Mechanical:	10,000,000 operations @ no load

MISCELLANEOUS	
Operating Position:	Vertical ±15%
Enclosure:	Epoxy encapsulated
Weight:	1 gram approx.

WHEN SPACING MINIATURE REED RELAYS, THE RELAYS REQUIRE 1/2 INCH SPACING FROM THE SIDE OF THE ADJACENT RELAYS.

OUTLINE DIMENSIONS

DIMENSIONS SHOWN IN INCHES & (MILLIMETERS).

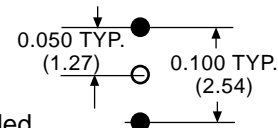
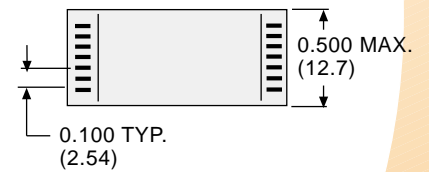
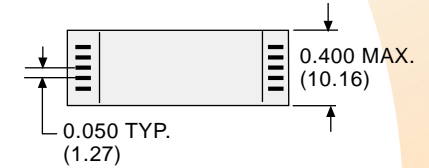
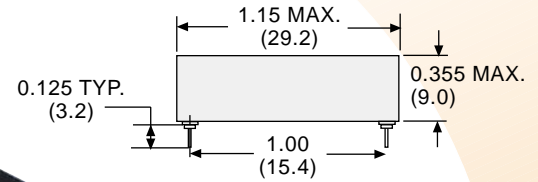

SIZE I

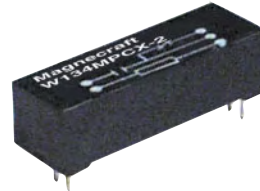

SIZE II

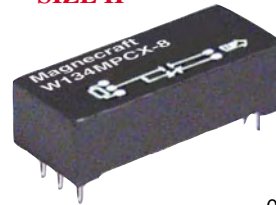

Spacing between filled in circles in schematics are on 0.100 grid patterns. Pin omitted on unfilled circles.



CASE SIZE	WIRING DIAGRAMS (TOP VIEWED)	STANDARD PART NUMBERS	COIL MEASURED @ 25°C		
			NOMINAL INPUT VOLTAGE	NOMINAL RESISTANCE (OHMS)	NOMINAL POWER (mW)
I		W134MPCX-2	12	330 Ω	435
		W134MPCX-3	24	1400 Ω	410
II		W134MPCX-8	12	230 Ω	620
		W134MPCX-11	12	230 Ω	620

**SPST - N.O.,
5 TO 10 MILLIAMPS**

**EPOXY ENCAPSULATED HIGH VOLTAGE REED.
SPST-NO TUNGSTEN CONTACTS
SWITCHES LOADS UP TO 10 MA @ 5000 VOLTS DC
CLASS 102HV SAME AS ABOVE EXCEPT:
SWITCHES 10,000 VOLTS WITH LOADS UP TO 5 mA DC**

GENERAL SPECIFICATIONS

COIL

Pull-in Voltage:	75% of nominal voltage or less
Drop Out Voltage:	10% of nominal voltage or more
Max. Voltage:	110% of nominal voltage
Resistance:	±10 % measured @ 25°C
Coil Power:	See chart
Duty:	Continuous

CONTACTS

Contact Material:	Tungsten
Contact Resistance:	200 milliohms max
Contact Rating:	10 ma 5000 VDC 5 ma @ 10,000 VDC

TIMING

Operate time:	1 mS or less @ nominal voltage
Release time:	1 mS or less @ nominal Voltage

DIELECTRIC STRENGTH

Across Open Contacts:	12,000 VDC
Between Mutually Insulation Points:	12,000 VDC
Insulation Resistance:	1000 megohms min. @ 500 VDC
Capacitance:	5 pf typical coil to contact

TEMPERATURE

Operating:	-40°C to +85°C @ rated operation
Storage:	-40°C to +105°C

SHOCK RESISTANCE

Operating:	30 g's, 11 mS, 1/2 sine wave
------------	------------------------------

VIBRATION RESISTANCE

Operating:	10 g's, 10 Hz to 1000 Hz
------------	--------------------------

LIFE EXPECTANCY

Electrical:	1,000,000 operations @ rated load
Mechanical:	10,000,000 operations @ no load

MISCELLANEOUS

Operating Position:	Any
Enclosure:	Epoxy encapsulated
Weight:	49 grams approx.

OUTLINE DIMENSIONS
DIMENSIONS SHOWN IN INCHES & (MILLIMETERS).

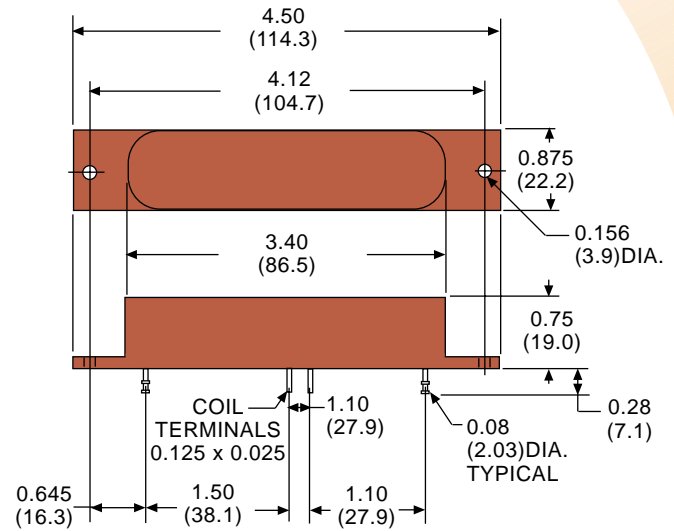

Do not use wire heavier than #22 AWG. Excess stress on terminals could cause damage to internal components



WIRING DIAGRAMS (TOP VIEWED)



COIL MEASURED @ 25°C

STANDARD PART NUMBERS	NOMINAL INPUT VOLTAGE	NOMINAL RESISTANCE (OHMS)	NOMINAL POWER (mW)
5,000 VOLTS NORMALLY OPEN			
W102VX-49	6 VDC	70 Ω	500 mW
W102VX-50	12 VDC	250 Ω	580 mW
W102VX-51	24 VDC	1000 Ω	580 mW
10,000 VOLTS NORMALLY OPEN			
W102HVX-3	24 VDC	400 Ω	1.5 Watts

SPDT, 150 WATTS

PANEL MOUNT WITH RG58C/U

CABLE (50 OHM)

SWITCHING 150 WATTS UP TO 470 MHz

GENERAL SPECIFICATIONS

COIL

Pull-in Voltage:	75% of nominal voltage or less
Drop Out Voltage:	10% of nominal voltage or more
Max. Voltage:	110% of nominal voltage
Resistance:	±10 % measured @ 25°C
Coil Power:	See chart
Duty:	Continuous

CONTACTS

Contact Material:	Silver alloy
Contact Resistance:	50 milliohms max. & rated load
Contact Rating:	150 watts 85 V rms

TIMING

Operate time:	15 mS or less @ nominal voltage.
Reset time:	7 mS or less @ nominal voltage.

DIELECTRIC STRENGTH

Across Open Contacts:	500 V rms
Between Mutually	
Insulation Points:	1000 V rms
Insulation Resistance:	1000 megohms min. @ 500 VDC
Capacitance:	30 pf maximum contact to open contact

TEMPERATURE

Operating:	-55°C to +65°C @ rated operation
Storage:	-55°C to +105°C

LIFE EXPECTANCY

Electrical:	5,000,000 operations @ rated load
Mechanical:	100,000 operations @ no load

MISCELLANEOUS

Operating Position:	Any
Enclosure:	Metal
Weight:	85 grams approx.

OUTLINE DIMENSIONS
DIMENSIONS SHOWN IN INCHES & (MILLIMETERS).

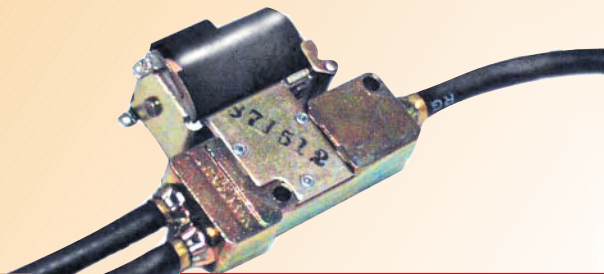
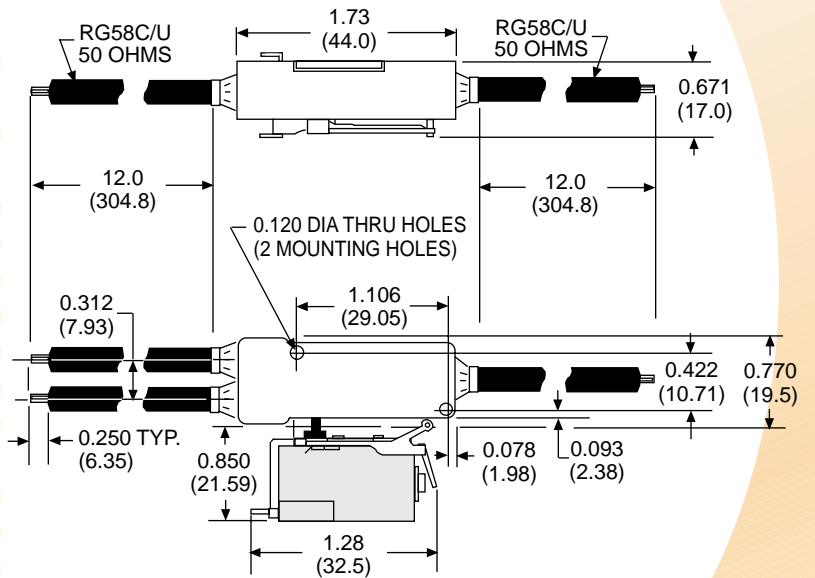

WIRING DIAGRAMS (SIDE VIEW COIL DOWN)	STANDARD PART NUMBERS	COIL MEASURED @ 25°C		
		NOMINAL INPUT VOLTAGE	NOMINAL RESISTANCE (OHMS)	NOMINAL POWER (mW)
<p>SPDT</p>	W120X-14	12 VDC	500 Ω	288



SECTION 6 CROSS REFERENCE GUIDE

MAGNECRAFT & STRUTHERS-DUNN	POTTER & BRUMFIELD	CLARE	COTO	COTO SPARTIN	GORDOS	HAMLIN	MEDER
W117SIP-1	JWS-117-1	DSS41A05	90010500		741A-9	3621A0500	SIL05-1A75-71L
W117SIP-3	JWS-117-3	DSS41A12	90011201		741A-3	3621A1200	SIL12-1A75-71L
W117SIP-5	JWS-117-5	DSS41A24			741A-7	3621A2400	SIL24-1A75-71L
W117SIP-22	JWS-117-12	DSS41B05			741B-3		
W117SIP-23	JWS-117-14	DSS41B12			741B-5		
W117SIP-24	JWS-117-15	DSS41B24			741B-8		
W117SIP-6	JWS-117-6	DSS41A05B			741B-10	3621A0510	SIL05-1A75-71D
W117SIP-8	JWS-117-8	DSS41A12B			741A-4	3621A1210	SIL12-1A75-71D
W117SIP-10	JWS-117-110	DSS41A24B			741A-8	3621A2410	SIL24-1A75-71D
W117SIP-18	JWS-117-17	DSS41B05B			741B-4		
W117SIP-25	JWS-117-19	DSS41B12B			741B-6		
W117SIP-26	JWS-117-30	DSS41B24B			741B-8		
MAGNECRAFT & STRUTHERS-DUNN	POTTER & BRUMFIELD	CLARE	COTO	COTO SPARTIN	GORDOS	HAMLIN	MEDER
W107DIP-1	JWD-107-1	PRMA10037			831A-3		DIP05-1A75-11L
W107DIP-3	JWD-107-3	PRMA10038			831A-5		DIP12-1A75-11L
W107DIP-4		PRMA10039			831A-7		DIP24-1A75-11L
W107DIP-5	JWD-107-5	PRMA10037B			831A-4		DIP05-1A75-11D
W107DIP-7	JWD-107-7	PRMA10038B			831A-6		DIP12-1A75-11D
W107DIP-8		PRMA10039B			831A-8		DIP24-1A75-11D
MAGNECRAFT & STRUTHERS-DUNN	POTTER & BRUMFIELD	CLARE	COTO	COTO SPARTIN	GORDOS	HAMLIN	MEDER
W171DIP-2		PRMA1A05	80010500	8L01-05-001	831A-3	721A0500	DIP05-1A75-11L
W171DIP-4		PRMA1A12	80011200	8L01-12-001	831A-5	721A1200	DIP12-1A75-11L
W171DIP-5	JWD-171-5	PRMA1A24		8L01-24-001	831A-7	721A2400	DIP24-1A75-11L
W171DIP-7		PRMA1A05B	80010510	8L01-05-011	831A-4	721A0510	DIP05-1A75-11D
W171DIP-9		PRMA1A12B	80011210	8L01-12-011	831A-6	721A1210	DIP12-1A75-11D
W171DIP-10	JWD-171-10	PRMA1A24B		8L01-24-011	831A-8	721A2410	DIP24-1A75-11D
W171DIP-12	JWD-171-12	PRMA1B05	80210500	8L21-05-001	831B-3	721B0500	DIP05-1B75-11L
W171DIP-14	JWD-171-14	PRMA1B12	80211200	8L21-12-001	831B-5	721B1200	DIP12-1B75-11L
W171DIP-15	JWD-171-15	PRMA1B24		8L21-24-001	831B-7	721B2400	DIP24-1B75-11L
W171DIP-17	JWD-171-17	PRMA1B05B	80210510	8L21-05-011	831B-4	721B0510	DIP05-1B75-11D
W171DIP-19	JWD-171-19	PRMA1B12B	80211210	8L21-12-011	831B-6	721B1210	DIP12-1B75-11D
W171DIP-20	JWD-171-20	PRMA1B24B		8L21-24-011	831B-8	721B2410	DIP24-1B75-11D
W171DIP-21	JWD-171-21	PRMA2A05	80020500	8L02-05-001	832A-3	722A0500	DIP05-2A75-21L
W171DIP-23	JWD-171-23	PRMA2A12	80021200	8L02-12-001	832B-5	722A1200	DIP12-2A75-21L
W171DIP-24	JWD-171-24	PRMA2A24		8L02-24-001	832B-7	722A2400	DIP24-2A75-21L
W171DIP-25	JWD-171-25	PRMA2A05B	80020510	8L02-05-011	832B-4	722A0510	DIP05-2A75-21D
W171DIP-27	JWD-171-27	PRMA2A12B	80021210	8L02-12-011	832B-6	722A1210	DIP12-2A75-21D
W171DIP-28	JWD-171-28	PRMA2A24B		8L02-24-011	831B-8	722A2410	DIP24-2A75-21D
MAGNECRAFT & STRUTHERS-DUNN	POTTER & BRUMFIELD				GORDOS		
W172DIP-1	JWD-172-1				836C-1	721R0500	
W172DIP-3	JWD-172-3				836C-3	721R1200	
W172DIP-4	JWD-172-4				836C-5	721R2400	
W172DIP-5	JWD-172-5				836C-2	721R0510	
W172DIP-7	JWD-172-7				836C-4	721R1210	
W172DIP-8	JWD-172-8				836C-6	721R2410	

THE CROSS REFERENCE IS INTENDED TO MATCH FOOT PRINT, INTERNAL WIRING, AND CONTACT LOAD RATINGS. CONSTRUCTION FEATURES AND GENERAL SPECIFICATIONS SHOULD BE COMPARED IF EXACT REPLACEMENT IS REQUIRED.



SECTION 6 CROSS REFERENCE GUIDE

MAGNECRAFT & STRUTHERS-DUNN	POTTER & BRUMFIELD	GORDOS	HAMLIN	MEDER	CLARE	COTO
W172DIP-17		835C-1				
W172DIP-19		835C-3				
W172DIP-20		835C-5				
W172DIP-21		835C-2				
W172DIP-23		835C-4				
W172DIP-24		835C-6				
W172DIP-141	JWD-172-155	831C-1	721C0500	DIP05-1C75-51L	PRMA1C05	80410500
W172DIP-145	JWD-172-157	831C-3	721C1200	DIP12-1C75-51L	PRMA1C12	80411200
W172DIP-146	JWD-172-158	831C-5	721C2400	DIP24-1C75-51L	PRMA1C24	
W172DIP-147	JWD-172-159	831C-2	721C0510	DIP05-1C75-51D	PRMA1C05B	80410510
W172DIP-149	JWD-172-161	831C-4	721C1210	DIP12-1C75-51D	PRMA1C12B	80411210
W172DIP-150	JWD-172-162	831C-6	721C2410	DIP24-1C75-51D	PRMA1C24B	
W172DIP-31		831C-1	721E0500			80510500
W172DIP-33		831C-3	721E1200			80511200
W172DIP-34		831C-5	721E2400			
W172DIP-35			721E0510			80510510
W172DIP-37			721E1210			80511210
W172DIP-38			721E2410			

THE CROSS REFERENCE IS INTENDED TO MATCH FOOT PRINT, INTERNAL WIRING, AND CONTACT LOAD RATINGS. CONSTRUCTION FEATURES AND GENERAL SPECIFICATIONS SHOULD BE COMPARED IF EXACT REPLACEMENT IS REQUIRED.

FOR REED RELAY APPLICATION ENGINEERING ASSISTANCE

Joseph Zintel, PRODUCT MANAGER

FAX: (843) 395-8530

EMAIL: jzintel@magnecraft.com

FAX ON DEMAND: 1-800-891-2957

DOCUMENT: 500

U. S. A.

TELEPHONE: (843) 393-5778

FAX: (843) 393-4123

WEBSITE: www.magnecraft.com

EMAIL: info@magnecraft.com

EUROPE

TELEPHONE: 4989 / 75080310

FAX: 4989 / 7559344

WEBSITE: www.magnecraft.com

EMAIL: renatesteinback@magnecraft.de



Компания «Life Electronics» занимается поставками электронных компонентов импортного и отечественного производства от производителей и со складов крупных дистрибьюторов Европы, Америки и Азии.

С конца 2013 года компания активно расширяет линейку поставок компонентов по направлению коаксиальный кабель, кварцевые генераторы и конденсаторы (керамические, пленочные, электролитические), за счёт заключения дистрибьюторских договоров

Мы предлагаем:

- Конкуренеспособные цены и скидки постоянным клиентам.
- Специальные условия для постоянных клиентов.
- Подбор аналогов.
- Поставку компонентов в любых объемах, удовлетворяющих вашим потребностям.
- Приемлемые сроки поставки, возможна ускоренная поставка.
- Доставку товара в любую точку России и стран СНГ.
- Комплексную поставку.
- Работу по проектам и поставку образцов.
- Формирование склада под заказчика.
- Сертификаты соответствия на поставляемую продукцию (по желанию клиента).
- Тестирование поставляемой продукции.
- Поставку компонентов, требующих военную и космическую приемку.
- Входной контроль качества.
- Наличие сертификата ISO.

В составе нашей компании организован Конструкторский отдел, призванный помогать разработчикам, и инженерам.

Конструкторский отдел помогает осуществить:

- Регистрацию проекта у производителя компонентов.
- Техническую поддержку проекта.
- Защиту от снятия компонента с производства.
- Оценку стоимости проекта по компонентам.
- Изготовление тестовой платы монтаж и пусконаладочные работы.



Тел: +7 (812) 336 43 04 (многоканальный)

Email: org@lifeelectronics.ru