

ALMD-LL36, ALMD-LG36, ALMD-LM36, ALMD-LB36

High Brightness SMT Oval LED Lamps

Amber, Red, Green and Blue



Data Sheet



Lead (Pb) Free
RoHS 6 fully
compliant



Description

The Avago ALMD-Lx36 oval LED series has the same or just slightly less luminous intensity than conventional high brightness, through-hole LEDs.

The new oval LED lamps can be assembled using common SMT assembly processes and are compatible with industrial reflow soldering processes.

The LEDs are made with an advanced optical grade epoxy for superior performance in outdoor sign applications. The surface mount Oval LEDs are specifically designed for full color/video signs and indoor or outdoor passenger information sign applications.

For easy pick-and-place assembly, the LEDs are shipped in EIA-compliant tape and reel. Every reel is shipped from a single intensity and color bin—except the red color—for better uniformity.

Package Dimensions

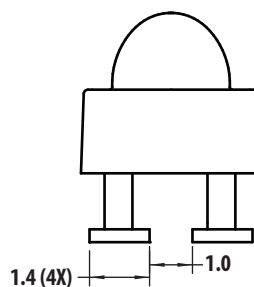
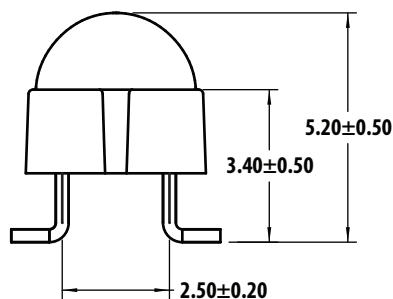
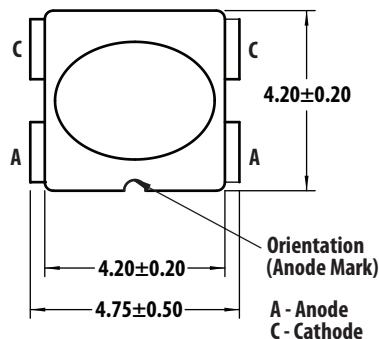

Features

- Well defined spatial radiation pattern
- High brightness material
- Available in Red, Amber, Green and Blue color:
 - Red AlInGaP 626 nm
 - Amber AlInGaP 590 nm
 - Green InGaN 525 nm
 - Blue InGaN 470 nm
- JEDEC MSL 2A
- Compatible with reflow soldering process
- Tinted and diffused lens
- Wide viewing angle: 40° x 100°

Applications

- Full color signs
- Mono color signs

Notes:

1. All dimensions in millimeters (inches).
2. Tolerance is ± 0.20 mm unless other specified.

CAUTION: InGaN devices are Class 1C HBM ESD sensitive, AlInGaP devices are Class 1B ESD sensitive per JEDEC Standard. Please observe appropriate precautions during handling and processing. Refer to Application Note AN-1142 for additional details.

CAUTION: Customer is advised to keep the LED in the MBB when not in use as prolonged exposure to environment might cause the silver plated leads to tarnish, which might cause difficulties in soldering.

Device Selection Guide

Part Number	Color and Dominant Wavelength λ_d (nm) Typ	Luminous Intensity I_v (mcd) [1,2,5]		Viewing Angle Typ - ° [4]
		Min	Max	
ALMD-LG36-WZ002	Red 626	1380	2900	40° x 100°
ALMD-LL36-WZ002	Amber 590	1380	2900	40° x 100°
ALMD-LM36-14002	Green 525	2900	6050	40° x 100°
ALMD-LB36-SV002	Blue 470	660	1380	40° x 100°

Notes:

1. The luminous intensity is measured on the mechanical axis of the lamp package and it is tested with pulsing condition.
2. The optical axis is closely aligned with the package mechanical axis.
3. Dominant wavelength, λ_d , is derived from the CIE Chromaticity Diagram and represents the color of the lamp.
4. $\theta_{1/2}$ is the off-axis angle where the luminous intensity is half the on-axis intensity.
5. Tolerance for each bin limit is $\pm 15\%$

Part Numbering System

ALMD - X X 3 6 - x x x xx

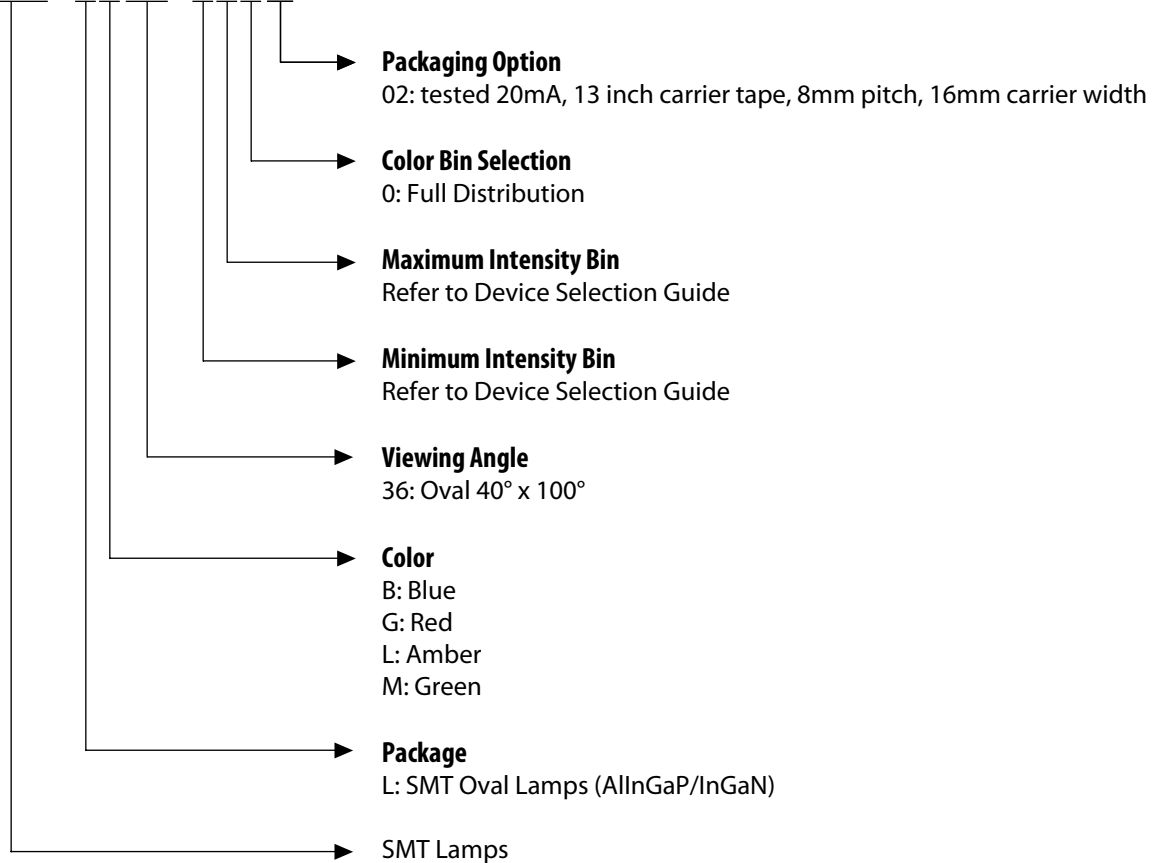

Absolute Maximum Rating, $T_J = 25\text{ }^\circ\text{C}$

Parameter	Red and Amber	Blue and Green	Unit
DC Forward Current ^[1]	50	30	mA
Peak Forward Current	100 ^[2]	100 ^[3]	mA
Power Dissipation	120	114	mW
Reverse Voltage	5 ($I_R = 100\ \mu\text{A}$) ^[4]	5 ($I_R = 10\ \mu\text{A}$) ^[4]	V
LED Junction Temperature	110		$^\circ\text{C}$
Operating Temperature Range	-40 to +85		$^\circ\text{C}$
Storage Temperature Range	-40 to +100		$^\circ\text{C}$

Notes:

1. Derate linearly as shown in Figure 4 and Figure 9.
2. Duty Factor 30%, frequency 1 kHz.
3. Duty Factor 10%, frequency 1 kHz.
4. Indicates product final testing; long-term reverse bias is not recommended.

Electrical / Optical Characteristics, $T_J = 25\text{ }^\circ\text{C}$

Parameter	Symbol	Min.	Typ.	Max.	Units	Test Conditions
Forward Voltage	V_F				V	$I_F = 20\ \text{mA}$
Red		1.8	2.1	2.4		
Amber		1.8	2.1	2.4		
Green		2.8	3.2	3.8		
Blue		2.8	3.2	3.8		
Reverse Voltage	V_R				V	$I_F = 100\ \mu\text{A}$
Red & Amber		5				$I_F = 10\ \mu\text{A}$
Green & Blue		5				
Dominant Wavelength ^[1]	λ_d					$I_F = 20\ \text{mA}$
Red		618.0	626.0	630.0		
Amber		584.5	590.0	594.5		
Green		519.0	525.0	539.0		
Blue		460.0	470.0	480.0		
Peak Wavelength	λ_{PEAK}				nm	Peak of Wavelength of Spectral Distribution at $I_F = 20\ \text{mA}$
Red			634			
Amber			594			
Green			516			
Blue			464			
Thermal Resistance	$R\theta_{J-PIN}$		130		$^\circ\text{C}/\text{W}$	LED Junction-to-Pin
Luminous Efficacy ^[2]	η_V				lm/W	Emitted Luminous Power/Emitted Radiant Power
Red			200			
Amber			520			
Green			530			
Blue			65			
Thermal coefficient of λ_d					nm/ $^\circ\text{C}$	$I_F = 20\ \text{mA}; +25\text{ }^\circ\text{C} \leq T_J \leq +100\text{ }^\circ\text{C}$
Red			0.059			
Amber			0.103			
Green			0.028			
Blue			0.024			

Notes:

1. The dominant wavelength is derived from the Chromaticity Diagram and represents the color of the lamp.
2. The radiant intensity, I_e in watts per steradian, may be found from the equation $I_e = I_V/\eta_V$ where I_V is the luminous intensity in candelas and η_V is the luminous efficacy in lumens/watt.

AlInGaP

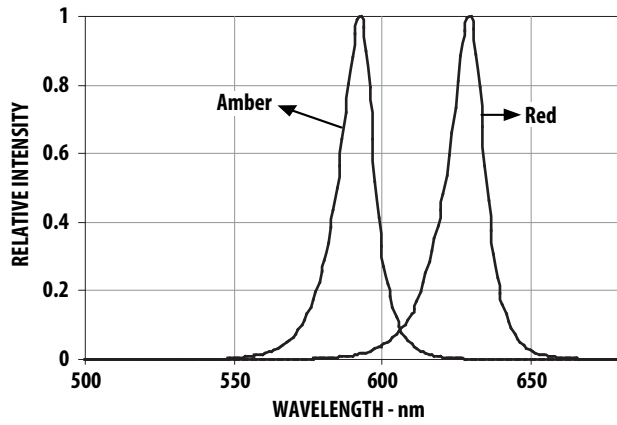

Figure 1. Relative Intensity vs Wavelength

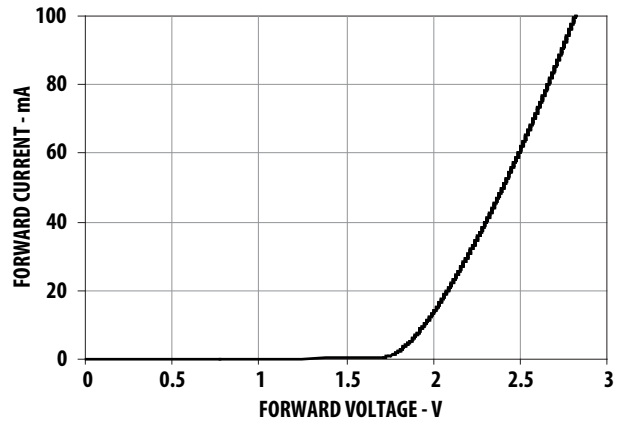

Figure 2. Forward Current vs Forward Voltage

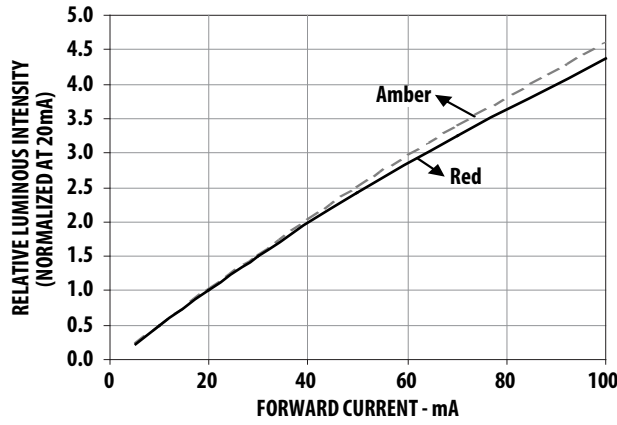
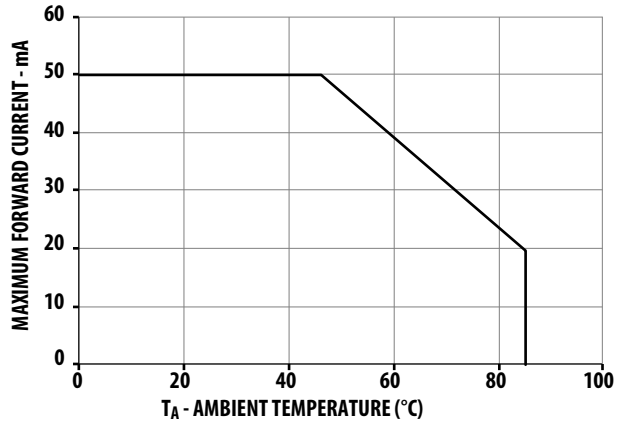

Figure 3. Relative Intensity vs Forward Current



Note: $R\theta_{J-A} = 460\text{ }^{\circ}\text{C/W}$

Figure 4. Maximum Forward Current vs Ambient Temperature

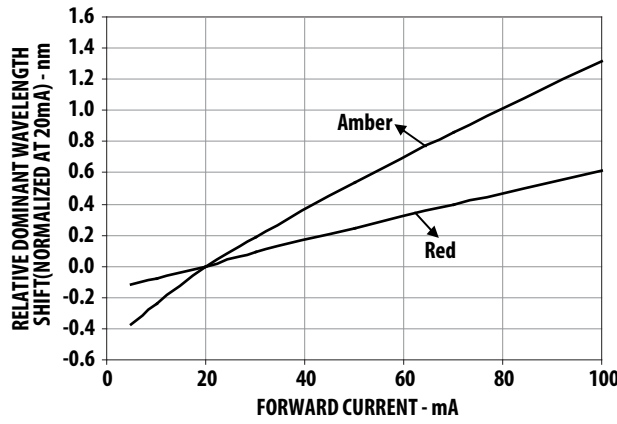

Figure 5. Relative Dominant Wavelength Shift vs Forward Current

InGaN

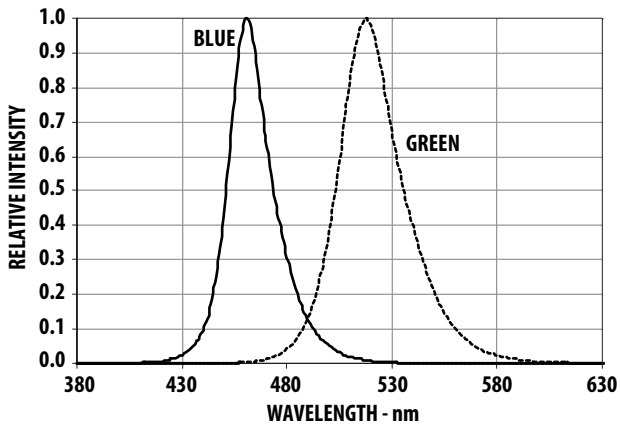

Figure 6. Relative Intensity vs Wavelength

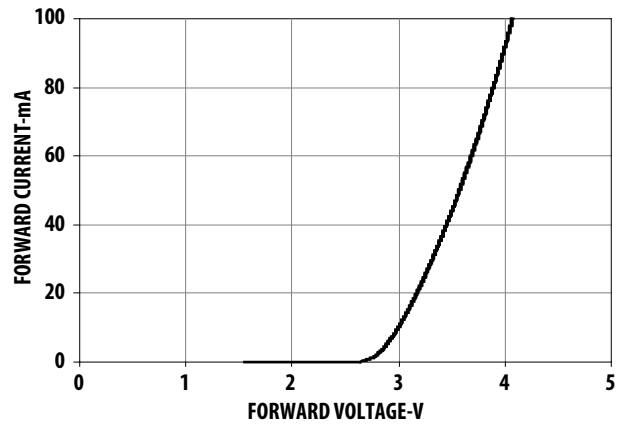

Figure 7. Forward Current vs Forward Voltage

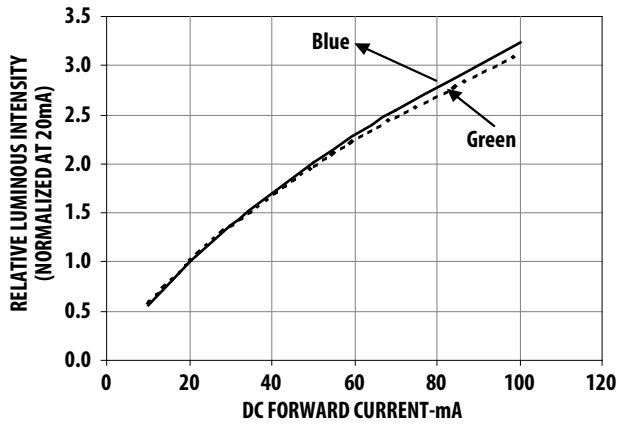

Figure 8. Relative Intensity vs Forward Current

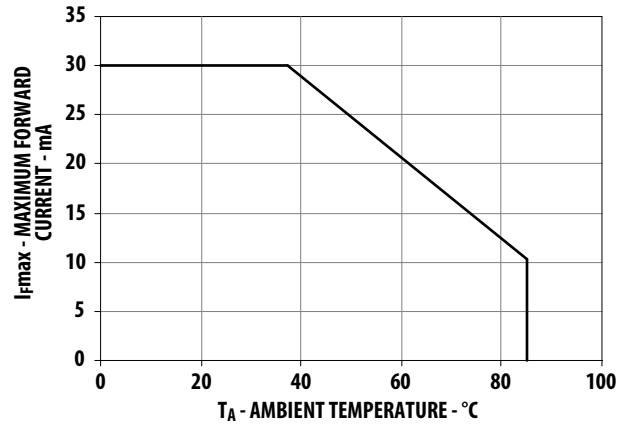

Figure 9. Maximum Forward Current vs Ambient Temperature

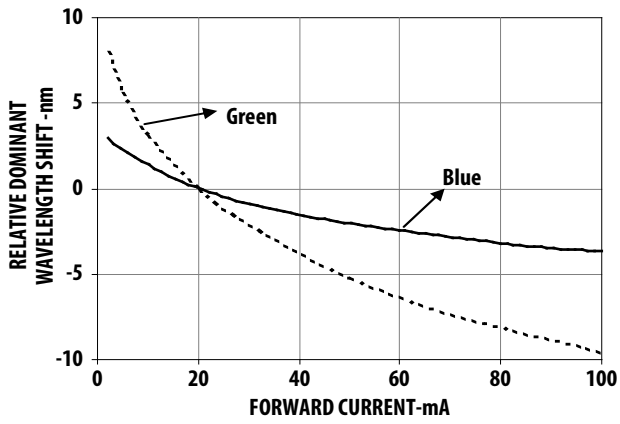

Figure 10. Dominant Wavelength Shift vs Forward Current

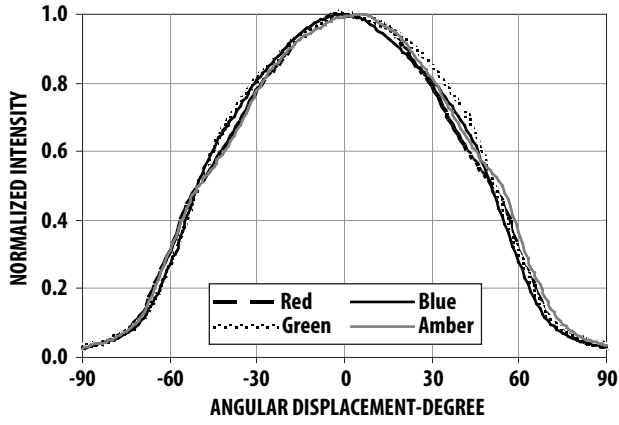

Figure 11a. Radiation Pattern for Major Axis

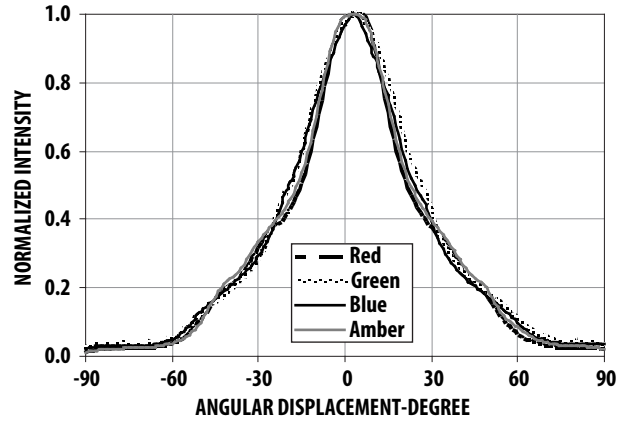

Figure 11b. Radiation Pattern for Minor Axis

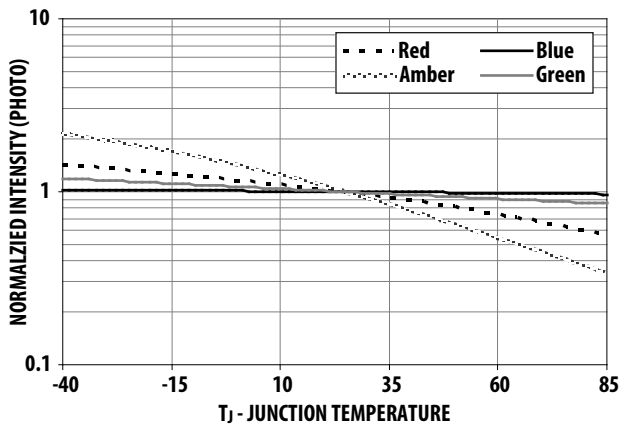

Figure 12. Relative Intensity Shift vs Junction Temperature

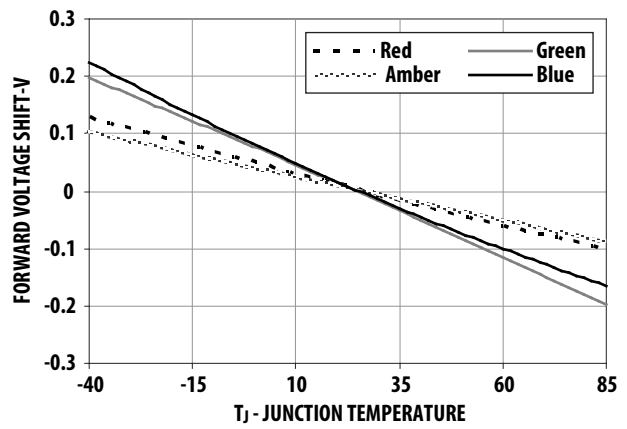

Figure 13. Forward Voltage Shift vs Junction Temperature

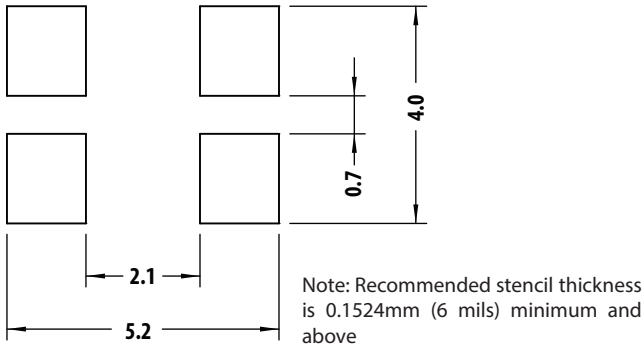
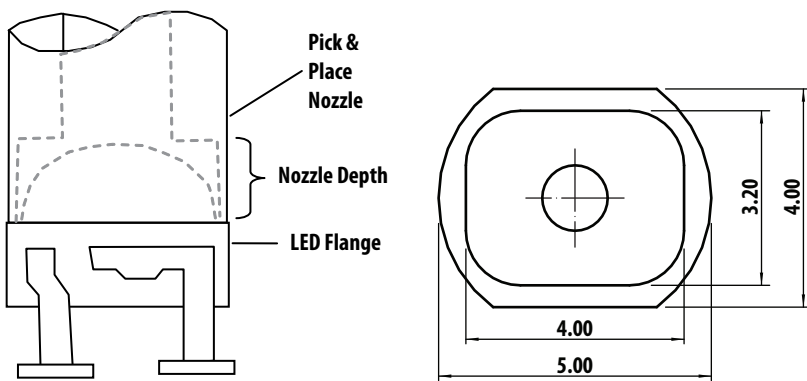

Figure 14. Recommended Soldering Land Pattern



Note:

1. Nozzle depth should be touching LED flange during pick and place.
2. Nozzle width should be able to fit into LED carrier tape

Figure 15. Recommended Pick and Place Nozzle Tip (Urethane PAD Tip)

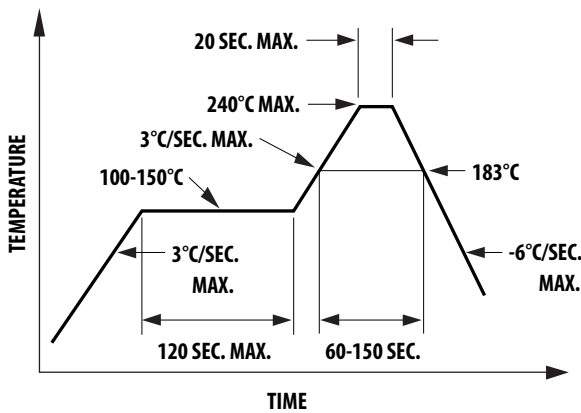

Figure 16. Recommended Lead Reflow Soldering Profile

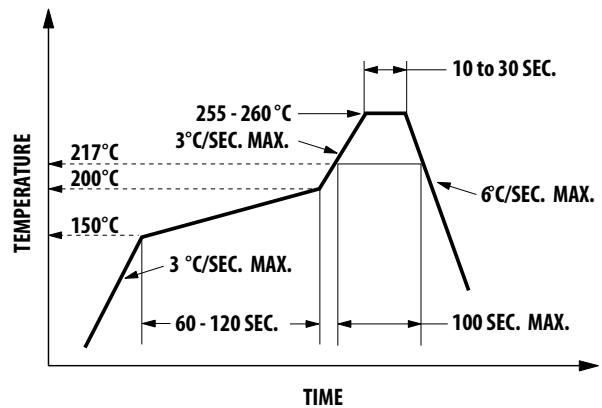

Figure 17. Recommended Pb-Free Reflow Soldering Profile

Note: For detailed information on reflow soldering of Avago Surface Mount LED, refer to Avago Application Note AN1060 Surface Mounting SMT LED Indicator Components.

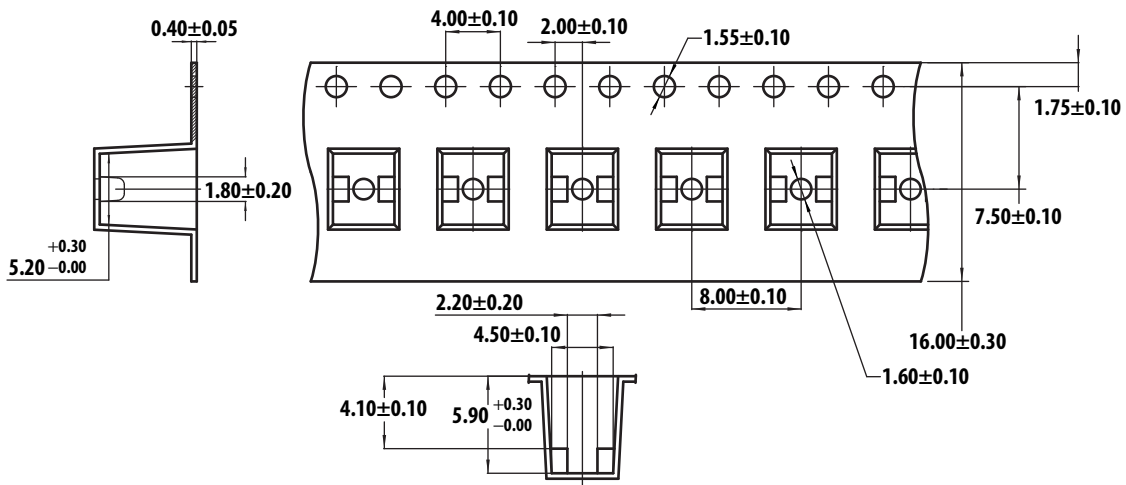

Figure 18. Carrier Tape Dimension

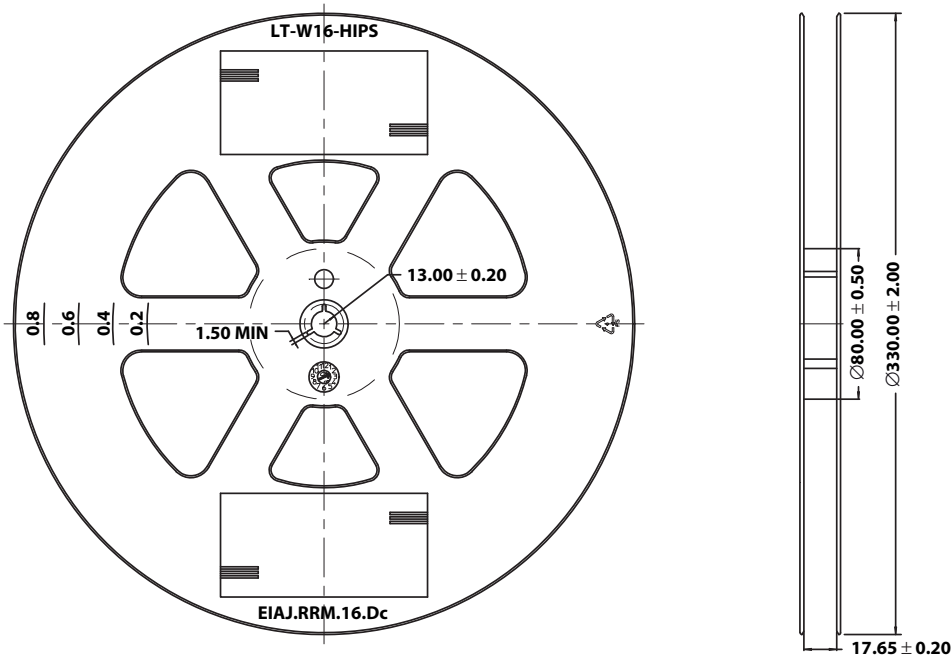

Figure 19. Reel Dimension

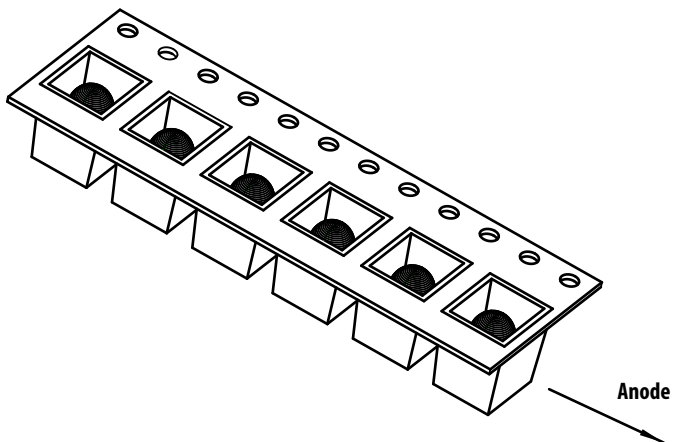

Figure 20. Unit Orientation from reel

Intensity Bin Limit Table (1.2:1 Iv bin ratio)

Bin	Intensity (mcd) at 20 mA	
	Min	Max
S	660	800
T	800	960
U	960	1150
V	1150	1380
W	1380	1660
X	1660	1990
Y	1990	2400
Z	2400	2900
1	2900	3500
2	3500	4200
3	4200	5040
4	5040	6050

Tolerance for each bin limit is $\pm 15\%$

VF Bin Table (V at 20 mA) for Red & Amber

Bin ID	Min	Max
VD	1.8	2.0
VA	2.0	2.2
VB	2.2	2.4

Tolerance for each bin limit is $\pm 0.05V$

Red Color Range

Min Dom	Max Dom	X min	Y Min	X max	Y max
618.0	630.0	0.6872	0.3126	0.6890	0.2943
		0.6690	0.3149	0.7080	0.2920

Tolerance for each bin limit is $\pm 0.5nm$

Amber Color Range

Bin	Min Dom	Max Dom	Xmin	Ymin	Xmax	Ymax
1	584.5	587.0	0.5420	0.4580	0.5530	0.4400
			0.5370	0.4550	0.5570	0.4420
2	587.0	589.5	0.5570	0.4420	0.5670	0.4250
			0.5530	0.4400	0.5720	0.4270
4	589.5	592.0	0.5720	0.4270	0.5820	0.4110
			0.5670	0.4250	0.5870	0.4130
6	592.0	594.5	0.5870	0.4130	0.5950	0.3980
			0.5820	0.4110	0.6000	0.3990

Tolerance for each bin limit is $\pm 0.5nm$

Green Color Range

Bin	Min Dom	Max Dom	Xmin	Ymin	Xmax	Ymax
1	519.0	523.0	0.0667	0.8323	0.1450	0.7319
			0.1200	0.7375	0.0979	0.8316
2	523.0	527.0	0.0979	0.8316	0.1711	0.7218
			0.1450	0.7319	0.1305	0.8189
3	527.0	531.0	0.1305	0.8189	0.1967	0.7077
			0.1711	0.7218	0.1625	0.8012
4	531.0	535.0	0.1625	0.8012	0.2210	0.6920
			0.1967	0.7077	0.1929	0.7816
5	535.0	539.0	0.1929	0.7816	0.2445	0.6747
			0.2210	0.6920	0.2233	0.7600

Tolerance for each bin limit is ± 0.5 nm

Blue Color Range

Bin	Min Dom	Max Dom	Xmin	Ymin	Xmax	Ymax
1	460.0	464.0	0.1440	0.0297	0.1766	0.0966
			0.1818	0.0904	0.1374	0.0374
2	464.0	468.0	0.1374	0.0374	0.1699	0.1062
			0.1766	0.0966	0.1291	0.0495
3	468.0	472.0	0.1291	0.0495	0.1616	0.1209
			0.1699	0.1062	0.1187	0.0671
4	472.0	476.0	0.1187	0.0671	0.1517	0.1423
			0.1616	0.1209	0.1063	0.0945
5	476.0	480.0	0.1063	0.0945	0.1397	0.1728
			0.1517	0.1423	0.0913	0.1327

Tolerance for each bin limit is ± 0.5 nm

Moisture Sensitivity and Handling

The ALMD-Lx36 series oval package has a Moisture Sensitive Level 2a rating per JEDEC J-STD-020. Refer to Avago Application Note AN5305, Handling of Moisture Sensitive Surface Mount Devices, for additional details and a review of proper handling procedures.

A. Storage before use

- An unopened moisture barrier bag (MBB) can be stored at < 40 °C/90% RH for 12 months. If the actual shelf life has exceeded 12 months and the humidity indicator card (HIC) indicates that baking is not required then it is safe to reflow solder the LEDs per the original MSL rating.
- It is recommended that the MBB not be opened prior to assembly (e.g., for IQC).

B. Control after opening the MBB

- The humidity indicator card (HIC) shall be read immediately upon opening of the MBB.
- The LEDs must be kept at < 30 °C/60% RH at all times, and all high temperature related processes including soldering, curing or rework need to be completed within 672 hours.

C. Control for unfinished tape and reel parts

- Unused LEDs must be stored in a sealed MBB with a desiccant or desiccator at < 5% RH.

D. Control of assembled boards

- If the PCB soldered with the LEDs is to be subjected to other high temperature processes, the PCB needs to be stored in a sealed MBB with desiccant or desiccator at < 5% RH to ensure that all LEDs have not exceeded their floor life of 672 hours

E. Baking is required if:

- The HIC indicator is not BROWN at 10% and is AZURE at 5%
- The LEDs are exposed to a condition of > 30 °C/60% RH at any time.
- The LED floor life exceeded 672 hours.

The recommended baking condition is: 60 ± 5 °C for 20 hours.

DISCLAIMER: Avago's products and software are not specifically designed, manufactured or authorized for sale as parts, components or assemblies for the planning, construction, maintenance or direct operation of a nuclear facility or for use in medical devices or applications. Customer is solely responsible, and waives all rights to make claims against avago or its suppliers, for all loss, damage, expense or liability in connection with such use.

For product information and a complete list of distributors, please go to our web site: www.avagotech.com

Avago, Avago Technologies, and the A logo are trademarks of Avago Technologies in the United States and other countries. Data subject to change. Copyright © 2005-2013 Avago Technologies. All rights reserved. AV02-2377EN - February 26, 2013

AVAGO
TECHNOLOGIES

Компания «Life Electronics» занимается поставками электронных компонентов импортного и отечественного производства от производителей и со складов крупных дистрибьюторов Европы, Америки и Азии.

С конца 2013 года компания активно расширяет линейку поставок компонентов по направлению коаксиальный кабель, кварцевые генераторы и конденсаторы (керамические, пленочные, электролитические), за счёт заключения дистрибьюторских договоров

Мы предлагаем:

- Конкурентоспособные цены и скидки постоянным клиентам.
- Специальные условия для постоянных клиентов.
- Подбор аналогов.
- Поставку компонентов в любых объемах, удовлетворяющих вашим потребностям.
- Приемлемые сроки поставки, возможна ускоренная поставка.
- Доставку товара в любую точку России и стран СНГ.
- Комплексную поставку.
- Работу по проектам и поставку образцов.
- Формирование склада под заказчика.
- Сертификаты соответствия на поставляемую продукцию (по желанию клиента).
- Тестирование поставляемой продукции.
- Поставку компонентов, требующих военную и космическую приемку.
- Входной контроль качества.
- Наличие сертификата ISO.

В составе нашей компании организован Конструкторский отдел, призванный помогать разработчикам, и инженерам.

Конструкторский отдел помогает осуществить:

- Регистрацию проекта у производителя компонентов.
- Техническую поддержку проекта.
- Защиту от снятия компонента с производства.
- Оценку стоимости проекта по компонентам.
- Изготовление тестовой платы монтаж и пусконаладочные работы.



Тел: +7 (812) 336 43 04 (многоканальный)
Email: org@lifeelectronics.ru