

### Miniature Timer Compatible with the MY Relay

- Large transparent time-setting knob facilitates time setting. Flat-blade and Phillips screwdrivers can also be used for time setting.
- Approved by UL and CSA.
- Pin configuration compatible with MY Power Relay.
- LED indication for power and output statuses.
- Conforms to EMC standards.
- High repeat accuracy.

RC

### Ordering Information

Operation/resetting system	Time-limit contact	Time ranges	Supply voltage	Model
				Surface /DIN-track mounting (with socket)
Time-limit operation/ self-resetting	DPDT	0.1 s to 60 s	110 VAC	H3Y-2
			220 VAC	
			24 VDC	
	4PDT		110 VAC	H3Y-4
			220 VAC	
			24 VDC	

**Note:** 1. Specify the model number, supply voltage, and rated time when ordering.

Ex. H3Y-2 110 VAC 1 s  
└───┬─── Rated time  
└───┬─── Supply voltage

2. Track mounted socket can be used as a front connecting socket.

### Accessories

Track mounted socket (see note 2)	Back connecting socket		
	Solder terminal	Wire-wrap terminal	PC terminal
PYF08A	PY08	PY08QN(2)	PY08-02
PYF14A	PY14	PY14QN(2)	PY14-02

### Specifications

#### Time Ranges

Rated time	1 s	5 s	10 s	30 s	60 s
Time setting range	0.1 to 1 s	0.2 to 5 s	0.5 to 10 s	1.0 to 30 s	2.0 to 60 s

## ■ Ratings

Item	H3Y-2/H3Y-4
Rated supply voltage	110, 220 VAC (50/60 Hz), 24 VDC (see note)
Operating voltage range	85% to 110% of rated supply voltage
Power consumption	100 VAC: Relay ON: 1.5 VA (1.3 W) Relay OFF: 0.8 VA (0.5 W) 200 VAC: Relay ON: 1.8 VA (1.5 W) Relay OFF: 1.2 VA (0.9 W) 24 VDC: Relay ON: 0.9 W Relay OFF: 0.07 W
Control outputs	H3Y-2: 5 A at 250 VAC, resistive load ( $\cos\phi = 1$ ) H3Y-4: 3 A at 250 VAC, resistive load ( $\cos\phi = 1$ )

**Note:** With DC ratings, single-phase full-wave rectified power sources may be used.

## ■ Characteristics

Accuracy of operating time	±2% max.
Setting error	±10% (max. time division at rated voltage and room temperature)
Reset time	0.1 s max.
Influence of voltage	±2% max.
Influence of temperature	±5% max.
Insulation resistance	100 MΩ min. (at 500 VDC)
Dielectric strength	2,000 VAC, 50/60 Hz for 1 min (between current-carrying terminals and exposed non-current-carrying metal parts) (see note) 2,000 VAC, 50/60 Hz for 1 min (between operating power circuit and control output) (see note) 2,000 VAC, 50/60 Hz for 1 min (between different pole contacts; 2-pole model) (see note) 1,500 VAC, 50/60 Hz for 1 min (between different pole contacts; 4-pole model) 1,000 VAC, 50/60 Hz for 1 min (between non-continuous contacts)
Vibration resistance	Destruction: 10 to 55 Hz with 1.0-mm double amplitude Malfunction: 10 to 55 Hz with 1.0-mm double amplitude
Shock resistance	Destruction: 1,000 m/s <sup>2</sup> (approx. 100G) Malfunction: 100 m/s <sup>2</sup> (approx. 10G)
Ambient temperature	Operating: -10°C to 50°C (with no icing)
Ambient humidity	Operating: 35% to 85%
Life expectancy	Mechanical: 10,000,000 operations min. (under no load at 1,800 operations/h) Electrical: H3Y-2: 500,000 operations min. (5 A at 250 VAC, resistive load at 1800 operations/h) H3Y-4: 200,000 operations min. (3 A at 250 VAC, resistive load at 1800 operations/h)
EMC	Emission Enclosure: EN55011 Group 1 class A Emission AC Mains: EN55011 Group 1 class A Immunity ESD: IEC801-2: 4 kV contact discharge (level 2) 4 kV air discharge (level 2) Immunity RF-interference: ENV50140: 10 V/m (80 MHz to 1 GHz) (level 3) Immunity Conducted Disturbance: ENV50141: 10 V (0.15 to 80 MHz) (level 3) Immunity Burst: IEC801-4: 2 kV power-line (level 3) 2 kV I/O signal-line (level 4)
Approved standards	UL (File No. E41515), CSA (File No. LR22310) Conforms to EN50081-2, EN50082-2
Weight	Approx. 50 g

**Note:** Terminal screw sections are excluded.

# Engineering Data

H3Y-2

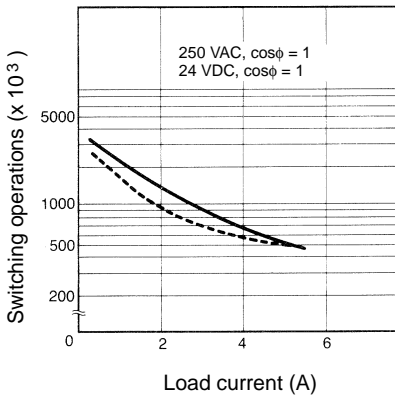

H3Y-2

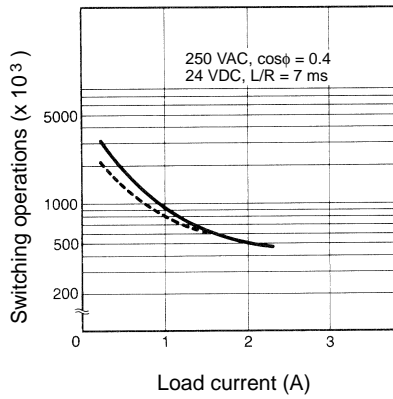

Reference: A maximum current of 0.6 A can be switched at 125 VDC ( $\cos\phi = 1$ ). Maximum current of 0.2 A can be switched if L/R is 7 ms. In both cases, a life of 100,000 operations can be expected. The minimum applicable load is 1 mA at 5 VDC (P reference value).

H3Y-4

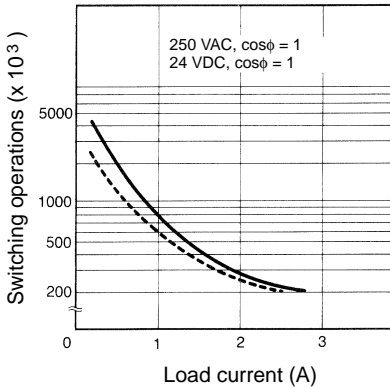

H3Y-4

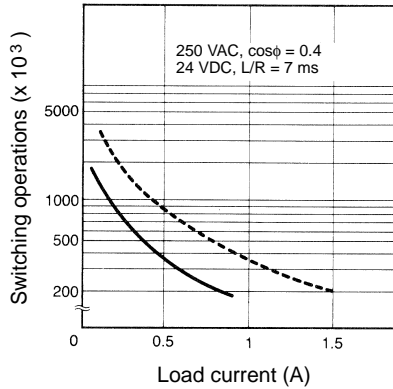

Reference: A maximum current of 0.5 A can be switched at 125 VDC ( $\cos\phi = 1$ ). Maximum current of 0.2 A can be switched if L/R is 7 ms. In both cases, a life of 100,000 operations can be expected. The minimum applicable load is 1 mA at 1 VDC (P reference value).

# Operation

## ■ Timing Chart

H3Y-2

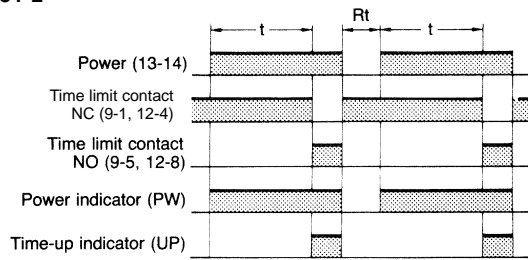

H3Y-4

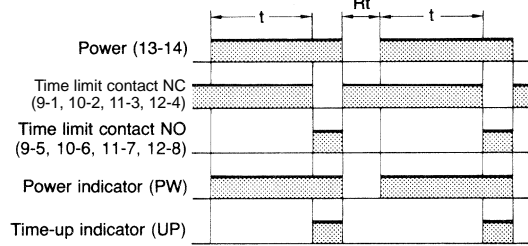

# Dimensions

Note: All units are in millimeters unless otherwise indicated.

## ■ Timers

H3Y-2

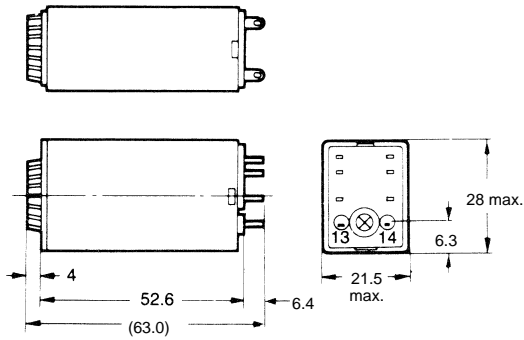

H3Y-4

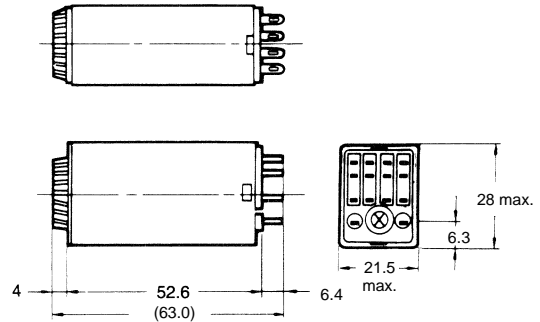

## ■ Accessories (Order Separately)

Use the PYF□A, PY□, PY□-02, or PY□QN(2) to mount the H3Y. When ordering any one of these sockets, replace "□" with "08" or "14."

### Track Mounting/Front Connecting Sockets

PYF08A

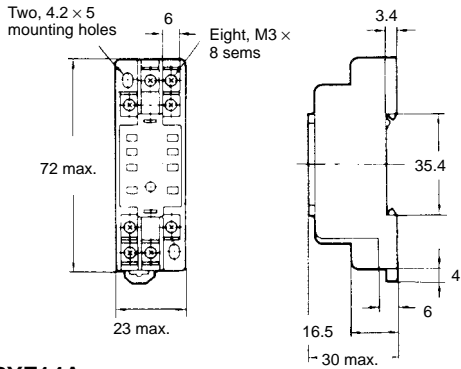

Terminal Arrangement (Top View)

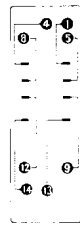

Mounting Holes

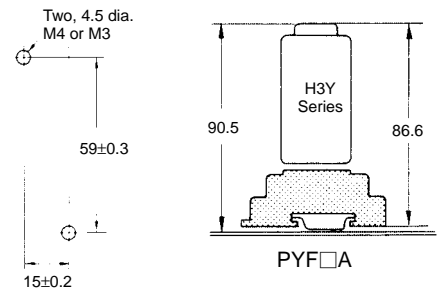

PYF14A

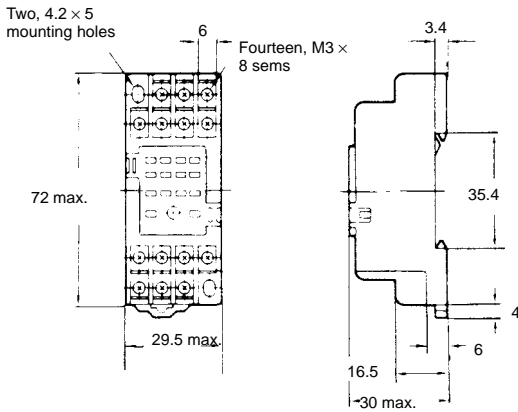

Terminal Arrangement (Top View)

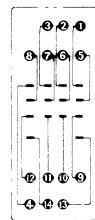

Mounting Holes

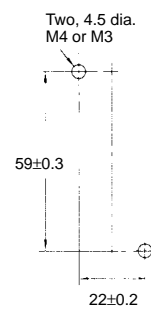

**PYF08A-N**

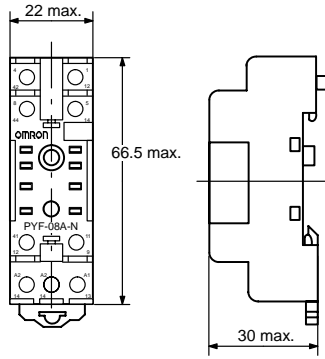

**Terminal Arrangement**

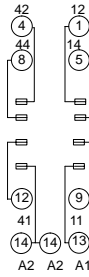

**Mounting Holes (for Surface Mounting)**

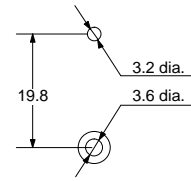

**PYF14A-N**

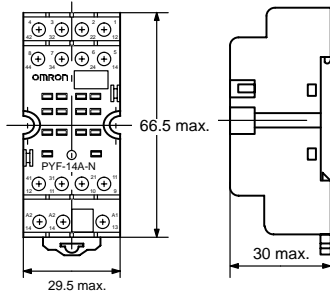

**Terminal Arrangement**

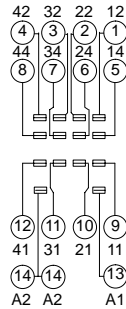

**Mounting Holes (for Surface Mounting)**

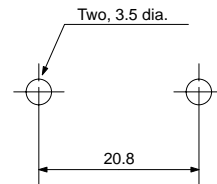

**Back Connecting Sockets**

**PY08, PY14**

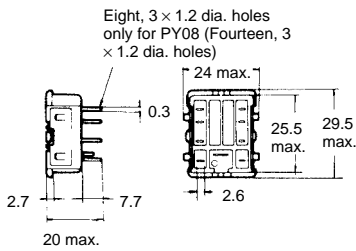

**Terminal Arrangement (Bottom View)**

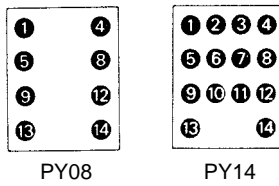

**Panel Cutout**

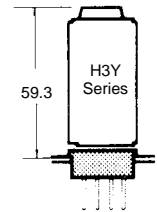
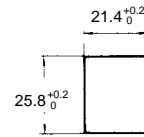

PY□, PY□-02, PY□QN(2)

**PY08QN, PY14QN  
PY08QN(2), PY14QN(2)**

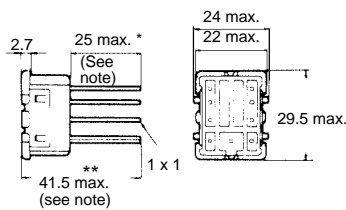

**Terminal Arrangement (Bottom View)**

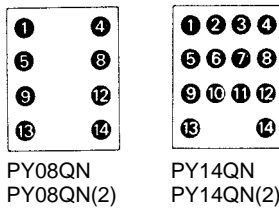

**Note:** With PY□QN(2), dimension \* should read 20 max. and dimension \*\* 36.5 max.

**PY08-02, PY14-02**

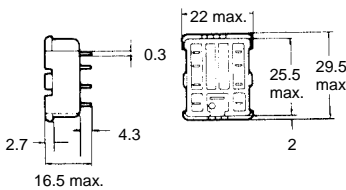

**Terminal Arrangement (Bottom View)**

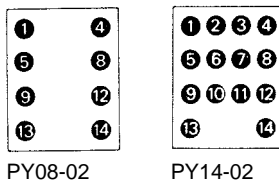

**Socket Mounting Plates (t = 1.6)**

Applicable socket	For mounting 1 socket	For mounting 18 sockets
PY08, PY14, PY08QN(2), PY14QN(2)	PYP-1	PYP-18

**Note:** PYP-18 may be cut to any desired length.

**PYP-1**

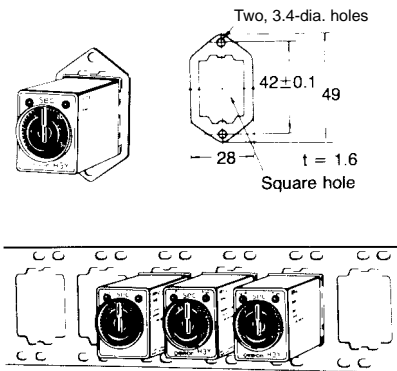

**PYP-18**

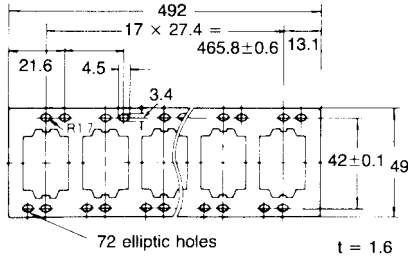

**Relay Hold-down Clips**

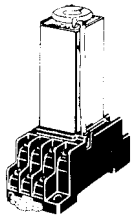

**Y92H-3 for PYF□A Socket**

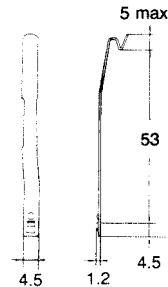

**Y92H-4 for PY□ Socket**

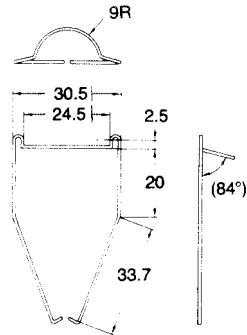

**Mounting Track**

**PFP-100N/PFP-50N** (see note 1)

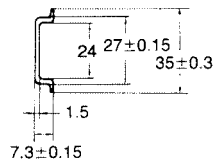
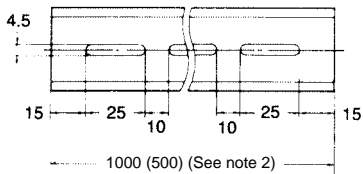

**Note:** 1. Meets DIN EN50022  
2. This dimension applies to PFP-50N.

**End Plate**

**PFP-M**

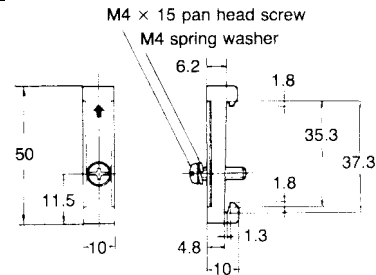

**Spacer**

**PFP-S**

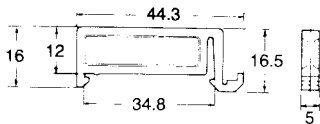

# Installation

## ■ Connection

H3Y-2

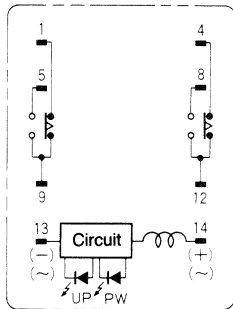

Connect the DC power supply to terminals 13 and 14 according to the polarity marks.

H3Y-4

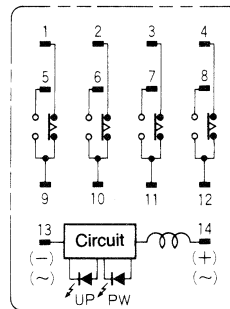

Connect the DC power supply to terminals 13 and 14 according to the polarity marks.

## Precautions

When selecting a control output, use the H3Y-2 for switching ON and OFF the power and the H3Y-4 for switching ON and OFF the minute load.

The operating voltage will increase when using the H3Y in any place where the ambient temperature is more than 50°C. Supply 90% to 110% of the rated voltages (at 12 VDC: 95% to 110%) when operating at 50°C or higher.

Do not leave the H3Y in time-up condition for a long period of time (for example, more than one month in any place where the ambient temperature is high), otherwise the internal parts (aluminum electrolytic capacitor) may become damaged. Therefore, the use of the H3Y with a relay as shown in the following circuit diagram is recommended to extend the service life of the H3Y.

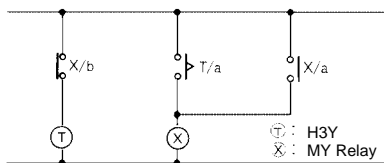

Use the following safety circuit when building a self-holding or self-resetting circuit with the H3Y and an auxiliary relay, such as an MY Relay, in combination.

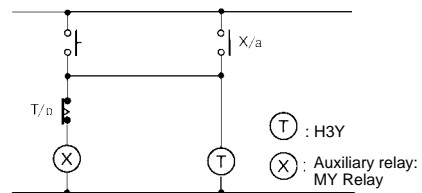

Do not use the H3Y in places where there is excessive dust, corrosive gas, or direct sunlight.

Do not mount more than one H3Y closely together, otherwise the internal parts may become damaged. Make sure that there is a space of 5 mm or more between any H3Y Models next to each other to allow heat radiation.

The internal parts may become damaged if a supply voltage other than the rated ones is imposed on the H3Y. When more than 100 V is applied to 12 or 24 VDC, the internal element (varistor) may break.

Do not connect the H3Y as shown in the following circuit diagram on the right hand side, otherwise the H3Y's internal contacts different from each other in polarity may become short-circuited.

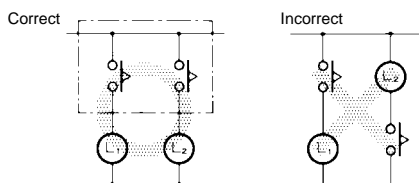

Limited issue for Southeast Asian countries

**ALL DIMENSIONS SHOWN ARE IN MILLIMETERS.**

To convert millimeters into inches, multiply by 0.03937. To convert grams into ounces, multiply by 0.03527.

Cat. No. L91-E1-1      **In the interest of product improvement, specifications are subject to change without notice.**

## **OMRON Corporation**

Systems Components Division H.Q.  
28th Fl., Crystal Tower Bldg.  
1-2-27, Shiromi, Chuo-ku,  
Osaka 540 Japan  
Phone: 06-949-6012 Fax: 06-949-6021

Printed in Japan  
0197-1M (0197) a



Компания «Life Electronics» занимается поставками электронных компонентов импортного и отечественного производства от производителей и со складов крупных дистрибьюторов Европы, Америки и Азии.

С конца 2013 года компания активно расширяет линейку поставок компонентов по направлению коаксиальный кабель, кварцевые генераторы и конденсаторы (керамические, пленочные, электролитические), за счёт заключения дистрибьюторских договоров

Мы предлагаем:

- Конкурентоспособные цены и скидки постоянным клиентам.
- Специальные условия для постоянных клиентов.
- Подбор аналогов.
- Поставку компонентов в любых объемах, удовлетворяющих вашим потребностям.
- Приемлемые сроки поставки, возможна ускоренная поставка.
- Доставку товара в любую точку России и стран СНГ.
- Комплексную поставку.
- Работу по проектам и поставку образцов.
- Формирование склада под заказчика.
- Сертификаты соответствия на поставляемую продукцию (по желанию клиента).
- Тестирование поставляемой продукции.
- Поставку компонентов, требующих военную и космическую приемку.
- Входной контроль качества.
- Наличие сертификата ISO.

В составе нашей компании организован Конструкторский отдел, призванный помогать разработчикам, и инженерам.

Конструкторский отдел помогает осуществить:

- Регистрацию проекта у производителя компонентов.
- Техническую поддержку проекта.
- Защиту от снятия компонента с производства.
- Оценку стоимости проекта по компонентам.
- Изготовление тестовой платы монтаж и пусконаладочные работы.



Тел: +7 (812) 336 43 04 (многоканальный)

Email: [org@lifeelectronics.ru](mailto:org@lifeelectronics.ru)