

TimerBlox: Oscillators, One Shots, PWM, Delay, Power on Reset

DESCRIPTION

Demonstration circuit 1562B is an engineering tool to design and evaluate the LTC699X-X family of TimerBlox® circuits. The center section of the board contains a pre-configured TimerBlox function. DC1562B comes in twelve timing function variations as outlined in Table 1.

Surrounding the center board is a playground prototyping area. The prototyping area has pads for DIP-8, S8, MS8, or S6 packages with bread boarding connections to each pin and two convenient power buses and ground bus surrounding the entire area. This area is for conditioning signals to control the timer function and for adding loads controlled in time.

The center part of the board can be detached as a streamlined circuit, to combine with a pre-existing circuit. For application flexibility, a provision is made for buffering and inverting the output of the timer. An optional NC7W04P6X SC70 package dual inverter can be added at U2 to provide this functionality.

Design files for this circuit board are available at <http://www.linear.com/demo>

LT, LT, LTC, LTM, Linear Technology, TimerBlox and the Linear logo are registered trademarks of Linear Technology Corporation. All other trademarks are the property of their respective owners.

USING THE DEMO BOARD

To understand the simplicity and flexibility of the TimerBlox function, download the appropriate data sheet from the LTC website, www.linear.com. Each evaluation board comes with a TimerBlox part, decoupling cap and a bulk decoupling 10 μ F tantalum cap. Resistors are also installed that configure the TimerBlox device so that they are ready to use by simply adding power. Changing the default configuration of the demo board is a simple matter of determining a few new resistor values. Simply select a pair of resistor values for the DIV value from the data sheet DIV table, calculate the value of R_{SET} required, replace the resistor on the board, apply power, and go! Single supply power between 2.25V and 5.5V and ground must be supplied directly to the center board.

The outer prototyping section of the board can be used with single or dual supplies as required. **When using the prototyping area, the outermost trace, which is ground, must be connected (hand wired) to the ground on the center board section.** All input and output holes are sized for 65mil turret terminals, or wires can be soldered in the holes directly.

Changing the timer configuration requires changing resistor values on the center board. The resistor lead holes can accept “pressed-in” DIP sockets, or resistors can be soldered directly in the holes. Pads for 0805 surface mount resistors are also included at each position where a leaded resistor could be used. Pads are also included for three 25-turn trim pots which can be used to replace R_{SET} (R8) for master oscillator frequency adjustment, PSF in (R10) for voltage controlled options, and R_{DEV} (R7) for frequency divider control to permit real-time adjustments while running.

DEMO MANUAL DC1562B

USING THE DEMO BOARD

Table 1. Standard Configuration for Each Version

DEMO BOARD NUMBER	LTC PART NUMBER	PART MARKING	FUNCTION	CONFIGURED FUNCTION
DC1562B-A	LTC6990	LTDWW	HF OSC	1kHz to 10kHz Voltage Controlled Oscillator
DC1562B-B	LTC6991	LTDWY	LF OSC	1Hz (1Sec) Fixed Frequency Oscillator
DC1562B-C	LTC6992-1	LTDXB	PWM	10kHz 0% to 100% Duty Cycle PWM
DC1562B-D	LTC6992-2	LTDXD	PWM	10kHz 5% to 95% Duty Cycle PWM
DC1562B-E	LTC6992-3	LTFCQ	PWM	10kHz 0% to 95% Duty Cycle PWM
DC1562B-F	LTC6992-4	LTFCV	PWM	10kHz 5% to 100% Duty Cycle PWM
DC1562B-G	LTC6993-1	LTDXG	One-Shot	RET* 100ms Positive Output Pulse
DC1562B-H	LTC6993-2	LTDXJ	One-Shot	RET* Retriggerable 100ms Positive Output Pulse
DC1562B-I	LTC6993-3	LTFMH	One-Shot	FET** Positive 100ms Output Pulse
DC1562B-J	LTC6993-4	LTFMK	One-Shot	FET** Retriggerable 100ms Positive Output Pulse
DC1562B-K	LTC6994-1	LTFCV	Delay	Output Falling Edge Delayed 100ms from Input Falling Edge
DC1562B-L	LTC6994-2	LTFCX	Delay	Output Rise/Fall Edges Delayed 100ms from Input Rise/Fall Edges
DC1562B-M	LTC6995-1	LTGJN	POR	1sec Power on Reset
DC1562B-N	LTC6995-2	LTGJQ	POR	1sec Power on Reset

* Rising Edge Triggered

** Falling Edge Triggered

USING THE DEMO BOARD

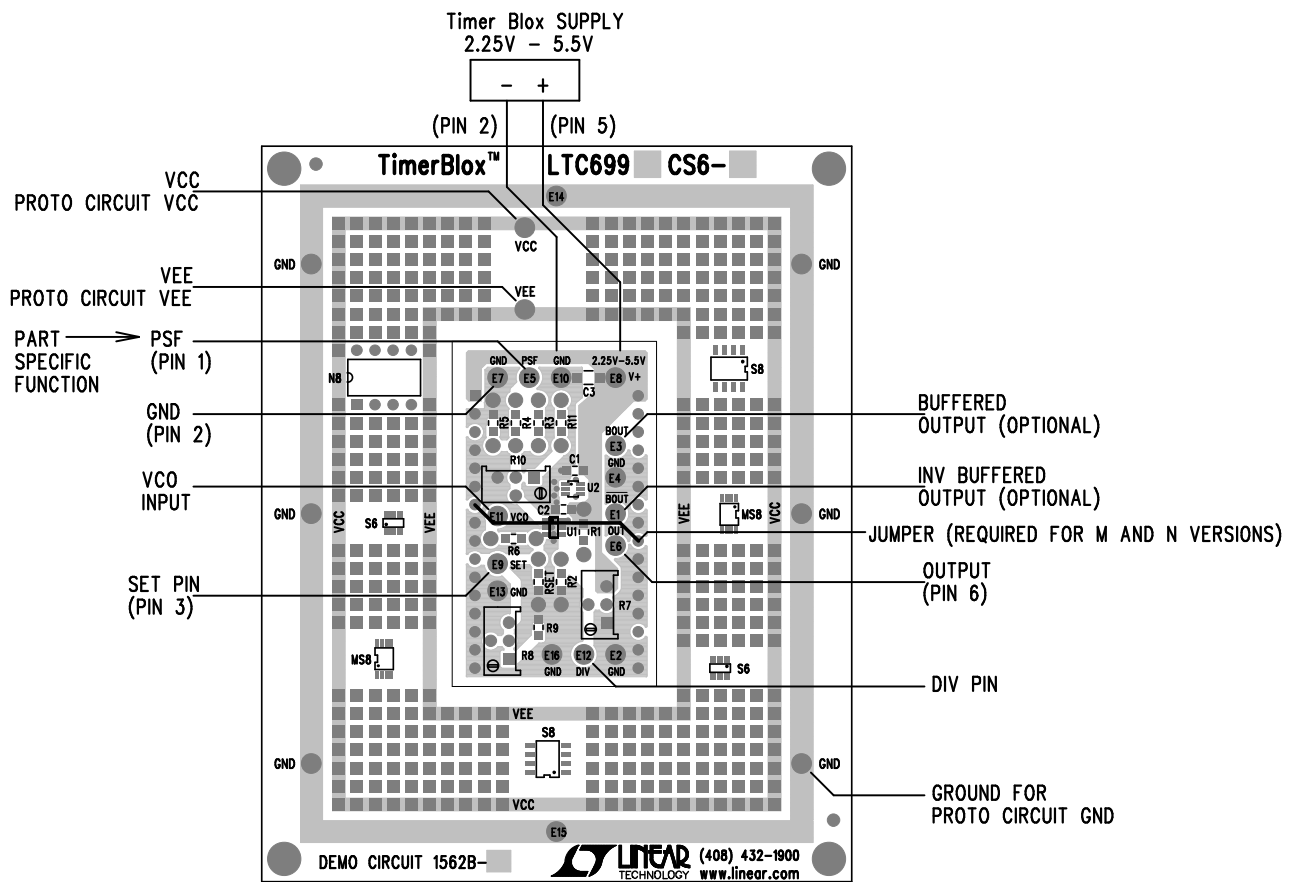

Figure 1. DC1562B-X External Connection Diagram

USING THE DEMO BOARD

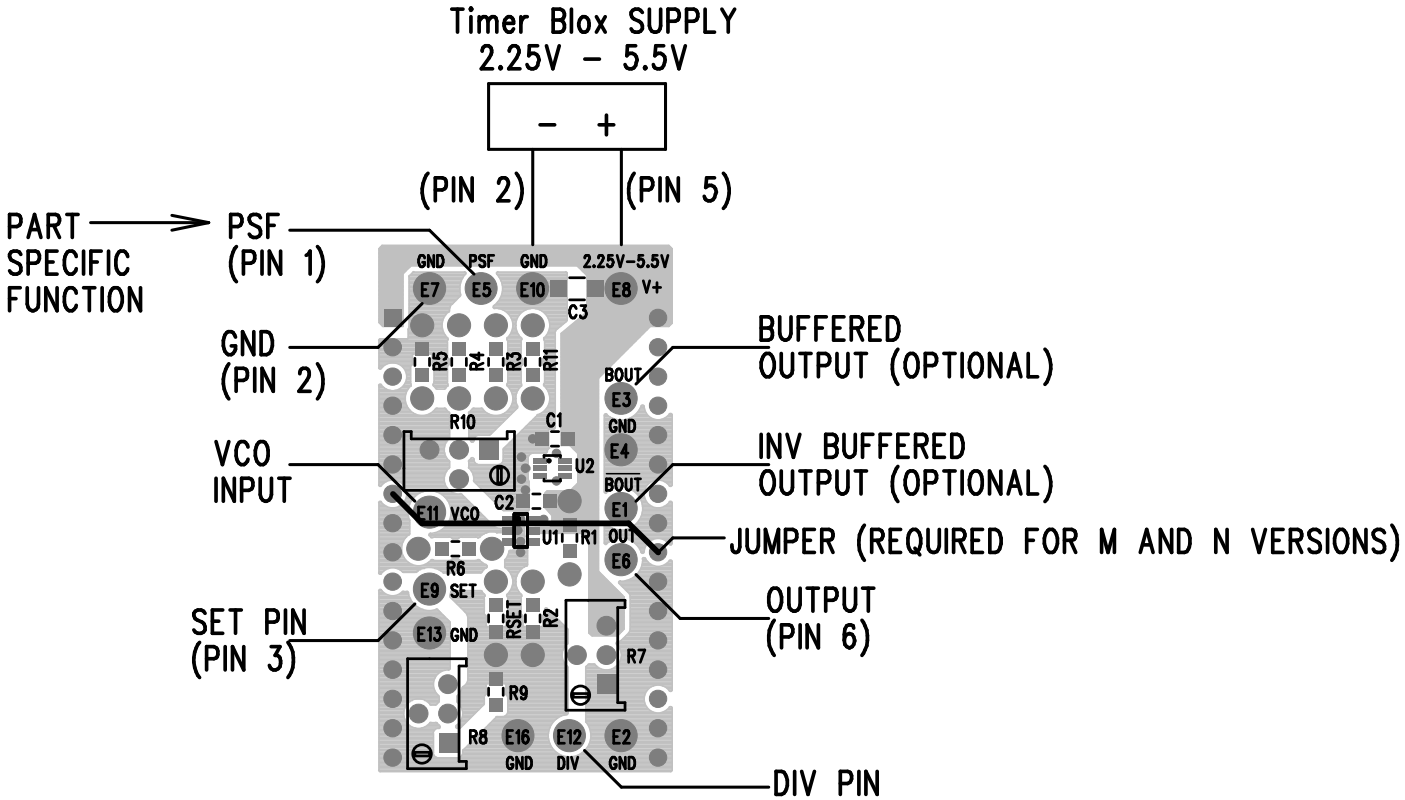

Figure 2. DC1562B-X Center Board Connection Diagram

DEFAULT CIRCUIT CONFIGURATIONS FOR EACH VERSION



Figure 3. DC1562B-A, 1kHz to 10kHz VCO



Figure 4. DC1562B-B, 1Hz (1Sec Period) Fixed Frequency Oscillator



Figure 5. DC1562B-C, 10kHz 0% to 100% Duty Cycle PWM

DEFAULT CIRCUIT CONFIGURATIONS FOR EACH VERSION



Figure 6. DC1562B-D, 10kHz 5% to 95% Duty Cycle PWM



Figure 7. DC1562B-E, 10kHz 0% to 95% Duty Cycle PWM



Figure 8. DC1562B-F, 10kHz 5% to 100% Duty Cycle PWM

DEFAULT CIRCUIT CONFIGURATIONS FOR EACH VERSION

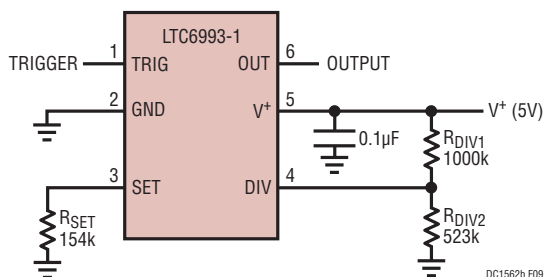

Figure 9. DC1562B-G, Rising Edge Triggered 100ms Positive Output Pulse One-Shot



Figure 10. DC1562B-H, Rising Edge Retriggered 100ms Positive Output Pulse One-Shot



Figure 11. DC1562B-I, Falling Edge Triggered 100ms Positive Output Pulse One-Shot

DEFAULT CIRCUIT CONFIGURATIONS FOR EACH VERSION



Figure 12. DC1562B-J, Falling Edge Retriggerable 100ms Positive Output Pulse One-Shot

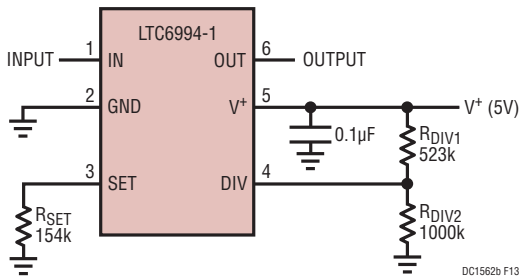

Figure 13. DC1562B-K, 100ms Delayed Output Falling Edge from Input Falling Edge

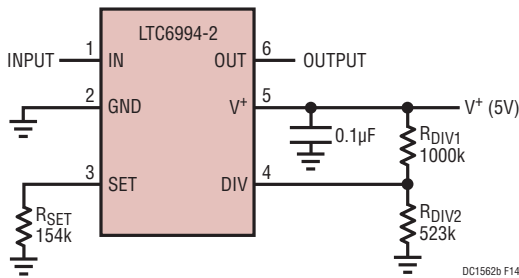

Figure 14. DC1562B-L, 100ms Delayed Output Edge from Input Edge, Both Rising and Falling Edges

DEFAULT CIRCUIT CONFIGURATIONS FOR EACH VERSION



Figure 15. DC1562B-M, 1sec Active Low Power on Reset

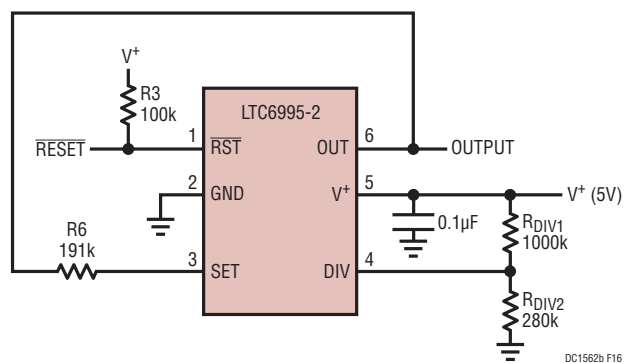

Figure 16. DC1562B-N, 1sec Active Low Power on Reset

DEMO MANUAL DC1562B

PARTS LIST

ITEM	QTY	REFERENCE	PART DESCRIPTION	MANUFACTURER/PART NUMBER
1	0	C1 (OPT.)	CAP., 0805	
2	1	C2	CAP., CHIP, X7R, 0.1µF, 25V, 0805	TDK, C2012X7R1H104K
3	1	C3	Cap., CHIP, X5R, 10µF, 16V, 1206	TAIYO YUDEN, EMK316BJ106KDT
4	24	E1-E16, E016-E18, E20-E24	TESTPOINT, TURRET, .064"	MILL-MAX, 2308-2-00-80-00-00-07-0
5	0	R9-R11 (OPT.)	RES., 0805	
6	0	R7, R8, R10 (OPT.)	POT., 3266W or 3266Y	
7	0	U2 (OPT.)	IC., NC7WZ04P6X, SC-70	
8	0	OPTIONAL SOCKETS FOR LEADED COMPONENTS		MILL MAX, 8427-0-15-01-30-02-04-0

DC1562B-A

1	1	DC1562B	GENERAL BOM	
2	1	R1	RES., CHIP, 1M, 1% 0805	VISHAY, CRCW08051M00FKEA
3	1	R2	RES., CHIP, 681k, 1% 0805	VISHAY, CRCW0805681KFKEA
4	1	R3	RES., CHIP, 100k, 1% 0805	VISHAY, CRCW0805100KFKEA
5	1	R4	RES., CHIP, 0Ω, 1% 0805	VISHAY, CRCW08050000Z0EA
6	0	R5 (OPEN)	RES., 0805	
7	1	R6	RES., CHIP, 432k, 1% 0805	VISHAY, CRCW0805432KFKEA
8	1	RSET	RES., CHIP, 95.3k, 1% 0805	VISHAY, CRCW080595K3FKEA
9	1	U1	IC., TimerBlox FAMILY, SOT-23	LINEAR TECH., LTC6990CS6

DC1562B-B

1	1	DC1562B	GENERAL BOM	
2	1	R1	RES., CHIP, 976k, 1% 0805	VISHAY, CRCW0805976KFKEA
3	1	R2	RES., CHIP, 182k, 1% 0805	VISHAY, CRCW0805182KFKEA
4	0	R3 (OPEN)	RES., 0805	
5	1	R4	RES., CHIP, 0Ω, 1% 0805	VISHAY, CRCW08050000Z0EA
6	1	R5	RES., CHIP, 100k, 1% 0805	VISHAY, CRCW0805100KFKEA
7	0	R6 (OPEN)	RES., 0805	
8	1	RSET	RES., CHIP, 768k, 1% 0805	VISHAY, CRCW0805768KFKEA
9	1	U1	IC., TimerBlox FAMILY, SOT-23	LINEAR TECH., LTC6991CS6

DC1562B-C

1	1	DC1562B	GENERAL BOM	
2	1	R1	RES., CHIP, 976k, 1% 0805	VISHAY, CRCW0805976KFKEA
3	1	R2	RES., CHIP, 182k, 1% 0805	VISHAY, CRCW0805182KFKEA
4	1	R3	RES., CHIP, 80.6k, 1% 0805	VISHAY, CRCW080580K6FKEA
5	1	R4	RES., CHIP, 10k, 1% 0805	VISHAY, CRCW080510K0FKEA
6	1	R5	RES., CHIP, 1.96k, 1% 0805	VISHAY, CRCW08051K96FKEA
7	0	R6 (OPEN)	RES., 0805	
8	1	RSET	RES., CHIP, 316k, 1% 0805	VISHAY, CRCW0805316KFKEA
9	1	U1	IC., TimerBlox FAMILY SOT-23	LINEAR TECH., LTC6992CS6-1

DC1562B-D

1	1	DC1562B	GENERAL BOM	
2	1	R1	RES., CHIP, 976k, 1% 0805	VISHAY, CRCW0805976KFKEA
3	1	R2	RES., CHIP, 182k, 1% 0805	VISHAY, CRCW0805182KFKEA
4	1	R3	RES., CHIP, 51.1k, 1% 0805	VISHAY, CRCW080551K1FKEA
5	1	R4	RES., CHIP, 10k, 1% 0805	VISHAY, CRCW080510K0FKEA
6	1	R5	RES., CHIP, 1.74k, 1% 0805	VISHAY, CRCW08051K74FKEA
7	0	R6 (OPEN)	RES., 0805	
8	1	RSET	RES., CHIP, 316k, 1% 0805	VISHAY, CRCW0805316KFKEA
9	1	U1	IC., TimerBlox FAMILY SOT-23	LINEAR TECH., LTC6992CS6-2

PARTS LIST

ITEM	QTY	REFERENCE	PART DESCRIPTION	MANUFACTURER/PART NUMBER
DC1562B-E				
1	1	DC1562B	GENERAL BOM	
2	1	R1	RES., CHIP, 976k, 1% 0805	VISHAY, CRCW0805976KFKEA
3	1	R2	RES., CHIP, 182k, 1% 0805	VISHAY, CRCW0805182KFKEA
4	1	R3	RES., CHIP, 76.8k, 1% 0805	VISHAY, CRCW080576K8FKEA
5	1	R4	RES., CHIP, 10k, 1% 0805	VISHAY, CRCW080510K0FKEA
6	1	R5	RES., CHIP, 1.82k, 1% 0805	VISHAY, CRCW08051K82FKEA
7	0	R6 (OPEN)	RES., 0805	
8	1	RSET	RES., CHIP, 316k, 1% 0805	VISHAY, CRCW0805316KFKEA
9	1	U1	IC., TimerBlox FAMILY SOT-23	LINEAR TECH., LTC6992CS6-3
DC1562B-F				
1	1	DC1562B	GENERAL BOM	
2	1	R1	RES., CHIP, 976k, 1% 0805	VISHAY, CRCW0805976KFKEA
3	1	R2	RES., CHIP, 182k, 1% 0805	VISHAY, CRCW0805182KFKEA
4	1	R3	RES., CHIP, 54.9k, 1% 0805	VISHAY, CRCW080554K9FKEA
5	1	R4	RES., CHIP, 10k, 1% 0805	VISHAY, CRCW080510K0FKEA
6	1	R5	RES., CHIP, 1.87k, 1% 0805	VISHAY, CRCW08051K87FKEA
7	0	R6 (OPEN)	RES., 0805	
8	1	RSET	RES., CHIP, 316k, 1% 0805	VISHAY, CRCW0805316KFKEA
9	1	U1	IC., TimerBlox FAMILY SOT-23	LINEAR TECH., LTC6992CS6-4
DC1562B-G				
1	1	DC1562B	GENERAL BOM	
2	1	R1	RES., CHIP, 1M, 1% 0805	VISHAY, CRCW08051M00FKEA
3	1	R2	RES., CHIP, 523k, 1% 0805	VISHAY, CRCW0805523KFKEA
4	0	R3 (OPEN)	RES., 0805	
5	1	R4	RES., CHIP, 0 Ω , 1% 0805	VISHAY, CRCW08050000Z0EA
6	1	R5	RES., CHIP, 100k, 1% 0805	VISHAY, CRCW0805100KFKEA
7	0	R6 (OPEN)	RES., 0805	
8	1	RSET	RES., CHIP, 154k, 1% 0805	VISHAY, CRCW0805154KFKEA
9	1	U1	IC., TimerBlox FAMILY, SOT-23	LINEAR TECH., LTC6993CS6-1
DC1562B-H				
1	1	DC1562B	GENERAL BOM	
2	1	R1	RES., CHIP, 1M, 1% 0805	VISHAY, CRCW08051M00FKEA
3	1	R2	RES., CHIP, 523k, 1% 0805	VISHAY, CRCW0805523KFKEA
4	0	R3 (OPEN)	RES., 0805	
5	1	R4	RES., CHIP, 0 Ω , 1% 0805	VISHAY, CRCW08050000Z0EA
6	1	R5	RES., CHIP, 100k, 1% 0805	VISHAY, CRCW0805100KFKEA
7	0	R6 (OPEN)	RES., 0805	
8	1	RSET	RES., CHIP, 154k, 1% 0805	VISHAY, CRCW0805154KFKEA
9	1	U1	IC., TimerBlox FAMILY SOT-23	LINEAR TECH., LTC6993CS6-2
DC1562B-I				
1	1	DC1562B	GENERAL BOM	
2	1	R1	RES., CHIP, 1M, 1% 0805	VISHAY, CRCW08051M00FKEA
3	1	R2	RES., CHIP, 523k, 1% 0805	VISHAY, CRCW0805523KFKEA
4	0	R3 (OPEN)	RES., 0805	
5	1	R4	RES., CHIP, 0 Ω , 1% 0805	VISHAY, CRCW08050000Z0EA
6	1	R5	RES., CHIP, 100k, 1% 0805	VISHAY, CRCW0805100KFKEA
7	0	R6 (OPEN)	RES., 0805	
8	1	RSET	RES., CHIP, 154k, 1% 0805	VISHAY, CRCW0805154KFKEA
9	1	U1	IC., TimerBlox FAMILY SOT-23	LINEAR TECH., LTC6993CS6-3

DEMO MANUAL DC1562B

PARTS LIST

ITEM	QTY	REFERENCE	PART DESCRIPTION	MANUFACTURER/PART NUMBER
DC1562B-J				
1	1	DC1562B	GENERAL BOM	
2	1	R1	RES., CHIP, 1M, 1% 0805	VISHAY, CRCW08051M00FKEA
3	1	R2	RES., CHIP, 523k, 1% 0805	VISHAY, CRCW0805523KFKEA
4	0	R3 (OPEN)	RES., 0805	
5	1	R4	RES., CHIP, 0 Ω , 1% 0805	VISHAY, CRCW08050000Z0EA
6	1	R5	RES., CHIP, 100k, 1% 0805	VISHAY, CRCW0805100KFKEA
7	0	R6 (OPEN)	RES., 0805	
8	1	RSET	RES., CHIP, 154k, 1% 0805	VISHAY, CRCW0805154KFKEA
9	1	U1	IC., TimerBlox FAMILY SOT-23	LINEAR TECH., LTC6993CS6-4
DC1562B-K				
1	1	DC1562B	GENERAL BOM	
3	1	R1	RES., CHIP, 523k, 1% 0805	VISHAY, CRCW0805523KFKEA
2	1	R2	RES., CHIP, 1M, 1% 0805	VISHAY, CRCW08051M00FKEA
4	0	R3 (OPEN)	RES., 0805	
5	1	R4	RES., CHIP, 0 Ω , 1% 0805	VISHAY, CRCW08050000Z0EA
6	1	R5	RES., CHIP, 100k, 1% 0805	VISHAY, CRCW0805100KFKEA
7	0	R6 (OPEN)	RES., 0805	
8	1	RSET	RES., CHIP, 154K, 1% 0805	VISHAY, CRCW0805154KFKEA
9	1	U1	IC., TimerBlox FAMILY SOT-23	LINEAR TECH., LTC6994CS6-1
DC1562B-L				
1	1	DC1562B	GENERAL BOM	
2	1	R1	RES., CHIP, 1M, 1% 0805	VISHAY, CRCW08051M00FKEA
3	1	R2	RES., CHIP, 523k, 1% 0805	VISHAY, CRCW0805523KFKEA
4	0	R3 (OPEN)	RES., 0805	
5	1	R4	RES., CHIP, 0 Ω , 1% 0805	VISHAY, CRCW08050000Z0EA
6	1	R5	RES., CHIP, 100k, 1% 0805	VISHAY, CRCW0805100KFKEA
7	0	R6 (OPEN)	RES., 0805	
8	1	RSET	RES., CHIP, 154k, 1% 0805	VISHAY, CRCW0805154KFKEA
9	1	U1	IC., TimerBlox FAMILY SOT-23	LINEAR TECH., LTC6994CS6-2
DC1562B-M				
1	1	DC1562B	GENERAL BOM	
2	1	R1	RES., CHIP, 1M, 1% 0805	VISHAY, CRCW08051M00FKEA
3	1	R2	RES., CHIP, 280k, 1% 0805	
4	0	R3 (OPEN)	RES., 0805	
5	1	R4	RES., CHIP, 0 Ω , 1% 0805	VISHAY, CRCW08050000Z0EA
6	1	R5	RES., CHIP, 100k, 1% 0805	VISHAY, CRCW0805100KFKEA
7	1	R6	RES., CHIP, 191k, 1% 0805	
8	0	RSET (OPEN)	RES., 0805	
9	1	U1	IC., TimerBlox FAMILY SOT-23	LINEAR TECH., LTC6995CS6-1
DC1562B-N				
1	1	DC1562B	GENERAL BOM	
2	1	R1	RES., CHIP, 1M, 1% 0805	VISHAY, CRCW08051M00FKEA
3	1	R2	RES., CHIP, 280k, 1% 0805	
4	0	R3	RES., CHIP, 100k, 1% 0805	
5	1	R4	RES., CHIP, 0 Ω , 1% 0805	VISHAY, CRCW08050000Z0EA
6	1	R5 (OPEN)	RES., 0805	
7	0	R6	RES., CHIP, 191k, 1% 0805	
8	0	RSET	RES., 0805	
9	1	U1	IC., TimerBlox FAMILY SOT-23	LINEAR TECH., LTC6995CS6-2

dc1562bfa

SCHEMATIC DIAGRAM

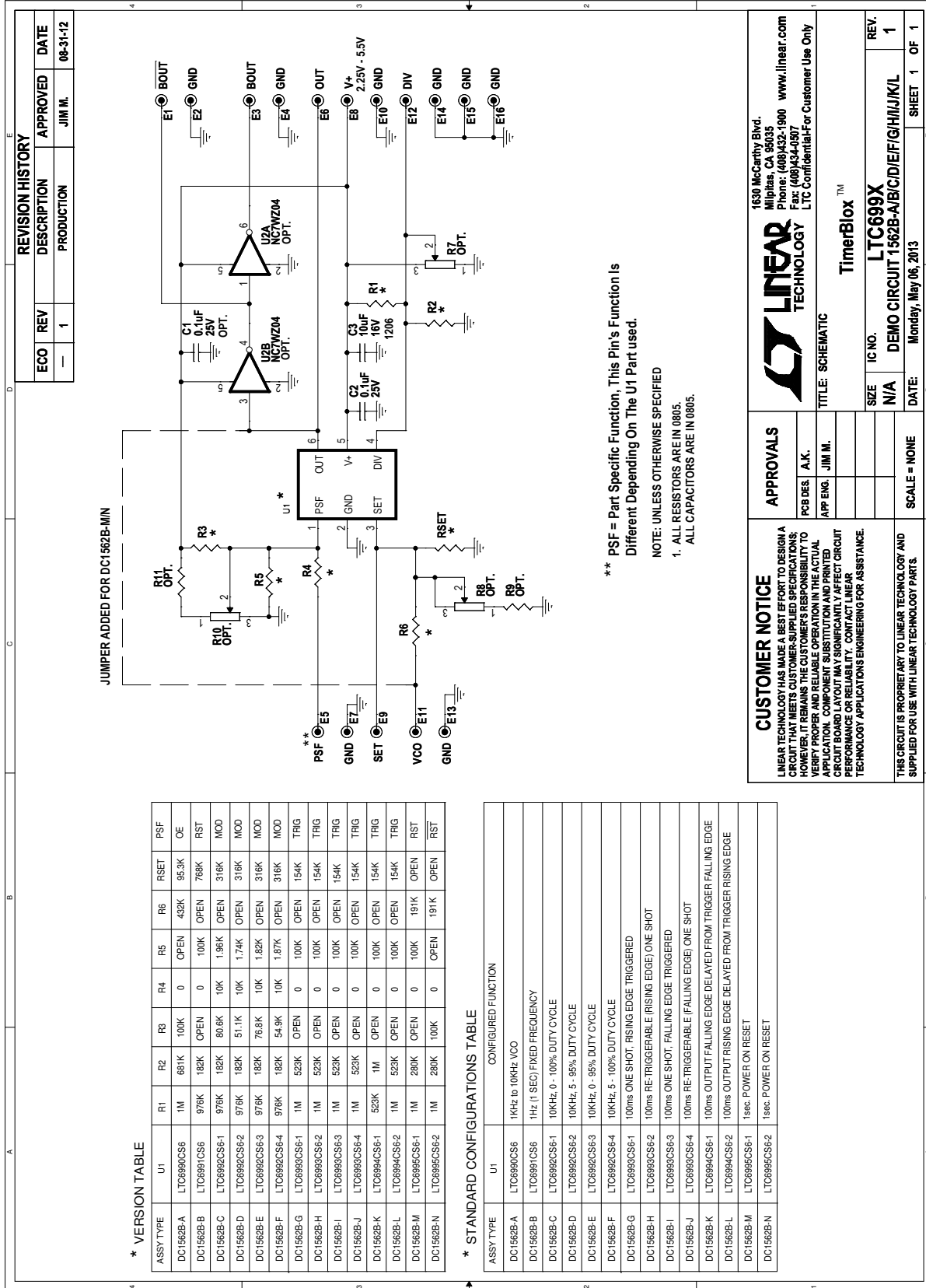

Information furnished by Linear Technology Corporation is believed to be accurate and reliable. However, no responsibility is assumed for its use. Linear Technology Corporation makes no representation that the interconnection of its circuits as described herein will not infringe on existing patent rights.

DEMO MANUAL DC1562B

DEMONSTRATION BOARD IMPORTANT NOTICE

Linear Technology Corporation (LTC) provides the enclosed product(s) under the following **AS IS** conditions:

This demonstration board (DEMO BOARD) kit being sold or provided by Linear Technology is intended for use for **ENGINEERING DEVELOPMENT OR EVALUATION PURPOSES ONLY** and is not provided by LTC for commercial use. As such, the DEMO BOARD herein may not be complete in terms of required design-, marketing-, and/or manufacturing-related protective considerations, including but not limited to product safety measures typically found in finished commercial goods. As a prototype, this product does not fall within the scope of the European Union directive on electromagnetic compatibility and therefore may or may not meet the technical requirements of the directive, or other regulations.

If this evaluation kit does not meet the specifications recited in the DEMO BOARD manual the kit may be returned within 30 days from the date of delivery for a full refund. **THE FOREGOING WARRANTY IS THE EXCLUSIVE WARRANTY MADE BY THE SELLER TO BUYER AND IS IN LIEU OF ALL OTHER WARRANTIES, EXPRESSED, IMPLIED, OR STATUTORY, INCLUDING ANY WARRANTY OF MERCHANTABILITY OR FITNESS FOR ANY PARTICULAR PURPOSE. EXCEPT TO THE EXTENT OF THIS INDEMNITY, NEITHER PARTY SHALL BE LIABLE TO THE OTHER FOR ANY INDIRECT, SPECIAL, INCIDENTAL, OR CONSEQUENTIAL DAMAGES.**

The user assumes all responsibility and liability for proper and safe handling of the goods. Further, the user releases LTC from all claims arising from the handling or use of the goods. Due to the open construction of the product, it is the user's responsibility to take any and all appropriate precautions with regard to electrostatic discharge. Also be aware that the products herein may not be regulatory compliant or agency certified (FCC, UL, CE, etc.).

No License is granted under any patent right or other intellectual property whatsoever. **LTC assumes no liability for applications assistance, customer product design, software performance, or infringement of patents or any other intellectual property rights of any kind.**

LTC currently services a variety of customers for products around the world, and therefore this transaction **is not exclusive**.

Please read the DEMO BOARD manual prior to handling the product. Persons handling this product must have electronics training and observe good laboratory practice standards. **Common sense is encouraged.**

This notice contains important safety information about temperatures and voltages. For further safety concerns, please contact a LTC application engineer.

Mailing Address:

Linear Technology
1630 McCarthy Blvd.
Milpitas, CA 95035

Copyright © 2004, Linear Technology Corporation

Компания «Life Electronics» занимается поставками электронных компонентов импортного и отечественного производства от производителей и со складов крупных дистрибьюторов Европы, Америки и Азии.

С конца 2013 года компания активно расширяет линейку поставок компонентов по направлению коаксиальный кабель, кварцевые генераторы и конденсаторы (керамические, пленочные, электролитические), за счёт заключения дистрибьюторских договоров

Мы предлагаем:

- Конкурентоспособные цены и скидки постоянным клиентам.
- Специальные условия для постоянных клиентов.
- Подбор аналогов.
- Поставку компонентов в любых объемах, удовлетворяющих вашим потребностям.
- Приемлемые сроки поставки, возможна ускоренная поставка.
- Доставку товара в любую точку России и стран СНГ.
- Комплексную поставку.
- Работу по проектам и поставку образцов.
- Формирование склада под заказчика.
- Сертификаты соответствия на поставляемую продукцию (по желанию клиента).
- Тестирование поставляемой продукции.
- Поставку компонентов, требующих военную и космическую приемку.
- Входной контроль качества.
- Наличие сертификата ISO.

В составе нашей компании организован Конструкторский отдел, призванный помогать разработчикам, и инженерам.

Конструкторский отдел помогает осуществить:

- Регистрацию проекта у производителя компонентов.
- Техническую поддержку проекта.
- Защиту от снятия компонента с производства.
- Оценку стоимости проекта по компонентам.
- Изготовление тестовой платы монтаж и пусконаладочные работы.



Тел: +7 (812) 336 43 04 (многоканальный)

Email: org@lifeelectronics.ru