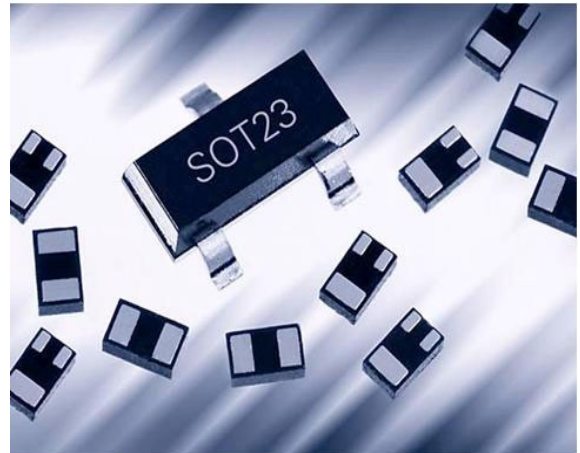
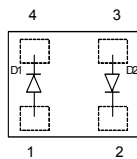
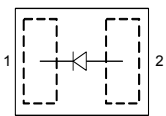

**Silicon Deep Trench PIN Diodes**

- Optimized for low bias current antenna switches in hand held applications
- Very low capacitance at zero volt reverse bias at frequencies above 1GHz (typ. 0.19 pF)
- Low forward resistance (typ.  $1.3 \Omega$  @  $I_F = 3 \text{ mA}$ )
- Improved ON / OFF mode harmonic distortion balance
- Pb-free (RoHS compliant) package

**BAR90-02EL**  
**BAR90-02ELS**
**BAR90-098LRH**

Type	Package	Configuration	$L_S$ (nH)	Marking
BAR90-02ELS	TSSLP-2-3	single, leadless	0.2	J*
BAR90-02EL	TSLP-2-19	single, leadless	0.4	X
BAR90-098LRH	TSLP-4-7	anti-parallel pair, leadless	0.4	T9

\* Marking of TSSLP-2-3 with underline

**Maximum Ratings at  $T_A = 25^\circ\text{C}$ , unless otherwise specified**

Parameter	Symbol	Value	Unit
Diode reverse voltage	$V_R$	80	V
Forward current	$I_F$	100	mA
Total power dissipation	$P_{tot}$		mW
$T_S \leq 137^\circ\text{C}$ , BAR90-02ELS		150	
$T_S \leq 133^\circ\text{C}$ , all others		250	
Junction temperature	$T_j$	150	$^\circ\text{C}$
Operating temperature range	$T_{op}$	-55 ... 125	
Storage temperature	$T_{stg}$	-55 ... 150	

**Thermal Resistance**

Parameter	Symbol	Value	Unit
Junction - soldering point <sup>1)</sup>	$R_{thJS}$		K/W
BAR90-02ELS		≤ 90	
All others		≤ 65	

**Electrical Characteristics at  $T_A = 25^\circ\text{C}$ , unless otherwise specified**

Parameter	Symbol	Values			Unit
		min.	typ.	max.	

**DC Characteristics**

Breakdown voltage $I_{(BR)} = 5 \mu\text{A}$	$V_{(BR)}$	80	-	-	V
Reverse current $V_R = 60 \text{ V}$	$I_R$	-	-	50	nA
Forward voltage $I_F = 3 \text{ mA}$ $I_F = 100 \text{ mA}$	$V_F$	0.75 -	0.81 0.9	0.87 1	V

<sup>1)</sup>For calculation of  $R_{thJA}$  please refer to Application Note AN077 (Thermal Resistance Calculation)

**Electrical Characteristics at  $T_A = 25^\circ\text{C}$ , unless otherwise specified**

Parameter	Symbol	Values			Unit
		min.	typ.	max.	
<b>AC Characteristics</b>					
Diode capacitance $V_R = 1\text{ V}, f = 1\text{ MHz}$ $V_R = 0\text{ V}, f = 100\text{ MHz}$ $V_R = 0\text{ V}, f = 1\text{ GHz}$ $V_R = 0\text{ V}, f = 1.8\text{ GHz}$	$C_T$	- - - -	0.25 0.3 0.19 0.18	0.35 - - -	pF
Reverse parallel resistance $V_R = 0\text{ V}, f = 100\text{ MHz}$ $V_R = 0\text{ V}, f = 1\text{ GHz}$ $V_R = 0\text{ V}, f = 1.8\text{ GHz}$	$R_P$	- - -	35 5 4	- - -	k $\Omega$
Forward resistance $I_F = 1\text{ mA}, f = 100\text{ MHz}$ $I_F = 3\text{ mA}, f = 100\text{ MHz}$ $I_F = 10\text{ mA}, f = 100\text{ MHz}$	$r_f$	- - -	2 1.3 0.8	- 2.3 -	$\Omega$
Charge carrier life time $I_F = 10\text{ mA}, I_R = 6\text{ mA}$ , measured at $I_R = 3\text{ mA}$ , $R_L = 100\ \Omega$	$\tau_{rr}$	-	750	-	ns
I-region width	$W_I$	-	20	-	$\mu\text{m}$
Insertion loss <sup>1)</sup> $I_F = 1\text{ mA}, f = 1.8\text{ GHz}$ $I_F = 3\text{ mA}, f = 1.8\text{ GHz}$ $I_F = 10\text{ mA}, f = 1.8\text{ GHz}$	$I_L$	- - -	0.16 0.11 0.08	- - -	dB
Isolation <sup>1)</sup> $V_R = 0\text{ V}, f = 0.9\text{ GHz}$ $V_R = 0\text{ V}, f = 1.8\text{ GHz}$ $V_R = 0\text{ V}, f = 2.45\text{ GHz}$	$I_{SO}$	- - -	18.5 13.5 11.5	- - -	

<sup>1)</sup>BAR90-02EL in series configuration,  $Z = 50\ \Omega$

**Diode capacitance  $C_T = f(V_R)$**

$f =$  Parameter

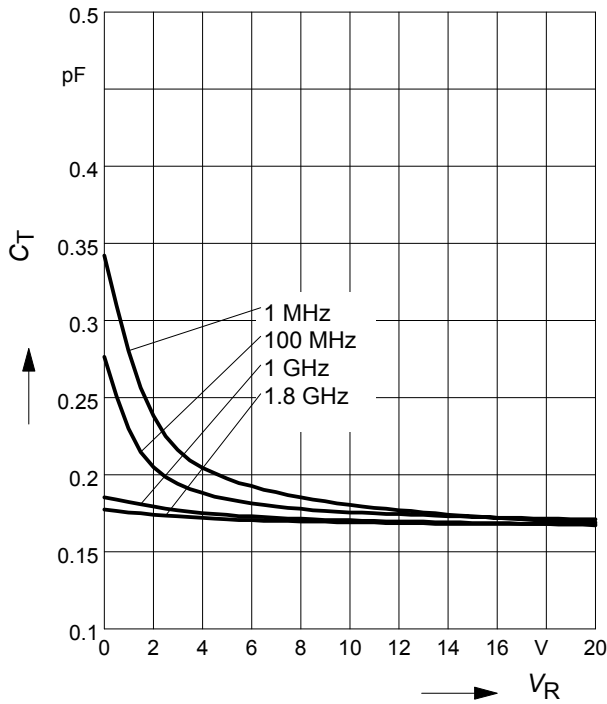

**Reverse parallel resistance  $R_P = f(V_R)$**

$f =$  Parameter

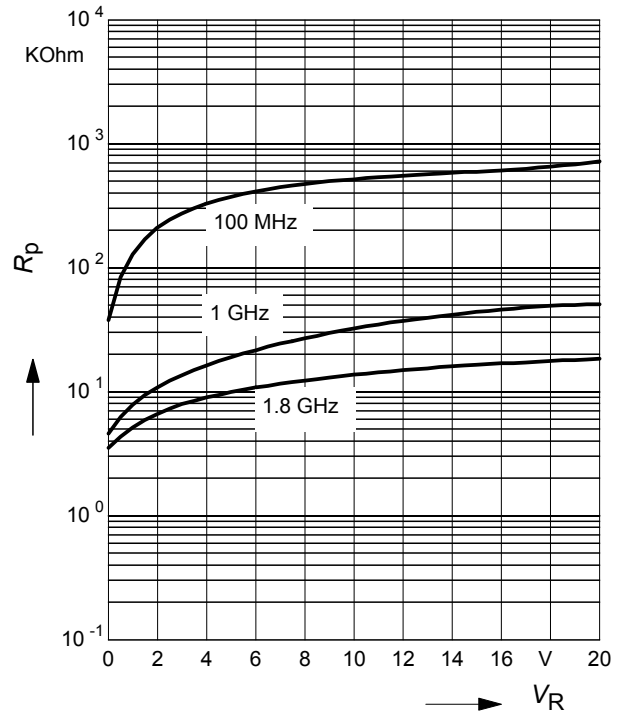

**Forward resistance  $r_f = f(I_F)$**

$f = 100$  MHz

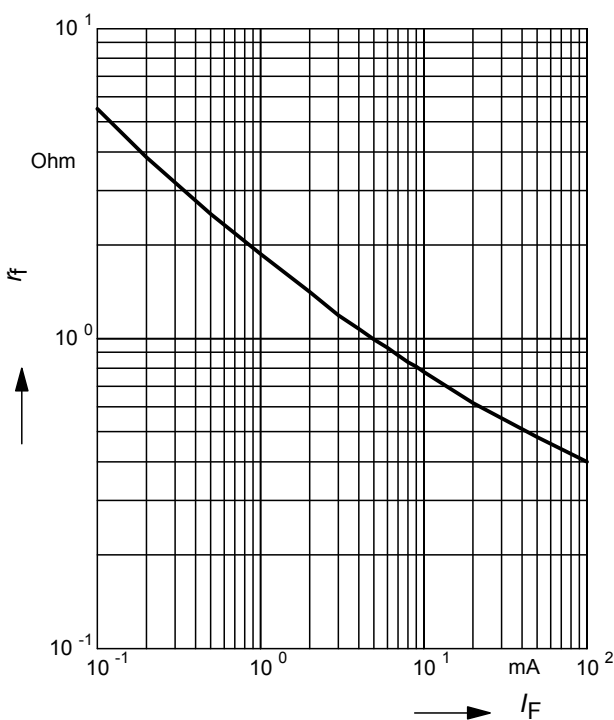

**Forward current  $I_F = f(V_F)$**

$T_A =$  Parameter

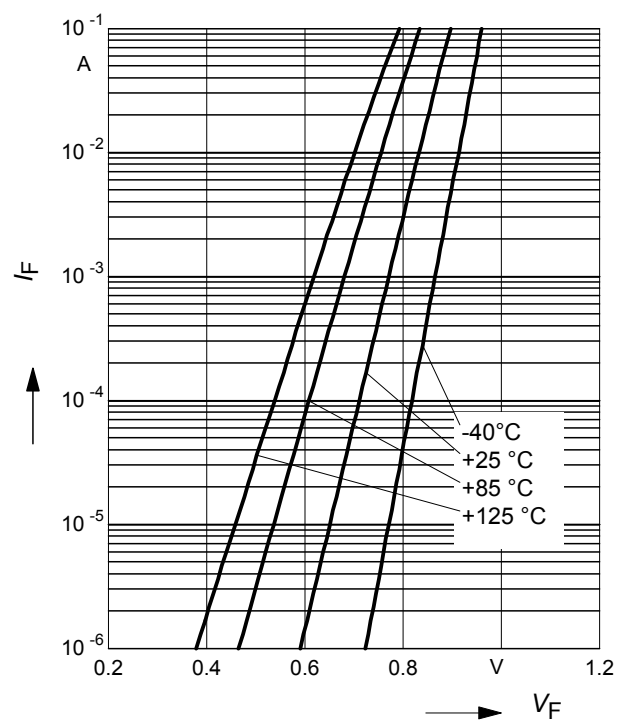

**Forward current  $I_F = f(T_S)$**

BAR90-02EL / -098LRH

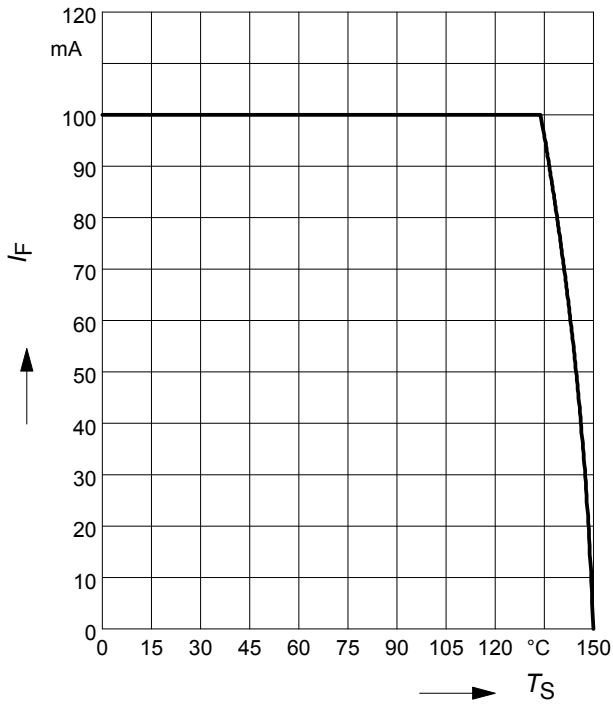

**Forward current  $I_F = f(T_S)$**

BAR90-02ELS

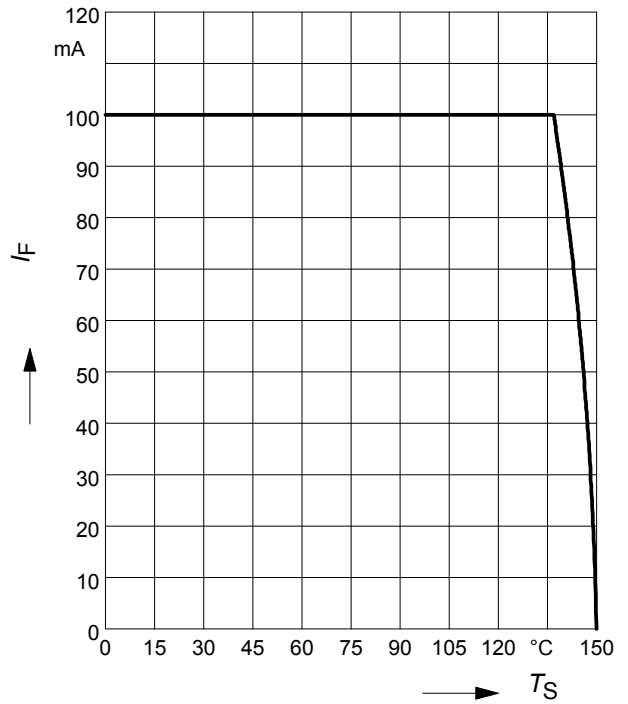

**Permissible Puls Load  $R_{thJS} = f(t_p)$**

BAR90-02EL / -098LRH

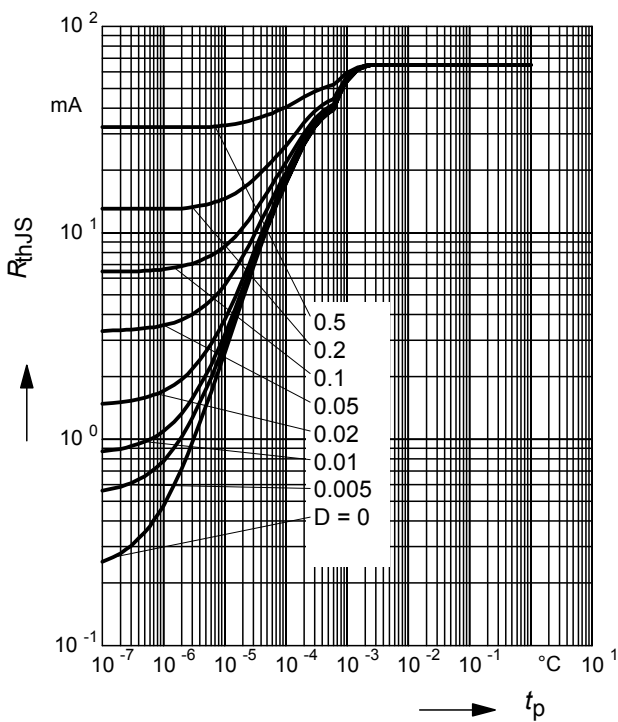

**Permissible Pulse Load**

$I_{Fmax} / I_{FDC} = f(t_p)$  BAR90-02EL / -098LRH

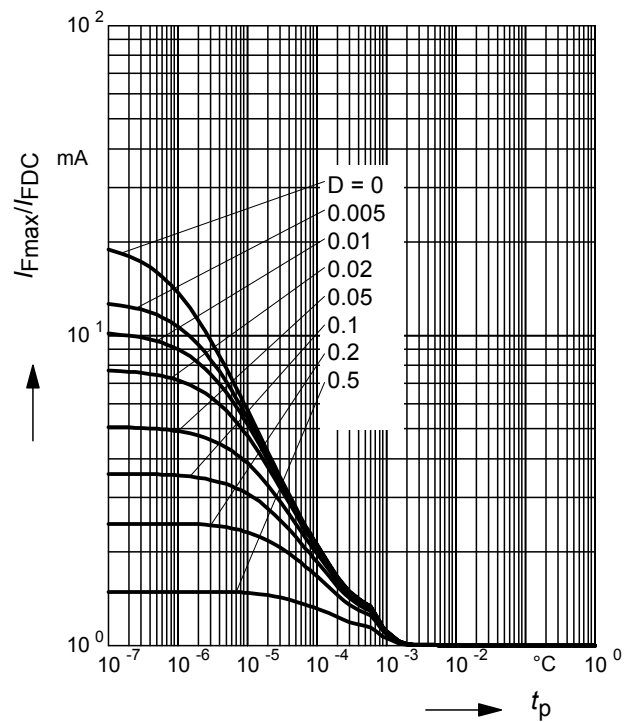

**Permissible Puls Load  $R_{thJS} = f(t_p)$**

BAR90-02ELS

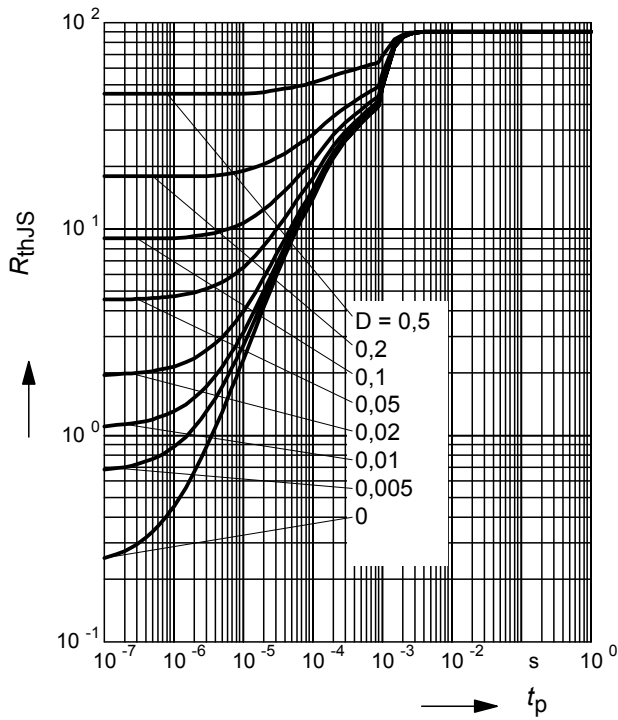

**Permissible Pulse Load**

$I_{Fmax} / I_{FDC} = f(t_p)$

BAR90-02ELS

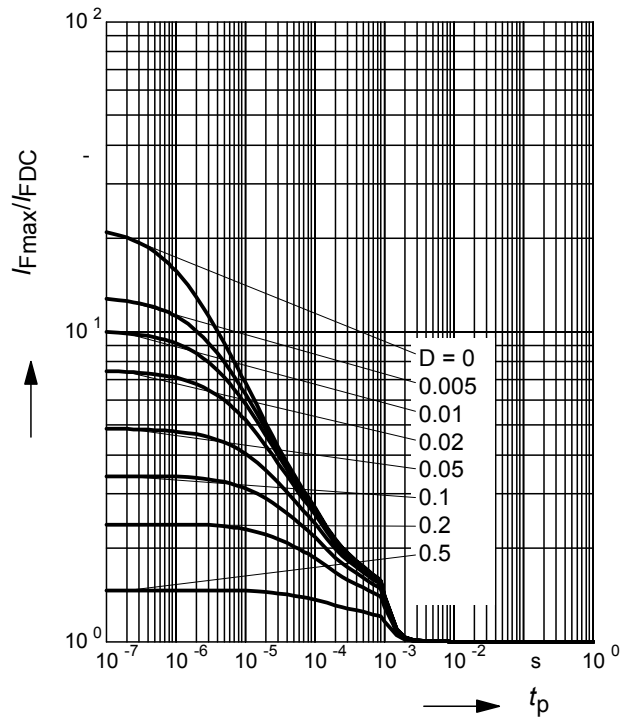

**Insertion loss  $I_L = -|S_{21}|^2 = f(f)$**

$I_F$  = Parameter

BAR90-02EL in series configuration,  $Z = 50\Omega$

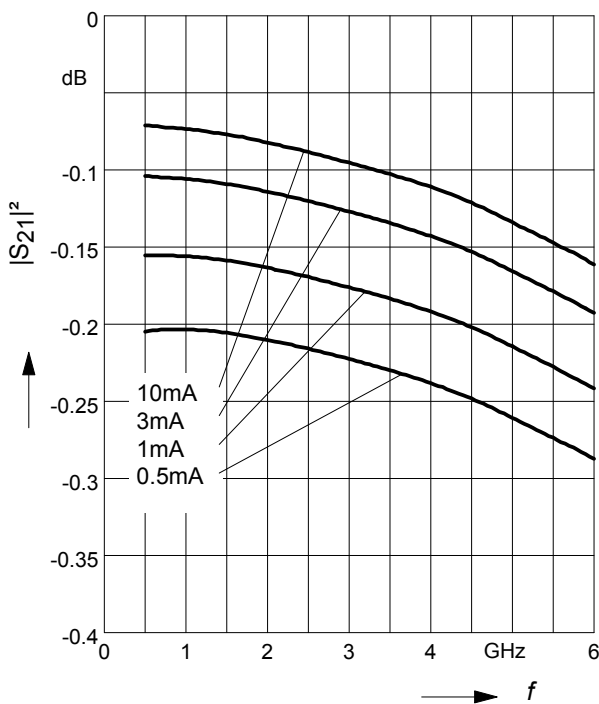

**Isolation  $I_{SO} = -|S_{21}|^2 = f(f)$**

$V_R$  = Parameter

BAR90-02EL in series configuration,  $Z = 50\Omega$

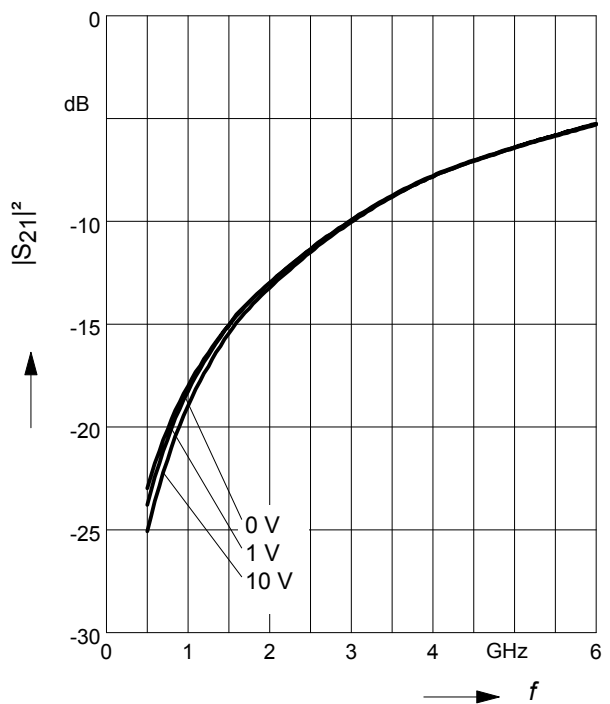

Package Outline

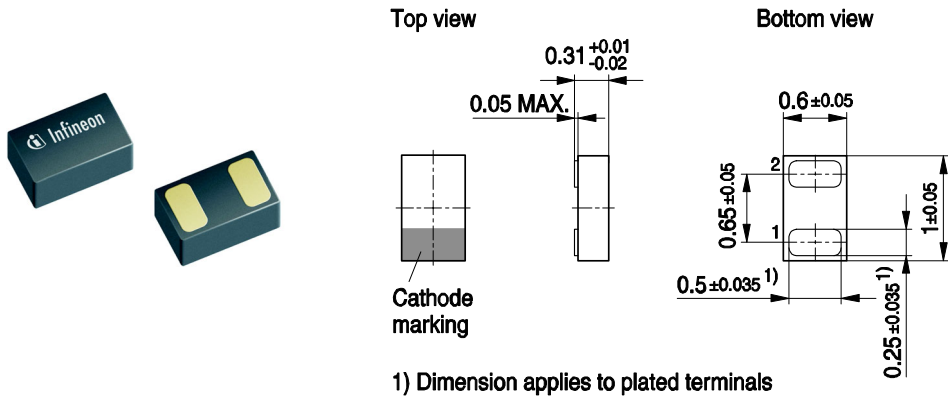

TSLP-2-19, -20-PO V01

Foot Print

For board assembly information please refer to Infineon website „Packages“

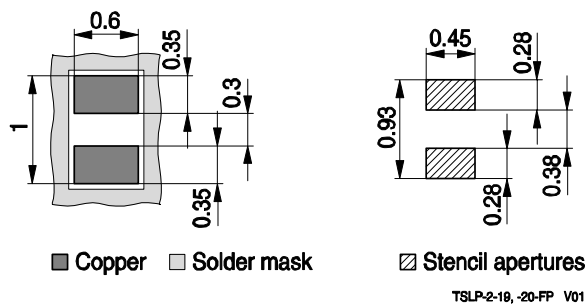

TSLP-2-19, -20-FP V01

Marking layout (Example)

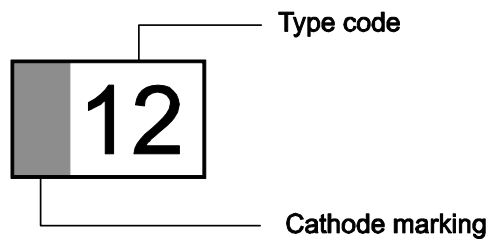

Standard Packing

Reel Ø 180 mm: 15.000 Pieces / Reel  
 Reel Ø 330 mm: 6.000 Pieces / Reel  
 Reel Ø 330 mm: 50.000 Pieces / Reel

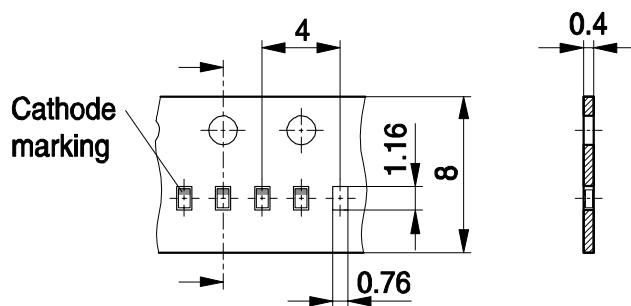

TSLP-2-19, -20-TP V02

### Package Outline

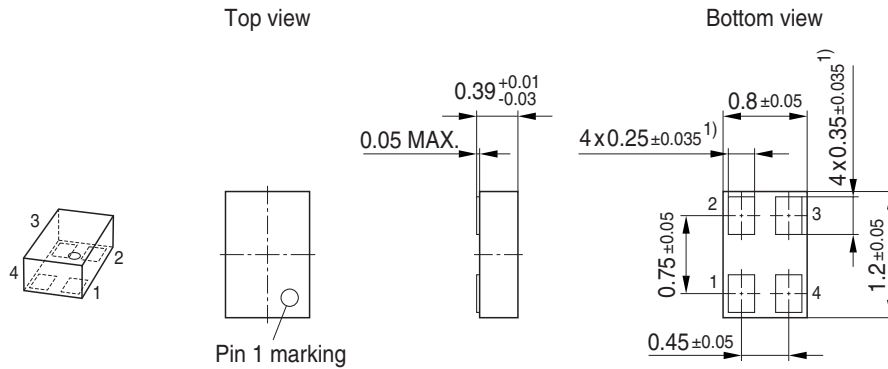

1) Dimension applies to plated terminal

### Foot Print

For board assembly information please refer to Infineon website "Packages"

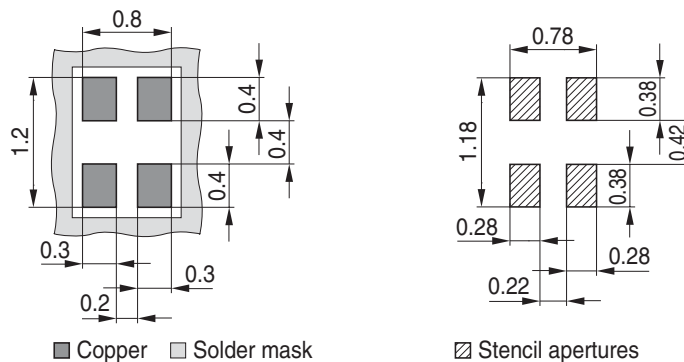

### Marking Layout (Example)

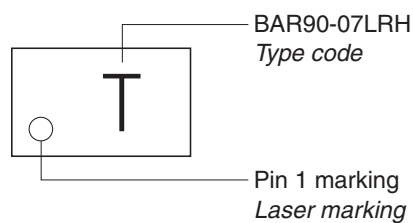

### Standard Packing

Reel  $\varnothing$ 180 mm = 15.000 Pieces/Reel

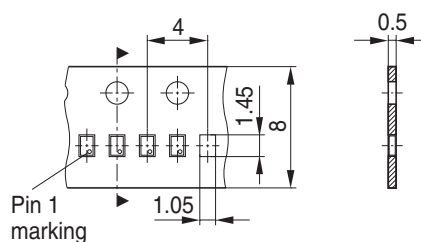



### Package Outline

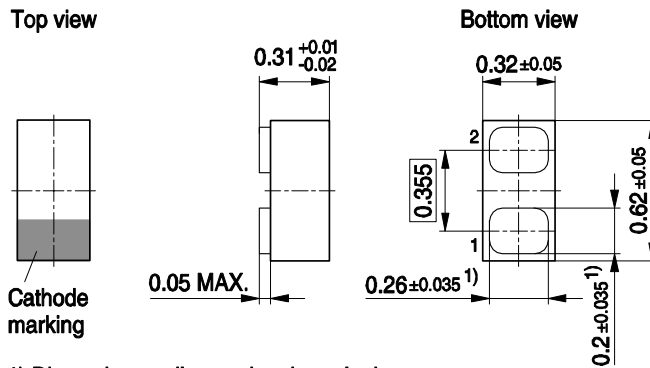

1) Dimension applies to plated terminals

### Foot Print

For board assembly information please refer to Infineon website "Packages"

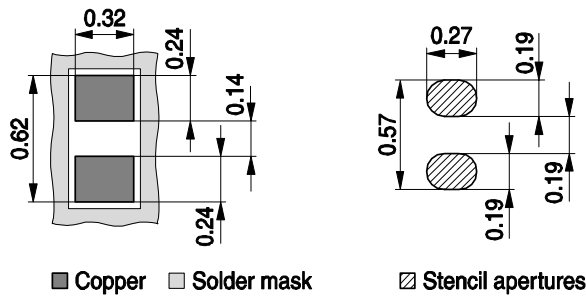

### Marking Layout

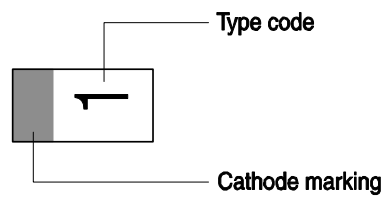

### Standard Packing

Reel ø330 mm = 15.000 Pieces/Reel

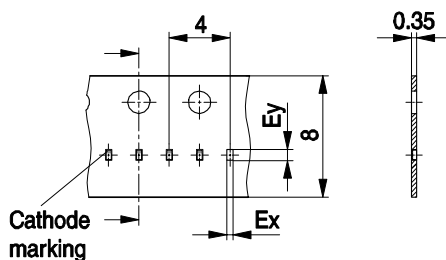

Tape type	Ex	Ey
Punched Tape	0.43	0.73
Embossed Tape	0.37	0.67

Deliveries can be both tape types (no selection possible).  
Specification allows identical processing (pick & place) by users.

**Edition 2009-11-16**

**Published by  
Infineon Technologies AG  
81726 Munich, Germany**

**© 2009 Infineon Technologies AG  
All Rights Reserved.**

### **Legal Disclaimer**

The information given in this document shall in no event be regarded as a guarantee of conditions or characteristics. With respect to any examples or hints given herein, any typical values stated herein and/or any information regarding the application of the device, Infineon Technologies hereby disclaims any and all warranties and liabilities of any kind, including without limitation, warranties of non-infringement of intellectual property rights of any third party.

### **Information**

For further information on technology, delivery terms and conditions and prices, please contact the nearest Infineon Technologies Office ([<www.infineon.com>](http://www.infineon.com)).

### **Warnings**

Due to technical requirements, components may contain dangerous substances. For information on the types in question, please contact the nearest Infineon Technologies Office.

Infineon Technologies components may be used in life-support devices or systems only with the express written approval of Infineon Technologies, if a failure of such components can reasonably be expected to cause the failure of that life-support device or system or to affect the safety or effectiveness of that device or system. Life support devices or systems are intended to be implanted in the human body or to support and/or maintain and sustain and/or protect human life. If they fail, it is reasonable to assume that the health of the user or other persons may be endangered.

Компания «Life Electronics» занимается поставками электронных компонентов импортного и отечественного производства от производителей и со складов крупных дистрибьюторов Европы, Америки и Азии.

С конца 2013 года компания активно расширяет линейку поставок компонентов по направлению коаксиальный кабель, кварцевые генераторы и конденсаторы (керамические, пленочные, электролитические), за счёт заключения дистрибьюторских договоров

Мы предлагаем:

- Конкуренспособные цены и скидки постоянным клиентам.
- Специальные условия для постоянных клиентов.
- Подбор аналогов.
- Поставку компонентов в любых объемах, удовлетворяющих вашим потребностям.
- Приемлемые сроки поставки, возможна ускоренная поставка.
- Доставку товара в любую точку России и стран СНГ.
- Комплексную поставку.
- Работу по проектам и поставку образцов.
- Формирование склада под заказчика.
- Сертификаты соответствия на поставляемую продукцию (по желанию клиента).
- Тестирование поставляемой продукции.
- Поставку компонентов, требующих военную и космическую приемку.
- Входной контроль качества.
- Наличие сертификата ISO.

В составе нашей компании организован Конструкторский отдел, призванный помогать разработчикам, и инженерам.

Конструкторский отдел помогает осуществить:

- Регистрацию проекта у производителя компонентов.
- Техническую поддержку проекта.
- Защиту от снятия компонента с производства.
- Оценку стоимости проекта по компонентам.
- Изготовление тестовой платы монтаж и пусконаладочные работы.



Тел: +7 (812) 336 43 04 (многоканальный)

Email: [org@lifeelectronics.ru](mailto:org@lifeelectronics.ru)