

High-Stability & Ultra-Low Phase Noise SMD OCXO/VCOCXO

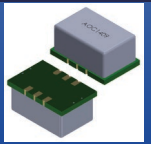

AOC1409 Series



ESD Sensitive 

14.9 x 9.7 x 7.0mm
RoHS/RoHS II Compliant
MSL = 1

Features

- Extremely low long-term aging: ± 700 ppb over 20 years
- Stability over temperature: ± 10 ppb over -40°C to $+85^{\circ}\text{C}$
- Excellent phase noise:
(-138 dBc/Hz typ. @ 100Hz offset, -148 dBc/Hz typ. @ 1kHz offset)
- 20.0MHz carrier frequency
- 14.9 x 9.7mm, 6-pin SMD reflow-solderable package
- 3.3 V_{dd} supply
- SC-Cut, High “Q” resonator-based design

Applications

- Stratum 3 & Stratum 3E compliant
- Cellular infrastructure; Base stations
- Test & measurement equipment
- Switches & routers
- Time & frequency references
- Precision GPS

Part Identification

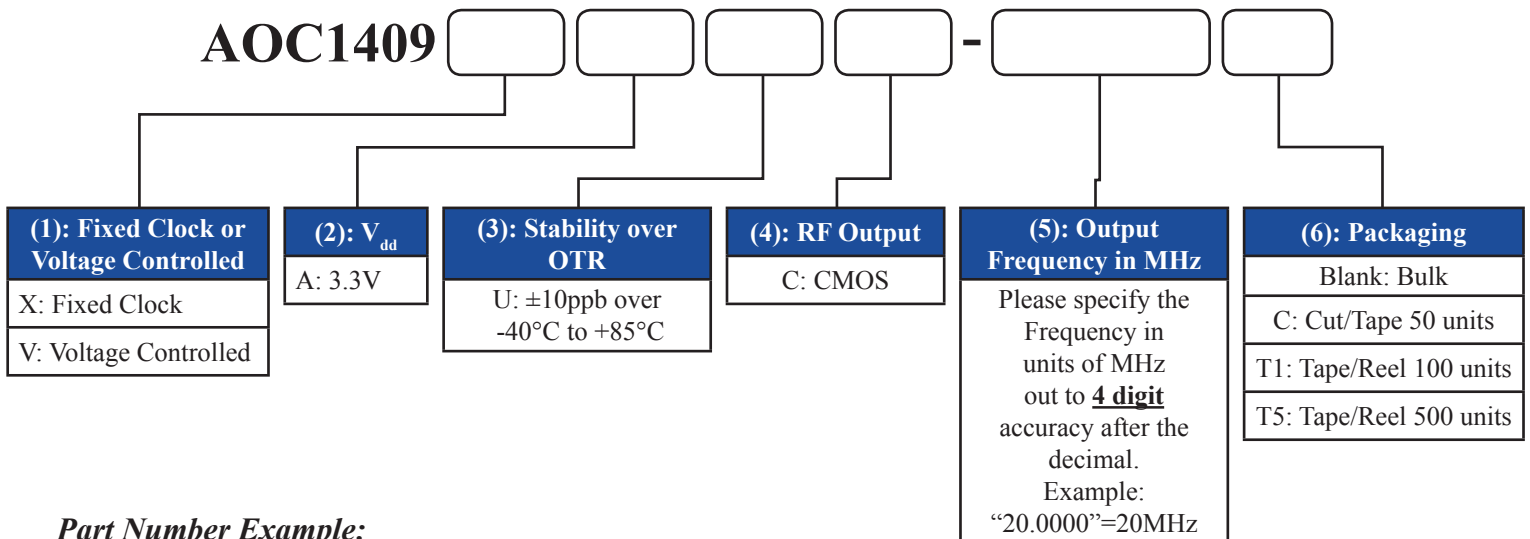

Part Number Example:
AOC1409VAUC-20.0000C

High-Stability & Ultra-Low Phase Noise SMD OCXO/VCOCXO



AOC1409 Series



ESD Sensitive 

14.9 x 9.7 x 7.0mm
RoHS/RoHS II Compliant
MSL = 1

Electrical Specifications

Parameters	Min.	Typical	Max.	Unit	Notes
Frequency (Fc)	20.0000			MHz	
Operating Temperature Range	-40		+85	°C	
Storage Temperature Range	-40		+100	°C	
Supply Voltage (V _{dd})	+3.135	+3.3	+3.465	V	
Power Consumption (warm-up)			2.5	W	
Current Consumption (warm-up)			722	mA	@ Max V _{dd} = +3.465V
Power Consumption (steady-state @+25°C)			1.0	W	
Current Consumption (steady-state @+25°C)			289	mA	@ Max V _{dd} = +3.465V
Frequency Accuracy (calibration)		≤ ±100	±200	ppb	See Note 1
Frequency Stability over Operating Temperature Range			±10.0	ppb	See Note 2
Frequency Stability vs. Supply Voltage Change			±5.0	ppb	V _{dd} ±5%; (V _c =constant)
Frequency Stability vs. Load Change			±2.0	ppb	Load=15pF±10%
Aging Daily			±1.0	ppb	
Aging 1 st Year			±100	ppb	
Aging 20 Years			±500	ppb	
All-Inclusive Frequency Tolerance over 20 Year Product Life			±700	ppb	See Note 3
Warm-Up Time			3	min.	See Note 4
Output Signal	LVCMOS				
Output Load	13.5	15	16.5	pF	
Duty Cycle	45	50	55	%	@ 50% V _{dd}
Output High Voltage (V _{OH})	V _{OH}	0.9*(V _{dd})		V	Load=15pF±10%; V _{dd} =+3.3V
Output Low Voltage (V _{OL})	V _{OL}		0.1*(V _{dd})		
Rise (Tr) / Fall (Tf) Time			6	ns	
Center Control Voltage (V _c)		+1.65		V	Voltage-Controlled Option (VCOCXO)
Control Voltage Range	+0.0		+3.3	V	
Frequency Pullability	±0.7			ppm	
Control Port Input Impedance	100			kΩ	
EFC Linearity			±10	%	
Tuning Slope	Positive Monotonic				
Phase Noise (@ 25 °C)		-85		dBc/Hz	Offset @1Hz
		-115			Offset @10Hz
		-138			Offset @100Hz
		-148			Offset @1kHz
		-152			Offset @10kHz
		-154			Offset @100kHz

Note 1: @ +25°C; initial set-tolerance frequency (relative to carrier) at time of shipment, pre-reflow

Note 2: Over -40°C to +85°C; relative to stabilized frequency after 1 hour of continuous operation, post-reflow

Note 3: Over -40°C to +85°C; includes stability over temperature, initial frequency accuracy (calibration), load pulling, power supply variation, and 20 years aging

Note 4: @ +25°C; within ±10ppb of F, where F is the stabilized frequency reached after 1 hour of continuous operation



5101 Hidden Creek Ln Spicewood TX 78669
Phone: 512-371-6159 | Fax: 512-351-8858
For terms and conditions of sales, please visit:
www.abracon.com

REVISED: 03-19-19

ABRACON IS
ISO9001-2015
CERTIFIED

High-Stability & Ultra-Low Phase Noise SMD OCXO/VCOCXO

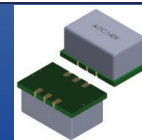

AOC1409 Series



ESD Sensitive 

14.9 x 9.7 x 7.0mm
RoHS/RoHS II Compliant
MSL = 1

Mechanical Dimensions

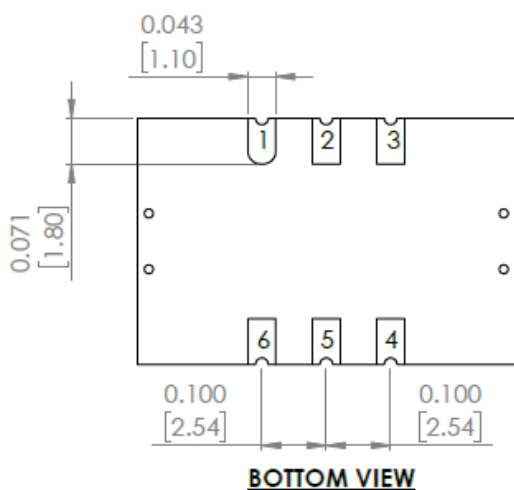
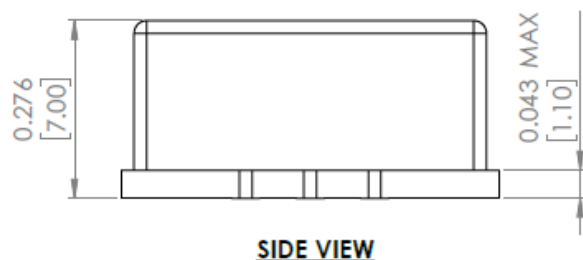
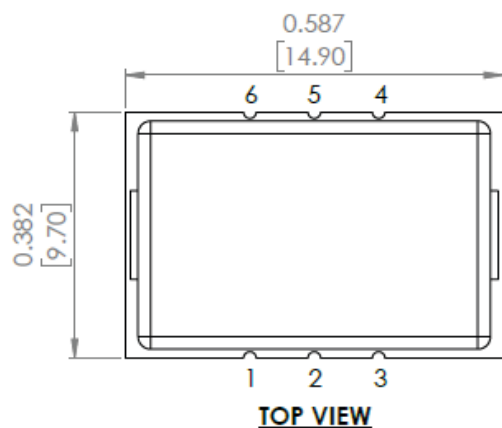

RECOMMENDED LAND PATTERN

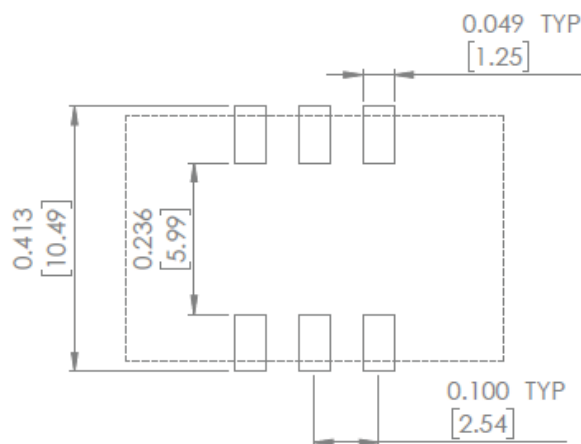

Pin #	Function
#1	Option V: Voltage-Control (Vc) Option X: No Connect
#2	Do Not Connect (DNC) ^[Note 5]
#3	GROUND
#4	Output
#5	Do Not Connect (DNC) ^[Note 5]
#6	Supply Voltage (V _{dd})

Dimensions: inches [mm]

Note 5: Do not electrically connect pins #2 & #5 as they are for factory use only.



5101 Hidden Creek Ln Spicewood TX 78669
Phone: 512-371-6159 | Fax: 512-351-8858
For terms and conditions of sales, please visit:
www.abracon.com

REVISED: 03-19-19

ABRACON IS
ISO9001-2015
CERTIFIED

High-Stability & Ultra-Low Phase Noise SMD OCXO/VCOCXO



AOC1409 Series



ESD Sensitive

14.9 x 9.7 x 7.0mm
RoHS/RoHS II Compliant
MSL = 1

Recommended Reflow Profile ^[Note 6]

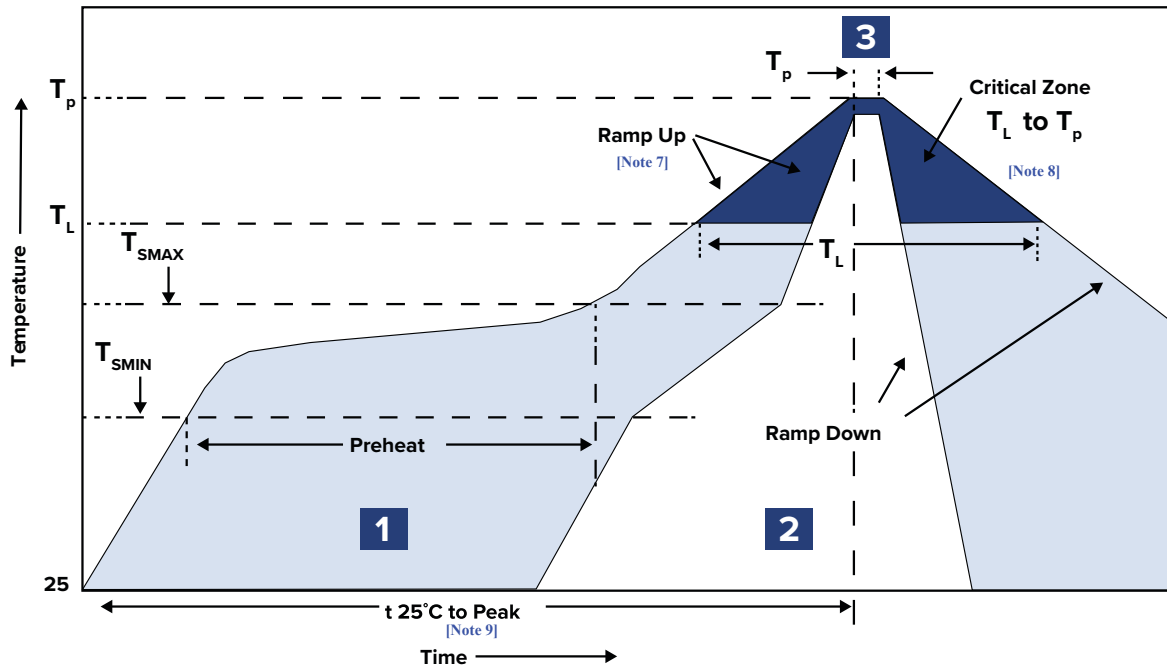

Zone	Description	Temperature	Time
1	Preheat / Soak	$T_{SMIN} \sim T_{SMAX}$ 150°C ~ 200°C	60 ~ 180 sec.
2	Reflow	T_L 217°C	60 ~ 150 sec.
3	Peak heat	T_P 260°C±5°C	20 ~ 40 sec.

Note 6: Can withstand 2 times reflow; all temperatures refer to topside of the package, measured on the package body surface

Note 7: Ramp Up Rate ($T_L \rightarrow T_P$) = 3°C / sec. MAX

Note 8: Ramp Down Rate ($T_P \rightarrow T_L$) = 6°C / sec. MAX

Note 9: Time 25°C to Peak Temperature (25°C \rightarrow T_P) = 8 minutes MAX

High-Stability & Ultra-Low Phase Noise SMD OCXO/VCOCXO



AOC1409 Series



ESD Sensitive

14.9 x 9.7 x 7.0mm
RoHS/RoHS II Compliant
MSL = 1

Packaging ^[Note 10]

C = Cut Tape 50 units

T1 = Tape & Reel 100 units/reel

T5 = Tape & Reel 500 units/reel



Dimensions: mm

Note 10: 500 units = maximum quantity per 330mm reel

ATTENTION: Abracon LLC's products are COTS – Commercial-Off-The-Shelf products; suitable for Commercial, Industrial and, where designated, Automotive Applications. Abracon's products are not specifically designed for Military, Aviation, Aerospace, Life-dependent Medical applications or any application requiring high reliability where component failure could result in loss of life and/or property. For applications requiring high reliability and/or presenting an extreme operating environment, written consent and authorization from Abracon LLC is required. Please contact Abracon LLC for more information.



5101 Hidden Creek Ln Spicewood TX 78669
Phone: 512-371-6159 | Fax: 512-351-8858
For terms and conditions of sales, please visit:
www.abracon.com

REVISED: 03-19-19

ABRACON IS
ISO9001-2015
CERTIFIED

Компания «Life Electronics» занимается поставками электронных компонентов импортного и отечественного производства от производителей и со складов крупных дистрибьюторов Европы, Америки и Азии.

С конца 2013 года компания активно расширяет линейку поставок компонентов по направлению коаксиальный кабель, кварцевые генераторы и конденсаторы (керамические, пленочные, электролитические), за счёт заключения дистрибьюторских договоров

Мы предлагаем:

- Конкурентоспособные цены и скидки постоянным клиентам.
- Специальные условия для постоянных клиентов.
- Подбор аналогов.
- Поставку компонентов в любых объемах, удовлетворяющих вашим потребностям.
- Приемлемые сроки поставки, возможна ускоренная поставка.
- Доставку товара в любую точку России и стран СНГ.
- Комплексную поставку.
- Работу по проектам и поставку образцов.
- Формирование склада под заказчика.
- Сертификаты соответствия на поставляемую продукцию (по желанию клиента).
- Тестирование поставляемой продукции.
- Поставку компонентов, требующих военную и космическую приемку.
- Входной контроль качества.
- Наличие сертификата ISO.

В составе нашей компании организован Конструкторский отдел, призванный помогать разработчикам, и инженерам.

Конструкторский отдел помогает осуществить:

- Регистрацию проекта у производителя компонентов.
- Техническую поддержку проекта.
- Защиту от снятия компонента с производства.
- Оценку стоимости проекта по компонентам.
- Изготовление тестовой платы монтаж и пусконаладочные работы.



Тел: +7 (812) 336 43 04 (многоканальный)

Email: org@lifeelectronics.ru