

Description and Applications

The DML3006LFDS load switch provides a component and area-reducing solution for efficient power domain switching with inrush current limit via soft-start. In addition to integrated control functionality with ultra low on-resistance, this device offers system safeguards and monitoring via fault protection and power good signaling. This cost effective solution is ideal for power management and hot-swap applications requiring low power consumption in a small footprint.

- Portable Electronics and Systems
- Notebook and Tablet Computers
- Telecom, Networking, Medical, and Industrial Equipment
- Set-Top Boxes, Servers, and Gateways
- Hot-Swap Devices and Peripheral Ports

Features and Benefits

- Advanced Controller with ChargePump
- Integrated N-Channel MOSFET with Ultra Low R_{ON}
- Input Voltage Range 0.5V to 13.5V
- Soft-Start via Controlled SlewRate
- Power Good Signal
- Thermal Shutdown
- V_{IN} Under-Voltage Lockout
- Short-Circuit Protection
- Extremely Low Standby Current
- Load Bleed (Quick Discharge)
- **Totally Lead-Free & Fully RoHS Compliant (Notes 1 & 2)**
- **Halogen and Antimony Free. "Green" Device (Note 3)**

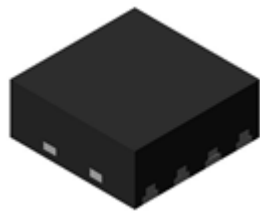

Top View

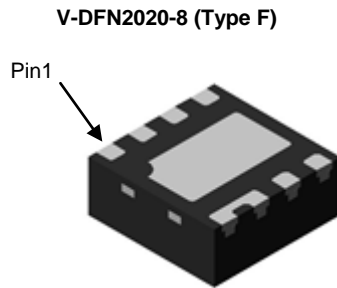

Bottom View

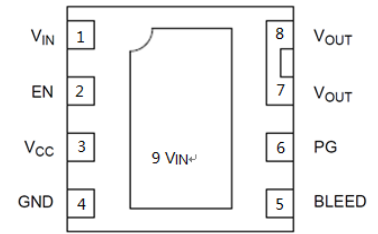

Top View

Ordering Information (Note 4)

Part Number	Case	Packaging
DML3006LFDS-7	V-DFN2020-8 (Type F)	3,000/Tape & Reel

- Notes:
1. No purposely added lead. Fully EU Directive 2002/95/EC (RoHS), 2011/65/EU (RoHS 2) & 2015/863/EU (RoHS 3) compliant.
 2. See <https://www.diodes.com/quality/lead-free/> for more information about Diodes Incorporated's definitions of Halogen- and Antimony-free, "Green" and Lead-free.
 3. Halogen- and Antimony-free "Green" products are defined as those which contain <900ppm bromine, <900ppm chlorine (<1500ppm total Br + Cl) and <1000ppm antimony compounds.
 4. For packaging details, go to our website at <https://www.diodes.com/design/support/packaging/diodes-packaging/>.

Pin Description

Pin Number	Pin Name	Pin Function
1, 9	V_{IN}	Drain of MOSFET (0.5V to 13.5V), Pin 1 must be connected to Pin 9
2	EN	Active-high digital input used to turn on the MOSFET, pin has an internal pull down resistor to GND
3	V_{CC}	Supply voltage to controller (3.0V to 5.5V)
4	GND	Controller ground
5	BLEED	Load bleed connection, must be tied to V_{OUT} through a resistor $\leq 1k\Omega$
6	PG	Active-high, open-drain output that indicates when the gate of the MOSFET is fully charged, external pull up resistor $\geq 1k\Omega$ to an external voltage source required; tie to GND if not used.
7, 8	V_{OUT}	Source of MOSFET connected to load

Marking Information

V-DFN2020-8 (Type F)

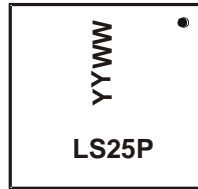

LS25P = Product Type Marking Code
YYWW = Date Code Marking
YY = Last Two Digits of Year (ex: 18 = 2018)
WW = Week Code (01 to 53)

Functional Block Diagram

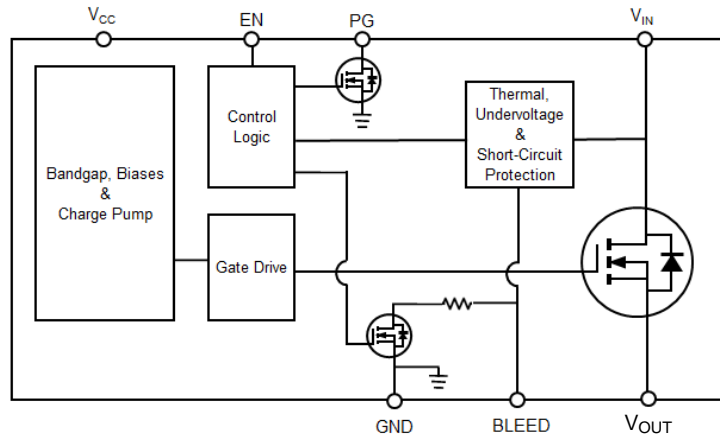

Application Circuit

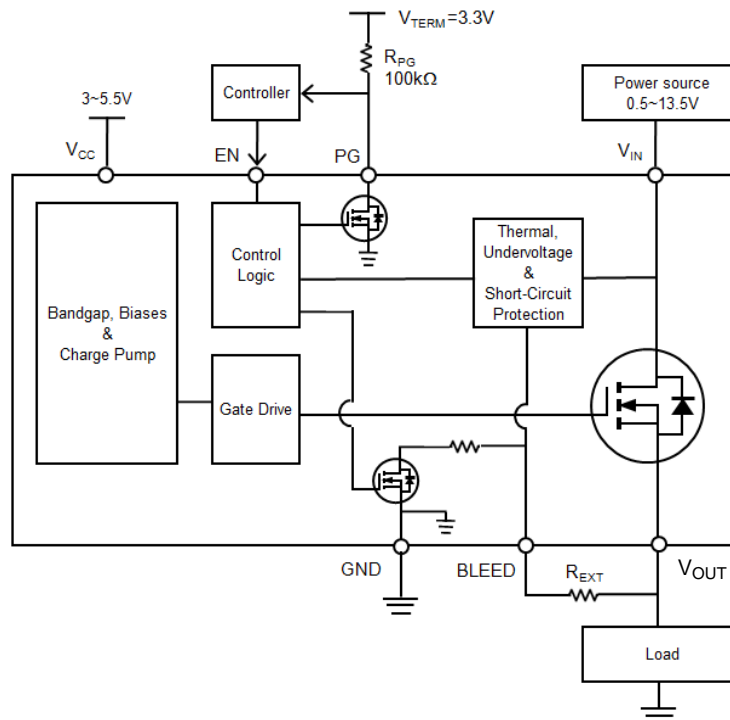

NEW PRODUCT

Absolute Maximum Ratings

Parameter	Rating
V _{IN} , BLEED, V _{OUT} to GND	-0.3V to 18V
EN, V _{CC} , PG to GND	-0.3V to 6V
I _{MAX}	10.5A
Junction Temperature (T _J)	+150°C
Storage Temperature (T _S)	-65°C to +150°C

Recommended Operating Ratings

Parameter	Rating
Supply Voltage (V _{CC})	3V to 5.5V
Input Voltage (V _{IN})	0.5V to 13.5V
Ambient Temperature (T _A)	-40°C to +85°C
Package Thermal Resistance (θ _{JC})	5.3°C/W
Package Thermal Resistance (θ _{JA})	40°C/W

Electrical Characteristics (T_J = +25°C, unless otherwise specified.)

Symbol	Parameter	Conditions	Min	Typ	Max	Unit
V _{IN}	Input Voltage	—	0.5	—	13.5	V
V _{CC}	Supply Voltage	—	3.0	—	5.5	V
I _{DYN}	V _{CC} Dynamic Supply Current	V _{EN} = V _{CC} = 3V, V _{IN} = 12V	—	310	400	μA
		V _{EN} = V _{CC} = 5.5V, V _{IN} = 1.8V	—	510	750	μA
I _{STBY}	V _{CC} Shutdown Supply Current	V _{CC} = 3V, V _{EN} = 0V	—	0.1	1	μA
		V _{CC} = 5.5V, V _{EN} = 0V	—	0.1	2	μA
V _{ENH}	EN High Level Voltage	V _{CC} = 3V to 5.5V	2.0	—	—	V
V _{ENL}	EN Low Level Voltage	V _{CC} = 3V to 5.5V	—	—	0.8	V
R _{BLEED}	Bleed Resistance	V _{CC} = 3V, V _{EN} = 0V	86	108	130	Ω
		V _{CC} = 5.5V, V _{EN} = 0V	64	80	100	Ω
I _{BLEED}	Bleed Pin Leakage Current	V _{CC} = V _{EN} = 3V, V _{IN} = 1.8V	—	20	45	μA
		V _{CC} = V _{EN} = 3V, V _{IN} = 12V	—	50	70	μA
V _{PGL}	PG Output Low Voltage	V _{CC} = 3V; I _{SINK} = 5mA	—	—	0.2	V
I _{PG}	PG Output Leakage Current	V _{CC} = 3V; V _{TERM} = 3.3V	—	—	100	nA
Switching Device						
R _{ON}	Switch On-State Resistance	V _{CC} = 3.3V, V _{IN} = 1.8V	—	10.8	12.5	mΩ
		V _{CC} = 3.3V, V _{IN} = 5V	—	10.8	12.5	mΩ
		V _{CC} = 3.3V, V _{IN} = 12V	—	10.8	12.5	mΩ
		V _{CC} = 5V, V _{IN} = 1.8V	—	8.6	10.5	mΩ
		V _{CC} = 5V, V _{IN} = 5V	—	8.6	10.5	mΩ
		V _{CC} = 5V, V _{IN} = 12V	—	8.6	10.5	mΩ
I _{LEAK}	Input Shutdown Supply Current	V _{EN} = 0V, V _{IN} = 13.5V	—	—	1	μA
R _{PDEN}	EN Pull Down Resistance	—	76	100	124	kΩ
Fault Protection						
OTP	Thermal Shutdown Threshold	V _{CC} = 3V to 5.5V	—	145	—	°C
OTPHYS	Thermal Shutdown Hysteresis	V _{CC} = 3V to 5.5V	—	20	—	°C
UVLO	V _{IN} Lockout Threshold	V _{CC} = 3V	0.25	0.35	0.45	V
UVLOHYS	V _{IN} Lockout Hysteresis	V _{CC} = 3V	20	40	70	mV
SCP	Short-Circuit Protection Threshold	V _{CC} = 3.3V; V _{IN} = 0.5V	180	265	350	mV
		V _{CC} = 3.3V; V _{IN} = 13.5V	100	285	500	mV

Switching Characteristics ($T_J = +25^\circ\text{C}$, $V_{\text{TERM}} = V_{\text{CC}}$; $R_{\text{PG}} = 100\text{k}\Omega$; $R_L = 10\Omega$; $C_L = 0.1\mu\text{F}$, unless otherwise specified).

Symbol	Parameter	Condition	Min	Typ	Max	Unit
$V_{\text{IN}} = 1.8\text{V}$						
t_{ON}	Output Turn-On Delay time	$V_{\text{CC}}=3.3\text{V}$	—	200	—	μs
		$V_{\text{CC}}=5\text{V}$	—	190	—	
t_{OFF}	Output Turn-Off Delay time	$V_{\text{CC}}=3.3\text{V}$	—	0.4	—	μs
		$V_{\text{CC}}=5\text{V}$	—	0.4	—	
t_{PGON}	Power Good Turn-on Time	$V_{\text{CC}}=3.3\text{V}$	—	1.25	—	ms
		$V_{\text{CC}}=5\text{V}$	—	1.05	—	
t_{PGOFF}	Power Good Turn-off Time	$V_{\text{CC}}=3.3\text{V}$	—	10	—	ns
		$V_{\text{CC}}=5\text{V}$	—	8	—	
SR	Output Slew Rate	$V_{\text{CC}}=3.3\text{V}$	—	23	—	kV/s
		$V_{\text{CC}}=5\text{V}$	—	24	—	
$V_{\text{IN}} = 12\text{V}$						
t_{ON}	Output Turn-On Delay time	$V_{\text{CC}}=3.3\text{V}$	—	190	—	μs
		$V_{\text{CC}}=5\text{V}$	—	180	—	
t_{OFF}	Output Turn-Off Delay time	$V_{\text{CC}}=3.3\text{V}$	—	0.4	—	μs
		$V_{\text{CC}}=5\text{V}$	—	0.4	—	
t_{PGON}	Power Good Turn-on Time	$V_{\text{CC}}=3.3\text{V}$	—	1.3	—	ms
		$V_{\text{CC}}=5\text{V}$	—	1.25	—	
t_{PGOFF}	Power Good Turn-off Time	$V_{\text{CC}}=3.3\text{V}$	—	10	—	ns
		$V_{\text{CC}}=5\text{V}$	—	8	—	
SR	Output Slew Rate	$V_{\text{CC}}=3.3\text{V}$	—	80	—	kV/s
		$V_{\text{CC}}=5\text{V}$	—	81	—	

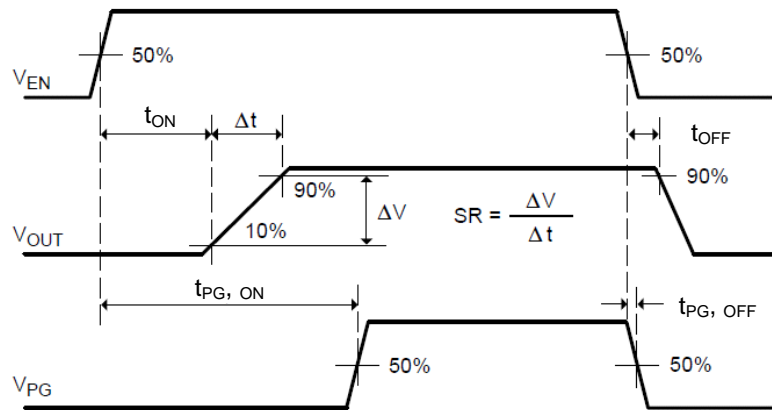
Figure 1 Timing Diagram
NEW PRODUCT

Performance Characteristics (@T_A = +25°C, unless otherwise specified.)

NEW PRODUCT

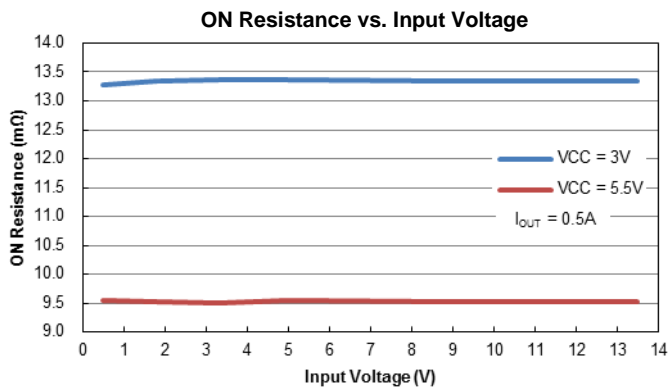
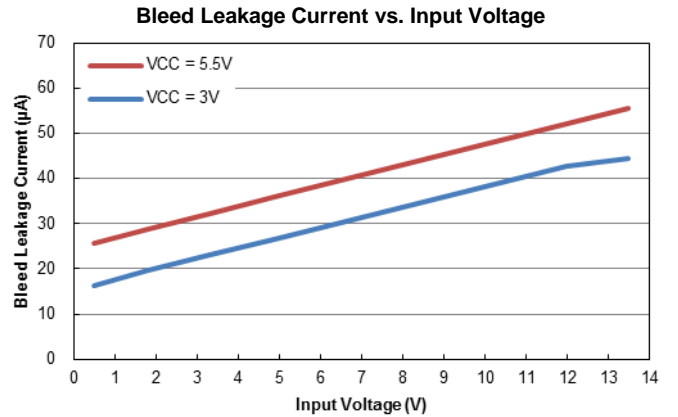
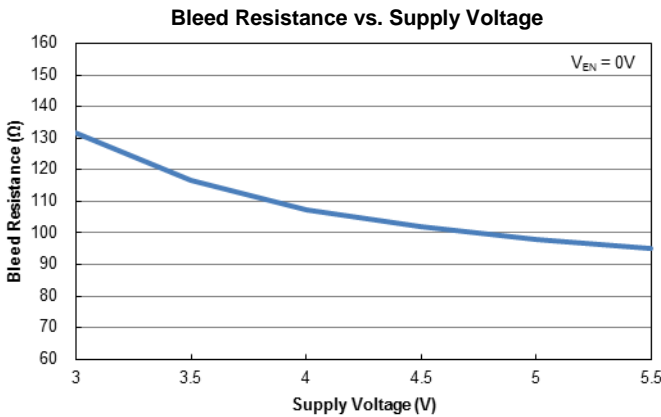
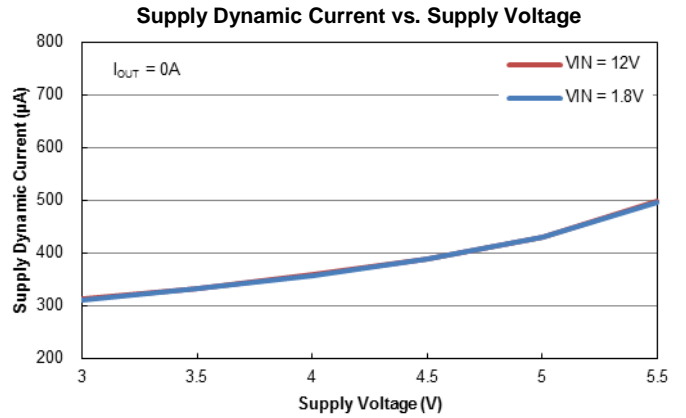
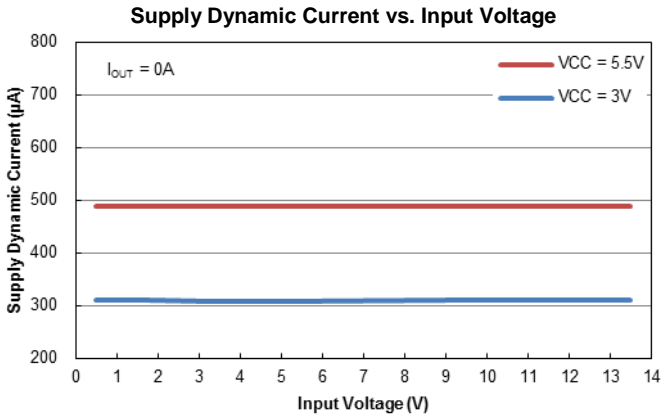

Performance Characteristics (@ $T_A = +25^\circ\text{C}$, unless otherwise specified. Cont.)

NEW PRODUCT

Turn ON Response

$V_{IN} = 1.8\text{V}$, $V_{CC} = 3.3\text{V}$, $V_{EN} = 0\text{V to } 3.3\text{V}$, $R_L = 10\Omega$

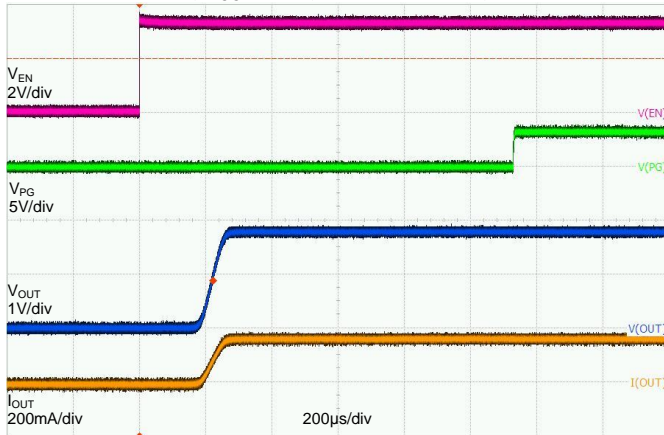

Turn OFF Response

$V_{IN} = 1.8\text{V}$, $V_{CC} = 3.3\text{V}$, $V_{EN} = 3.3\text{V to } 0\text{V}$, $R_L = 10\Omega$

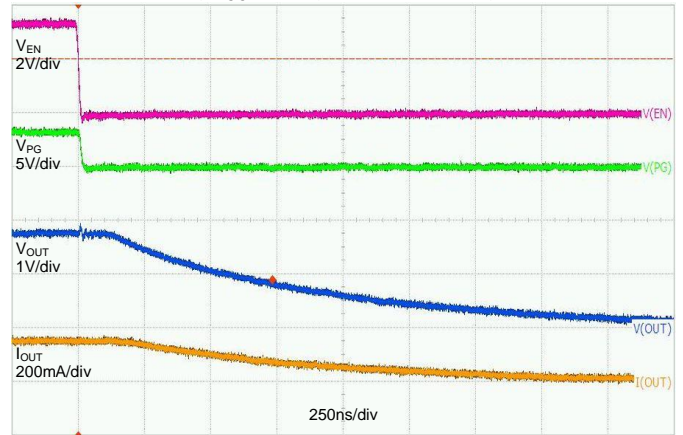

Turn ON Response

$V_{IN} = 5.0\text{V}$, $V_{CC} = 3.3\text{V}$, $V_{EN} = 0\text{V to } 3.3\text{V}$, $R_L = 10\Omega$

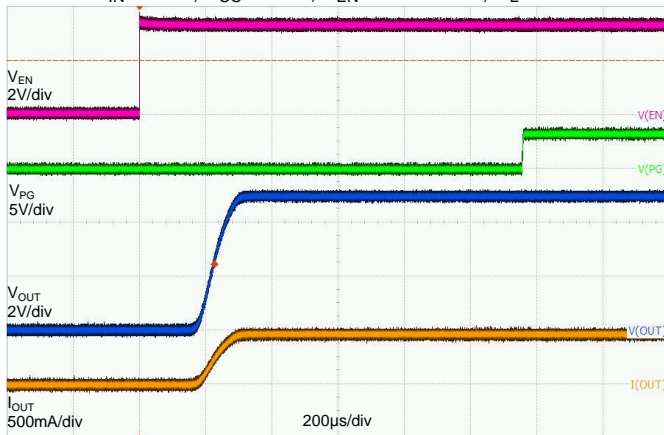

Turn OFF Response

$V_{IN} = 5.0\text{V}$, $V_{CC} = 3.3\text{V}$, $V_{EN} = 3.3\text{V to } 0\text{V}$, $R_L = 10\Omega$

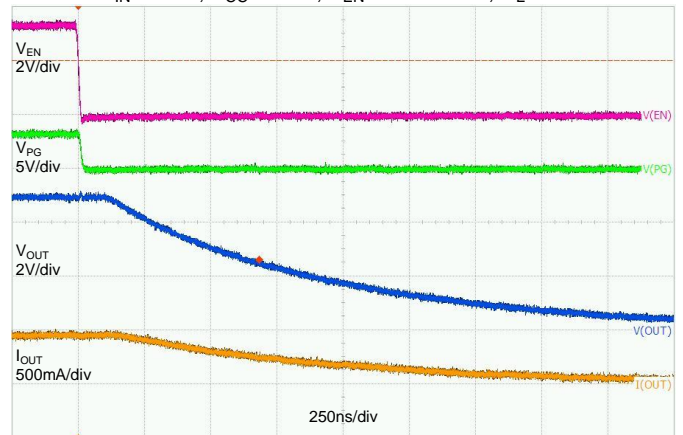

Turn ON Response

$V_{IN} = 12\text{V}$, $V_{CC} = 3.3\text{V}$, $V_{EN} = 0\text{V to } 3.3\text{V}$, $R_L = 10\Omega$

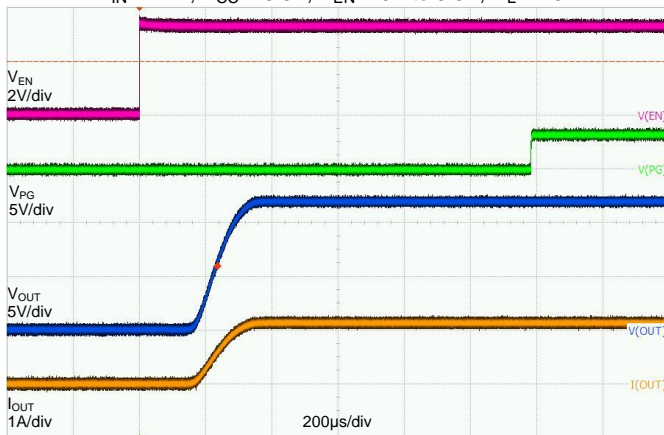

Turn OFF Response

$V_{IN} = 12\text{V}$, $V_{CC} = 3.3\text{V}$, $V_{EN} = 3.3\text{V to } 0\text{V}$, $R_L = 10\Omega$

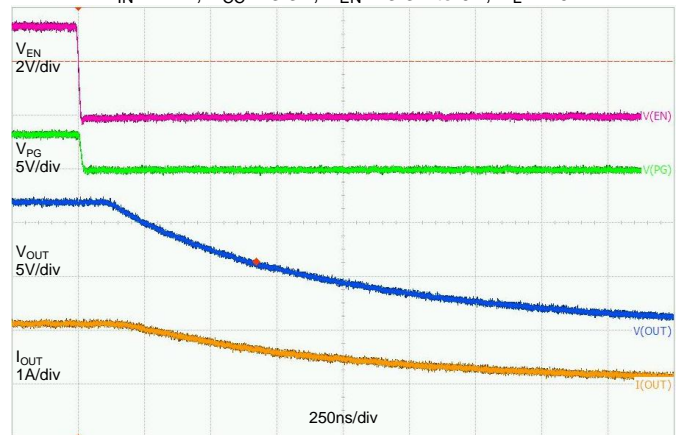

Performance Characteristics (@ $T_A = +25^\circ\text{C}$, unless otherwise specified. Cont.)

NEW PRODUCT

Turn ON Response

$V_{IN} = 1.8\text{V}$, $V_{CC} = 5.0\text{V}$, $V_{EN} = 0\text{V to } 3.3\text{V}$, $R_L = 10\Omega$

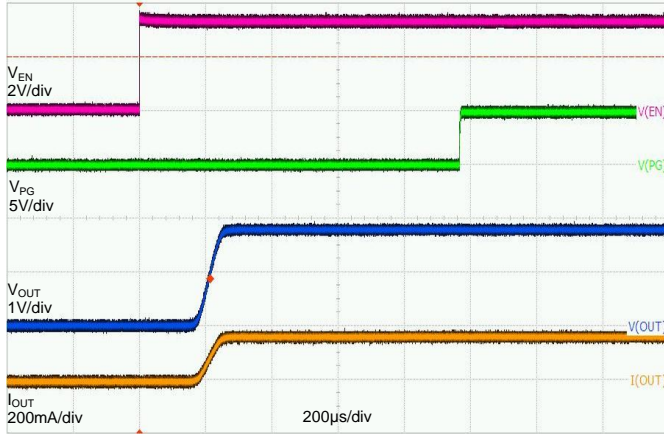

Turn OFF Response

$V_{IN} = 1.8\text{V}$, $V_{CC} = 5.0\text{V}$, $V_{EN} = 3.3\text{V to } 0\text{V}$, $R_L = 10\Omega$

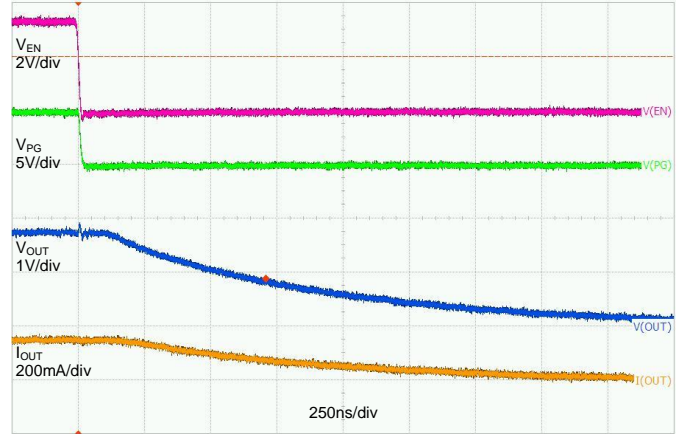

Turn ON Response

$V_{IN} = 5.0\text{V}$, $V_{CC} = 5.0\text{V}$, $V_{EN} = 0\text{V to } 3.3\text{V}$, $R_L = 10\Omega$

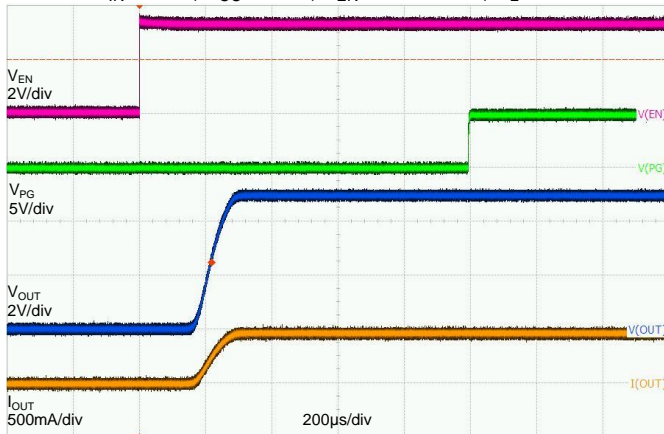

Turn OFF Response

$V_{IN} = 5.0\text{V}$, $V_{CC} = 5.0\text{V}$, $V_{EN} = 3.3\text{V to } 0\text{V}$, $R_L = 10\Omega$

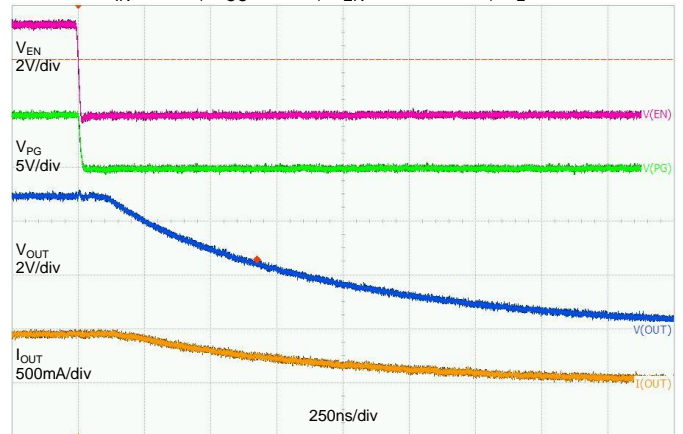

Turn ON Response

$V_{IN} = 12\text{V}$, $V_{CC} = 5.0\text{V}$, $V_{EN} = 0\text{V to } 3.3\text{V}$, $R_L = 10\Omega$

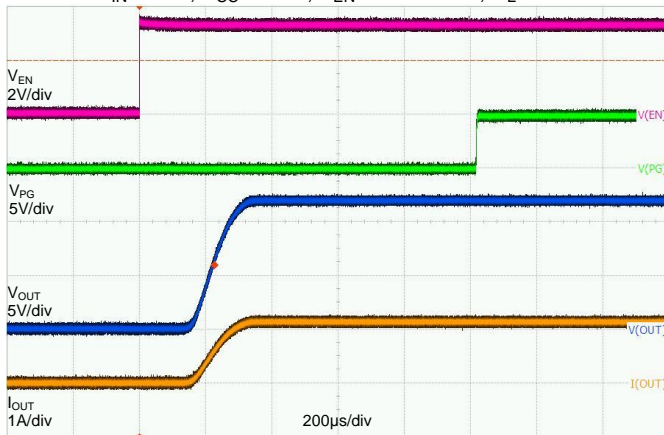

Turn OFF Response

$V_{IN} = 12\text{V}$, $V_{CC} = 5.0\text{V}$, $V_{EN} = 3.3\text{V to } 0\text{V}$, $R_L = 10\Omega$

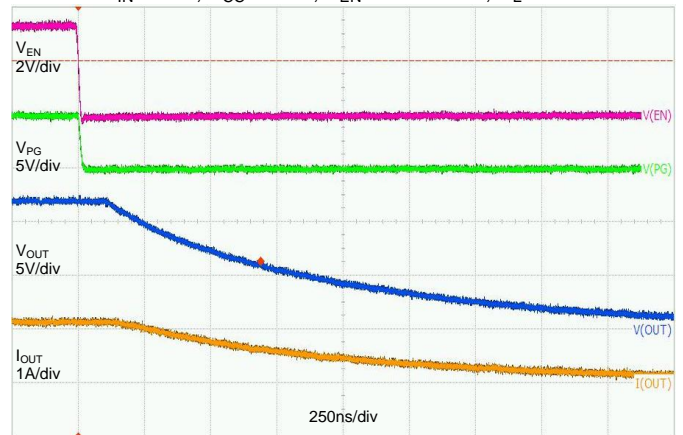

Package Outline Dimensions

Please see <http://www.diodes.com/package-outlines.html> for the latest version.

V-DFN2020-8 (Type F)

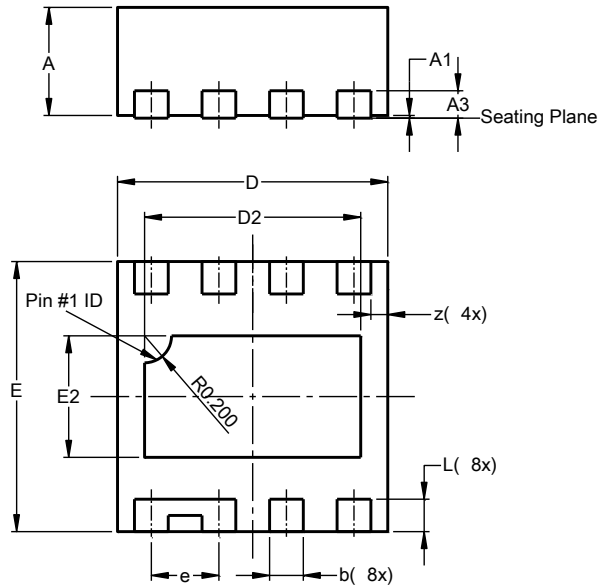

V-DFN2020-8 (Type F)			
Dim	Min	Max	Typ
A	0.77	0.85	0.80
A1	0.00	0.05	0.02
A3	--	--	0.203
b	0.20	0.30	0.25
D	1.95	2.05	2.00
D2	1.50	1.70	1.60
E	1.95	2.05	2.00
E2	0.80	1.00	0.90
e	--	--	0.50
L	0.19	0.29	0.24
z	--	--	0.125
All Dimensions in mm			

NEW PRODUCT

Suggested Pad Layout

Please see <http://www.diodes.com/package-outlines.html> for the latest version.

V-DFN2020-8 (Type F)

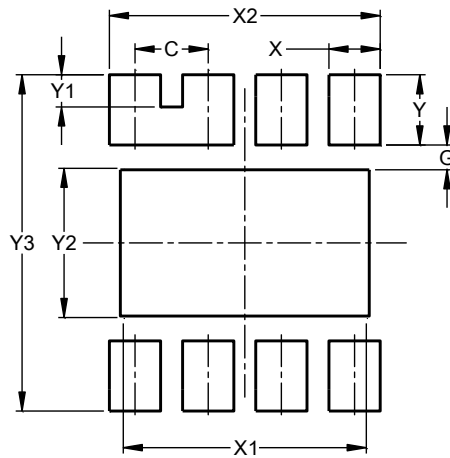

Dimensions	Value (in mm)
C	0.500
G	0.170
X	0.350
X1	1.660
X2	1.850
Y	0.480
Y1	0.220
Y2	1.020
Y3	2.300

IMPORTANT NOTICE

DIODES INCORPORATED MAKES NO WARRANTY OF ANY KIND, EXPRESS OR IMPLIED, WITH REGARDS TO THIS DOCUMENT, INCLUDING, BUT NOT LIMITED TO, THE IMPLIED WARRANTIES OF MERCHANTABILITY AND FITNESS FOR A PARTICULAR PURPOSE (AND THEIR EQUIVALENTS UNDER THE LAWS OF ANY JURISDICTION).

Diodes Incorporated and its subsidiaries reserve the right to make modifications, enhancements, improvements, corrections or other changes without further notice to this document and any product described herein. Diodes Incorporated does not assume any liability arising out of the application or use of this document or any product described herein; neither does Diodes Incorporated convey any license under its patent or trademark rights, nor the rights of others. Any Customer or user of this document or products described herein in such applications shall assume all risks of such use and will agree to hold Diodes Incorporated and all the companies whose products are represented on Diodes Incorporated website, harmless against all damages.

Diodes Incorporated does not warrant or accept any liability whatsoever in respect of any products purchased through unauthorized sales channel. Should Customers purchase or use Diodes Incorporated products for any unintended or unauthorized application, Customers shall indemnify and hold Diodes Incorporated and its representatives harmless against all claims, damages, expenses, and attorney fees arising out of, directly or indirectly, any claim of personal injury or death associated with such unintended or unauthorized application.

Products described herein may be covered by one or more United States, international or foreign patents pending. Product names and markings noted herein may also be covered by one or more United States, international or foreign trademarks.

This document is written in English but may be translated into multiple languages for reference. Only the English version of this document is the final and determinative format released by Diodes Incorporated.

LIFE SUPPORT

Diodes Incorporated products are specifically not authorized for use as critical components in life support devices or systems without the express written approval of the Chief Executive Officer of Diodes Incorporated. As used herein:

A. Life support devices or systems are devices or systems which:

1. are intended to implant into the body, or
2. support or sustain life and whose failure to perform when properly used in accordance with instructions for use provided in the labeling can be reasonably expected to result in significant injury to the user.

B. A critical component is any component in a life support device or system whose failure to perform can be reasonably expected to cause the failure of the life support device or to affect its safety or effectiveness.

Customers represent that they have all necessary expertise in the safety and regulatory ramifications of their life support devices or systems, and acknowledge and agree that they are solely responsible for all legal, regulatory and safety-related requirements concerning their products and any use of Diodes Incorporated products in such safety-critical, life support devices or systems, notwithstanding any devices- or systems-related information or support that may be provided by Diodes Incorporated. Further, Customers must fully indemnify Diodes Incorporated and its representatives against any damages arising out of the use of Diodes Incorporated products in such safety-critical, life support devices or systems.

Copyright © 2018, Diodes Incorporated

www.diodes.com

Компания «Life Electronics» занимается поставками электронных компонентов импортного и отечественного производства от производителей и со складов крупных дистрибьюторов Европы, Америки и Азии.

С конца 2013 года компания активно расширяет линейку поставок компонентов по направлению коаксиальный кабель, кварцевые генераторы и конденсаторы (керамические, пленочные, электролитические), за счёт заключения дистрибьюторских договоров

Мы предлагаем:

- Конкурентоспособные цены и скидки постоянным клиентам.
- Специальные условия для постоянных клиентов.
- Подбор аналогов.
- Поставку компонентов в любых объемах, удовлетворяющих вашим потребностям.
- Приемлемые сроки поставки, возможна ускоренная поставка.
- Доставку товара в любую точку России и стран СНГ.
- Комплексную поставку.
- Работу по проектам и поставку образцов.
- Формирование склада под заказчика.
- Сертификаты соответствия на поставляемую продукцию (по желанию клиента).
- Тестирование поставляемой продукции.
- Поставку компонентов, требующих военную и космическую приемку.
- Входной контроль качества.
- Наличие сертификата ISO.

В составе нашей компании организован Конструкторский отдел, призванный помогать разработчикам, и инженерам.

Конструкторский отдел помогает осуществить:

- Регистрацию проекта у производителя компонентов.
- Техническую поддержку проекта.
- Защиту от снятия компонента с производства.
- Оценку стоимости проекта по компонентам.
- Изготовление тестовой платы монтаж и пусконаладочные работы.



Тел: +7 (812) 336 43 04 (многоканальный)
Email: org@lifeelectronics.ru