

Description	Page Number(s)
Portable Labeling Systems and Printers	5-26
Pan-Quik™ LS3E Hand-Held Dot-Matrix Printer	6-11
LS5 and LS5E Industrial Labeling Systems	12-14
LS4H Heat Shrink / Laminated Tape Labeling System	15
LS4M Multiple Line Portable Labeling System	16
PTR1 Flat-Bed Dot-Matrix Printer	17-19
DURA-MARK™ PTR2 Thermal Transfer Printer	20-25
PTR3 Thermal Transfer Printer	26
 Software	 27-32
PAN-MARK™ for WINDOWS^	28
PAN-MARK LT for DOS	29
PROG-LITE Software for PTR1 Printer	30
SAFETY EASE™ Marker and Tag Software.....	31-32
 Thermal Transfer Labels	 33-47
Suggested Applications	34-35
Material Selection Guide	36
Label Listing by Material	36-39
Network Systems Labels.....	40-41
Label Drawings - Labels Listed by Size.....	42-44
Heat Shrink Labels for Thermal Transfer	45
Thermal Transfer Ribbons	46-47
 Ink Jet Labels	 49-56
Suggested Applications	50-50
Material Selection Guide	51
Label Listing by Material	51-52
Network Systems Labels.....	53
Label Drawings - Labels Listed by Size.....	55-56
Smear Resistant Ink Jet Cartridges and Refills	54
 Laser Printable Labels	 57-77
Suggested Applications	58-59
Material Selection Guide	60
Label Listing by Material	60-66
Network Systems Labels.....	67-69
Label Drawings - Labels Listed by Size.....	70-77
 Dot-Matrix Labeling Products	 79-130
Dot-Matrix Labels	80-121
Suggested Applications	81-83
Material Selection Guide	84
Self-Laminating Label Listing by Material	85-87
Blank Label Listing by Material	88-96
Network Systems Labels.....	97-100
Machinery Materials Identification Labels	101
Typewriter Sheets	102
Paper Labels.....	103-105
Self-Laminating Label Drawings - Labels Listed by Size	106-111
Blank Label Drawings - Labels Listed by Size	112-121

Table of Contents

Description	Page Number(s)
Dot-Matrix Heat Shrink Label Kits	122
Heat Shrink Tools and Accessories	123
Dot-Matrix Data Plates	124-125
Suggested Applications	124
Material Selection Guide	125
Label Drawings - Labels Listed by Size	125
Dot-Matrix Indelible Ink Ribbons	126-128
Suggested Applications	126
Ribbons by Printer Model.....	127-128
Marker Ties and Marker Plates.....	129-130
Wire Marking Products.....	132-150
Marker Books	132-137
Marker Cards	138-147
Wire Marker Tape Dispenser and Rolls	148
Slip-On Wire Markers	149
Clip-On Wire Markers.....	150
Cable Marking Products.....	151-155
Self-Laminating Cable Marker Holders	152
Clear Heat Shrink Tubing for Protected Wire and Cable Marking.....	153
Fiber Optic Cable Tags and Markers	154
Underground Hazard Tape.....	155
Electrical, Voltage and Fiber Optic Markers	157-160
Voltage and Fiber Optic Markers	157-158
Voltage and Ampere Markers	159
Electrical Symbols	160
Warning Labels	161-167
Static Awareness Labels	162
Electrical Hazard Labels	163-164
Packaging / Shipping Labels.....	165
ISO Labels.....	166-167
Quality Assurance, Inspection and Industrial Labels	169-180
Calibration Labels	170-171
Quality Assurance Labels and Tags.....	172-175
Inspection Labels and Tags	176-178
Production Control Tags.....	179-180
Reference Pages	181-204
Computer Printable Labels by Size	181-195
Wire Size Selection Guide	196
Alpha-Numeric Part Number Index.....	197-204

Meet your on-site labeling needs *FAST* with the *Pan-Quik*[™] LS3E Hand-Held Printer from Panduit

With 20 Kb Memory to Save, Recall and Edit Label Files

Fast

Affordable

Easy to Use

Versatile

Other Features

- Flexibility to print self-laminating wire markers, heat shrink markers, component labels, asset identification labels and more
- Fast drying self-laminating labels reduce installation time
- Automatic recall of last legend entered
- Easy formatting options reduce set-up time
- Automatic serialization and legend repeat functions
- Quick change battery pack and optional AC adapter for reduced downtime
- More than 25 font styles and sizes
- Exact label registration

See [pages 6-11](#) for complete information

Printer Selection Matrix

	Printers						
Features	LS3E (Pg. 6)	LS5/LS5E (Pg. 12)	LS4H (Pg. 15)	LS4M (Pg. 16)	PTR1 (Pg. 17)	PTR2 (Pg. 20)	PTR3 (Pg. 26)

Label Options

Self-Laminating Wire Markers	Yes	Yes	No	No	Yes	Yes	Yes
Solid Wire Markers	Yes	Yes	No	No	Yes	Yes	Yes
Heat Shrink Markers	Yes	Yes	Yes	No	Yes	Yes	Yes
Component Markers	Yes	Yes	No	No	Yes	Yes	Yes
Terminal Block Markers	Yes	No	No	No	Yes	No	No
Industrial Laminated Tape	No	Yes	Yes	Yes	No	No	No
Commercial Non-Laminated Tape	No	Yes	No	Yes	No	Yes	Yes

Mechanical Specifications

Type	Hand-Held	Hand-Held	Portable	Portable	Desktop	Desktop	Desktop
Print Method	9-Pin Dot-Matrix	Thermal Transfer	Thermal Transfer	Thermal Transfer	24-Pin Dot-Matrix	Thermal Transfer	Thermal Transfer
Volume	Low	Low	Low	Low	Medium to High	Medium to High	High
Label Widths	0.25" - 1.50" (6.4 - 38.1 mm)	0.50" - 1.00" (12.7 - 25.4 mm)	0.50" (12.7 mm)	0.50" (12.7 mm)	Up to 8.50" (215.9 mm)	Up to 4.10" (104.1 mm)	Up to 5.00" (127.0 mm)
Weight	2.7 lbs. (1.2 kg)	4.7 lbs. (2.1 kg)	3.5 lbs. (1.6 kg)	3.5 lbs. (1.6 kg)	10 lbs. (4.5 kg)	4 lbs. (1.8 kg)	40 lbs. (18 kg)
Power Supply	Battery Pack or AC	Batteries or AC	Batteries or AC	Batteries or AC	AC	AC	AC
PC Interface Required	No	No	No	No	Yes	Yes	Yes
Optical Registration for Exact Print Registration	Yes	Yes	N/A	N/A	N/A	Yes	Yes
Memory	20 Kb	LS5 - 16Kb, LS5E - 450Kb	No	No	N/A	N/A	N/A
RS232 Port	No	Yes	No	No	Computer Interface	Computer Interface	Computer Interface
Cutter	No	Yes	Yes	Yes	No	No	No

Print Options

Print Sizes	Small, Compressed, Normal, Large	6 point to 72 point	8 point to 16 point	6 point to 24 point	All WINDOWS* fonts	0.06" - 3.50" (1.5 - 88.9 mm)	0.06" - 4.10" (1.5 - 104.1 mm)
Lines of Variable Print	47	6	1	4	Dependent on software	Dependent on software	Dependent on software
Upper and Lower Case	Yes	Yes	Yes	Yes	Yes	Yes	Yes
Underline / Rotated / Bold Text	Yes	Yes	Yes	Yes	Yes	Yes	Yes
Serialization	Yes	Yes	Yes	Yes	Yes	Yes	Yes
Bar Codes	No	Yes	No	Yes (with optional font card)	Yes	Yes	Yes
Special Print Modes	Wire Marker, Center, Strip, Terminal	None	None	None	Yes (with software)	Yes	Yes

PANDUIT® Portable Labeling Systems and Printers

Select the system that suits your labeling application:



Pan-Quik™ LS3E Hand-Held Dot-Matrix Printer **Pages 6 - 11**

- Lightweight, versatile printer for high quality labels that you can print anytime, anywhere
- Prints wire markers, heat shrink markers, component labels and network labels faster than other hand-held, dot-matrix printers
- Features the **Quik-Key™** Fast Label Formatting System



LS5 and LS5E Industrial Labeling Systems **Pages 12 - 14**

- Hand-held, thermal transfer labeling system designed to meet the rugged demands of industrial labeling applications
- Prints self-laminating markers, die-cut labels, heat shrink markers, tamper evident tape, laminated tape and non-laminated tape
- Alpha and numeric sequencing and bar code capabilities



LS4H Heat Shrink / Laminated Tape Labeling System **Page 15**

- High performance, self-contained thermal transfer labeling system that produces high quality, permanent tube markers and scratch resistant laminated polyester component markers
- Compact, portable size allows usage anywhere



LS4M Multiple Line Portable Labeling System **Page 16**

- High performance, self-contained labeling system that prints up to four lines of text on 0.50" (12.7 mm) wide adhesive tape
- Provides durable, high quality, permanent labels



PTR1 Flat-Bed, Dot-Matrix Printer **Pages 17 - 19**

- Produces **ON-DEMAND™** Wire Marker Cards, Self-Laminating Wire Markers, Heat Shrink Labels — any pin-fed label!
- Straight label path eliminates the potential for jamming
- Adjustable print head gap eliminates smearing, especially on thick material such as heat shrink



DURA-MARK™ PTR2 Thermal Transfer Printer **Pages 20 - 25**

- High quality, thermal transfer printer for medium to high volume printing applications
- Create your own custom wire markers, heat shrink markers, bin markers and large labels with characters up to 3.5" (89 mm) high
- Flexibility at your fingertips!



PTR3 Thermal Transfer Printer **Page 26**

- Fast, rugged, thermal transfer printer for high volume printing applications
- Prints crisp, quality 203 dpi resolution images at speeds up to 10 inches per second
- 16 bar code symbologies plus 12 fonts are built in for making labels with minimum programming and fast data transfer

Pan-Quik™ LS3E Hand-Held Dot-Matrix Printer Features



Finally, there's a fast, reliable hand-held printer that creates crisp, clear legends in a variety of sizes, is simple to use, easy to load and offers long battery life. All at an affordable price!

The **Pan-Quik** LS3E printer lets you quickly create custom or serialized labels, wire markers, heat shrink markers, component labels, and network labels, all for greater time savings and convenience. You can save and retrieve files so its easy to produce labels with frequently used formats and legends. Labels are available with widths from 0.25" to 1.50" (6.4 mm to 38.1 mm) in a variety of materials. It's the versatile, easy way to identify wires, cables, modular jacks, faceplates, terminal blocks and patch panels.

It's perfect for on-site project locations and quick maintenance applications.

Printing That Outperforms The Competition

Features	Benefits
Instant Labels	Prints custom labels in a matter of seconds.
Print Head Travels Only as Far as Legend Requires	Labels with shorter legends print even faster!
Express Formatting Option to Set all Print Characteristics at One Time	Eliminate formatting set-up time for frequently used label formats such as wire marking, component identification and patch panel labeling.
Quik-Key™ Fast Label Formatting System	Fast set-up for: text font, size, case and position; print density and label format.
Automatic Recall of Last Label Entered	No need to reenter information after shut-off or recharging battery pack.
Save and Retrieve Files	Save time when printing frequently used labels.
Multi-Language Screen Prompts	Choose from English, German, French, Italian, Dutch, Spanish and Portuguese language screen prompts as needed.
Letter Quality Font	Produce top-quality labels with clear, crisp legends.
Rotated Text	Run type horizontal or rotated, whichever best meets your need.
Underlined Text	Separates headings or emphasizes words.
Small Text Size	More lines per lineal inch.
Automatic Serialization of Labels	Serialize in Numeric or Alphabetic sequence. Saves time when printing a series of labels.
Automatic Repeat of Legend	Able to print wire markers quickly and efficiently. Saves time when printing duplicate labels.
Portable / Battery-Operated	Able to go anywhere. Can go on-site easily to every job. No AC power required.
Long Battery Life	Increased efficiency with more labels produced between battery charges.
Easy Loading	Less downtime for changeover.
9-Pin Dot-Matrix Print Head	Printed legends are easy to read. More pins for faster speed and better print quality.
Optical Sensor	Provides perfect label registration; minimizes set-up time and wasted labels.
Lightweight	Less operator fatigue. Easy to handle and use.
AC Adapters Available	Print more labels without having to recharge battery.
On-Demand Printing	Just-in-time labels. Creates the label you want, when you want it.
Versatile	One printer to print labels, vinyl cloth wire markers, self-laminating wire markers, heat shrink wire markers, component labels, and data communication labels.
Custom Markers at Lower Cost	Reduces inventory carrying costs.
Easy to Use / User Friendly	No special training required. Anyone can make labels.

Pan-Quik™ LS3E Hand-Held Dot-Matrix Printer and Accessories



Printer Mechanical Information

Print Method: 9 pin dot-matrix print head

Size: Height: 3.6" (91.9 mm)
 Width: 4.2" (108.0 mm)
 Length: 13.2" (336.6 mm)
 Weight: 2.7 lbs. (1.2 kg)

Display: Two-line x 16 character liquid crystal display

Keyboard: 49 color coded keys with ergonomically designed keypad

Power Source: 12 VDC, 1200 mAh rechargeable Ni-Cad Battery Pack (Included)

Printer

Part Number	Description	Plug Type	Manual Language	Std. Pkg. Qty.*
LS3E†	Includes Printer, Battery Pack, Battery Charger, Printer Ribbon, Wrist Strap and Operator's Manual	North American 120	English	1
LS3E-PS			Portuguese	
LS3E-ES			Spanish	
LS3E-KIT	Includes all components of LS3E printer shown above plus LS3EAK-S AC Adapter and Carrying Case	North American 120	English	1

†Also available with Euro 230, U.K. 240 and Australian 240 Plugs and Operator's Manuals in Chinese, Dutch, French, German, Italian and Japanese. Contact factory for complete part number information.



Replacement Parts and Optional Accessories

Part Number	Description	Plug Type	Std. Pkg. Qty.*
LS3-RIB	Replacement Printer Ribbon	—	1
LS3E-BP	Replacement Battery Pack	—	1
LS3EC-S	Replacement North American 120V Battery Charger <i>Used only to charge LS3E battery. Cannot be used to power LS3E directly from Power Outlet.</i>	North American 120	1
LS3E-MAN-A†	Replacement Operator's Manual - English	—	1
LS3EACS‡	1 each: Universal AC Adapter (LS3EA), Battery Charging Pack (LS3E-CP) and Power Cord Listed (CORD-*) <i>Power LS3E directly from Power Outlet and charge LS3E Battery Pack at the same time</i>	North American 120	1
LS3EAK-S‡	1 each: Universal AC Adapter (LS3EA) and Power Cord Listed (CORD-*) <i>Power LS3E directly from Power Outlet</i>	North American 120	1
LS3ECAP	1 each: Battery Charging Pack (LS3E-CP) and Auto Plug (LS3EAP) <i>Power LS3E directly from Auto Cigarette Lighter and charge LS3E Battery Pack at the same time</i>	—	1
LS3EAP	Replacement Auto Plug <i>Power LS3E directly from Auto Cigarette Lighter</i>	—	1

†To order Operator's Manual in other languages, replace -A with -C for Chinese, -N for Dutch, -F for French, -D for German, -I for Italian, -J for Japanese, -P for Portuguese, and -E for Spanish

‡Also available with Euro 230, U.K. 240 and Australian 240 Plugs. Contact factory for complete part number information.



LS3-RIB



LS3E-BP



LS3EC-S



LS3E-MAN-A



LS3EACS



LS3EAK-S



LS3ECAP



LS3EAP

*Order number of printers or accessories required in multiples of Std. Pkg. Qty.

PANUIT® Pan-Quik™ LS3E Hand-Held Printer

Optional Accessories (cont.)

Part Number	Description	Plug Type	Std. Pkg. Qty.*
LS3E-CP	Replacement Battery Charging Pack <i>Power LS3E directly from AC Power Source and charge LS3E Battery Pack at the same time (Must be used with Universal AC Adapter and Power Cord - not included)</i>	—	1
LS3EA	Universal AC Adapter	—	1
CORD-S†	Replacement Power Cord	North American 120	1
LS3-CASE	Carrying Case	—	1
LS3-BS	Printer Belt Holster	—	1
PTR-CLN	Printer Cleaning Kit Contains 4 oz. (116 ml) bottle cleaning solution with MSDS, cleaning pen, 100 swabs, 12 alcohol wipes and instructions	—	1



LS3E-CP



LS3EA



CORD-S



LS3-CASE



LS3-BS



PTR-CLN

†Also available with Euro 230, U.K. 240 and Australian 240 Plugs. Contact factory for complete part number information.

*Order number of accessories required in multiples of Std. Pkg. Qty.

Material Selection

Material Type	Temperature Range	Description	Key Feature	Color	Outdoor Rated	Hazardous Environment*	UL Rec.	CSA
SELF-LAMINATING VINYL	-40° to 150°F (-40° to 68°C)	Self-laminating film for most general wire and cable labeling	Low cost, conformable material	Clear	No	No	Yes	Yes
SELF-LAMINATING TEDLAR †	-0° to 275°F (-18° to 135°C)	Self-laminating film for wire and cable labeling in outdoor, high temperature or harsh environments	Resistant to high temperatures and U.V. light	Clear	Yes	Yes	Yes	Yes
VINYL CLOTH	-50° to 170°F (-46° to 77°C)	General purpose material, vinyl impregnated cloth resists oil and abrasion	Material can be removed and reused	White	No	No	No	No
METALLIZED POLYESTER	-40° to 311°F (-40° to 154°C)	Metallized polyester for property and asset marking	Durable material; does not stretch or easily tear	Silver	Yes	Yes	No	No
HEAT SHRINK POLYOLEFIN	-22° to 220°F (-30° to 105°C)	Polyolefin heat shrink for wire marking applications, excellent print quality	Secure identification	White, Yellow	No	No	No	No

†TEDLAR is the registered trademark of E. I. DuPont Co.

*For complete material specification information, contact Product Management at 1-888-506-5400, ext. 7337

The label codes shown in each chart are distinct codes used to tell the printer the size of the label.

NEW! Wire Marker Strips

- Eliminate the carrying costs, shelf-life and inventory concerns of preprinted marker cards
- Marker strips are perforated so they can be used as full size or half size markers in wrap-around or flag style
- Custom firmware for fast and easy on-site wire marking
- Backscore on liner makes strips easy to remove and apply
- Material: White Vinyl Cloth



Part Number	Label Code Half / Full	Width A In. (mm)	Length B In. (mm)	Normal Text		Labels Per Roll	Std. Pkg. Qty.*
				Lines Per Label	Characters Per Line		
L3PCM36	W107 / W207	1.50 (38.1)	0.25 (6.4)	3 / 6	1	500	1 Roll
L3PCM25	W109 / W209	1.50 (38.1)	0.36 (9.1)	3 / 6	2	500	
L3PCM18	W113 / W213	1.50 (38.1)	0.50 (12.7)	3 / 6	4	500	

* Order number of rolls required in multiples of Std. Pkg. Qty.

Note: Based on printer manufacture date, firmware revision may be required to use these labels. Contact factory for upgrade information.

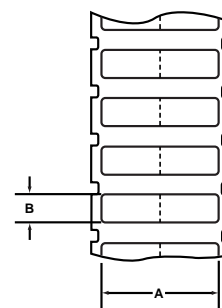

Wire Marker Labels

Self-Laminating Vinyl Wire Markers

- Designed to identify all sizes of wires and cables quickly and economically
- Clear overlamine protects legend
- Part numbers shown have white print-on area
- Multiple across labels available



Part Number	Label Code	Total Area A x B In. (mm)	Print-On Area A x C In. (mm)	Normal Text‡		Outside Cable Diameter Range # In. (mm)	Labels Per Roll	Std. Pkg. Qty.*
				Lines Per Label	Characters Per Line			
Vinyl Material (Indoor Applications)								
LWS-6	1310	0.50 x 0.75 (12.7 x 19.1)	0.50 x 0.38 (12.7 x 9.5)	2	4	0.12 - 0.12 (3.1 - 3.1)	250	1 Roll
LWS-8	2510	0.50 x 0.75 (12.7 x 19.1)	0.50 x 0.38 (12.7 x 9.5)•	2	4		500	
LWS-7	2510	1.00 x 0.75 (25.4 x 19.1)	1.00 x 0.38 (25.4 x 9.5)	2	10		250	
LWS-4	1310	0.50 x 1.00 (12.7 x 25.4)	0.50 x 0.38 (12.7 x 9.5)	2	4	0.12 - 0.20 (3.1 - 5.1)	250	
LWS-5	2510	1.00 x 1.00 (25.4 x 25.4)	1.00 x 0.38 (25.4 x 9.5)	2	10		250	
LWS-1	1313	0.50 x 1.25 (12.7 x 31.8)	0.50 x 0.50 (12.7 x 12.7)	3	4	0.16 - 0.24 (4.1 - 6.1)	250	
LWS-9	2513	0.50 x 1.25 (12.7 x 31.8)	0.50 x 0.50 (12.7 x 12.7)•	3	4		500	
LWS-2†	2513	1.00 x 1.25 (25.4 x 31.8)	1.00 x 0.50 (25.4 x 12.7)	3	10		250	
LWS-3	3813	1.50 x 1.25 (38.1 x 31.8)	1.50 x 0.50 (38.1 x 12.7)	3	16	250		
LWS-10†	2519	1.00 x 2.50 (25.4 x 63.5)	1.00 x 0.75 (25.4 x 19.1)	5	10	0.24 - 0.56 (6.1 - 14.2)	100	
LWS-11	3819	1.50 x 2.50 (38.1 x 63.5)	1.50 x 0.75 (38.1 x 19.1)	5	16		100	
LWS-12†	2525	1.00 x 4.00 (25.4 x 101.6)	1.00 x 1.00 (25.4 x 25.4)	7	10	0.32 - 0.95 (8.1 - 24.1)	100	
LWS-13	3825	1.50 x 4.00 (38.1 x 101.6)	1.50 x 1.00 (38.1 x 25.4)	7	16		100	
LWS-14	2525	1.00 x 6.00 (25.4 x 152.4)	1.00 x 1.00 (25.4 x 25.4)	7	10	0.32 - 1.59 (8.1 - 40.4)	50	
TEDLAR # Material (Indoor /Outdoor Applications)								
LWS-54	2513	1.00 x 1.25 (25.4 x 31.8)	1.00 x 0.50 (25.4 x 12.7)	3	10	0.16 - 0.24 (4.1 - 6.1)	250	1 Roll

‡ Similar information for other text sizes provided in LS3E manual
 † Label available with colored print-on area. Colors may include YL for Yellow, RD for Red, BU for Blue, GR for Green, IG for Gray, OR for orange, PR for Purple and BR for Brown. To order, add appropriate suffix to part number. Contact factory for availability.
 • Denotes butt-cut label, 2 half-wide marker strips
 # TEDLAR is the registered trademark of E. I. DuPont Co.
 * Refer to Wire Size Selection Guide on page 196 to review diameters of commonly used cables
 * Order number of rolls required in multiples of Std. Pkg. Qty.



Standard



Butt-Cut

Wire Marker Labels

- Can be used as wrap-around or flag style markers
- Can also be used for component labeling
- Material: White Vinyl Cloth



Part Number	Label Code	A Width In. (mm)	B Length In. (mm)	Normal Text‡		Labels Per Roll	Std. Pkg. Qty.*
				Lines Per Label	Characters Per Line		
LW-4	1319	0.50 (12.7)	0.75 (19.1)	5	4	250	1 Roll
LW-6	2519	0.50 (12.7)•	0.75 (19.1)	5	4	500	
LW-3	1325	0.50 (12.7)	1.00 (25.4)	7	4	250	
LW-1	1332	0.50 (12.7)	1.25 (31.8)	9	4	250	
LW-5	2532	0.50 (12.7)•	1.25 (31.8)	9	4	500	
LW-2	2532	1.00 (25.4)	1.25 (31.8)	9	10	250	

‡ Similar information for other text sizes provided in LS3E manual
 • Denotes butt-cut label, 2 half-wide marker strips
 * Order number of rolls required in multiples of Std. Pkg. Qty.

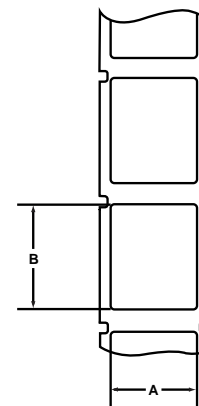

Standard

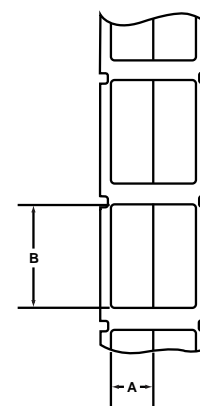

Butt-Cut

Heat Shrink Tubing for Permanent Wire and Cable Identification

- Service Temperature Range: -22°F to 220°F (-30°C to 105°C)
- Shrink Ratio: 3:1 @ 212°F (100°C)
- Flammability: Meets U.L. Standard 224 for flammability
- Material: Flattened Polyolefin
- Use with Panduit Heat Shrink Tools and Accessories shown on [page 25](#)

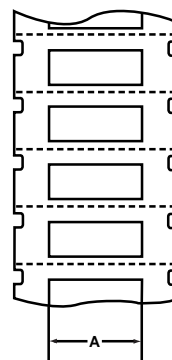
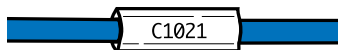

Standard

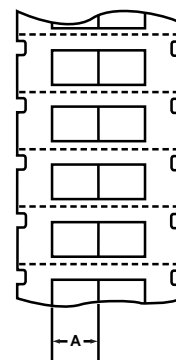

Butt-Cut

Part Number		Label Code	Width A In. (mm)	Markers Per Row	Outside Cable Diameter Range [■] In. (mm)	Normal Text [‡]		Markers Per Roll	Std. Pkg. Qty.*
White	Yellow					Lines Per Label	Characters Per Line		
LHSW-1	LHSY-1	T206	0.50 (12.7) [•]	2	0.04 - 0.13 (1.1 - 3.2)	1	4	1 Roll	
LHSW-2	LHSY-2	T106	1.00 (25.4)	1		0.06 - 0.19 (1.6 - 4.8)	1		
LHSW-6	LHSY-6	T208	0.50 (12.7) [•]	2	0.08 - 0.25 (2.1 - 6.4)		2		
LHSW-7	LHSY-7	T108	1.00 (25.4)	1		0.17 - 0.50 (4.2 - 12.7)	2		
LHSW-3	LHSY-3	T211	0.50 (12.7) [•]	2			2		
LHSW-4	LHSY-4	T111	1.00 (25.4)	1			2		
LHSW-5	LHSY-5	T121	1.00 (25.4)	1			5	10	

[‡] Similar information for other text sizes provided in LS3E manual

[•] Denotes butt-cut label, 2 half-wide marker strips

[■] Refer to Wire Size Selection Guide on [page 196](#) to review diameters of commonly used cables

* Order the number of rolls required in multiples of Std. Pkg. Qty.

Component Labels

- Available in a wide range of sizes
- Material: White Vinyl Cloth

Part Number	Label Code	A Width In. (mm)	B Length In. (mm)	Color	Normal Text [‡]		Labels Per Roll	Std. Pkg. Qty.*
					Lines Per Label	Characters Per Line		
LC-6	1307	0.50 (12.7)	0.28 (7.0)	White	1	4	1 Roll	
LC-3	1313	0.50 (12.7)	0.50 (12.7)	White	3	4		
LC-7	2507	1.00 (25.4)	0.28 (7.0)	White	1	10		
LC-9	2510	1.00 (25.4)	0.40 (10.2)	White	2	10		
LC-10	2513	1.00 (25.4)	0.50 (12.7)	White	3	10		
LC-4	2519	1.00 (25.4)	0.75 (19.1)	White	5	10		
LC-2	2525	1.00 (25.4)	1.00 (25.4)	White	7	10		
LC-8	3807	1.50 (38.1)	0.28 (7.0)	White	1	16		
LC-11	3813	1.50 (38.1)	0.50 (12.7)	White	3	16		
LC-5	3819	1.50 (38.1)	0.75 (19.1)	White	5	16		
LC-1	3832	1.50 (38.1)	1.25 (31.8)	White	9	16		

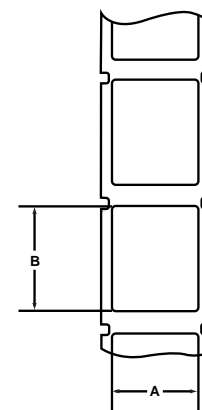

[‡] Similar information for other text sizes provided in LS3E manual

* Order number of rolls required in multiples of Std. Pkg. Qty.

Laminated Label

- Print and apply top white label and overlaminate with clear bottom label
- Material: GMV3 Vinyl



Part Number	Label Code	Print-On Label Size A x B In. (mm)	Overlamine Label Size A x C In. (mm)	Normal Text‡		Labels/ Roll	Std. Pkg.*
				Lines Per Label	Characters Per Line		
LWS-11P	3819	1.50 x 0.75 (38 x 19)	1.50 x 1.75 (38 x 25)	5	16	100	1 Roll

‡ Similar information using other text sizes available in LS3E Manual

* Order number of rolls required in multiples of Std. Pkg.

Terminal Block Labels

- Used to make on-demand terminal block label strips
- 35 ft. (10.7 m) continuous roll
- Material: White Vinyl Cloth

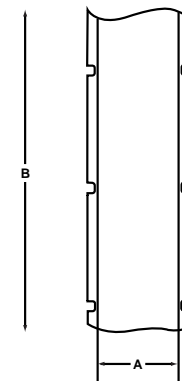

Part Number	Label Code	Width A In. (mm)	Length B Ft. (m)	Labels Per Roll	Std. Pkg. Qty.*
LC-14	0900	0.31 (7.9)	35 ft. (10.7 m)	1	1 Roll
LC-15	1000	0.38 (9.5)	35 ft. (10.7 m)	1	

* Order number of rolls required in multiples of Std. Pkg. Qty.

Asset / Quality Assurance Labels



LC-38



LC-39



LC-40



LC-41

Part Number	Label Code	Width A In. (mm)	Length B In. (mm)	Material	Color (Legend/ Background)	Labels Per Roll	Std. Pkg. Qty.*
LC-38	3611	1.50 (38.1)	0.75 (19.1)	Polyester	Black/Silver	250	1 Roll
LC-39	3811	1.50 (38.1)	0.75 (19.1)	Vinyl Cloth	Green/White	250	
LC-40	3813	1.50 (38.1)	0.75 (19.1)	Vinyl Cloth	Black/White	250	
LC-41	3617	1.50 (38.1)	0.75 (19.1)	Polyester	Black/Silver	250	

* Order number of rolls required in multiples of Std. Pkg. Qty.

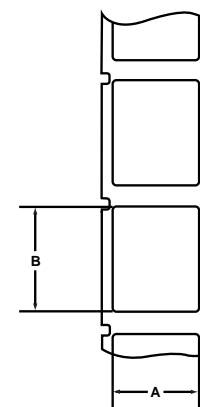

LS5 and LS5E Industrial Labeling Systems

Hand-held, portable labeling systems designed to meet the rugged demands of industrial labeling applications



Produces:

- Self-laminating labels and wire markers
- Continuous laminated tape including bar codes
- Non-laminated commercial tapes
- Heat shrink wire markers
- Tamper-evident labels
- Die-cut labels

Mechanical Information

Print Method:	Thermal transfer printing
Size:	Height: 4.5" H x 6.0" W x 11.5" D (114 mm x 152 mm x 292 mm) Weight: 4.7 lbs. (2.1 kg) with batteries
Graphics Resolution:	203 dpi
Interface:	PCMCIA application card interface
Communications:	RS232 serial communication port
Display:	Two-line x 16 character display
Operating Temperature:	32° to 104°F (0° to 40°C)
Power Source:	6 C-Cell Ni-Cad batteries (Included) UL Listed, CSA Approved Power Adapter (Optional)

Choose the System which best suits your application:

	LS5 Printer Part Number: LS5-KIT	LS5 Data-Comm Printer Part Number: LS5-KITDC	LS5E Enhanced Printer Part Number: LS5E
Usable Memory	16K	16K	450K
Inherent Bar Codes	Code 39, Code 128, Codabar, I 2 of 5, EAN 8, EAN 13, UPC A, UPC E	Code 39, Code 128, Codabar, I 2 of 5, EAN 8, EAN 13, UPC A, UPC E	Code 39, Code 128, Codabar, I 2 of 5, EAN 8, EAN 13, UPC A, UPC E, PDF417, MSI Plessey
Enhanced Printer Features	—	—	Time and Date Clock Tape Feed Control Annunciator
Prompting Languages	English, Spanish, French, German, Portuguese, Italian	English, Spanish, French, German, Portuguese, Italian	English, Spanish, French, German, Portuguese, Italian, Swedish, Danish, Dutch, Norwegian and Finish
Print Styles	Outline, Shadow, Underline, Bold, Frame, Italic, Mirror and Rotated	Outline, Shadow, Underline, Bold, Frame, Italic, Mirror and Rotated	Underline, Bold, Frame, Italic, Mirror and Rotated
Edit Feature	Yes	Yes	Yes
Alpha/Numeric Sequencing	Yes	Yes	Yes
Repeat 999 times	Yes	Yes	Yes
Left/Right/Center Justification	Yes	Yes	Yes
Scaling	Yes	Yes	Yes
Up to 6 Lines of Text	Yes	Yes	Yes
Data-Comm Templates	No	Yes	No

Printers

Part Number	Description	Std. Pkg. Qty.*
LS5-KIT	Industrial Labeling System Kit: (Includes LS5 Printer, 6 C-Cell Ni-Cad Batteries, Ni-Cad Battery Charger, one LS5-33 Laminated 1" Industrial Tape Cartridge, 8 resident bar code fonts)	1
LS5-KITDC	Data-Comm Labeling System Kit: same components as LS5-KIT above, plus preloaded with Data-Comm Label Formats	
LS5E	Enhanced Industrial Labeling System Kit: (Includes LS5E Printer, 6 C-Cell Ni-Cad Batteries, Ni-Cad Battery Charger, one LS5-33 Laminated 1" Industrial Tape Cartridge, one 9 pin null modem cable, 10 resident bar code fonts)	1

PANDUIT® LS5 and LS5E Industrial Portable Labeling Systems

Accessories

Part Number	Description	Std. Pkg. Qty.*
LS5-1	Replacement Battery Charger	1
LS5-2	Soft Sided Carrying Case (Optional)	1
LS5-3	Hand Strap (Optional)	1
LS5-60	AC Power Supply (Optional)	1
LS5-DCT	Data-Comm Templates Disk and 9-pin null modem cable	1

Part Number	Description	Std. Pkg. Qty.*
LS5-D	WINDOWS [®] Driver Disk (Optional) For WINDOWS 3.1, 3.11 and 95	1
PTR-CLN	Printer Cleaning Kit; Contains 4 oz. (116 ml) bottle cleaning solution with MSDS, cleaning pen, 100 swabs, 12 alcohol wipes and instructions	1

*Order number of pieces required in multiples of Std. Pkg. Qty.
[^] WINDOWS is a registered trademark of Microsoft Corporation

Selecting the Correct Font Size

The charts below show the Font Point Size to use based on the tape or tubing size used and lines of text desired:

Tape Width In. (mm)	Lines of Text					
	1 Line	2 Lines	3 Lines	4 Lines	5 Lines	6 Lines
0.50 (12.7)	30 pt	14 pt	8 pt	6 pt	—	—
0.80 (20.3)	55 pt	24 pt	16 pt	12 pt	9 pt	7 pt
1.00 (25.4)	72 pt	33 pt	21 pt	16 pt	12 pt	10 pt

Tubing Diameter In. (mm)	Lines of Text					
	1 Line	2 Lines	3 Lines	4 Lines	5 Lines	6 Lines
0.25 (6.4)	24 pt	10 pt	6 pt	—	—	—
0.38 (9.5)	36 pt	16 pt	10 pt	8 pt	6 pt	—
0.50 (12.7)	46 pt	20 pt	13 pt	10 pt	7 pt	6 pt

Laminated Industrial Tape Cartridges

- Laminated Industrial Tape is designed for tough jobs and can withstand extremes of heat and cold, resist abrasion, UV light exposure, and the most commonly used chemicals and solvent

Part Number	Tape Width In. (mm)	Tape Length Ft. (m)	Legend/ Background Color	Std. Pkg. Qty.*
LS5-530	0.50 (12.7)	40 (12.2)	Black/Clear	1
LS5-533			Black/White	1
LS5-535			Red/White	1
LS5-537			Black/Red	1
LS5-538			Black/Yellow	1
LS5-544			White/Black	1
LS5-547			White/Blue	1
LS5-548			White/Red	1
LS5-70			0.80 (20.3)	40 (12.2)
LS5-72	Red/Clear	1		
LS5-73	Black/White	1		
LS5-74	Blue/White	1		
LS5-75	Red/White	1		
LS5-77	Black/Red	1		
LS5-78	Black/Yellow	1		
LS5-79	Black/Green	1		
LS5-82	White/Clear	1		
LS5-87	White/Blue	1		
LS5-88	White/Red	1		
LS5-89	White/Green	1		
LS5-90	Black/Orange	1		

Part Number	Tape Width In. (mm)	Tape Length Ft. (m)	Legend/ Background Color	Std. Pkg. Qty.*
LS5-30	1.00 (25.4)	40 (12.2)	Black/Clear	1
LS5-32			Red/Clear	1
LS5-33			Black/White	1
LS5-34			Blue/White	1
LS5-35			Red/White	1
LS5-37			Black/Red	1
LS5-38			Black/Yellow	1
LS5-39			Black/Green	1
LS5-42			White/Clear	1
LS5-44			White/Black	1
LS5-47			White/Blue	1
LS5-48			White/Red	1
LS5-49			White/Green	1
LS5-50			Black/Orange	1

*Order number of cartridges required in multiples of Std. Pkg. Qty.

Laminated Tamper-Evident Tape Cartridge

Part Number	Tape Width In. (mm)	Tape Length Ft. (m)	Legend/ Background Color	Std. Pkg. Qty.*
LS5-33T	1.00 (25.4)	40 (12.2)	Black/White	1

*Order number of cartridges required in multiples of Std. Pkg. Qty.

PANDUIT® LS5 and LS5E Industrial Portable Labeling Systems

- Non-Laminated Commercial Tape Supply is designed for indoor applications where abrasion and chemical resistance are not required.

Non-Laminated Commercial Tape Cartridge

Part Number	Tape Width In. (mm)	Tape Length Ft. (m)	Legend/Background Color	Std. Pkg. Qty.*
LS5-30C	1.00 (25.4)	4.00 (12.2)	Black/Clear	1
LS5-33C			Black/White	1
LS5-35C			Red/White	1
LS5-38C			Black/Yellow	1



Electronic Component Labeling

Die-Cut Label Cartridges

Part Number	Material	Color	Label Size Width x Length In. (mm)	Labels/Cartridge	Std. Pkg. Qty.*
LS5-17	Polyester	White	0.50 x 1.00 (12.7 x 25.4)	174	1
LS5-18	Polyester	White	0.66 x 3.44 (16.8 x 87.4) File Folder Size	92	1
LS5-19	Synthetic Paper	White	0.66 x 3.44 (16.8 x 87.4) File Folder Size	92	1
LS5-20	Synthetic Paper	White	1.00 x 4.00 (25.4 x 101.6)	82	1



Marking Wires and Cables

Self-Laminating Wire Marker Cartridges

Part Number	Material	Print-On Area Color	Label Size Width x Length In. (mm)	Print-On Area Width x Length In. (mm)	Nominal Cable O.D. # In. (mm)	Labels/Cartridge	Std. Pkg. Qty.*
LS5-11	Vinyl	White	1.00 x 0.75 (25.4 x 19.1)	1.00 x 0.38 (25.4 x 9.5)	0.12 - 0.12 (3.1 - 3.1)	200	1
LS5-12	TEDLAR [▲]	White	1.00 x 0.75 (25.4 x 19.1)	1.00 x 0.38 (25.4 x 9.5)		200	1
LS5-13	Vinyl	White	1.00 x 1.25 (25.4 x 31.8)	1.00 x 0.50 (25.4 x 12.7)	0.16 - 0.24 (4.1 - 6.1)	160	1
LS5-14	TEDLAR	White	1.00 x 1.25 (25.4 x 31.8)	1.00 x 0.50 (25.4 x 12.7)		160	1
LS5-15	Vinyl	White	1.00 x 2.50 (25.4 x 63.5)	1.00 x 0.75 (25.4 x 19.1)	0.24 - 0.56 (6.1 - 14.2)	110	1
LS5-16	TEDLAR	White	1.00 x 2.50 (25.4 x 63.5)	1.00 x 0.75 (25.4 x 19.1)		110	1
LS5-10	Vinyl	White	1.00 x 4.00 (25.4 x 101.6)	1.00 x 1.00 (25.4 x 25.4)	0.32 - 0.95 (8.1 - 24.1)	83	1

[▲]TEDLAR is a registered trademark of E.I. DuPont Co.

*Refer to Wire Size Selection Guide on [page 196](#) to review diameters of commonly used cables



Flattened Polyolefin Heat Shrink Tubing Supply Cartridges

Part Number	Diameter In. (mm)	Nominal Cable O.D. # In. (mm)	Color	Length In. (mm)	Std. Pkg. Qty.*
LS5-HS3	0.25 (6.4)	0.08 - 0.25 (2.1 - 6.4)	Black/White	100 (2540)	1
LS5-HS4	0.38 (9.5)	0.13 - 0.38 (3.2 - 9.5)			1
LS5-HS5	0.50 (12.7)	0.17 - 0.50 (4.2 - 12.7)			1
LS5-HS8	0.25 (6.4)	0.08 - 0.25 (2.1 - 6.4)	Black/Yellow	100 (2540)	1
LS5-HS9	0.38 (9.5)	0.13 - 0.38 (3.2 - 9.5)			1
LS5-HS10	0.50 (12.7)	0.17 - 0.50 (4.2 - 12.7)			1

*Refer to Wire Size Selection Guide on [page 196](#) to review diameters of commonly used cables

- Service Temperature Range: -22°F to 220°F (-30°C to 105°C)
- Shrink Ratio 3:1 @ 212°F (100°C)
- Flammability: Meets U.L. Standard 224 for flammability

See [page 25](#) for Heat Shrink Tools and Accessories

*Order number of cartridges required in multiples of Std. Pkg. Qty.

LS4H Heat Shrink Tube Marking System

High performance, self-contained marking system that produces heat shrink tube markers for wire and cable identification and laminated component markers.



- Provides durable, high quality permanent tube markers
- Indestructible 3:1 flattened polyolefin heat shrink tubing cartridge meets UL-224 requirements
- Laminated tape cartridge supplies built in thermal transfer ribbon that prints up to four sizes of text on 0.50" (12.7mm) wide adhesive tape
- Can also be powered by 4 D-Cell Ni-Cad batteries in locations where power is not available

Printer Features

- Prints in 4 standard font sizes: 8, 10, 12, and 16 point Helvetica
- Prints in **bold type** or underline text for positive identification of numbers
- Prints markers either horizontally or vertically
- Scratch resistant marking
- Repeat legend up to 99 times, eliminating the need to re-key repetitive information
- Automatic alpha and numeric sequencing saves time
- Legend can be centered automatically on tube size selected



Vertical and underlining capability



Automatic Sequencing



Repeat for short runs



Scratch resistant marking

Printer and Accessories

Part Number	Description	Std. Pkg.*
LS4H	Heat Shrink Tube Marker Kit: Includes LS4H Printer, 115 VAC Power Adaptor, one black / white cartridge 0.19" (4.8mm) tubing, and one black / white cartridge 0.25"(6.4mm) tubing	1
LS4-60	Replacement 115 VAC Power Adaptor	1
LS4-53	Ni-Cad Battery Charger (Optional)	1
LS4H-7	Black Carrying Case (Optional)	1
LS4H-9	Scissors (Optional)	1

Laminated Industrial Supply Cartridges

Part Number	Width In. (mm)	Length Ft. (m)	Color	Std. Pkg.*
LS4H-30I	0.50 (12.7)	50 (15.2)	Black/Clear	1
LS4H-33I	0.50 (12.7)	50 (15.2)	Black/White	1
LS4H-37I	0.50 (12.7)	50 (15.2)	Black/Red	1
LS4H-38I	0.50 (12.7)	50 (15.2)	Black/Yellow	1

Heat Shrink Tubing Supply Cartridges

- Material: Flattened Polyolefin
- Shrink ratio 3:1 @ 212°F (100°C)
- Flammability: Meets U.S. Standard 224 for flammability
- Used with Panduit Heat Shrink Tools and Accessories shown on [page 25](#)

Part Number	Diameter In. (mm)	Nominal Cable O.D. In. (mm)	Length In. (mm)	Color	Std. Pkg.*
LS4H-1	0.13 (3.2)	0.04 - 0.13 (1.1 - 3.2)	100 (2540)	Black/White	1
LS4H-2	0.19 (4.8)	0.06 - 0.19 (1.6 - 4.8)	100 (2540)		1
LS4H-3	0.25 (6.4)	0.08 - 0.25 (2.1 - 6.4)	100 (2540)		1
LS4H-4	0.13 (3.2)	0.04 - 0.13 (1.1 - 3.2)	100 (2540)	Black/Yellow	1
LS4H-5	0.19 (4.8)	0.06 - 0.19 (1.6 - 4.8)	100 (2540)		1
LS4H-6	0.25 (6.4)	0.08 - 0.25 (2.1 - 6.4)	100 (2540)		1

*Order number of Std. Pkgs. required in multiples of Std. Pkg. Qty.

LS4M Multiple Line Portable Labeling System

High performance, self-contained labeling system that prints up to four lines of text on 0.50" (12.7 mm) wide adhesive tape.



- Laminated, adhesive backed polyester tape is heat and scratch resistant, supplied in convenient cartridges
- Label cartridges feature built-in thermal transfer ribbon, overlamine and cutter for trouble-free performance
- Indestructible polyester laminate insures no loss of readability
- Compact, portable size allows usage anywhere
- Use with AC Power Adapter (included) or four Ni-Cad batteries (not included)

Printer Features

- Prints in 3 standard font sizes 6, 8, and 12 point Helvetica
- Prints in bold, outline, vertical, negative image, mirror image, shadow and underline
- Prints marker either horizontally or vertically
- Automatic alpha and numeric sequencing
- Prints up to 15 characters per second
- Text may be scaled 2X for larger more legible print
- 16-character display screen allows text verification prior to printing
- Prints from 1-4 lines on single strip of tape



Circuit board labeling



Label switches, relays and other devices



Telecommunications labeling



Inventory and bin-marking

Printer and Accessories

Part Number	Description	Std. Pkg.*
LS4M	Multiple Line Labeling System (Includes AC Power Adapter, batteries not included)	1
LS4-60	Replacement 115 VAC Power Adapter	1
LS4-53	Ni-Cad Battery Charger (Optional)	1
LS4-54	3 of 9 Bar Code Font Card (Optional)	1
LS4-57	6 point Helvetica Regular Font Card (Optional)	1
LS4-58	18 point Helvetica Regular Font Card (Optional)	1
LS4-59	36 point Helvetica Regular Font Card (Optional)	1
LS4H-7	Black Carrying Case (Optional)	1

LS4M Industrial Labeling Tape (Heavy duty, outdoor)

- Withstand extremes of heat and cold, resist abrasion, UV light exposure, and the most commonly used chemicals and solvents.

Part Number	Width In. (mm)	Length Ft. (m)	Color	Std. Pkg.*
LS4-30I	0.50 (12.7)	50 (15.2)	Black/Clear	1
LS4-33I			Black/White	1
LS4-38I			Black/Yellow	1
LS4-42I			White/Clear	1
LS4-44I			White/Black	1

Standard Labeling Tapes

- Designed for indoor applications where abrasion and chemical resistance are not required

Part Number	Width In. (mm)	Length Ft. (m)	Color	Std. Pkg.*
LS4-30	0.50 (12.7)	50 (15.2)	Black/Clear	1
LS4-31			Blue/Clear	1
LS4-32			Red/Clear	1
LS4-33			Black/White	1
LS4-34			Blue/White	1
LS4-35			Red/White	1
LS4-36			Black/Blue	1
LS4-37			Black/Red	1
LS4-38			Black/Yellow	1
LS4-39			Black/Green	1
LS4-42			White/Clear	1
LS4-43			Green/White	1
LS4-44			White/Black	1
LS4-45			Black/Silver	1
LS4-46			Black/Gold	1
LS4-47			White/Blue	1
LS4-48			White/Red	1
LS4-49			White/Green	1
LS4-50			Black/Orange	1

PTR1 Flat-Bed, Dot-Matrix Printer



Produces Custom Markers Instantly!

- Use with Panduit Dot-Matrix and Heat Shrink labels
- Use with Panduit **ON-DEMAND™** Wire Marker Cards
- Provides excellent print quality and sharp, permanent characters
- Adjustable print head gap eliminates smearing, especially on thick material
- Straight label path eliminates the potential for jamming or peeling of labels
- Durable rugged metal construction is ideal for industrial environments
- Compatible with **PAN-MARK™** for **WINDOWS^ 2.X** or higher, **PAN-MARK LT** and **PROG-LITE** Labeling Software Programs (see [pages 27-32](#) for complete software product information).

Mechanical Information

Print Method: 24-pin dot-matrix print head

Size:

Height:	4.8"	(122 mm)
Width:	15.1"	(384 mm)
Depth:	7.5"	(190 mm)
Weight:	10 lbs.	(4.5 kg)

Print Speed: Draft: 166 Characters Per Second
Near Letter Quality: 83 Characters Per Second

Print Buffer: 8 KB

Graphics Horizontal: 180 dpi

Resolution: Vertical: 120 dpi

Forms Control: Adjustable width tractors accommodate 1.50" (38.1 mm) to 10.25" (260.3 mm) width pinfeed forms

Interface and Communications: Centronics parallel 36 pin and DB25 (RS232) serial interface

Ribbon Width: 0.50" (12.7 mm)

Voltage: Autoranging 115 VAC +/- 10% to 230 VAC +/- 10%

Fuse: 1 Amp Fast-Blow for 115/230 VAC

Part Number	Description	Std. Pkg. Qty.*
PTR1	Dot-Matrix Printer Kit (Includes Printer, AC Power Cord, Operator Manual and Indelible Ribbon)	1
PTR1-AC	Replacement AC Power Cord up to 115V	1
PTR1-AC220	Replacement AC Power Cord up to 220V	1
PTR1-RIB	Replacement Indelible Ink Ribbon	1
PTR1-STD	Standard Ink Ribbon (Optional)	1
PTR1-MAN	Replacement PTR1 Operating Manual	1
PTR-CLN	Printer Cleaning Kit Contains 4 oz. (116 ml) bottle cleaning solution with MSDS, cleaning pen, 100 swabs, 12 alcohol wipes and instructions	1

*Order number of printers or accessories required in multiples of Std. Pkg. Qty.

^WINDOWS is a registered trademark of Microsoft Corp.

Computer Printable Heat Shrink Tubing for Permanent Wire and Cable Identification



- Pre-cut tubing mounted on pin-fed plastic carrier
- Material: Flattened Polyolefin
- Service Temperature Range: -22°F to 220°F (-30°C to 105°C)
- Shrink Ratio 3:1 @ 212°F (100°C)
- Flammability: Meets U.L. Standard 224 for flammability
- Use with Panduit Heat Shrink Tools and Accessories shown on [page 25](#)

Part Number	Diameter In. (mm)	Marker Width In. (mm)	Markers Per Row	Nominal Cable Outside Diameter [■] In. (mm)	Carrier Width In. (mm)	Color	Markers Per Roll	Std. Pkg. Qty.*
LHS12W1	0.13 (3.2)	2.00 (50.8)	1	0.04 - 0.13 (1.1 - 3.2)	3.50 (88.9)	White	500	1
LHS12W2	0.13 (3.2)	1.00 (25.4)	2				1000	1
LHS12W4	0.13 (3.2)	0.50 (12.7)	4				2000	1
LHS18W1	0.18 (4.8)	2.00 (50.8)	1	0.06 - 0.18 (1.6 - 4.8)			500	1
LHS18W2	0.18 (4.8)	1.00 (25.4)	2				1000	1
LHS18W4	0.18 (4.8)	0.50 (12.7)	4				2000	1
LHS25W1	0.25 (6.4)	2.00 (50.8)	1	0.08 - 0.25 (2.1 - 6.4)			500	1
LHS25W2	0.25 (6.4)	1.00 (25.4)	2				1000	1
LHS25W4	0.25 (6.4)	0.50 (12.7)	4				2000	1
LHS50W1	0.50 (12.7)	2.00 (50.8)	1	0.17 - 0.50 (4.2 - 12.7)			500	1
LHS50W2	0.50 (12.7)	1.00 (25.4)	2				1000	1
LHS12Y1	0.13 (3.2)	2.00 (50.8)	1	0.04 - 0.13 (1.1 - 3.2)			3.50 (88.9)	Yellow
LHS12Y2	0.13 (3.2)	1.00 (25.4)	2		1000	1		
LHS12Y4	0.13 (3.2)	0.50 (12.7)	4		2000	1		
LHS18Y1	0.18 (4.8)	2.00 (50.8)	1	0.06 - 0.18 (1.6 - 4.8)	500	1		
LHS18Y2	0.18 (4.8)	1.00 (25.4)	2		1000	1		
LHS18Y4	0.18 (4.8)	0.50 (12.7)	4		2000	1		
LHS25Y1	0.25 (6.4)	2.00 (50.8)	1	0.08 - 0.25 (2.1 - 6.4)	500	1		
LHS25Y2	0.25 (6.4)	1.00 (25.4)	2		1000	1		
LHS25Y4	0.25 (6.4)	0.50 (12.7)	4		2000	1		
LHS50Y1	0.50 (12.7)	2.00 (50.8)	1	0.17 - 0.50 (4.2 - 12.7)	500	1		
LHS50Y2	0.50 (12.7)	1.00 (25.4)	2		1000	1		

[■]Refer to Wire Size Selection Guide on [page 196](#) to review diameters of commonly used cables

*Order number of rolls required in multiples of Std. Pkg. Qty

For information on our complete line of Dot-Matrix Labels and Data Plates that can be used with the PTR1 Dot-Matrix Printer, see [pages 80-125](#).

ON-DEMAND™ Wire Marker Cards for Standard and Custom Wire Markers



Marker card rolls make the process easy. Simply create the custom legend using **PROG-LITE** Label Printing Software...



...print using the PTR1 Printer and tear off the plastic liner. Your custom card is ready to go!

BLANK CLOTH MARKER (Perforated to provide half markers)



36 Markers Per Card



33 Markers Per Card



25 Markers Per Card



20 Markers Per Card



18 Markers Per Card

Part Number	Material	Markers Per Card	Print-On Area Width x Length In. (mm)	Total Marker Size Width x Length In. (mm)	Characters Per Line Per Marker†	Std. Pkg. Qty*
PCM36R-TL	White Vinyl Cloth	36	0.25 x 1.50 (6.4 x 38.1)	0.25 x 1.50 (6.4 x 38.1)	1 to 2	250
PCM33R-TL		33	0.27 x 1.50 (6.9 x 38.1)	0.27 x 1.50 (6.9 x 38.1)	1 to 2	250
PCM25R-TL		25	0.36 x 1.50 (9.1 x 38.1)	0.36 x 1.50 (9.1 x 38.1)	1 to 3	250
PCM20R-TL		20	0.45 x 1.50 (11.3 x 38.1)	0.45 x 1.50 (11.3 x 38.1)	1 to 4	250
PCM18R-TL		18	0.50 x 1.50 (12.6 x 38.1)	0.50 x 1.50 (12.6 x 38.1)	1 to 5	250
PCM36RY-TL	Yellow Vinyl Cloth	36	0.25 x 1.50 (6.4 x 38.1)	0.25 x 1.50 (6.4 x 38.1)	1 to 2	250
PCM33RY-TL		33	0.27 x 1.50 (6.9 x 38.1)	0.27 x 1.50 (6.9 x 38.1)	1 to 2	250
PCM25RY-TL		25	0.36 x 1.50 (9.1 x 38.1)	0.36 x 1.50 (9.1 x 38.1)	1 to 3	250
PCM20RY-TL		20	0.45 x 1.50 (11.3 x 38.1)	0.45 x 1.50 (11.3 x 38.1)	1 to 4	250
PCM18RY-TL		18	0.50 x 1.50 (12.6 x 38.1)	0.50 x 1.50 (12.6 x 38.1)	1 to 5	250

*Order number of cards required in multiples of Std. Pkg. Qty.
To order 100 cards/roll substitute "-C" for "-TL" in the above part numbers.
For example PCM36R-TL = 250 cards/roll. PCM36R-C = 100 cards/roll.
† Print 6 lines of identical information on each individual full size cloth marker.
Print 3 lines of identical information on each half size cloth marker.

See [page 30](#) for information on **PROG-LITE** Labeling Software to generate **ON-DEMAND** Marker Cards

DURA-MARK™ PTR2 Thermal Transfer Printer And Accessories



Create a variety of high quality, custom labels

- *It's Quick!* — Custom capability allows labels to be produced in-house, anytime, anywhere.
- Choose from an assortment of colored thermal transfer rolls, self-laminating wire markers, blank labels and heat shrink markers shown on **pages 21-25**.
- Print legends up to 3.5" (89 mm) high.
- Works with most standard PC's and label printing software including Panduit® **PAN-MARK™ 2.X** or higher for **WINDOWS^** Label Printing Software (See **page 28** for complete software information).

Mechanical Information

Print Method: Thermal transfer and direct thermal printing

Size:
 Height: 5.3" (135 mm)
 Width: 7.9" (200 mm)
 Depth: 8.9" (226 mm)
 Weight: 4 lbs. (1.8 kg)

Print Speed: Select constant print speeds of 1", 1.5" or 2" (25.4, 38.1, or 50.8 mm) per second

Media:
 Roll Width: 1.1" - 4.6" (28 mm - 118 mm)
 Max. Roll Diameter: 3.8" (96 mm)
 Core Diameter: 1.0" (25 mm)
Use PTR2-RS Roll Stand for rolls with a core diameter > 1.0" (25 mm)

Memory: 128 Kb Standard

Double Buffer: Contains a double buffer which makes the printer capable of printing continuously from WINDOWS

Sensors: See through sensor designed for die-cut labels

Graphics Resolution: Up to 203 dpi

Print Information

- Fonts can be printed in four directions: 0°, 90°, 180° and 270°
- Capable of reverse print, bar coding and graphics
- Prints up to 32" (813 mm) length x 3.5" (89 mm) high characters
- 4.09" (104 mm) maximum print width
- Capable of horizontal and vertical print

Part Number	Description	Std. Pkg. Qty*
PTR2	Thermal Transfer Printer	1
PTR2-RS	External Label Roll Stand <i>Used to rear feed labels that are not supplied on 1.00" (25.4 mm) cores</i>	1
PTR-CLN	Printer Cleaning Kit Contains 4 oz. (116 ml) bottle cleaning solution with MSDS, cleaning pen, 100 swabs, 12 alcohol wipes and instructions	

*Order number required in multiples of Std. Pkg. Qty.

^WINDOWS is a trademark of Microsoft Corp.

PTR2 Ribbons and Continuous Roll Supplies

Thermal Transfer Ribbons

Part Number	Material	Size Width x Length	Use	Color	Std. Pkg. Qty*
TTR-BL	Resin	4.33" x 280' (110.0 mm x 85.3 m)	Vinyl and Polyester Applications	Black	1
TTR2-BL	Resin	2.50" x 280' (63.5 mm x 85.3 m)		Black	1
TTR-WH	Resin	4.33" x 262' (110.0 mm x 79.8 m)		White	1
TTR2-WH	Resin	2.50" x 262' (63.5 mm x 79.8 m)		White	1
TTRW-BL	Wax	4.33" x 280' (110.0 mm x 85.3 m)	Self-Laminating Labels, Heat Shrink Labels and Paper Labels	Black	1
TTRW2-BL	Wax	2.50" x 280' (63.5 mm x 85.3 m)		Black	1

*Order number of ribbons required in multiples of Std. Pkg. Qty.

Roll Material Selection Guide

Material Type	Temperature Range	Key Feature	Color	Outdoor Rated	Hazardous Environment	UL Rec.	CSA
TTPA Paper	-65° to 160°F (-54° to 71°C)	Standard paper material for general indoor labeling	White	No	No	No	No
TTV Vinyl	-40° to 176°F (-40° to 80°C)	Conformable material for flat applications in indoor or outdoor environments. Can be overlaminated with clear polyester material to increase durability	White Yellow Red Green Blue Orange	Yes, 2 years	No	No	No
TTP Polyester	0° to 275°F (-18° to 135°C)	TTP2-CLR/TTP4-CLR are used to produce markers with a clear background; TTP2-LAM/TTP4-LAM are used as an overlaminate to increase durability of vinyl or paper markers	Clear	Yes, 2 years	No	No	No



2" (50.8 mm) Wide Rolls

Part Number	Description	Roll Width In. (mm)	Roll Length Ft. (m)	Color	Material	Std. Pkg. Qty*
TTP2-CLR	Thermal Transfer Roll	2.00 (50.8)	100 (30.5)	Clear	Polyester	1
TTV2-WHT TTV2-YEL TTV2-RED TTV2-GRN TTV2-BLU TTV2-ORG	Thermal Transfer Roll	2.00 (50.8)	100 (30.5)	White Yellow Red Green Blue Orange	Vinyl	1
TTPA2-WHT	Thermal Transfer Roll	2.00 (50.8)	125 (38.1)	White	Paper	1
TTP2-LAM	Overlaminated Roll	2.25 (57.1)	100 (30.5)	Clear	Polyester Overlaminated	1

Rolls are on 1.00" (25.4 mm) cores

*Order number of rolls required in multiples of Std. Pkg. Qty



4" (101.6 mm) Wide Rolls

Part Number	Description	Roll Width In. (mm)	Roll Length Ft. (m)	Color	Material	Std. Pkg. Qty*
TTP4-CLR	Thermal Transfer Roll	4.00 (101.6)	100 (30.5)	Clear	Polyester	1
TTV4-WHT TTV4-YEL TTV4-RED TTV4-GRN TTV4-BLU TTV4-ORG	Thermal Transfer Roll	4.00 (101.6)	100 (30.5)	White Yellow Red Green Blue Orange	Vinyl	1
TTPA4-WHT	Thermal Transfer Roll	4.00 (101.6)	125 (38.1)	White	Paper	1
TTP4-LAM	Overlaminated Roll	4.25 (108.0)	100 (30.5)	Clear	Polyester Overlaminated	1

Rolls are on 1.00" (25.4 mm) cores

*Order number of rolls required in multiples of Std. Pkg. Qty.



PTR2 Self-Laminating Labels



- Designed to identify all sizes of wires and cables quickly and economically
- Overlaminates protects legends for clear, permanent identification
- Available in a variety of sizes and 9 colors
- Vinyl material for indoor applications and TEDLAR[▲] material for outdoor and high temperature applications
- Labels are on 1.0" (25.4 mm) cores for PTR2 Printer

Choose the material that best suits your application:

Material Code	Material Type	Temperature Range	Key Features	Color	Outdoor Rated	Hazardous Environment	UL Rec.	CSA
GMV3	Self-Laminating Vinyl Film	-40°F to 176°F (-40°C to 80°C)	General purpose vinyl self-laminating labels	Clear w/ White Print-On Area	No	No	Yes	Yes
GMT1	Self-Laminating TEDLAR [▲]	0°F to 275°F (-18°C to 135°C)	Self-extinguishing, outdoor rated material; ideal for wire and cable labeling in harsh environments	Clear w/ White Print-On Area	Yes	Yes	Yes	Yes

Part Number	Total Area Width x Length In. (mm)	Print-On Area Width x Length In. (mm)	Labels Per Row	Nominal Cable O.D. * In. (mm)	Color	Material	Std. Pkg. Qty.*
TTSL-247	0.80 x 0.94 (20.3 x 23.9)	0.80 x 0.38 (20.3 x 9.7)	5	0.12 - 0.18 (3.0 - 4.5)	White	Vinyl	5000
TTSL-246	0.80 x 0.94 (20.3 x 23.9)	0.80 x 0.38 (20.3 x 9.7)	5		White	TEDLAR [▲]	5000
TTSL-249	1.00 x 0.75 (25.4 x 19.1)	1.00 x 0.38 (25.4 x 9.7)	4	0.13 - 0.13 (3.0 - 3.0)	White	Vinyl	2500
TTSL-249YL†	1.00 x 0.75 (25.4 x 19.1)	1.00 x 0.38 (25.4 x 9.7)	4		Yellow†	Vinyl	2500
TTSL-248	1.00 x 0.75 (25.4 x 19.1)	1.00 x 0.38 (25.4 x 9.7)	4	0.12 - 0.19 (3.0 - 4.5)	White	TEDLAR	2500
TTSL-251	1.00 x 0.94 (25.4 x 23.9)	1.00 x 0.38 (25.4 x 9.7)	4		White	Vinyl	2500
TTSL-251YL†	1.00 x 0.94 (25.4 x 23.9)	1.00 x 0.38 (25.4 x 9.7)	4		Yellow†	Vinyl	2500
TTSL-250	1.00 x 0.94 (25.4 x 23.9)	1.00 x 0.38 (25.4 x 9.7)	4		White	TEDLAR	2500
TTSL-1	0.50 x 1.50 (12.7 x 38.1)	0.50 x 0.50 (12.7 x 12.7)	8	0.16 - 0.32 (4.0 - 8.1)	White	Vinyl	5000
TTSL-1YL†	0.50 x 1.50 (12.7 x 38.1)	0.50 x 0.50 (12.7 x 12.7)	8		Yellow†	Vinyl	5000
TTSL-53	0.50 x 1.50 (12.7 x 38.1)	0.50 x 0.50 (12.7 x 12.7)	8		White	TEDLAR	5000
TTSL-2	1.00 x 1.50 (25.4 x 38.1)	1.00 x 0.50 (25.4 x 12.7)	4		White	Vinyl	2500
TTSL-2YL†	1.00 x 1.50 (25.4 x 38.1)	1.00 x 0.50 (25.4 x 12.7)	4		Yellow†	Vinyl	2500
TTSL-54	1.00 x 1.50 (25.4 x 38.1)	1.00 x 0.50 (25.4 x 12.7)	4		White	TEDLAR	2500
TTSL-3	2.00 x 1.50 (50.8 x 38.1)	2.00 x 0.50 (50.8 x 12.7)	2		White	Vinyl	1000
TTSL-3YL†	2.00 x 1.50 (50.8 x 38.1)	2.00 x 0.50 (50.8 x 12.7)	2		Yellow†	Vinyl	1000
TTSL-55	2.00 x 1.50 (50.8 x 38.1)	2.00 x 0.50 (50.8 x 12.7)	2		White	TEDLAR	1000
TTSL-4	1.00 x 2.44 (25.4 x 62.0)	1.00 x 1.00 (25.4 x 25.4)	4		0.32 - 0.46 (8.1 - 11.6)	White	Vinyl
TTSL-4YL†	1.00 x 2.44 (25.4 x 62.0)	1.00 x 1.00 (25.4 x 25.4)	4	Yellow†		Vinyl	1500
TTSL-56	1.00 x 2.44 (25.4 x 62.0)	1.00 x 1.00 (25.4 x 25.4)	4	White		TEDLAR	1500
TTSL-5	2.00 x 2.44 (50.8 x 62.0)	2.00 x 1.00 (50.8 x 25.4)	2	White		Vinyl	500
TTSL-5YL†	2.00 x 2.44 (50.8 x 62.0)	2.00 x 1.00 (50.8 x 25.4)	2	Yellow†		Vinyl	500
TTSL-57	2.00 x 2.44 (50.8 x 62.0)	2.00 x 1.00 (50.8 x 25.4)	2	White		TEDLAR	500
TTSL-6	1.00 x 3.94 (25.4 x 100.1)	1.00 x 1.00 (25.4 x 25.4)	4	0.32 - 0.93 (8.1 - 23.7)	White	Vinyl	1000
TTSL-6YL†	1.00 x 3.94 (25.4 x 100.1)	1.00 x 1.00 (25.4 x 25.4)	4		Yellow†	Vinyl	1000
TTSL-58	1.00 x 3.94 (25.4 x 100.1)	1.00 x 1.00 (25.4 x 25.4)	4		White	TEDLAR	1000
TTSL-7	2.00 x 3.94 (50.8 x 100.1)	2.00 x 1.00 (50.8 x 25.4)	2		White	Vinyl	500
TTSL-59	2.00 x 3.94 (50.8 x 100.1)	2.00 x 1.00 (50.8 x 25.4)	2	White	TEDLAR	500	

*Order number of labels required in multiples of Std. Pkg. Qty.

†For other TIA colors, substitute the following suffixes: RD=Red, VL=Violet, BR=Brown, GR=Green, IG=Gray, OR=Orange, BU=Blue

▲TEDLAR is a registered trademark of E.I. DuPont Co.

*Refer to Wire Size Selection Guide on page 196 to review diameters of commonly used cables

PTR2 Blank Labels



- Labels are on 3.0" (76.2 mm) cores and must be rear fed from PTR2 External Stand (see [page 20](#))

Choose the material that best suits your application:

Material Code	Material Type	Temperature Range	Key Features	Color	Outdoor Rated	Hazardous Environment	UL Rec.	CSA
GMP4-W	Destructible Paper	-65°F to 160°F (-54°C to 71°C)	Tamper resistant litho paper for permanent applications	White	No	No	No	No
GMPE4-W	Destructible Polyethylene	-40°F to 176°F (-40°C to 80°C)	Destructible adhesive for permanent applications	White	No	No	No	No
GMY4-C	Clear Polyester	-40°F to 302°F (-40°C to 150°C)	Durable; high temperature; does not stretch or easily tear	Clear	Yes	Yes	No	No
GMY4-W	White Polyester	-40°F to 302°F (-40°C to 150°C)	Durable; high temperature; does not stretch or easily tear	White	Yes	Yes	No	No
GMY4-S	Metallized Polyester	-40°F to 302°F (-40°C to 150°C)	Durable; high temperature; does not stretch or easily tear; protects data EPROM by blocking out light	Silver	Yes	Yes	No	No
GMY4-STE	Tamper Evident Polyester	-40°F to 104°F (-40°C to 40°C)	Destructible material; label cannot be completely removed once applied	Silver	Yes	No	No	No
GMT4-W	TEDLAR *	-40°F to 275°F (-40°C to 135°C)	Indoor/outdoor high temperature labels; Self-extinguishing	White	Yes	Yes	No	No

Part Number	Material	Color	Label Width In. (mm)	Label Length In. (mm)	Horizontal Repeat In. (mm)	Vertical Repeat In. (mm)	Labels Per Row	Web Width In. (mm)	Std. Pkg. Qty.*
TTC3YS-10	Polyester	Silver	0.50 (12.7)	0.44 (11.1)	0.66 (16.8)	0.48 (12.1)	5	3.35 (85.1)	10,000
TTC3Y-10	Polyester	White	0.50 (12.7)	0.44 (11.1)	0.66 (16.8)	0.48 (12.1)	5	3.35 (85.1)	10,000
TTC3YST-10	Tamper Evident Polyester	Silver	0.50 (12.7)	0.44 (11.1)	0.66 (16.8)	0.48 (12.1)	5	3.35 (85.1)	10,000
TTC45Y-1	Polyester	White	0.50 (12.7)	0.75 (19.1)	0.50 (12.7)	0.88 (22.2)	8	4.25 (108.0)	1000
TTC-DS110-1	Polyester	White	0.50 (12.7)	7.88 (200.0)	—	8.13 (206.4)	1	1.25 (31.8)	1000
TTC6Y-10	Polyester	White	0.90 (22.9)	0.25 (6.4)	1.13 (28.6)	0.35 (8.9)	3	3.35 (85.1)	10,000
TTC6T-10	TEDLAR *	White	0.90 (22.9)	0.25 (6.4)	1.13 (28.6)	0.35 (8.9)	3	3.35 (85.1)	10,000
TTC7YS-10	Polyester	Silver	1.00 (25.4)	0.38 (9.5)	1.08 (27.3)	0.48 (12.1)	3	3.35 (85.1)	10,000
TTC7Y-10	Polyester	White	1.00 (25.4)	0.38 (9.5)	1.08 (27.3)	0.48 (12.1)	3	3.35 (85.1)	10,000
TTC8ET-10	Destructible Polyethylene	White	1.00 (25.4)	0.50 (12.7)	1.08 (27.3)	0.60 (15.2)	3	3.35 (85.1)	10,000
TTC8YS-10	Polyester	Silver	1.00 (25.4)	0.50 (12.7)	1.08 (27.3)	0.60 (15.2)	3	3.35 (85.1)	10,000
TTC8YC-10	Polyester	Clear	1.00 (25.4)	0.50 (12.7)	1.08 (27.3)	0.63 (15.9)	3	3.35 (85.1)	10,000
TTC8Y-10	Polyester	White	1.00 (25.4)	0.50 (12.7)	1.08 (27.3)	0.60 (15.2)	3	3.35 (85.1)	10,000
TTC8YST-10	Tamper Evident Polyester	Silver	1.00 (25.4)	0.50 (12.7)	1.08 (27.3)	0.60 (15.2)	3	3.35 (85.1)	10,000
TTC8T-10	TEDLAR *	White	1.00 (25.4)	0.50 (12.7)	1.08 (27.3)	0.60 (15.2)	3	3.35 (85.1)	10,000
TTC-MJ-5	Polyester	Clear	1.38 (34.9)	0.19 (4.8)	—	0.38 (9.5)	1	2.25 (57.2)	5000
TTC-MJWH-5	Polyester	White	1.38 (34.9)	0.19 (4.8)	—	0.38 (9.5)	1	2.25 (57.2)	5000
TTC15P-2.5	Paper	White	1.50 (38.1)	1.00 (25.4)	—	1.63 (41.3)	1	1.75 (44.5)	2500
TTC15Y-2.5	Polyester	White	1.50 (38.1)	1.00 (25.4)	—	1.63 (41.3)	1	1.75 (44.5)	2500
TTC17Y-2.5	Polyester	White	1.63 (41.3)	1.25 (31.8)	—	1.38 (34.9)	1	2.20 (55.9)	2500
TTC-EFPLC-1	Polyester	Clear	1.80 (45.7)	0.38 (9.5)	—	0.63 (15.9)	1	2.25 (57.2)	1000
TTC-EFPL-1	Polyester	White	1.80 (45.7)	0.38 (9.5)	—	0.63 (15.9)	1	2.25 (57.2)	1000
TTC18Y-2.5	Polyester	White	2.00 (50.8)	0.25 (6.4)	—	0.38 (9.5)	1	2.20 (55.9)	2500
TTC19Y-2.5	Polyester	White	2.00 (50.8)	0.50 (12.7)	—	0.60 (15.2)	1	2.20 (55.9)	2500
TTC20YS-2.5	Polyester	Silver	2.00 (50.8)	1.00 (25.4)	—	1.13 (28.6)	1	2.20 (55.9)	2500
TTC20P-2.5	Paper	White	2.00 (50.8)	1.00 (25.4)	—	1.13 (28.6)	1	2.20 (55.9)	2500
TTC20YC-2.5	Polyester	Clear	2.00 (50.8)	1.00 (25.4)	—	1.13 (28.6)	1	2.20 (55.9)	2500
TTC20Y-2.5	Polyester	White	2.00 (50.8)	1.00 (25.4)	—	1.13 (28.6)	1	2.20 (55.9)	2500
TTC20YST-2.5	Tamper Evident Polyester	Silver	2.00 (50.8)	1.00 (25.4)	—	1.13 (28.6)	1	2.20 (55.9)	2500
TTC21P-2.5	Paper	White	2.00 (50.8)	1.25 (31.8)	—	1.38 (34.9)	1	2.20 (55.9)	2500
TTC22YS-2.5	Polyester	Silver	2.75 (69.9)	1.25 (31.8)	—	1.38 (34.9)	1	2.95 (74.9)	2500
TTC22P-2.5	Paper	White	2.75 (69.9)	1.25 (31.8)	—	1.38 (34.9)	1	2.95 (74.9)	2500
TTC22Y-2.5	Polyester	White	2.75 (69.9)	1.25 (31.8)	—	1.38 (34.9)	1	2.95 (74.9)	2500

Labels are roll mounted on 3.00" (76.2 mm) core.
 *Order number of labels required in multiples of Std. Pkg. Qty.
 *TEDLAR is the registered trademark of E. I. DuPont Co.

PTR2 Blank Labels (cont.)

Part Number	Material	Color	Label Width In. (mm)	Label Length In. (mm)	Horizontal Repeat In. (mm)	Vertical Repeat In. (mm)	Labels Per Row	Web Width In. (mm)	Std. Pkg. Qty.*
TTC-EFPL10-1	Polyester	White	2.90 (73.7)	0.30 (7.6)	—	0.55 (14.0)	1	3.25 (82.6)	1000
TTC23Y-2.5	Polyester	White	3.00 (76.2)	0.25 (6.4)	—	0.38 (9.5)	1	3.20 (81.3)	2500
TTC46P-5	Paper	White	3.00 (76.2)	0.94 (23.8)	—	1.06 (27.0)	1	3.35 (85.1)	5000
TTC24YS-2.5	Polyester	Silver	3.00 (76.2)	1.00 (25.4)	—	1.13 (28.6)	1	3.20 (81.3)	2500
TTC24P-2.5	Paper	White	3.00 (76.2)	1.00 (25.4)	—	1.13 (28.6)	1	3.20 (81.3)	2500
TTC24YC-2.5	Polyester	Clear	3.00 (76.2)	1.00 (25.4)	—	1.13 (28.6)	1	3.20 (81.3)	2500
TTC24Y-2.5	Polyester	White	3.00 (76.2)	1.00 (25.4)	—	1.13 (28.6)	1	3.20 (81.3)	2500
TTC24YST-2.5	Tamper Evident Polyester	Silver	3.00 (76.2)	1.00 (25.4)	—	1.13 (28.6)	1	3.20 (81.3)	2500
TTC25YS-1	Polyester	Silver	3.00 (76.2)	2.00 (50.8)	—	2.13 (54.0)	1	3.20 (81.3)	1000
TTC25P-1	Paper	White	3.00 (76.2)	2.00 (50.8)	—	2.13 (54.0)	1	3.20 (81.3)	1000
TTC25YC-1	Polyester	Clear	3.00 (76.2)	2.00 (50.8)	—	2.13 (54.0)	1	3.20 (81.3)	1000
TTC25Y-1	Polyester	White	3.00 (76.2)	2.00 (50.8)	—	2.13 (54.0)	1	3.20 (81.3)	1000
TTC25YST-1	Tamper Evident Polyester	Silver	3.00 (76.2)	2.00 (50.8)	—	2.13 (54.0)	1	3.20 (81.3)	1000
TTC26P-1	Paper	White	3.00 (76.2)	5.00 (127.0)	—	5.13 (130.2)	1	3.20 (81.3)	1000
TTC27Y-10	Polyester	White	3.25 (82.6)	0.31 (7.9)	—	0.44 (11.1)	1	4.20 (106.7)	10,000
TTC28Y-10	Polyester	White	3.25 (82.6)	0.50 (12.7)	—	0.63 (15.9)	1	4.20 (106.7)	10,000
TTC29Y-5	Polyester	White	3.25 (82.6)	0.63 (15.9)	—	0.75 (19.1)	1	4.20 (106.7)	5000
TTC30Y-2.5	Polyester	White	3.25 (82.6)	0.81 (20.6)	—	0.94 (23.8)	1	4.20 (106.7)	2500
TTC31P-1	Paper	White	3.50 (88.9)	1.00 (25.4)	—	1.13 (28.6)	1	3.75 (95.3)	1000
TTC31Y-1	Polyester	White	3.50 (88.9)	1.00 (25.4)	—	1.13 (28.6)	1	3.75 (95.3)	1000
TTC32P-1	Paper	White	3.50 (88.9)	8.00 (203.2)	—	8.13 (206.4)	1	3.75 (95.3)	1000
TTC32Y-1	Polyester	White	3.50 (88.9)	8.00 (203.2)	—	8.13 (206.4)	1	3.75 (95.3)	1000
TTC34P-.5	Paper	White	3.63 (92.1)	4.20 (107.1)	—	4.34 (110.3)	1	4.20 (106.7)	500
TTC33P-.5	Paper	White	3.63 (92.1)	5.79 (147.1)	—	5.92 (150.3)	1	4.20 (106.7)	500
TTC35P-2.5	Paper	White	4.00 (101.6)	1.00 (25.4)	—	4.13 (104.8)	1	4.20 (106.7)	2500
TTC35Y-2.5	Polyester	White	4.00 (101.6)	1.00 (25.4)	—	4.13 (104.8)	1	4.20 (106.7)	2500
TTC36YS-1	Polyester	Silver	4.00 (101.6)	2.00 (50.8)	—	2.13 (54.0)	1	4.20 (106.7)	1000
TTC36P-1	Paper	White	4.00 (101.6)	2.00 (50.8)	—	2.13 (54.0)	1	4.20 (106.7)	1000
TTC36Y-1	Polyester	White	4.00 (101.6)	2.00 (50.8)	—	2.13 (54.0)	1	4.20 (106.7)	1000
TTC37P-1	Paper	White	4.00 (101.6)	3.00 (76.2)	—	3.13 (79.4)	1	4.20 (106.7)	1000
TTC37Y-1	Polyester	White	4.00 (101.6)	3.00 (76.2)	—	3.13 (79.4)	1	4.20 (106.7)	1000
TTC38P-1	Paper	White	4.00 (101.6)	4.00 (101.6)	—	4.13 (104.8)	1	4.20 (106.7)	1000
TTC38Y-1	Polyester	White	4.00 (101.6)	4.00 (101.6)	—	4.13 (104.8)	1	4.20 (106.7)	1000
TTC39P-1	Paper	White	4.00 (101.6)	5.00 (127.0)	—	5.13 (130.2)	1	4.20 (106.7)	1000
TTC39Y-1	Polyester	White	4.00 (101.6)	5.00 (127.0)	—	5.13 (130.2)	1	4.20 (106.7)	1000
TTC40P-1	Paper	White	4.00 (101.6)	6.00 (152.4)	—	6.06 (154.0)	1	4.20 (106.7)	1000
TTC41P-1	Paper	White	4.00 (101.6)	6.50 (165.1)	—	6.63 (168.3)	1	4.20 (106.7)	1000
TTC41Y-1	Polyester	White	4.00 (101.6)	6.50 (165.1)	—	6.63 (168.3)	1	4.20 (106.7)	1000
TTC42P-1	Paper	White	4.00 (101.6)	12.88 (327.0)	—	13.00 (330.2)	1	4.20 (106.7)	500
TTC42Y-1	Polyester	White	4.00 (101.6)	12.88 (327.0)	—	13.00 (330.2)	1	4.20 (106.7)	500

Labels are roll mounted on 3.00" (76.2 mm) core.
 *Order number of labels required in multiples of Std. Pkg. Qty.

PTR2 Heat Shrink Wire and Cable Markers and Accessories



Heat Shrink Wire and Cable Markers

- Produce durable, high quality permanent heat shrink markers
- Pre-cut tubing mounted on plastic carrier
- Service Temperature Range: -22°F to 220°F (-30°C to 105°C)
- Shrink Ratio 3:1 @ 212°F (100°C)
- Flammability: Meets U.L. Standard 224 for flammability
- For best results, print with TTRW-BL Wax Ribbon

Part Number	Diameter In. (mm)	Marker Width In. (mm)	Markers Per Row	Nominal Cable O.D. In. (mm)	Material	Color	Mkrs Per Roll	Std. Pkg. Qty.*
LHS12W1	0.13 (3.2)	2.00 (50.8)	1	0.04 - 0.13 (1.1 - 3.2)	3:1 Flattened Polyolefin	White	500	1
LHS12W2	0.13 (3.2)	1.00 (25.4)	2				1000	1
LHS12W4	0.13 (3.2)	0.50 (12.7)	4				2000	1
LHS18W1	0.18 (4.8)	2.00 (50.8)	1	0.06 - 0.18 (1.6 - 4.8)			500	1
LHS18W2	0.18 (4.8)	1.00 (25.4)	2				1000	1
LHS18W4	0.18 (4.8)	0.50 (12.7)	4				2000	1
LHS25W1	0.25 (6.4)	2.00 (50.8)	1	0.08 - 0.25 (2.1 - 6.4)			500	1
LHS25W2	0.25 (6.4)	1.00 (25.4)	2				1000	1
LHS25W4	0.25 (6.4)	0.50 (12.7)	4				2000	1
LHS50W1	0.50 (12.7)	2.00 (50.8)	1	0.17 - 0.50 (4.2 - 12.7)			500	1
LHS50W2	0.50 (12.7)	1.00 (25.4)	2				1000	1
LHS100W1	1.00 (25.4)	2.00 (50.8)	1	0.33 - 1.00 (8.4 - 25.4)			250	1
LHS100W2	1.00 (25.4)	1.00 (25.4)	2		500	1		
LHS12Y1	0.13 (3.2)	2.00 (50.8)	1	0.04 - 0.13 (1.1 - 3.2)	3:1 Flattened Polyolefin	Yellow	500	1
LHS12Y2	0.13 (3.2)	1.00 (25.4)	2				1000	1
LHS12Y4	0.13 (3.2)	0.50 (12.7)	4				2000	1
LHS18Y1	0.18 (4.8)	2.00 (50.8)	1	0.06 - 0.18 (1.6 - 4.8)			500	1
LHS18Y2	0.18 (4.8)	1.00 (25.4)	2				1000	1
LHS18Y4	0.18 (4.8)	0.50 (12.7)	4				2000	1
LHS25Y1	0.25 (6.4)	2.00 (50.8)	1	0.08 - 0.25 (2.1 - 6.4)			500	1
LHS25Y2	0.25 (6.4)	1.00 (25.4)	2				1000	1
LHS25Y4	0.25 (6.4)	0.50 (12.7)	4				2000	1
LHS50Y1	0.50 (12.7)	2.00 (50.8)	1	0.17 - 0.50 (4.2 - 12.7)			500	1
LHS50Y2	0.50 (12.7)	1.00 (25.4)	2				1000	1
LHS100Y1	1.00 (25.4)	2.00 (50.8)	1	0.33 - 1.00 (8.4 - 25.4)			250	1
LHS100Y2	1.00 (25.4)	1.00 (25.4)	2		500	1		

*Order number of rolls required in multiples of Std. Pkg. Qty.

*Refer to Wire Size Selection Guide on page 196 to review diameters of commonly used cables

PAN-SHRINK Heat Shrink Tools and Accessories

- For use with all Panduit Heat Shrink Markers
- Other Heat Shrink Tools and replacement parts available. Contact factory for details.



Part Number	Description	Std. Pkg. Qty.*
HSG-115V-500	General Purpose Tool – Air intake regulator varies temperature from 500°F (260°C) to 620°F (344°C), 115 Vdlt, 11 AMP. Neoprene jacketed cord with molded strain relief	1
HSG-115V-300	Low Temperature Tool – For use on small sizes of heat shrink when under or near heat sensitive items. Air intake regulator varies temperature from 300°F (145°C) to 450°F (232°C), 115 Volt, 8 AMP. Neoprene jacketed cord with molded strain relief	1
HSG-A1	Shrink tube reflector for tubing up to 0.75" (19.1 mm) inside diameter – Directs heat around the tubing to reduce shrink time.	1
HSG-A2	Shrink tube reflector for tubing up to 1.50" (38.1 mm) inside diameter – Directs heat around the tubing to reduce shrink time.	1
HSG-A3	Shrink tube concentrator – Directs heat toward tubing and away from heat sensitive items.	1
HSG-A4	Black polyethylene case – Stores heat tool, stand and all three accessories.	1

*Order number of heat shrink accessories required in multiples of Std. Pkg. Qty.



PTR3 Thermal Transfer Printer



Fast, rugged printer for high volume applications

- High speed 32-bit RISC processor provides maximum performance at speeds up to 10 inches per second
- Prints on all Panduit Thermal Transfer Labels including self-laminating labels, component labels and heat shrink (see [pages 33-45](#))
- Prints crisp, superior quality 203 dpi resolution images
- Compatible with Panduit® **PAN-MARK™ 2.5 or higher for WINDOWS^** Label Printing Software (See [page 28](#) for complete software information)

Mechanical Information

Print Method: Thermal transfer and direct thermal printing

Size:
 Height: 13.5" (341 mm)
 Width: 10.4" (265 mm)
 Depth: 17.0" (430 mm)
 Weight: 40 lbs. (18 kg)

Print Speed: Up to 10 inches per second (254 mm per second)

Print Width: 4.1" (104 mm)

Media:
 Roll Width: 1.0" - 5.0" (25 mm - 125 mm)
 Min. Core Diameter: 1.5" (38 mm)
 Max. Roll Diameter: 8.6" (220 mm)

Sensors: Adjustable position transmissive sensor for die cut labels and tags.
 Reflective sensor for use with preprinted sensing marks.
 Automatic, programmable setting of top of form.

Resolution: 203 dpi (8 dots/mm)

Print Information

- Inherent Bar Codes:

Bookland	EAN 8	MSI Plessey
Code 39	EAN 13	PDF417
Code 93	Industrial 2 of 5	Postnet
Code 128	Interleaved 2 of 5	UPC-A
CODABAR	Matrix 2 of 5	UPC-E
Data Matrix	Maxicode	

- Text and bar codes can be printed in four directions: 0°, 90°, 180°, 270°
- Character expansion horizontally and vertically in 12 steps
- Dot-addressable graphics
- Sequential numbering
- Form overlay for high speed editing of complex formats

Printer and Accessories

Part Number	Description	Std. Pkg. Qty.*
PTR3	Thermal Transfer Printer	1
PTR-CLN	Printer Cleaning Kit Contains 4 oz. (116 ml) bottle cleaning solution with MSDS, cleaning pen, 100 swabs, 12 alcohol wipes and instructions	1

*Order number of printers required in multiples of Std. Pkg. Qty.

Ribbons

Part Number	Width In. (mm)	Length Ft. (m)	Type	Color	Std. Pkg. Qty.*
TTR4-BL-S	4.30 (109.2)	1181 (360.0)	Resin	Black	1
TTR4W-BL-S			Wax	Black	

*Order number of ribbons required in multiples of Std. Pkg. Qty.

See [pages 33-45](#) for complete label information.

Panduit Software



PAN-MARK for WINDOWS 2.5[^]

Page 28

Part Number: PROG-WIN2

- Designed to be used in WINDOWS
- Extensive bar code, serialization and importing features
- Supports all WINDOWS printer drivers and can be used to drive Panduit LS5E Thermal Transfer Labeling Systems, PTR1 Dot-Matrix Printer, **DURA-MARK™** PTR2 Thermal Transfer Printer and the PTR3 Thermal Transfer Printer (see **pages 12 - 26**)
- Easy to install
- Suggested minimum 486 processor with 8 Mb of RAM



PAN-MARK LT Labeling Software

Page 29

Part Number: PDL-PROG-LT

- Quickest of all DOS packages
- Requires 2 Mb of RAM
- Creates labels quickly and prints quickly
- Used with both dot-matrix and laser printers
- Features serialization, alpha and numeric
- Suggested minimum 286 processor with 2 Mb of RAM



PROG-LITE for DOS Labeling Software

Page 30

Part Number: PROG-LITE

- Used to drive Panduit PTR1 Dot-Matrix Printer to create **ON-DEMAND™** Wire Marker Cards in a DOS environment
- Suggested minimum 286 processor with 2 Mb of RAM



SAFETY EASE™ Marker and Tag Software

Page 31-32

Part Number: SEZ-PM

- Create Custom Electrical Markers, Tags and Pipe Markers
- Can be used with the **DURA-MARK™** PTR2 Thermal Transfer Printer or your own ink jet or laser printer
- Includes pictographs, serialization and the ability to add additional information
- System Requirements: WINDOWS 3.1 or higher, 386 processor or higher, 4 MB RAM for Windows 3.1 and 3.11, 8 MB RAM for Windows 95, 5 MB hard drive space

[^]WINDOWS is a registered trademark of Microsoft Corp.



Easy serialization, bar code, and graphic import options make complex labels seem simple

PAN-MARK™ for WINDOWS^ 2.5

- 21 Resident Bar Code Symbologies
- Ability to create spreadsheets and databases within the program for data import and information storage
- Import data from most Microsoft databases such as EXCEL^ and ACCESS^
- Easy to enter different text on each label — simply type the text and press Page Down for the next label!
- Easy to install and available on CD-ROM
- Includes all of the latest label formats for Panduit Thermal Transfer, Ink Jet, Laser and Dot-Matrix Labels

Software Features

- Uses all WINDOWS printer drivers and can be used to drive Panduit LS5E, PTR1, PTR2 and PTR3 Printers (see pages 12-26)
- ODBC (Open Data-Base Connectivity) allows importing of information from electronic databases such as EXCEL^ and ACCESS^ directly onto the label formats
- Tool menu allows user to add to favorite WINDOWS tools
- Uses a full range of WINDOWS fonts including TrueType* fonts
- Print from 2 pt. to 300 pt. + on the same label
- Panduit label formats ready to use
- Create custom label formats
- Wire Marker designs
- Image and text scaling
- Date, time, series, graphic and data import fields
- Format and label previews
- Print preview
- Multiple print range selection
- Text rotation and alignment

Edit Functions

- Standard copy, cut and paste
- Copy multiple labels
- Remove, Insert and Find a label

Serialization

- Alpha, numeric, octal, hexadecimal and combinations
- Multiple serialized strings in same file
- Easy text and serialization combination
- Insert constants in an existing file



Create multiple legends for wire marking



Bar code pull down menu provides fast and easy editing

Bar Code Features

- Easily create certified bar codes
- Resident Bar Code Symbologies
 - Codabar
 - Code 128 (A, Auto, B, C)
 - Code 39 (Std, Ext)
 - Code 93 (Std, Ext)
 - EAN/JAN 13
 - EAN/JAN 8
 - HIBC/HIBC-LIC
 - Interleaved 2 of 5
 - MSI Plessey
 - PDF 417
 - UCC 128
 - UPC (A, E: 11 Digit, System 0, System 1)
 - Zip+4 Postal Codes

Image Functions

- Import Bitmap (.BMP) graphic images into a label — add you own company logo to labels!
- Copy image from one label to others
- Image library includes common electrical and datacomm symbols

System Requirements

- Designed for 3.1, 3.11, WINDOWS 95, 98 and NT
- Mouse or keyboard driven
- Recommend 486 processor, min. 8 Mb of RAM
- 30 Mb of hard drive space

Part Number	Format	Std. Pkg. Qty.*
PROG-WIN2	3.5" Disks	1
PROG-WIN2CD	CD-ROM	1

*Order number of programs required in multiples of Std. Pkg. Qty.

^WINDOWS is a registered trademark of Microsoft Corp.

*TrueType is a registered trademark of Apple Computing, Inc.

PAN-MARK™ LT Labeling Software

Part Number

PDL-PROG-LT



- Available in 3.5" and 5.25" disk types.

- Fastest label generation of any DOS package
- Designed for anyone who desires a labeling system, but is concerned with cost
- Used with Panduit Computer Printable Labels to meet unique labeling applications



SOFTWARE FEATURES

- Easy to change printers
- Ability to add special ASCII characters to legend
- Context sensitive help screens throughout
- Supplied with 5.25" and 3.5" disks
- Ability to append label files
- Ability to change work directory
- Capacity to add custom label formats
- Supports mouse
- DOS Shell
- Prints without saving
- Pull-down menus and selection of menu colors
- Selection of video mode

EDIT FUNCTIONS

- Copy fields between labels in a file
- Copy fields between label files
- Selection of various character sizes
- Multiple copy of constant text
- Remove label
- Insert label
- Copy label

SERIALIZATION

- Alpha and Numeric
- In conjunction with standard text
- One or several serializations in the same file

SYSTEM REQUIREMENTS

- IBM PC or compatible
- 286 processor or higher
- 2 Mb of RAM (or higher)

SUPPORTED PRINTERS

- ALPS Model 24
- ALPS ASP1000
- Epson EX (Series)
- Epson FX (Series)
- Epson FX-286e
- Epson LQ-800 / 850 / 570 / 870 / 950 / 1000 / 1050 / 2500
- Epson LX
- Epson RX
- HP Laser (in text mode) 10, 12 and 16.7 cpi
- IBM Proprinter X24 / XL24
- Okidata 193 / 320 / 390
- Panasonic KX-P1092 / KX-P1124 / KX-P1524 / KX-P1592 / KX-P1595
- Practical Automation
- NEC Pinwriter 2200 / 5200 / 5300
- Seikosua SP2400

PAN-MARK LT will also work on an Epson or IBM Proprinter X24 / XL24 compatible

PROG-LITE for DOS Labeling Software

Part Number
PROG-LITE

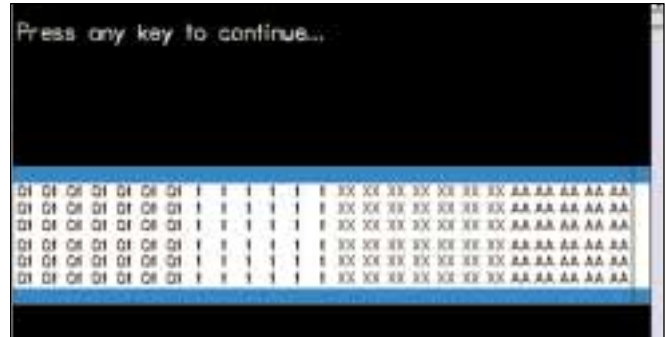

- Used to drive Panduit PTR1 Dot-Matrix Printer to create **ON-DEMAND™** Wire Marker Cards in a DOS environment
- See [page 17](#) for complete information on the Panduit PTR1 Printer
- Provided on 3.5" disks

SYSTEM REQUIREMENTS

- IBM PC or compatible
- 286 processor or higher
- 2 Mb of RAM (or higher)



SAFETY EASE™ Marker and Tag Software

Create Custom Markers and Tags — Just In Time!

- Produce English, Spanish and Bilingual electrical markers, tags and pipe markers with your own computer
- Can be used with the **DURA-MARK™** PTR2 Thermal Transfer Printer or your own ink jet or laser printer
- Requires no instruction manual
- Includes pictographs, serialization and the ability to add additional information
- Installs in less than 5 minutes!
- System Requirements: WINDOWS^ 3.1 or higher, 386 processor or higher, 4 MB RAM for Windows 3.1 and 3.11, 8 MB RAM for Windows 95, 5 MB hard drive space

Part Number	Description	Std. Pkg. Qty.*
SEZ-PM	SAFETY EASE Marker and Tag Software	1

*Order number of programs required in multiples of Std. Pkg. Qty.



SAFETY EASE / DURA-MARK System:

Use your own computer and the PTR2 Printer with **SAFETY EASE** Software to produce vivid indoor/outdoor adhesive vinyl markers and signs

- Order supplies individually (see [pages 20-21](#)) or in kits shown below
- Sign blanks are shown below to convert adhesive markers to non-adhesive signs

SAFETY EASE Electrical Marker and Tag Kit

- To create tags and 2" high yellow and orange markers
- Part Number: SEZ-ELECKIT1

Supplies Included	Description	Qty.
PTR2	DURA-MARK Printer	1
SEZ-PM	SAFETY EASE Software	1
TTV2-YEL	2" x 100' Yellow Thermal Transfer Roll	1
TTV2-ORG	2" x 100' Orange Thermal Transfer Roll	1
TTR2-BL	2" Black Ribbon	1
PST-4	3.50" x 5.75" Self-laminating Tag with Nylon ties	25

Order number of kits required

SAFETY EASE Pipe Marker and Tag Kit

- To create tags and 2" high yellow and green markers
- Part Number: SEZ-PIPEKIT1

Supplies Included	Description	Qty.
PTR2	DURA-MARK Printer	1
SEZ-PM	SAFETY EASE Software	1
TTV2-YEL	2" x 100' Yellow Thermal Transfer Roll	1
TTV2-GRN	2" x 100' Orange Thermal Transfer Roll	1
TTR2-WH	2" White Ribbon	1
TTR2-BL	2" Black Ribbon	1
PST-4	3.50" x 5.75" Self-laminating Tag with Nylon ties	25

Order number of kits required

Sign Blanks

- Print legend on clear tape (see [page 21](#)) and adhere marker to any of the sign blanks shown



Header	Color (Legend/Background)	Size Height x Length In. (mm)	Polyester Film Self-Adhesive	Rigid Polyethylene Non-Adhesive
CAUTION	Black/Yellow	7 x 10 (178 x 254) 10 x 14 (254 x 356) 14 x 20 (256 x 508)	PPS0710C442 PPS1014C442 PPS1420C442	PRS0710C442 PRS1014C442 PRS1420C442
DANGER	Red and Black/White	7 x 10 (178 x 254) 10 x 14 (254 x 356) 14 x 20 (256 x 508)	PPS0710D440 PPS1014D440 PPS1420D440	PRS0710D440 PRS1014D440 PRS1420D440
NOTICE	Black and Blue/White	7 x 10 (178 x 254) 10 x 14 (254 x 356) 14 x 20 (256 x 508)	PPS0710N443 PPS1014N443 PPS1420N443	PRS0710N443 PRS1014N443 PRS1420N443
Blank Sign-No Header	White	7 x 10 (178 x 254) 10 x 14 (254 x 356) 14 x 20 (256 x 508)	PPS0710BWHT PPS1014BWHT PPS1420BWHT	PRS0710BWHT PRS1014BWHT PRS1420BWHT
Blank Sign-No Header	Yellow	7 x 10 (178 x 254) 10 x 14 (254 x 356) 14 x 20 (256 x 508)	PPS0710BYEL PPS1014BYEL PPS1420BYEL	PRS0710BYEL PRS1014BYEL PRS1420BYEL

Order number of signs required

SAFETY EASE™ Products (cont.)



SAFETY EASE / Laser or Ink Jet Printer System:

Use your own computer and laser or ink jet printer with **SAFETY EASE** Software to create indoor electrical markers, tags and pipe markers

- Create paper markers and tags on your printer
- Self-Laminating Adhesive carriers convert paper to adhesive indoor markers
- Safety Tag Carriers convert paper to rigid indoor tags
- Card Stock Tag sheets available to create temporary tags

Self-Laminating Indoor Polyester Adhesive Carriers

- Convert paper to adhesive indoor markers
- For clean and dry surfaces
- Cut out paper marker and insert into the self-laminating adhesive carrier

Part Numbers	For Maximum Marker Size W X L In. (mm)	Carriers/Pkg	Std. Pkg. Qty.*
SEZ-PMC.75	9.00 x 1.50 (228.6 x 38.1)	5	1 Pkg.
SEZ-PMC1	12.00 x 2.00 (304.8 x 50.8)		
SEZ-PMC2	16.00 x 3.00 (406.4 x 76.2)		
SEZ-PMC6	23.00 x 4.00 (584.2 x 101.6)		
SEZ-PMC8	32.00 x 9.00 (812.8 x 228.6)		

* Order number of Std. Pkg's required.

Indoor Rigid Vinyl Safety Tag Carriers for Laser and Ink Jet Printers

- Create your own rigid indoor tags with protected legends in minutes! Using the PST Tag carrier allows tags to be resistant to mild chemicals and acids. Sturdy brass grommet provides extra durability
- Panduit PLT2S (7.4") nylon ties included for quick and easy installation

Part Numbers	Description	Lamination	No. of Carriers and Ties/ Pkg.	Std. Pkg. Qty.*
PST-4	Tag Carriers with overlaminate	Front Side Only	25	1 Pkg.
PST-6			100	
PST-5		Front and Back Sides	25	
PST-7			100	

* Order number of Std. Pkg's required.



Print paper tag using a laser or ink-jet printer. Use scissors to cut out tag.



Place tag between self-adhesive laminate liner and rigid vinyl backing. Fasten tag with Panduit Cable Tie.

Economical Card Stock Tags for Ink Jet Printers

- Economical solution for temporary, indoor tags



Print sheet of tag stock using an ink-jet printer. Tear tags apart on perforation.

Part Numbers	Description	Color	Sheets/ Pkg.	Std. Pkg. Qty.*
SEZ-TAGWH	Perforated card stock, four blank tags per sheet	White	25	1 Pkg.
SEZ-TAGOR		Orange		
SEZ-TAGY		Yellow		
SEZ-TAGRD		Red		
SEZ-TAGGR		Green		
SEZ-TAGBU		Blue		

* Order number of Std. Pkg's required.



Panduit offers high quality thermal transfer labels in a variety of materials, sizes and styles.

Panduit Thermal Transfer Labels are used for a wide variety of identification purposes including wire marking, bar code labeling, and shipment tracking. Label materials are available that provide weather and chemical resistance and withstand temperature extremes and UV exposure. With a full range of sizes, there is a label available for every application. The need for large inventories of custom preprinted labels and long lead times is eliminated, providing an economical solution to all of your labeling needs.

All labels in this section are roll mounted on 3.00" (76.2 mm) cores.



Self-Laminating Thermal Transfer Labels

- These labels are used most commonly for marking wires, cables, test tubes and other cylindrical objects in applications where a protective overlamine is needed.



Specialized Blank Thermal Transfer Labels

- Panduit offers labels in a variety of high performance materials for a wide range of applications from labeling circuit boards to asset management to wire identification. These labels are designed for specific purposes and are available in five materials to meet your application requirements.



Heat Shrink Labels

- Durable, high quality permanent heat shrink markers for wire and cable identification.
- Available in white and yellow for wire diameters from 0.04" to 1.00".



Thermal Transfer Ribbons

- Designed specifically for outstanding images in harsh environments on a wide spectrum of materials.
- Available in two types:
 - Resin for harsh environments
 - Wax for self-laminating labels, heat shrink labels and general purpose labeling

Suggested Applications for Thermal Transfer Labels:



Circuit Board Labeling

Recommended Materials

Material	Color	Usage	Part Number Listing on Page
GMP4-W Paper	White	Indoor	37
GM4-C Polyester	Clear	Indoor / Outdoor	38
GM4-W Polyester	White	Indoor / Outdoor	38
GM4-S Polyester	Silver	Indoor / Outdoor	39
GM4-STE Tamper Evident Polyester	Silver	Indoor / Outdoor	39
GMPE4-W Destructible Polyethylene	White	Indoor	37



Rating Plate Labeling

Recommended Materials

Material	Color	Usage	Part Number Listing on Page
GMP4-W Paper	White	Indoor	37
GM4-C Polyester	Clear	Indoor / Outdoor	38
GM4-W Polyester	White	Indoor / Outdoor	38
GM4-S Polyester	Silver	Indoor / Outdoor	39
GM4-STE Tamper Evident Polyester	Silver	Indoor / Outdoor	39
GMPE4-W Destructible Polyethylene	White	Indoor	37



Laboratory and Health Care Labeling

Recommended Materials

Material	Color	Usage	Part Number Listing on Page
GMP4-W Paper	White	Indoor	37
GM4-C Polyester	Clear	Indoor / Outdoor	38
GM4-W Polyester	White	Indoor / Outdoor	38
GM4-STE Tamper Evident Polyester	Silver	Indoor / Outdoor	39
GMPE4-W Destructible Polyethylene	White	Indoor	37
GMV3 Self-Laminating Vinyl	White / Clear	Indoor	36



Asset Labeling

Recommended Materials

Material	Color	Usage	Part Number Listing on Page
GMP4-W Paper	White	Indoor	37
GM4-C Polyester	Clear	Indoor / Outdoor	38
GM4-W Polyester	White	Indoor / Outdoor	38
GM4-S Polyester	Silver	Indoor / Outdoor	39
GM4-STE Tamper Evident Polyester	Silver	Indoor / Outdoor	39

Suggested Applications for Thermal Transfer Labels:



Bar Code Labeling

Recommended Materials

Material	Color	Usage	Part Number Listing on Page
GMP4-W Paper	White	Indoor	37
GMV4-C Polyester	Clear	Indoor / Outdoor	38
GMV4-W Polyester	White	Indoor / Outdoor	38
GMV4-S Polyester	Silver	Indoor / Outdoor	39
GMV4-STE Tamper Evident Polyester	Silver	Indoor / Outdoor	39



Wire and Cable Identification

Recommended Materials

Material	Color	Usage	Part Number Listing on Page
GMV3 Self-Laminating Vinyl	White / Clear	Indoor	36
GMT4-W TEDLAR *	White	Indoor / Outdoor	39



Shipment Tracking

Recommended Materials

Material	Color	Usage	Part Number Listing on Page
GMP4-W Paper	White	Indoor	37
GMV4-W Polyester	White	Indoor / Outdoor	38



Network Systems Labeling

Recommended Materials

Material	Color	Usage	Part Number Listing on Page
GMV4-W Polyester	White	Indoor / Outdoor	40-41
GMV4-C Polyester	Clear	Indoor / Outdoor	41

*TEDLAR is the registered trademark of E. I. DuPont Co.

Thermal Transfer Material Selection Guide

Choose the material that best suits your application:

Material Code	Material Type	Temperature Range	Key Features	Color	Outdoor Rated	Hazardous Environment	UL Rec.	CSA
GMV3	Self-Laminating Vinyl Film	-40°F to 176°F (-40°C to 80°C)	General purpose vinyl self-laminating labels	Clear	No	No	Yes	Yes
GMP4-W	Destructible Paper	-65°F to 160°F (-54°C to 71°C)	Tamper resistant litho paper for permanent applications	White	No	No	No	No
GMPE4-W	Destructible Polyethylene	-40°F to 176°F (-40°C to 80°C)	Destructible adhesive for permanent applications	White	No	No	No	No
GMV4-C	Clear Polyester	-40°F to 302°F (-40°C to 150°C)	Durable; high temperature; does not stretch or easily tear	Clear	Yes	Yes	No	No
GMV4-W	White Polyester	-40°F to 302°F (-40°C to 150°C)	Durable; high temperature; does not stretch or easily tear	White	Yes	Yes	No	No
GMV4-S	Metallized Polyester	-40°F to 302°F (-40°C to 150°C)	Durable; high temperature; does not stretch or easily tear; protects data EPROM by blocking out light	Silver	Yes	Yes	No	No
GMV4-STE	Tamper Evident Polyester	-40°F to 104°F (-40°C to 40°C)	Destructible material; label cannot be completely removed once applied	Silver	Yes	No	No	No
GMT4-W	TEDLAR *	-40°F to 225°F (-40°C to 106°C)	Indoor/outdoor high temperature labels; Self-extinguishing	White	Yes	Yes	No	No

*TEDLAR is the registered trademark of E. I. DuPont Co.

Self-Laminating Thermal Transfer Labels

GMV3 Self-Laminating Vinyl — Indoor Applications

Suggested Uses

- Laboratory and Health Care
- Wire and Cable Identification

Key Features

- General purpose self-laminating labels

Part Number	Material	Print-On Area Color	Label Size Width x Length In. (mm)	Print-On Area Width x Length In. (mm)	Nominal Cable Outside Diameter * In. (mm)	Dwg. Page No.	Std. Pkg. Qty.*
TTSL8VC3-10	GMV3 Self-Laminating Vinyl	White	0.50 x 0.75 (12.7 x 19.1)	0.50 x 0.41 (12.7 x 10.4)	0.10 (2.5)	44	10,000
TTSL1VC3-10			0.50 x 1.50 (12.7 x 38.1)	0.50 x 0.50 (12.7 x 12.7)	0.16 - 0.32 (4.1 - 8.1)	44	10,000
TTSL10VC3-5			0.50 x 2.00 (12.7 x 50.8)	0.50 x 1.00 (12.7 x 25.4)	0.32 (8.1)	44	5000
TTSL247VC3-10			0.80 x 0.94 (20.3 x 23.9)	0.80 x 0.38 (20.3 x 9.6)	0.12 - 0.18 (3.0 - 4.6)	44	10,000
TTSL9VC3-10			1.00 x 0.75 (25.4 x 19.1)	1.00 x 0.38 (25.4 x 9.6)	0.12 (3.0)	44	10,000
TTSL250VC3-2.5			1.00 x 0.94 (25.4 x 23.9)	1.00 x 0.38 (25.4 x 9.6)	0.12 - 0.18 (3.0 - 4.5)	44	2500
TTSL2VC3-10			1.00 x 1.50 (25.4 x 38.1)	1.00 x 0.50 (25.4 x 12.7)	0.16 - 0.32 (4.1 - 8.1)	44	10,000
TTSL4VC3-5			1.00 x 2.44 (25.4 x 62.0)	1.00 x 1.00 (25.4 x 25.4)	0.32 - 0.46 (8.1 - 11.6)	44	5000
TTSL6VC3-2.5			1.00 x 3.94 (25.4 x 100.1)	1.00 x 1.00 (25.4 x 25.4)	0.32 - 0.94 (8.1 - 23.8)	44	2500
TTSL3VC3-1			2.00 x 1.50 (50.8 x 38.1)	2.00 x 0.50 (50.8 x 12.7)	0.16 - 0.32 (4.1 - 8.1)	44	1000
TTSL7VC3-1			2.00 x 3.94 (50.8 x 100.1)	2.00 x 1.00 (50.8 x 25.4)	0.32 - 0.94 (8.1 - 23.8)	44	1000

*Order number of labels required in multiples of Std. Pkg. Qty.

*Refer to Wire Size Selection Guide on page 196 to review diameters of commonly used cables

Blank Thermal Transfer Labels by Material

GMP4-W Paper — Indoor Applications

Key Features

- Tamper resistant litho paper for permanent applications

Suggested Uses

- Rating Plates
- Laboratory and Health Care
- Asset Identification
- Bar Code Labels
- Shipment Tracking
- Hazardous Material Identification

Part Number	Material	Color	Label Size Width x Length In (mm)	Dwg. Page No.	Std. Pkg. Qty.*
TTC15P-2.5	GMP4-W Paper	White	1.50 x 1.00 (38.1 x 25.4)	42	2500
TTC20P-2.5			2.00 x 1.00 (50.8 x 25.4)	42	2500
TTC21P-2.5			2.00 x 1.25 (50.8 x 31.8)	42	2500
TTC22P-2.5			2.75 x 1.25 (69.9 x 31.8)	43	2500
TTC46P-5			3.00 x 0.94 (76.2 x 23.8)	43	5000
TTC24P-2.5			3.00 x 1.00 (76.2 x 25.4)	43	2500
TTC25P-1			3.00 x 2.00 (76.2 x 50.8)	43	1000
TTC26P-1			3.00 x 5.00 (76.2 x 127.0)	43	1000
TTC31P-1			3.50 x 1.00 (88.9 x 25.4)	43	1000
TTC32P-1			3.50 x 8.00 (88.9 x 203.2)	43	1000
TTC34P-5			3.63 x 4.2 (92.1 x 107.1)	43	500
TTC33P-5			3.63 x 5.79 (92.1 x 147.1)	43	500
TTC35P-2.5			4.00 x 1.00 (101.6 x 25.4)	43	2500
TTC36P-1			4.00 x 2.00 (101.6 x 50.8)	43	1000
TTC37P-1			4.00 x 3.00 (101.6 x 76.2)	43	1000
TTC38P-1			4.00 x 4.00 (101.6 x 101.6)	43	1000
TTC39P-1			4.00 x 5.00 (101.6 x 127.0)	43	1000
TTC40P-1			4.00 x 6.00 (101.6 x 152.4)	43	1000
TTC41P-1			4.00 x 6.50 (101.6 x 165.1)	43	1000
TTC42P-5			4.00 x 12.88 (101.6 x 327.0)	43	500
TTC43P-1	5.00 x 4.00 (127.0 x 101.6)	44	1000		
TTC44P-1	6.00 x 4.00 (152.4 x 101.6)	44	1000		

GMPE4-W Destructible Polyethylene — Indoor Applications

Key Features

- Tamper evident

Suggested Uses

- Circuit Board Labeling
- Rating Plates
- Laboratory and Health Care

Part Number	Material	Color	Label Size Width x Length In (mm)	Dwg. Page No.	Std. Pkg. Qty.*
TTC8ET-10	GMPE4-W Destructible Polyethylene	White	1.00 x 0.50 (25.4 x 12.7)	42	10,000

*Order number of labels required in multiples of Std. Pkg. Qty.

Blank Thermal Transfer Labels by Material (cont.)

GMY4-C Clear Polyester — Indoor/Outdoor Applications

Key Features

- Durable
- High temperature
- Does not stretch or easily tear

Suggested Uses

- Circuit Board Labeling
- Rating Plates
- Asset Identification
- Bar Code Labels

Part Number	Material	Color	Label Size Width x Length In (mm)	Dwg. Page No.	Std. Pkg. Qty.*
TTC8YC-10	GMY4-C Polyester	Clear	1.00 x 0.50 (25.4 x 12.7)	42	10,000
TTC20YC-2.5			2.00 x 1.00 (50.8 x 25.4)	42	2500
TTC24YC-2.5			3.00 x 1.00 (76.2 x 25.4)	43	2500
TTC25YC-1			3.00 x 2.00 (76.2 x 50.8)	43	1000

GMY4-W White Polyester — Indoor/Outdoor Applications

Key Features

- Durable
- High temperature
- Does not stretch or easily tear

Suggested Uses

- Circuit Board Labeling
- Rating Plates
- Laboratory and Health Care
- Asset Identification
- Bar Code Labels
- Shipment Tracking
- Hazardous Material Identification

Part Number	Material	Color	Label Size Width x Length In (mm)	Dwg. Page No.	Std. Pkg. Qty.*
TTC1Y-10	GMY4-W Polyester	White	0.25 x 0.25 (6.4 x 6.4)	42	10,000
TTC2Y-10			0.38 x 0.38 (9.5 x 9.5)	42	10,000
TTC3Y-10			0.50 x 0.44 (12.7 x 11.1)	42	10,000
TTC45Y-1			0.50 x 0.75 (12.7 x 19.1)	42	1000
TTC4Y-10			0.65 x 0.20 (16.5 x 5.1)	42	10,000
TTC5Y-10			0.75 x 0.25 (19.1 x 6.4)	42	10,000
TTC6Y-10			0.90 x 0.25 (22.9 x 6.4)	42	10,000
TTC7Y-10			1.00 x 0.38 (25.4 x 9.5)	42	10,000
TTC8Y-10			1.00 x 0.50 (25.4 x 12.7)	42	10,000
TTC9Y-10			1.25 x 0.25 (31.8 x 6.4)	42	10,000
TTC10Y-10			1.25 x 0.38 (31.8 x 9.5)	42	10,000
TTC11Y-10			1.50 x 0.25 (38.1 x 6.4)	42	10,000
TTC12Y-10			1.50 x 0.50 (38.1 x 12.7)	42	10,000
TTC13Y-10			1.50 x 0.75 (38.1 x 19.1)	42	10,000
TTC14Y-2.5			1.50 x 0.81 (38.1 x 20.6)	42	2500
TTC15Y-2.5			1.50 x 1.00 (38.1 x 25.4)	42	2500
TTC16Y-2.5			1.50 x 1.13 (38.1 x 28.6)	42	2500
TTC17Y-2.5			1.63 x 1.25 (41.3 x 31.8)	42	2500
TTC18Y-2.5			2.00 x 0.25 (50.8 x 6.4)	42	2500
TTC19Y-2.5			2.00 x 0.50 (50.8 x 12.7)	42	2500
TTC20Y-2.5			2.00 x 1.00 (50.8 x 25.4)	42	2500
TTC22Y-2.5			2.75 x 1.25 (69.9 x 31.8)	43	2500
TTC23Y-2.5			3.00 x 0.25 (76.2 x 6.4)	43	2500
TTC24Y-2.5			3.00 x 1.00 (76.2 x 25.4)	43	2500
TTC25Y-1			3.00 x 2.00 (76.2 x 50.8)	43	1000
TTC27Y-10			3.25 x 0.31 (82.6 x 7.92)	43	10,000
TTC28Y-10			3.25 x 0.50 (82.6 x 12.7)	43	10,000
TTC29Y-5			3.25 x 0.63 (82.6 x 15.9)	43	5000
TTC30Y-2.5			3.25 x 0.81 (82.6 x 20.6)	43	2500
TTC31Y-1			3.50 x 1.00 (88.9 x 25.4)	43	1000
TTC32Y-1			3.50 x 8.00 (88.9 x 203.2)	43	1000
TTC35Y-2.5			4.00 x 1.00 (101.6 x 25.4)	43	2500
TTC36Y-1			4.00 x 2.00 (101.6 x 50.8)	43	1000
TTC37Y-1			4.00 x 3.00 (101.6 x 76.2)	43	1000
TTC38Y-1			4.00 x 4.00 (101.6 x 101.6)	43	1000
TTC39Y-1			4.00 x 5.00 (101.6 x 127.0)	43	1000
TTC41Y-1			4.00 x 6.50 (101.6 x 165.1)	43	1000
TTC42Y-5			4.00 x 12.88 (101.6 x 327.0)	43	500
TTC43Y-1			5.00 x 4.00 (127.0 x 101.6)	44	1000
TTC44Y-1			6.00 x 4.00 (152.4 x 101.6)	44	1000

Thermal Transfer Labels

Blank Thermal Transfer Labels by Material (cont.)

GM4-S Silver Polyester — Indoor/Outdoor Applications

Key Features

- Durable
- High temperature
- Does not stretch or easily tear
- Protects data EPROM by blocking out light

Suggested Uses

- Circuit Board Labeling
- Rating Plates
- Asset Identification
- Bar Code Labels

Part Number	Material	Color	Label Size Width x Length In (mm)	Dwg. Page No.	Std. Pkg. Qty.*
TTC3YS-10	GM4-S Polyester	Silver	0.50 x 0.44 (12.7 x 11.1)	42	10,000
TTC5YS-10			0.75 x 0.25 (19.1 x 6.4)	42	10,000
TTC7YS-10			1.00 x 0.38 (25.4 x 9.5)	42	10,000
TTC8YS-10			1.00 x 0.50 (25.4 x 12.7)	42	10,000
TTC13YS-10			1.50 x 0.75 (38.1 x 19.1)	42	10,000
TTC20YS-2.5			2.00 x 1.00 (50.8 x 25.4)	42	2500
TTC22YS-2.5			2.75 x 1.25 (69.9 x 31.8)	43	2500
TTC24YS-2.5			3.00 x 1.00 (76.2 x 25.4)	43	2500
TTC25YS-1			3.00 x 2.00 (76.2 x 50.8)	43	1000
TTC36YS-1			4.00 x 2.00 (101.6 x 50.8)	43	1000

GM4-STE Tamper Evident Polyester — Indoor/Outdoor Applications

Key Features

- Tamper evident

Suggested Uses

- Circuit Board Labeling
- Rating Plates
- Laboratory and Health Care
- Asset Identification

Part Number	Material	Color	Label Size Width x Length In (mm)	Dwg. Page No.	Std. Pkg. Qty.*
TTC3YST-10	GM4-STE Tamper Evident Polyester	Silver	0.50 x 0.44 (12.7 x 11.1)	42	10,000
TTC4YST-10			0.65 x 0.20 (16.5 x 5.1)	42	10,000
TTC5YST-10			0.75 x 0.25 (19.1 x 6.4)	42	10,000
TTC8YST-10			1.00 x 0.50 (25.4 x 12.7)	42	10,000
TTC20YST-2.5			2.00 x 1.00 (50.8 x 25.4)	42	2500
TTC24YST-2.5			3.00 x 1.00 (76.2 x 25.4)	43	2500
TTC25YST-1			3.00 x 2.00 (76.2 x 50.8)	43	1000

GMT4-W TEDLAR ^ — Indoor/Outdoor Applications

Key Features

- High temperature
- Self-extinguishing

Suggested Uses

- Wire and Cable Identification
- Outdoor Applications

Part Number	Material	Color	Label Size Width x Length In (mm)	Dwg. Page No.	Std. Pkg. Qty.*
TTC4T-10	GMT4-W TEDLAR ^	White	0.65 x 0.20 (16.5 x 5.1)	42	10,000
TTC5T-10			0.75 x 0.25 (19.1 x 6.4)	42	10,000
TTC6T-10			0.90 x 0.25 (22.9 x 6.4)	42	10,000
TTC8T-10			1.00 x 0.50 (25.4 x 12.7)	42	10,000
TTC10T-10			1.25 x 0.38 (31.8 x 9.5)	42	10,000

^TEDLAR is the registered trademark of E. I. DuPont Co.

TIA/EIA-606 Compliant Network Systems Labeling



What is TIA/EIA-606?

TIA/EIA-606 is a standard from the Telecommunications Industry Association which requires labeling and administration of the telecommunication infrastructure in commercial buildings. TIA-606 applies to Cables, Connectors, Hub Facilities, Termination Facilities (Patch Panels), Conduits and Pathways.

Panduit manufactures a broad range of labeling products to help you conform to TIA/EIA-606.

Along with the labels already shown in this section, the following pages feature labels designed specifically for Network Systems Labeling.

*For more information on the complete line of **PAN-NET™** Network Cabling System Products, ask for the Communication Products Catalog.*

Termination Hardware Labeling



Adhesive 110 Punchdown Block Labels

- Eliminate the need for standard paper designation strips
- Labels are placed on top of label holders

Part Number	Material	Color	Label Width In. (mm)	Label Length In. (mm)	Horizontal Repeat In. (mm)	Vertical Repeat In. (mm)	Labels Per Row	Web Width In. (mm)	Std. Pkg. Qty.*
TTC-DS110-5	GMY4-W Polyester	White	0.50 (12.7)	7.88 (200.0)	—	8.13 (206.4)	1	1.25 (31.8)	500

*Order number of labels required in multiples of Std. Pkg. Qty.



Adhesive Label for Patch Panels and Modular Furniture Faceplates

- Label is perforated on black lines to be used in 2 position, 4 position, or 6 position applications

Part Number	Material	Color	Label Width In. (mm)	Label Length In. (mm)	Horizontal Repeat In. (mm)	Vertical Repeat In. (mm)	Labels Per Row	Web Width In. (mm)	Std. Pkg. Qty.*
TTC-CPL-1	GMY4-W Polyester	White	0.33 (8.4)	0.61 (15.5)	0.33 (8.4)	0.61 (15.5)	1	1.25 (31.8)	1000

*Order number of labels required in multiples of Std. Pkg. Qty.

Network Systems Labeling — Termination Position Labeling



MINI-JACK™ Modular Jack and **OPTI-JACK™** Fiber Optic Connector Labels

- Identify individual jacks and connectors
- Wrap around design allows for quick and secure installation
- Labels attach directly to jacks

Part Number	Material	Color	Label Width In. (mm)	Label Length In. (mm)	Horizontal Repeat In. (mm)	Vertical Repeat In. (mm)	Labels Per Row	Web Width In. (mm)	Std. Pkg. Qty.*
TTC-MJ-5	GMY4 Polyester	Clear	1.38 (34.9)	0.19 (4.8)	—	0.38 (9.5)	1	2.25 (57.2)	5000
TTC-MJWH-5		White							

*Order number of labels required in multiples of Std. Pkg. Qty.



Faceplate Adhesive Labels

- For use with **MINI-COM®** Executive and Designer Series Faceplates
- Designed to fit on vinyl insert provided with faceplate
- Single and Double Gang versions available
- Can also be used to identify **MINI-COM** Surface Mount Boxes

Part Number	Faceplate Type	Material	Color	Label Width In. (mm)	Label Length In. (mm)	Horizontal Repeat In. (mm)	Vertical Repeat In. (mm)	Labels Per Row	Web Width In. (mm)	Std. Pkg. Qty.*
TTC-EFPL-1	Single Gang	GMY4-W Polyester	White	1.80 (45.7)	0.38 (9.5)	—	0.63 (15.9)	1	2.25 (57.2)	1000
TTC-EFPLC-1			Clear							
TTC-EFPL10-1	Double Gang		White	2.90 (73.7)	0.30 (7.6)	—	0.55 (14.0)	1	3.25 (82.6)	1000

*Order number of labels required in multiples of Std. Pkg. Qty.

For more information on the complete line of **PAN-NET™** Network Cabling System Products, ask for the Communication Products Catalog.

Blank Thermal Transfer Labels by Size



Part Number	Material	Color	Label Width A In. (mm)	Label Length B In. (mm)	Horizontal Repeat D In. (mm)	Vertical Repeat E In. (mm)	Labels Per Row	Web Width F In. (mm)	Std. Pkg. Qty.*
TTC1Y-10	Polyester	White	0.25 (6.4)	0.25 (6.4)	0.25 (6.4)	0.38 (9.5)	12	3.20 (81.3)	10,000
TTC-CPL-1	Polyester	White	0.33 (8.4)	0.61 (15.5)	0.33 (8.4)	0.61 (15.5)	1	1.25 (31.8)	1000
TTC2Y-10	Polyester	White	0.38 (9.5)	0.38 (9.5)	0.44 (11.1)	0.48 (12.1)	7	3.20 (81.3)	10,000
TTC3YS-10	Polyester	Silver	0.50 (12.7)	0.44 (11.1)	0.66 (16.8)	0.48 (12.1)	5	3.35 (85.1)	10,000
TTC3Y-10	Polyester	White	0.50 (12.7)	0.44 (11.1)	0.66 (16.8)	0.48 (12.1)	5	3.35 (85.1)	10,000
TTC3YST-10	Tamper Evident Polyester	Silver	0.50 (12.7)	0.44 (11.1)	0.66 (16.8)	0.48 (12.1)	5	3.35 (85.1)	10,000
TTC45Y-1	Polyester	White	0.50 (12.7)	0.75 (19.1)	0.50 (12.7)	0.88 (22.2)	1	4.25 (108.0)	1000
TTC-DS110-.5	Polyester	White	0.50 (12.7)	7.88 (200.0)	—	8.13 (206.4)	1	1.25 (31.8)	500
TTC4Y-10	Polyester	White	0.65 (16.5)	0.20 (5.1)	0.70 (17.8)	0.28 (7.0)	4	2.95 (74.9)	10,000
TTC4YST-10	Tamper Evident Polyester	Silver	0.65 (16.5)	0.20 (5.1)	0.70 (17.8)	0.28 (7.0)	4	2.95 (74.9)	10,000
TTC4T-10	TEDLAR [▲]	White	0.65 (16.5)	0.20 (5.1)	0.70 (17.8)	0.28 (7.0)	4	2.95 (74.9)	10,000
TTC5YS-10	Polyester	Silver	0.75 (19.1)	0.25 (6.4)	0.80 (20.3)	0.35 (8.9)	4	3.35 (85.1)	10,000
TTC5Y-10	Polyester	White	0.75 (19.1)	0.25 (6.4)	0.80 (20.3)	0.35 (8.9)	4	3.35 (85.1)	10,000
TTC5YST-10	Tamper Evident Polyester	Silver	0.75 (19.1)	0.25 (6.4)	0.80 (20.3)	0.35 (8.9)	4	3.35 (85.1)	10,000
TTC5T-10	TEDLAR	White	0.75 (19.1)	0.25 (6.4)	0.80 (20.3)	0.35 (8.9)	4	3.35 (85.1)	10,000
TTC6Y-10	Polyester	White	0.90 (22.9)	0.25 (6.4)	1.13 (28.6)	0.35 (8.9)	3	3.35 (85.1)	10,000
TTC6T-10	TEDLAR	White	0.90 (22.9)	0.25 (6.4)	1.13 (28.6)	0.35 (8.9)	3	3.35 (85.1)	10,000
TTC7YS-10	Polyester	Silver	1.00 (25.4)	0.38 (9.5)	1.08 (27.3)	0.48 (12.1)	3	3.35 (85.1)	10,000
TTC7Y-10	Polyester	White	1.00 (25.4)	0.38 (9.5)	1.08 (27.3)	0.48 (12.1)	3	3.35 (85.1)	10,000
TTC8ET-10	Destructible Polyethylene	White	1.00 (25.4)	0.50 (12.7)	1.08 (27.3)	0.60 (15.2)	3	3.35 (85.1)	10,000
TTC8YS-10	Polyester	Silver	1.00 (25.4)	0.50 (12.7)	1.08 (27.3)	0.60 (15.2)	3	3.35 (85.1)	10,000
TTC8YC-10	Polyester	Clear	1.00 (25.4)	0.50 (12.7)	1.08 (27.3)	0.63 (15.9)	3	3.35 (85.1)	10,000
TTC8Y-10	Polyester	White	1.00 (25.4)	0.50 (12.7)	1.08 (27.3)	0.60 (15.2)	3	3.35 (85.1)	10,000
TTC8YST-10	Tamper Evident Polyester	Silver	1.00 (25.4)	0.50 (12.7)	1.08 (27.3)	0.60 (15.2)	3	3.35 (85.1)	10,000
TTC8T-10	TEDLAR	White	1.00 (25.4)	0.50 (12.7)	1.08 (27.3)	0.60 (15.2)	3	3.35 (85.1)	10,000
TTC9Y-10	Polyester	White	1.25 (31.8)	0.25 (6.4)	1.30 (33.0)	0.38 (9.5)	2	2.75 (69.9)	10,000
TTC10Y-10	Polyester	White	1.25 (31.8)	0.38 (9.5)	1.30 (33.0)	0.48 (12.1)	2	2.75 (69.9)	10,000
TTC10T-10	TEDLAR	White	1.25 (31.8)	0.38 (9.5)	1.30 (33.0)	0.48 (12.1)	2	2.75 (69.9)	10,000
TTC-MJ-5	Polyester	Clear	1.38 (34.9)	0.19 (4.8)	—	0.38 (9.5)	1	2.25 (57.2)	5000
TTC-MJWH-5	Polyester	White	1.38 (34.9)	0.19 (4.8)	—	0.38 (9.5)	1	2.25 (57.2)	5000
TTC11Y-10	Polyester	White	1.50 (38.1)	0.25 (6.4)	1.65 (41.9)	0.35 (8.9)	2	3.35 (85.1)	10,000
TTC12Y-10	Polyester	White	1.50 (38.1)	0.50 (12.7)	1.65 (41.9)	0.63 (15.9)	2	3.35 (85.1)	10,000
TTC13YS-10	Polyester	Silver	1.50 (38.1)	0.75 (19.1)	1.65 (41.9)	0.88 (22.2)	2	3.35 (85.1)	10,000
TTC13Y-10	Polyester	White	1.50 (38.1)	0.75 (19.1)	1.65 (41.9)	0.88 (22.2)	2	3.35 (85.1)	10,000
TTC14Y-2.5	Polyester	White	1.50 (38.1)	0.81 (20.6)	1.65 (41.9)	0.94 (23.8)	2	3.35 (85.1)	2500
TTC15P-2.5	Paper	White	1.50 (38.1)	1.00 (25.4)	—	1.63 (41.3)	1	1.75 (44.5)	2500
TTC15Y-2.5	Polyester	White	1.50 (38.1)	1.00 (25.4)	—	1.63 (41.3)	1	1.75 (44.5)	2500
TTC16Y-2.5	Polyester	White	1.50 (38.1)	1.13 (28.6)	1.65 (41.9)	1.25 (31.8)	2	3.35 (85.1)	2500
TTC17Y-2.5	Polyester	White	1.63 (41.3)	1.25 (31.8)	—	1.38 (34.9)	1	2.20 (55.9)	2500
TTC-EFPLC-1	Polyester	Clear	1.80 (45.7)	0.38 (9.5)	—	0.63 (15.9)	1	2.25 (57.2)	1000
TTC-EFPL-1	Polyester	White	1.80 (45.7)	0.38 (9.5)	—	0.63 (15.9)	1	2.25 (57.2)	1000
TTC18Y-2.5	Polyester	White	2.00 (50.8)	0.25 (6.4)	—	0.38 (9.5)	1	2.20 (55.9)	2500
TTC19Y-2.5	Polyester	White	2.00 (50.8)	0.50 (12.7)	—	0.60 (15.2)	1	2.20 (55.9)	2500
TTC20YS-2.5	Polyester	Silver	2.00 (50.8)	1.00 (25.4)	—	1.13 (28.6)	1	2.20 (55.9)	2500
TTC20P-2.5	Paper	White	2.00 (50.8)	1.00 (25.4)	—	1.13 (28.6)	1	2.20 (55.9)	2500
TTC20YC-2.5	Polyester	Clear	2.00 (50.8)	1.00 (25.4)	—	1.13 (28.6)	1	2.20 (55.9)	2500
TTC20Y-2.5	Polyester	White	2.00 (50.8)	1.00 (25.4)	—	1.13 (28.6)	1	2.20 (55.9)	2500
TTC20YST-2.5	Tamper Evident Polyester	Silver	2.00 (50.8)	1.00 (25.4)	—	1.13 (28.6)	1	2.20 (55.9)	2500
TTC21P-2.5	Paper	White	2.00 (50.8)	1.25 (31.8)	—	1.38 (34.9)	1	2.20 (55.9)	2500

Thermal Transfer Labels

Blank Thermal Transfer Labels by Size (cont.)



Part Number	Material	Color	Label Width A In. (mm)	Label Length B In. (mm)	Horizontal Repeat D In. (mm)	Vertical Repeat E In. (mm)	Labels Per Row	Web Width F In. (mm)	Std. Pkg. Qty.*
TTC22YS-2.5	Polyester	Silver	2.75 (69.9)	1.25 (31.8)	—	1.38 (34.9)	1	2.95 (74.9)	2500
TTC22P-2.5	Paper	White	2.75 (69.9)	1.25 (31.8)	—	1.38 (34.9)	1	2.95 (74.9)	2500
TTC22Y-2.5	Polyester	White	2.75 (69.9)	1.25 (31.8)	—	1.38 (34.9)	1	2.95 (74.9)	2500
TTC-EFPL10-1	Polyester	White	2.90 (73.7)	0.30 (7.6)	—	0.55 (14.0)	1	3.25 (82.6)	1000
TTC23Y-2.5	Polyester	White	3.00 (76.2)	0.25 (6.4)	—	0.38 (9.5)	1	3.20 (81.3)	2500
TTC46P-5	Paper	White	3.00 (76.2)	0.94 (23.8)	—	1.06 (27.0)	1	3.35 (85.1)	5000
TTC24YS-2.5	Polyester	Silver	3.00 (76.2)	1.00 (25.4)	—	1.13 (28.6)	1	3.20 (81.3)	2500
TTC24P-2.5	Paper	White	3.00 (76.2)	1.00 (25.4)	—	1.13 (28.6)	1	3.20 (81.3)	2500
TTC24YC-2.5	Polyester	Clear	3.00 (76.2)	1.00 (25.4)	—	1.13 (28.6)	1	3.20 (81.3)	2500
TTC24Y-2.5	Polyester	White	3.00 (76.2)	1.00 (25.4)	—	1.13 (28.6)	1	3.20 (81.3)	2500
TTC24YST-2.5	Tamper Evident Polyester	Silver	3.00 (76.2)	1.00 (25.4)	—	1.13 (28.6)	1	3.20 (81.3)	2500
TTC25YS-1	Polyester	Silver	3.00 (76.2)	2.00 (50.8)	—	2.13 (54.0)	1	3.20 (81.3)	1000
TTC25P-1	Paper	White	3.00 (76.2)	2.00 (50.8)	—	2.13 (54.0)	1	3.20 (81.3)	1000
TTC25YC-1	Polyester	Clear	3.00 (76.2)	2.00 (50.8)	—	2.13 (54.0)	1	3.20 (81.3)	1000
TTC25Y-1	Polyester	White	3.00 (76.2)	2.00 (50.8)	—	2.13 (54.0)	1	3.20 (81.3)	1000
TTC25YST-1	Tamper Evident Polyester	Silver	3.00 (76.2)	2.00 (50.8)	—	2.13 (54.0)	1	3.20 (81.3)	1000
TTC26P-1	Paper	White	3.00 (76.2)	5.00 (127.0)	—	5.13 (130.2)	1	3.20 (81.3)	1000
TTC27Y-10	Polyester	White	3.25 (82.6)	0.31 (7.9)	—	0.44 (11.1)	1	4.20 (106.7)	10,000
TTC28Y-10	Polyester	White	3.25 (82.6)	0.50 (12.7)	—	0.63 (15.9)	1	4.20 (106.7)	10,000
TTC29Y-5	Polyester	White	3.25 (82.6)	0.63 (15.9)	—	0.75 (19.1)	1	4.20 (106.7)	5000
TTC30Y-2.5	Polyester	White	3.25 (82.6)	0.81 (20.6)	—	0.94 (23.8)	1	4.20 (106.7)	2500
TTC31P-1	Paper	White	3.50 (88.9)	1.00 (25.4)	—	1.13 (28.6)	1	3.75 (95.3)	1000
TTC31Y-1	Polyester	White	3.50 (88.9)	1.00 (25.4)	—	1.13 (28.6)	1	3.75 (95.3)	1000
TTC32P-1	Paper	White	3.50 (88.9)	8.00 (203.2)	—	8.13 (206.4)	1	3.75 (95.3)	1000
TTC32Y-1	Polyester	White	3.50 (88.9)	8.00 (203.2)	—	8.13 (206.4)	1	3.75 (95.3)	1000
TTC34P-.5	Paper	White	3.63 (92.1)	4.20 (107.1)	—	4.34 (110.3)	1	4.20 (106.7)	500
TTC33P-.5	Paper	White	3.63 (92.1)	5.79 (147.1)	—	5.92 (150.3)	1	4.20 (106.7)	500
TTC35P-2.5	Paper	White	4.00 (101.6)	1.00 (25.4)	—	4.13 (104.8)	1	4.20 (106.7)	2500
TTC35Y-2.5	Polyester	White	4.00 (101.6)	1.00 (25.4)	—	4.13 (104.8)	1	4.20 (106.7)	2500
TTC36YS-1	Polyester	Silver	4.00 (101.6)	2.00 (50.8)	—	2.13 (54.0)	1	4.20 (106.7)	1000
TTC36P-1	Paper	White	4.00 (101.6)	2.00 (50.8)	—	2.13 (54.0)	1	4.20 (106.7)	1000
TTC36Y-1	Polyester	White	4.00 (101.6)	2.00 (50.8)	—	2.13 (54.0)	1	4.20 (106.7)	1000
TTC37P-1	Paper	White	4.00 (101.6)	3.00 (76.2)	—	3.13 (79.4)	1	4.20 (106.7)	1000
TTC37Y-1	Polyester	White	4.00 (101.6)	3.00 (76.2)	—	3.13 (79.4)	1	4.20 (106.7)	1000
TTC38P-1	Paper	White	4.00 (101.6)	4.00 (101.6)	—	4.13 (104.8)	1	4.20 (106.7)	1000
TTC38Y-1	Polyester	White	4.00 (101.6)	4.00 (101.6)	—	4.13 (104.8)	1	4.20 (106.7)	1000
TTC39P-1	Paper	White	4.00 (101.6)	5.00 (127.0)	—	5.13 (130.2)	1	4.20 (106.7)	1000
TTC39Y-1	Polyester	White	4.00 (101.6)	5.00 (127.0)	—	5.13 (130.2)	1	4.20 (106.7)	1000
TTC40P-1	Paper	White	4.00 (101.6)	6.00 (152.4)	—	6.06 (154.0)	1	4.20 (106.7)	1000
TTC41P-1	Paper	White	4.00 (101.6)	6.50 (165.1)	—	6.63 (168.3)	1	4.20 (106.7)	1000
TTC41Y-1	Polyester	White	4.00 (101.6)	6.50 (165.1)	—	6.63 (168.3)	1	4.20 (106.7)	1000
TTC42P-.5	Paper	White	4.00 (101.6)	12.88 (327.0)	—	13.00 (330.2)	1	4.20 (106.7)	500
TTC42Y-.5	Polyester	White	4.00 (101.6)	12.88 (327.0)	—	13.00 (330.2)	1	4.20 (106.7)	500

Labels are roll mounted on 3.00" (76.2 mm) core.
*Order number of labels required in multiples of Std. Pkg. Qty.

Blank Thermal Transfer Labels by Size (cont.)



Part Number	Material	Color	Label Width A In. (mm)	Label Length B In. (mm)	Horizontal Repeat D In. (mm)	Vertical Repeat E In. (mm)	Labels Per Row	Web Width F In. (mm)	Std. Pkg. Qty.*
TTC43P-1	Paper	White	5.00 (127.0)	4.00 (101.6)	—	4.13 (104.8)	1	5.20 (132.1)	1000
TTC43Y-1	Polyester	White	5.00 (127.0)	4.00 (101.6)	—	4.13 (104.8)	1	5.20 (132.1)	1000
TTC44P-1	Paper	White	6.00 (152.4)	4.00 (101.6)	—	4.13 (104.8)	1	6.20 (157.5)	1000
TTC44Y-1	Polyester	White	6.00 (152.4)	4.00 (101.6)	—	4.13 (104.8)	1	6.20 (157.5)	1000

Self-Laminating Thermal Transfer Labels by Size



Part Number	Material	Print-On Area Color	Label Width A In. (mm)	Label Length B In. (mm)	Print-On Length C In. (mm)	Horizontal Repeat D In. (mm)	Vertical Repeat E In. (mm)	Labels Per Row	Web Width F In. (mm)	Std. Pkg. Qty.*
TTSL8VC3-10	GMV3 SL	White	0.50 (12.7)	0.75 (19.1)	0.41 (10.4)	0.50 (12.7)	0.88 (22.2)	8	4.25 (108.0)	10,000
TTSL1VC3-10	GMV3 SL	White	0.50 (12.7)	1.50 (38.1)	0.50 (12.7)	0.50 (12.7)	1.80 (45.7)	8	4.25 (108.0)	10,000
TTSL10VC3-5	GMV3 SL	White	0.50 (12.7)	2.00 (50.8)	1.00 (25.4)	0.50 (12.7)	2.13 (54.0)	4	4.25 (108.0)	5000
TTSL247VC3-10	GMV3 SL	White	0.80 (20.3)	0.94 (23.9)	0.38 (9.6)	0.80 (20.3)	1.25 (31.8)	5	4.25 (108.0)	10,000
TTSL9VC3-10	GMV3 SL	White	1.00 (25.4)	0.75 (19.1)	0.35 (8.9)	1.00 (25.4)	0.88 (22.2)	4	4.25 (108.0)	10,000
TTSL250VC3-2.5	GMV3 SL	White	1.00 (25.4)	0.94 (23.9)	0.38 (9.6)	1.00 (25.4)	1.25 (31.8)	4	4.25 (108.0)	2500
TTSL2VC3-10	GMV3 SL	White	1.00 (25.4)	1.50 (38.1)	0.50 (12.7)	1.00 (25.4)	1.80 (45.7)	4	4.25 (108.0)	10,000
TTSL4VC3-5	GMV3 SL	White	1.00 (25.4)	2.44 (62.0)	1.00 (25.4)	1.00 (25.4)	2.83 (72.0)	4	4.25 (108.0)	5000
TTSL6V3-2.5	GMV3 SL	White	1.00 (25.4)	3.94 (100.1)	1.00 (25.4)	1.00 (25.4)	4.25 (108.0)	4	4.25 (108.0)	2500
TTSL3VC3-1	GMV3 SL	White	2.00 (50.8)	1.50 (38.1)	0.50 (12.7)	2.00 (50.8)	1.80 (45.7)	2	4.25 (108.0)	1000
TTSL7VC3-1	GMV3 SL	White	2.00 (50.8)	3.94 (100.1)	1.00 (25.4)	2.00 (50.8)	4.25 (108.0)	2	4.25 (108.0)	1000



Heat Shrink Wire and Cable Markers

- Produce durable, high quality permanent heat shrink markers
- Pre-cut tubing mounted on plastic carrier
- Service Temperature Range: -22°F to 220°F (-30°C to 105°C)
- Shrink Ratio 3:1 @ 212°F (100°C)
- Flammability: Meets U.L. Standard 224 for flammability
- Panduit Heat Shrink Tools and Accessories shown on [page 123](#)
- For best results use with Panduit Wax Thermal Transfer Ribbons shown on [page 46](#)

Part Number	Diameter In. (mm)	Marker Width In. (mm)	Markers Per Row	Nominal Cable Outside Diameter [■] In. (mm)	Material	Color	Mkrs Per Roll	Std. Pkg. Qty.*
LHS12W1	0.13 (3.2)	2.00 (50.8)	1	0.04 - 0.13 (1.1 - 3.2)	3:1 Flattened Polyolefin	White	500	1 Roll
LHS12W2	0.13 (3.2)	1.00 (25.4)	2				1000	1 Roll
LHS12W4	0.13 (3.2)	0.50 (12.7)	4				2000	1 Roll
LHS18W1	0.18 (4.8)	2.00 (50.8)	1	0.06 - 0.18 (1.6 - 4.8)			500	1 Roll
LHS18W2	0.18 (4.8)	1.00 (25.4)	2				1000	1 Roll
LHS18W4	0.18 (4.8)	0.50 (12.7)	4				2000	1 Roll
LHS25W1	0.25 (6.4)	2.00 (50.8)	1	0.08 - 0.25 (2.1 - 6.4)		500	1 Roll	
LHS25W2	0.25 (6.4)	1.00 (25.4)	2			1000	1 Roll	
LHS25W4	0.25 (6.4)	0.50 (12.7)	4			2000	1 Roll	
LHS50W1	0.50 (12.7)	2.00 (50.8)	1	0.17 - 0.50 (4.2 - 12.7)		500	1 Roll	
LHS50W2	0.50 (12.7)	1.00 (25.4)	2			1000	1 Roll	
LHS100W1	1.00 (25.4)	2.00 (50.8)	1	0.33 - 1.00 (8.4 - 25.4)		250	1 Roll	
LHS100W2	1.00 (25.4)	1.00 (25.4)	2		500	1 Roll		
LHS12Y1	0.13 (3.2)	2.00 (50.8)	1	0.04 - 0.13 (1.1 - 3.2)	3:1 Flattened Polyolefin	Yellow	500	1 Roll
LHS12Y2	0.13 (3.2)	1.00 (25.4)	2				1000	1 Roll
LHS12Y4	0.13 (3.2)	0.50 (12.7)	4				2000	1 Roll
LHS18Y1	0.18 (4.8)	2.00 (50.8)	1	0.06 - 0.18 (1.6 - 4.8)			500	1 Roll
LHS18Y2	0.18 (4.8)	1.00 (25.4)	2				1000	1 Roll
LHS18Y4	0.18 (4.8)	0.50 (12.7)	4				2000	1 Roll
LHS25Y1	0.25 (6.4)	2.00 (50.8)	1	0.08 - 0.25 (2.1 - 6.4)		500	1 Roll	
LHS25Y2	0.25 (6.4)	1.00 (25.4)	2			1000	1 Roll	
LHS25Y4	0.25 (6.4)	0.50 (12.7)	4			2000	1 Roll	
LHS50Y1	0.50 (12.7)	2.00 (50.8)	1	0.17 - 0.50 (4.2 - 12.7)		500	1 Roll	
LHS50Y2	0.50 (12.7)	1.00 (25.4)	2			1000	1 Roll	
LHS100Y1	1.00 (25.4)	2.00 (50.8)	1	0.33 - 1.00 (8.4 - 25.4)		250	1 Roll	
LHS100Y2	1.00 (25.4)	1.00 (25.4)	2		500	1 Roll		

[■]Refer to Wire Size Selection Guide on [page 196](#) to review diameters of commonly used cables
^{*}Order number of rolls required in multiples of Std. Pkg. Qty.

Thermal Transfer Ribbons



Designed specifically for outstanding images in harsh environments on a wide spectrum of materials.

Available in two types:

- Resin for harsh environments
- Wax for general purpose labeling

High Performance Resin Ribbons

Key Features

- Excellent durability
- High speed (up to 12 inches per second)
- Extended print head life because they use a low heat setting

Resistant To

- Gasoline, Alcohol, Abrasion, UV Light, Other Chemicals (contact factory for detailed technical data)

Perfect For

- Electrical / Electronic Marking
- Rating Plate Labeling
- Laboratory and Health Care Labeling
- Automotive Identification
- Asset Labeling
- Shelf Labeling
- Shipment Tracking

General Purpose Wax Ribbons

Key Features

- Economical
- High print speed (up to 12 inches per second)
- Recommended for printing on Panduit Self-Laminating Labels (see [pg. 36](#)) and Heat Shrink Labels (see [pg. 45](#))

Perfect For

- General Purpose Labeling
- Product Labeling
- Graphics
- Inventory Labeling
- Shipment Tracking

Ribbon Style	Width In. (mm)	Length Ft. (m)	Type	Color	Part Number	Std. Pkg. Qty.*
E	2.50 (63.5)	280 (85.3)	Resin	Black	TTR2-BL	1
			Resin	White	TTR2-WH	
			Wax	Black	TTRW2-BL	
	4.33 (110.0)		Resin	Black	TTR-BL	
			Resin	White	TTR-WH	
			Wax	Black	TTRW-BL	
S	4.33 (110.0)	1181 (360.0)	Resin	Black	TTR4-BL-S	
			Wax	Black	TTR4W-BL-S	
	6.50 (165.1)		Resin	Black	TTR6-BL-S	
			Wax	Black	TTR6W-BL-S	
Z	4.33 (110.0)	984 (300.0)	Resin	Black	TTR4-BL-Z	
			Wax	Black	TTR4W-BL-Z	
	6.50 (165.1)		Resin	Black	TTR6-BL-Z	
			Wax	Black	TTR6W-BL-Z	

*Order number of ribbons required in multiples of Std. Pkg. Qty.

To determine which ribbon style is designed for your printer, see chart on the following page.

Thermal Transfer Ribbons

Use the chart below to determine which ribbon style is designed for your printer. See previous page for part numbers available in each style.

Printer	Ribbon Style (see pg. 46)
A	
Acumark 3000	S
Allegro	S
Antonson 407	Z
Astromed LC 5000	S
Atec Swedot 201, 205	S
Atech 196	Z
Auto Label XT-500	S
Avery Dennison 3000, 3500, 3520, 4200, 4500, 5000, 5300, 5350, TLP 40, TLP 46	S
B	
Brady 200 Series, 300 Series	Z
Brady 2024, 2034	S
C	
C. Itoh T-4	S
Codewriter 5106	Z
Codewriter Legacy, UTICoder 2104T	S
Cognitive Solutions Blazer	S
Computer Identics	Z
Computype Sigma	S
Comstar, All	S
D	
Data Ply 909, 989, 990	S
Datamax, All	S
DH Technology Blaster Advantage	S
Diagraph, All	S
DPC 5207	S
E	
Eltron 2242	E
F	
Facit T400	Z
Fargo, All	S
I	
Imtec 3100, 3130, 3500	Z
Intacs 3528	S
Intermec 3400, 3600, 4000, 4100	S
K	
Kimball MEQ 1634	S

Printer	Ribbon Style (see pg. 46)
L	
Label Jet 2600	S
Labelaire 2136, 2137-P, 2138	S
Labelaire 2137-Z	Z
Lowery 4090, 4130, 4140, 4142, 4220	Z
Lowery 4120, 4121	S
M	
Markem SK 4200	Z
Mars MEQ 1634	S
Matthews 1300	Z
Matthews 4100, 4101	S
N	
Novexx, All	S
P	
Panduit PTR2	E
Panduit PTR3	S
Printstar 90-130	Z
R	
RJS, All except near edge printers	Z
Ring, All	Z
S	
Sato, All	S
Soabar SPX 30, 320, 350, 360, 362, 370, 380, 386, 390, Travier	S
Swedot 196	Z
T	
Tharo, All	S
U	
Universal DP1300, DP2300	Z
Unimark V300, 301, 340, 400, 420, 500, 522	S
W	
Weber 75, 76	S
Weber Legtronic 78, 79, 80, 81,82, 85, 86, 93	Z
Willett 2600, 2610, 8400, 8450	S
Willett 2603	Z
Z	
Zebra, All	Z

Contact factory for information on printer models not listed.



Panduit offers high quality ink jet labels in a variety of materials, sizes and styles.

Panduit Ink Jet Labels are used for a wide variety of identification purposes including bar code labeling, asset identification and shipment tracking. The wide range of label sizes available provides a label for every application. The need for large inventories of custom preprinted labels and long lead times is eliminated, providing an economical solution to all of your labeling needs. Labels are supplied on 8.50" x 11.00" (215.9 x 279.4 mm) sheets.

Smear resistant ink jet cartridges and refills are also available to provide optimal smear resistance. The ink is formulated for superior performance with Panduit Ink Jet Label Coatings.



Self-Laminating Ink Jet Labels

- These labels are used most commonly for marking wires, cables, test tubes and other cylindrical objects in applications where a protective overlaminate is needed.



Specialized Blank Ink Jet Labels

- Panduit offers labels in a variety of high performance materials for a wide range of applications from labeling circuit boards to asset management to wire identification. These labels are designed for specific purposes and are available in four materials to meet your application requirements.

Suggested Applications for Ink Jet Labels



Electronic Labeling

Recommended Materials

Material	Color	Usage	Part Number Listing on Page
GMC5-W Vinyl Cloth	White	Indoor	53



Bar Code and General Labeling

Recommended Materials

Material	Color	Usage	Part Number Listing on Page
GMP5-W Destructible Paper	White	Indoor	51
GM5-W Polyester	White	Indoor	52



Shipment Tracking Labels

Recommended Materials

Material	Color	Usage	Part Number Listing on Page
GMP5-W Destructible Paper	White	Indoor	51
GM5-W Polyester	White	Indoor	52



Network Systems Labeling

Recommended Materials

Material	Color	Usage	Part Number Listing on Page
GMPO5-W Polyolefin	White	Indoor	53

Ink Jet Labels

Ink Jet Material Selection Guide

Choose the material that best suits your application:

Material Code	Material Type	Temperature Range	Key Features	Color	Outdoor Rated	Hazardous Environment	UL Rec.	CSA
GMP5-W	Destructible Paper	-65°F to 200°F (-54°C to 93°C)	Tamper resistant litho paper for permanent applications	White	No	No	No	No
GMPO5-W	Polyolefin	-50°F to 120°F (-46°C to 49°C)	Durable, pliable material with permanent adhesive	White	No	No	No	No
GMC5-W	Vinyl Cloth	-50°F to 170°F (-46°C to 77°C)	Repositionable adhesive; pliable material good for rough, textured surfaces	White	No	No	No	No
GMY5-W	White Polyester	-40°F to 311°F (-40°C to 154°C)	Durable; high temperature; does not stretch or tear	White	No	No	No	No

Self-Laminating Ink Jet Labels

- Clear overlamine protects legend for permanent, clean identification
- Ideal for wire and cable marking

Part Number	Material	Print-On Area Color	Label Size Width x Length In. (mm)	Print-On Area Width x Length In. (mm)	Nominal Cable Outside Diameter " In. (mm)	Dwg. Page No.	Std. Pkg. Qty.*
JSL1-Y3-5	Self-Laminating Polyester	White	0.50 x 0.75 (12.7 x 19.1)	0.50 x 0.34 (12.7 x 8.6)	0.11 - 0.13 (2.8 - 3.3)	54	5000
JSL2-Y3-5			0.50 x 1.50 (12.7 x 38.1)	0.50 x 0.50 (12.7 x 12.7)	0.16 - 0.32 (4.0 - 8.1)	54	5000
JSL9-Y3-2.5			0.70 x 1.33 (17.8 x 33.8)	0.70 x 0.33 (17.8 x 8.4)	0.10 - 0.32 (2.7 - 8.1)	54	2500
JSL10-Y3-1			0.90 x 2.17 (22.9 x 55.1)	0.90 x 0.50 (22.9 x 12.7)	0.16 - 0.53 (4.0 - 13.5)	54	1000
JSL3-Y3-2.5			1.00 x 0.75 (25.4 x 19.1)	1.00 x 0.34 (25.4 x 8.6)	0.11 - 0.13 (2.8 - 3.3)	54	2500
JSL4-Y3-2.5			1.00 x 1.00 (25.4 x 25.4)	1.00 x 0.34 (25.4 x 8.6)	0.11 - 0.21 (2.8 - 5.3)	54	2500
JSL5-Y3-2.5			1.00 x 1.33 (25.4 x 33.8)	1.00 x 0.47 (25.4 x 11.9)	0.15 - 0.27 (3.8 - 6.9)	54	2500
JSL11-Y3-1			1.00 x 2.67 (25.4 x 67.8)	1.00 x 0.67 (25.4 x 16.9)	0.21 - 0.64 (5.4 - 16.2)	54	1000
JSL6-Y3-1			1.00 x 3.17 (25.4 x 80.5)	1.00 x 0.97 (25.4 x 24.6)	0.31 - 0.70 (7.8 - 17.8)	54	1000
JSL12-Y3-1			1.20 x 2.67 (30.5 x 67.8)	1.20 x 0.83 (30.5 x 21.1)	0.26 - 0.58 (6.7 - 14.9)	54	1000
JSL7-Y3-1			2.00 x 1.50 (50.8 x 38.1)	2.00 x 0.50 (50.8 x 12.7)	0.16 - 0.32 (4.0 - 8.1)	54	1000
JSL8-Y3-1			2.00 x 3.17 (50.8 x 80.5)	2.00 x 1.00 (50.8 x 25.4)	0.32 - 0.69 (8.1 - 17.5)	54	1000

*Refer to Wire Size Selection Guide on page 196 to review diameters of commonly used cables

Blank Ink Jet Labels by Material

GMP5-W Destructible Paper—Indoor Applications

Key Features

- Tamper resistant litho paper for permanent applications
- Most economical labeling solution

Suggested Uses

- Bar Code and General Labeling
- Shipment Tracking
- Short term applications

Part Number	Material	Color	Label Size Width x Length In. (mm)	Dwg. Page No.	Std. Pkg. Qty.*
JL7P-10	GMP5-W Destructible Paper	White	0.25 x 1.00 (6.4 x 25.4)	55	10,000
JL8P-10			0.38 x 1.00 (9.5 x 25.4)	55	10,000
JL172P-10			0.50 x 0.80 (12.7 x 20.3)	55	10,000
JL9P-10			0.50 x 1.00 (12.7 x 25.4)	55	10,000
JL12P-5			0.50 x 1.50 (12.7 x 38.1)	55	5000
JL10P-5			0.75 x 1.00 (19.1 x 25.4)	55	5000
JL35P-2.5			0.75 x 1.50 (19.1 x 38.1)	55	2500
JL17P-2.5			0.83 x 1.88 (21.2 x 47.6)	56	2500
JL902P-2.5			1.00 x 1.75 (25.4 x 44.5)	56	2500
JL903P-0.5			2.75 x 2.75 (69.9 x 69.9)	56	500
JL25P-SH			8.50 x 11.00 (215.9 x 279.4)	56	25

*Order number of labels required in multiples of Std. Pkg. Qty.

Blank Ink Jet Labels by Material (cont.)

GMPO5-W Polyolefin—Indoor Applications

Key Features

- Provides excellent print quality
- Perfect for flat or curved surfaces
- Adhesive becomes permanent on most surfaces after 24 hours

Suggested Uses

- Asset Labeling
- Tool Check-In and Check-Out

Part Number	Material	Color	Label Size Width x Length In. (mm)	Dwg. Page No.	Std. Pkg. Qty.*
JL7PO-10	GMPO5-W Polyolefin	White	0.25 x 1.00 (6.4 x 25.4)	55	10,000
JL14PO-10			0.25 x 1.50 (6.4 x 38.1)	55	10,000
JLEFPD-1			0.30 x 2.90 (7.6 x 73.7)	55	1000
JL8PO-10			0.38 x 1.00 (9.5 x 25.4)	55	10,000
JL16PO-2.5			0.38 x 1.88 (9.5 x 47.6)	55	2500
JL19PO-1			0.38 x 3.00 (9.5 x 76.2)	55	1000
JL9PO-10			0.50 x 1.00 (12.7 x 25.4)	55	10,000
JL24PO-5			0.56 x 0.19 (14.3 x 4.8)	55	5000
JL23PO-1			0.56 x 0.56 (14.3 x 14.3)	55	1000
JLCPL-1			0.61 x 0.33 (15.5 x 8.4)	55	1000
JL901PO-5			0.75 x 1.25 (19.1 x 31.8)	55	5000
JL35PO-2.5			0.75 x 1.50 (19.1 x 38.1)	55	2500
JL42PO-1			0.80 x 1.50 (20.3 x 38.1)	56	1000
JL17PO-1			0.83 x 1.88 (21.2 x 47.6)	56	1000
JL17PO-2.5			0.83 x 1.88 (21.2 x 47.6)	56	2500
JL412PO-1			1.38 x 0.19 (34.9 x 4.8)	56	1000
JL33PO-2.5			1.44 x 0.50 (36.5 x 12.7)	56	2500
JLEFPS-1			1.80 x 0.38 (45.7 x 9.5)	56	1000
JL18PO-1			1.88 x 1.33 (47.8 x 33.8)	56	1000
JL41PO-0.5			2.00 x 0.90 (50.8 x 22.9)	56	500
JL22PO-1			7.88 x 0.50 (200.0 x 12.7)	56	1000

GM5-W Polyester—Indoor Applications

Key Features

- Tough polyester provides excellent durability and UV resistance
- Adhesive becomes permanent on most surfaces after 24 hours
- Does not stretch or easily tear

Suggested Uses

- High Performance labeling
- Bar Code and General labeling
- Inventory Tracking

Part Number	Material	Color	Label Size Width x Length In. (mm)	Dwg. Page No.	Std. Pkg. Qty.*
JL32Y-10	GM5-W Polyester	White	0.20 x 0.65 (5.1 x 16.5)	55	10,000
JL4Y-10			0.25 x 0.65 (6.4 x 16.5)	55	10,000
JL274Y-10			0.25 x 0.75 (6.4 x 19.1)	55	10,000
JL5Y-10			0.25 x 0.80 (6.4 x 20.3)	55	10,000
JL287Y-10			0.25 x 0.90 (6.4 x 22.9)	55	10,000
JL7Y-10			0.25 x 1.00 (6.4 x 25.4)	55	10,000
JL14Y-10			0.25 x 1.50 (6.4 x 38.1)	55	10,000
JL15Y-10			0.25 x 1.88 (6.4 x 47.6)	55	10,000
JL2Y-10			0.38 x 0.38 (9.5 x 9.5)	55	10,000
JL8Y-10			0.38 x 1.00 (9.5 x 25.4)	55	10,000
JL16Y-5			0.38 x 1.88 (9.5 x 47.6)	55	5000
JL111Y-5			0.38 x 2.00 (9.5 x 50.8)	55	5000
JL19Y-2.5			0.38 x 3.00 (9.5 x 76.2)	55	2500
JL172Y-10			0.50 x 0.80 (12.7 x 20.3)	55	10,000
JL9Y-10			0.50 x 1.00 (12.7 x 25.4)	55	10,000
JL12Y-5			0.50 x 1.50 (12.7 x 38.1)	55	5000
JL3Y-10			0.75 x 0.50 (19.1 x 12.7)	55	10,000
JL10Y-5			0.75 x 1.00 (19.1 x 25.4)	55	5000
JL901Y-5			0.75 x 1.25 (19.1 x 31.8)	55	5000
JL35Y-2.5			0.75 x 1.50 (19.1 x 38.1)	55	2500
JL17Y-2.5			0.83 x 1.88 (21.2 x 47.6)	56	2500
JL902Y-2.5			1.00 x 1.75 (25.4 x 44.5)	56	2500
JL33Y-5			1.44 x 0.50 (36.5 x 12.7)	56	5000
JL25Y-SH			8.50 x 11.00 (215.9 x 279.4)	56	25

Blank Ink Jet Labels by Material (cont.)

GMC5-W Vinyl Cloth, Repositionable Adhesive—Indoor Applications

Key Features

- Repositionable adhesive ideal for identification of chips, boards and other electronic labeling
- Label removes with no sticky residue
- Pliable

Suggested Uses

- Electronic Labeling
- Good for rough, textured surfaces

Part Number	Material	Color	Label Size Width x Length In. (mm)	Dwg. Page No.	Std. Pkg. Qty.*
JL32C-10	GMC5-W Vinyl Cloth	White	0.20 x 0.65 (5.1 x 16.5)	55	10,000
JL14C-10			0.25 x 1.50 (6.4 x 38.1)	55	10,000
JL8C-10			0.38 x 1.00 (9.5 x 25.4)	55	10,000
JL111C-5			0.38 x 2.00 (9.5 x 50.8)	55	5000
JL9C-10			0.50 x 1.00 (12.7 x 25.4)	55	10,000
JL3C-10			0.75 x 0.50 (19.1 x 12.7)	55	10,000
JL10C-5			0.75 x 1.00 (19.1 x 25.4)	55	5000
JL901C-5			0.75 x 1.25 (19.1 x 31.8)	55	5000
JL35C-2.5			0.75 x 1.50 (19.1 x 38.1)	55	2500
JL33C-5			1.44 x 0.50 (36.5 x 12.7)	56	5000
JL900C-2.5			1.44 x 0.80 (36.5 x 20.3)	56	2500

TIA/EIA-606 Compliant Network Systems Labeling



Adhesive 110 Punchdown Block Labels

- Eliminate the need for standard paper designation strips
- Labels are placed on top of label holders

Part Number	Material	Color	Label Width In. (mm)	Label Length In. (mm)	Labels Per Sheet	Std. Pkg. Qty.*
JL22PO-1	GMPO5-W Polyolefin	White	7.88 (200.0)	0.50 (12.7)	15	1000

*Order number of labels required in multiples of Std. Pkg. Qty.



Adhesive Label for Patch Panels and Modular Furniture Faceplates

- Label is perforated on black lines to be used in 2 position, 4 position, or 6 position applications

Part Number	Material	Color	Label Width In. (mm)	Label Length In. (mm)	Labels Per Sheet	Std. Pkg. Qty.*
JLCPL-1	GMPO5-W Polyolefin	White	0.61 (15.5)	0.33 (8.4)	276	1000

*Order number of labels required in multiples of Std. Pkg. Qty.



Faceplate Adhesive Labels

- For use with **MINI-COM®** Executive and Designer Series Faceplates
- Designed to fit on vinyl insert provided with faceplate
- Single and Double Gang versions available
- Can also be used to identify **MINI-COM** Surface Mount Boxes

Part Number	Faceplate Type	Material	Color	Label Width In. (mm)	Label Length In. (mm)	Labels Per Sheet	Std. Pkg. Qty.*
JLEFPS-1	Single Gang	GMPO5-W Polyolefin	White	1.80 (45.7)	0.38 (9.5)	84	1000
JLEFPD-1	Double Gang		White	0.30 (7.6)	2.90 (73.7)	63	1000

*Order number of labels required in multiples of Std. Pkg. Qty.

Smear Resistant Ink Jet Cartridges and Refills

- Recommended for use with Panduit Ink Jet Labels to provide optimal smear resistance
- Ink is formulated for superior performance with our ink jet label coatings
- Cartridges and refill kits are available for Hewlett Packard^ HP500 and HP600 printers
- Standard ink jet inks may be used, but may not provide best smear resistance characteristics

^Hewlett Packard is a registered trademark of Hewlett Packard Company

Part Number	Description	Std. Pkg. Qty.*
JT500	Cartridge for H500	1
JT600	Cartridge for HP600	1
JTK	Refill Kit	1
JT1	Ink for Refills	1

*Order number required in multiples of Std. Pkg. Qty.

Self-Laminating Ink Jet Labels by Size

- For best results use with Panduit Smear Resistant Ink Jet Cartridges and Refills.

Note: Panduit Ink Jet Labels are designed for light to medium ink coverage. Graphics or heavy ink coverage may result in smearing, ink bleed or excessive dry time.

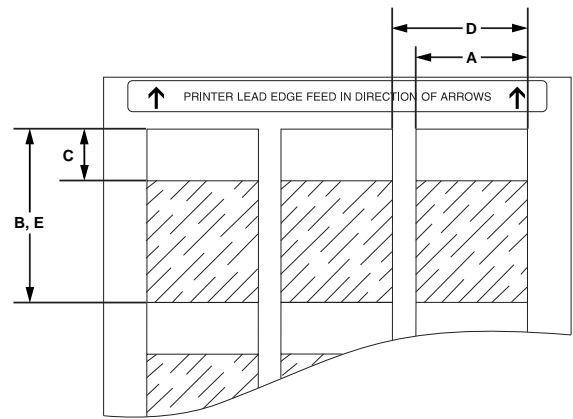

Part Number	Material	Print-On Area Color	Label Width A In. (mm)	Label Length B In. (mm)	Print-On Area Length C In. (mm)	Horizontal Repeat D In. (mm)	Vertical Repeat E In. (mm)	No. of Col.	No. of Rows	Labels Per Sheet	Sheets Per Pkg.	Std. Pkg. Qty.*
JSL1-Y3-5	Self-Laminating Polyester	White	0.50 (12.7)	0.75 (19.1)	0.34 (8.6)	0.60 (15.2)	0.75 (19.1)	13	12	156	33	5000
JSL2-Y3-5			0.50 (12.7)	1.50 (38.1)	0.50 (12.7)	0.60 (15.2)	1.50 (38.1)	13	6	78	65	5000
JSL9-Y3-2.5			0.70 (17.8)	1.33 (33.8)	0.33 (8.4)	0.70 (17.8)	1.33 (33.8)	10	8	80	32	2500
JSL10-Y3-1			0.90 (22.9)	2.17 (55.1)	0.50 (12.7)	0.90 (22.9)	2.17 (55.1)	8	5	40	25	1000
JSL3-Y3-2.5			1.00 (25.4)	0.75 (19.1)	0.34 (8.6)	1.10 (27.9)	0.75 (19.1)	7	12	84	30	2500
JSL4-Y3-2.5			1.00 (25.4)	1.00 (25.4)	0.34 (8.6)	1.10 (27.9)	1.00 (25.4)	7	10	70	36	2500
JSL5-Y3-2.5			1.00 (25.4)	1.33 (33.8)	0.47 (11.9)	1.10 (27.9)	1.33 (33.8)	7	7	49	52	2500
JSL11-Y3-1			1.00 (25.4)	2.67 (67.8)	0.67 (16.9)	1.00 (25.4)	2.67 (67.8)	7	4	28	36	1000
JSL6-Y3-1			1.00 (25.4)	3.17 (80.5)	0.97 (24.6)	1.10 (27.9)	3.17 (80.5)	7	3	21	48	1000
JSL12-Y3-1			1.20 (30.5)	2.67 (67.8)	0.83 (21.1)	1.20 (30.5)	2.67 (67.8)	6	4	24	42	1000
JSL7-Y3-1			2.00 (50.8)	1.50 (38.1)	0.50 (12.7)	2.00 (50.8)	1.50 (38.1)	4	6	24	42	1000
JSL8-Y3-1			2.00 (50.8)	3.17 (80.5)	1.00 (25.4)	2.50 (63.5)	3.17 (80.5)	3	3	9	112	1000

*Order number of labels required in multiples of Std. Pkg. Qty.

Blank Ink Jet Labels by Size

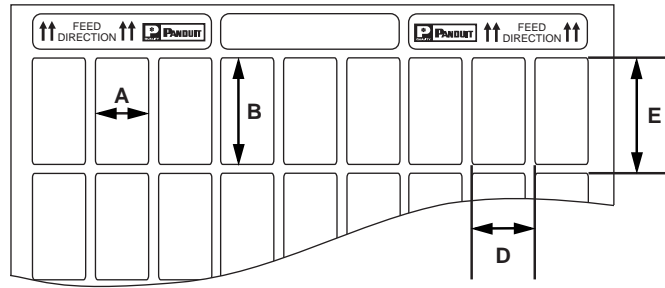

Part Number	Material	Color	Label Width A In. (mm)	Label Length B In. (mm)	Horizontal Repeat D In. (mm)	Vertical Repeat E In. (mm)	No. of Col.	No. of Rows	Labels Per Sheet	Sheets Per Pkg.	Std. Pkg. Qty. *
JL32C-10	Vinyl Cloth	White	0.20 (5.1)	0.65 (16.5)	0.31 (7.8)	0.74 (18.8)	26	13	338	30	10,000
JL32Y-10	Polyester	White	0.20 (5.1)	0.65 (16.5)	0.31 (7.8)	0.74 (18.8)	26	13	338	30	10,000
JL4Y-10	Polyester	White	0.25 (6.4)	0.65 (16.5)	0.32 (8.1)	0.74 (18.8)	25	13	325	31	10,000
JL274Y-10	Polyester	White	0.25 (6.4)	0.75 (19.1)	0.32 (8.1)	0.85 (21.6)	25	11	275	37	10,000
JL5Y-10	Polyester	White	0.25 (6.4)	0.80 (20.3)	0.31 (7.9)	0.87 (22.1)	25	11	275	37	10,000
JL287Y-10	Polyester	White	0.25 (6.4)	0.90 (22.9)	0.32 (8.1)	0.97 (24.6)	25	10	250	40	10,000
JL7P-10	Destructible Paper	White	0.25 (6.4)	1.00 (25.4)	0.32 (8.1)	1.07 (27.2)	25	9	225	45	10,000
JL7PO-10	Polyolefin	White	0.25 (6.4)	1.00 (25.4)	0.32 (8.1)	1.07 (27.2)	25	9	225	45	10,000
JL7Y-10	Polyester	White	0.25 (6.4)	1.00 (25.4)	0.32 (8.1)	1.07 (27.2)	25	9	225	45	10,000
JL14C-10	Vinyl Cloth	White	0.25 (6.4)	1.50 (38.1)	0.32 (8.1)	1.63 (41.3)	25	6	150	67	10,000
JL14PO-10	Polyolefin	White	0.25 (6.4)	1.50 (38.1)	0.32 (8.1)	1.63 (41.3)	25	6	150	67	10,000
JL14Y-10	Polyester	White	0.25 (6.4)	1.50 (38.1)	0.32 (8.1)	1.63 (41.3)	25	6	150	67	10,000
JL15Y-10	Polyester	White	0.25 (6.4)	1.88 (47.6)	0.32 (8.1)	1.95 (49.4)	25	5	125	80	10,000
JLEFPD-1	Polyolefin	White	0.30 (7.6)	2.90 (73.7)	0.38 (9.5)	3.30 (83.8)	21	3	63	16	1000
JL2Y-10	Polyester	White	0.38 (9.5)	0.38 (9.5)	0.47 (11.9)	0.45 (11.6)	17	21	357	29	10,000
JL8C-10	Vinyl Cloth	White	0.38 (9.5)	1.00 (25.4)	0.47 (11.9)	1.07 (27.2)	17	9	153	66	10,000
JL8P-10	Destructible Paper	White	0.38 (9.5)	1.00 (25.4)	0.47 (11.9)	1.07 (27.2)	17	9	153	66	10,000
JL8PO-10	Polyolefin	White	0.38 (9.5)	1.00 (25.4)	0.47 (11.9)	1.07 (27.2)	17	9	153	66	10,000
JL8Y-10	Polyester	White	0.38 (9.5)	1.00 (25.4)	0.47 (11.9)	1.07 (27.2)	17	9	153	66	10,000
JL16PO-2.5	Polyolefin	White	0.38 (9.5)	1.88 (47.6)	0.47 (11.9)	1.95 (49.4)	17	5	85	30	2500
JL16Y-5	Polyester	White	0.38 (9.5)	1.88 (47.6)	0.47 (11.9)	1.95 (49.4)	17	5	85	59	5000
JL111C-5	Vinyl Cloth	White	0.38 (9.5)	2.00 (50.8)	0.47 (11.9)	2.25 (57.2)	17	4	68	74	5000
JL111Y-5	Polyester	White	0.38 (9.5)	2.00 (50.8)	0.47 (11.9)	2.25 (57.2)	17	4	68	74	5000
JL19PO-1	Polyolefin	White	0.38 (9.5)	3.00 (76.2)	0.47 (11.9)	3.20 (81.3)	17	3	51	20	1000
JL19Y-2.5	Polyester	White	0.38 (9.5)	3.00 (76.2)	0.47 (11.9)	3.20 (81.3)	17	3	51	50	2500
JL172P-10	Destructible Paper	White	0.50 (12.7)	0.80 (20.3)	0.57 (14.5)	0.87 (22.1)	14	11	154	65	10,000
JL172Y-10	Polyester	White	0.50 (12.7)	0.80 (20.3)	0.57 (14.5)	0.87 (22.1)	14	11	154	65	10,000
JL9C-10	Vinyl Cloth	White	0.50 (12.7)	1.00 (25.4)	0.57 (14.5)	1.07 (27.2)	14	9	126	80	10,000
JL9P-10	Destructible Paper	White	0.50 (12.7)	1.00 (25.4)	0.57 (14.5)	1.07 (27.2)	14	9	126	80	10,000
JL9PO-10	Polyolefin	White	0.50 (12.7)	1.00 (25.4)	0.57 (14.5)	1.07 (27.2)	14	9	126	80	10,000
JL9Y-10	Polyester	White	0.50 (12.7)	1.00 (25.4)	0.57 (14.5)	1.07 (27.2)	14	9	126	80	10,000
JL12P-5	Destructible Paper	White	0.50 (12.7)	1.50 (38.1)	0.57 (14.5)	1.63 (41.3)	14	6	84	60	5000
JL12Y-5	Polyester	White	0.50 (12.7)	1.50 (38.1)	0.57 (14.5)	1.63 (41.3)	14	6	84	60	5000
JL24PO-5	Polyolefin	White	0.56 (14.3)	0.19 (4.8)	0.66 (16.8)	0.25 (6.4)	12	38	456	11	5000
JL23PO-1	Polyolefin	White	0.56 (14.3)	0.56 (14.3)	0.66 (16.8)	0.64 (16.2)	12	15	180	6	1000
JLCLP-1	Polyolefin	White	0.61 (15.5)	0.33 (8.4)	0.61 (15.5)	0.41 (10.4)	12	23	276	4	1000
JL3C-10	Vinyl Cloth	White	0.75 (19.1)	0.50 (12.7)	0.89 (22.7)	0.58 (14.6)	9	17	153	66	10,000
JL3Y-10	Polyester	White	0.75 (19.1)	0.50 (12.7)	0.89 (22.7)	0.58 (14.6)	9	17	153	66	10,000
JL10C-5	Vinyl Cloth	White	0.75 (19.1)	1.00 (25.4)	0.89 (22.7)	1.07 (27.2)	9	9	81	62	5000
JL10P-5	Destructible Paper	White	0.75 (19.1)	1.00 (25.4)	0.89 (22.7)	1.07 (27.2)	9	9	81	62	5000
JL10Y-5	Polyester	White	0.75 (19.1)	1.00 (25.4)	0.89 (22.7)	1.07 (27.2)	9	9	81	62	5000
JL901C-5	Vinyl Cloth	White	0.75 (19.1)	1.25 (31.8)	0.89 (22.7)	1.38 (35.1)	9	7	63	80	5000
JL901PO-5	Polyolefin	White	0.75 (19.1)	1.25 (31.8)	0.89 (22.7)	1.38 (35.1)	9	7	63	80	5000
JL901Y-5	Polyester	White	0.75 (19.1)	1.25 (31.8)	0.89 (22.7)	1.38 (35.1)	9	7	63	80	5000

Labels are supplied on 8.50" x 11.00" (215.9 x 279.4 mm) sheets.
*Order number of labels required in multiples of Std. Pkg. Qty.

Blank Ink Jet Labels by Size (cont.)



Part Number	Material	Color	Label Width A In. (mm)	Label Length B In. (mm)	Horizontal Repeat D In. (mm)	Vertical Repeat E In. (mm)	No. of Col.	No. of Rows	Labels Per Sheet	Sheets Per Pkg.	Std. Pkg. Qty.*
JL35C-2.5	Vinyl Cloth	White	0.75 (19.1)	1.50 (38.1)	0.89 (22.7)	1.63 (41.3)	9	6	54	47	2500
JL35P-2.5	Destructible Paper	White	0.75 (19.1)	1.50 (38.1)	0.89 (22.7)	1.63 (41.3)	9	6	54	47	2500
JL35PO-2.5	Polyolefin	White	0.75 (19.1)	1.50 (38.1)	0.89 (22.7)	1.63 (41.3)	9	6	54	47	2500
JL35Y-2.5	Polyester	White	0.75 (19.1)	1.50 (38.1)	0.89 (22.7)	1.63 (41.3)	9	6	54	47	2500
JL42PO-1	Polyolefin	White	0.80 (20.3)	1.50 (38.1)	0.89 (22.5)	1.58 (40.0)	9	6	54	19	1000
JL17P-2.5	Destructible Paper	White	0.83 (21.2)	1.88 (47.6)	1.01 (25.7)	1.95 (49.4)	8	5	40	63	2500
JL17PO-1	Polyolefin	White	0.83 (21.2)	1.88 (47.6)	1.01 (25.7)	1.95 (49.4)	8	5	40	25	1000
JL17PO-2.5	Polyolefin	White	0.83 (21.2)	1.88 (47.6)	1.01 (25.7)	1.95 (49.4)	8	5	40	63	2500
JL17Y-2.5	Polyester	White	0.83 (21.2)	1.88 (47.6)	1.01 (25.7)	1.95 (49.4)	8	5	40	63	2500
JL902P-2.5	Destructible Paper	White	1.00 (25.4)	1.75 (44.5)	1.15 (29.2)	1.88 (47.6)	7	5	35	72	2500
JL902Y-2.5	Polyester	White	1.00 (25.4)	1.75 (44.5)	1.15 (29.2)	1.88 (47.6)	7	5	35	72	2500
JL412PO-1	Polyolefin	White	1.38 (34.9)	0.19 (4.8)	1.63 (41.4)	0.25 (6.4)	5	38	190	6	1000
JL33C-5	Vinyl Cloth	White	1.44 (36.5)	0.50 (12.7)	1.62 (41.0)	0.58 (14.6)	5	17	85	59	5000
JL33PO-2.5	Polyolefin	White	1.44 (36.5)	0.50 (12.7)	1.62 (41.0)	0.58 (14.6)	5	17	85	30	2500
JL33Y-5	Polyester	White	1.44 (36.5)	0.50 (12.7)	1.62 (41.0)	0.58 (14.6)	5	17	85	59	5000
JL900C-2.5	Vinyl Cloth	White	1.44 (36.5)	0.80 (20.3)	1.62 (41.0)	0.87 (22.1)	5	11	55	46	2500
JLEFPS-1	Polyolefin	White	1.80 (45.7)	0.38 (9.5)	2.01 (51.1)	0.45 (11.6)	4	21	84	12	1000
JL18PO-1	Polyolefin	White	1.88 (47.8)	1.33 (33.8)	2.01 (51.1)	1.58 (40.13)	4	6	24	42	1000
JL41PO-0.5	Polyolefin	White	2.00 (50.8)	0.90 (22.9)	2.95 (74.9)	1.05 (26.7)	3	9	27	19	500
JL903P-0.5	Destructible Paper	White	2.75 (69.9)	2.75 (69.9)	2.75 (69.9)	3.15 (80.0)	3	3	9	56	500
JL22PO-1	Polyolefin	White	7.88 (200.0)	0.50 (12.7)	—	0.63 (15.9)	1	15	15	67	1000
JL25P-SH	Paper	White	8.50 (215.9)	11.00 (279.4)	—	—	1	1	1	25	25
JL25Y-SH	Polyester	White	8.50 (215.9)	11.00 (279.4)	—	—	1	1	1	25	25

Labels are supplied on 8.50" x 11.00" (215.9 x 279.4 mm) sheets.
 *Order number of labels required in multiples of Std. Pkg. Qty.

Ink Jet Labels

Laser Printable Labels - Introduction

General Information:

Panduit Laser Labels are designed to function in most desk-top laser printers.

Polyester materials are provided on a clear liner to assure clear movement throughout your printer's paper path. Most Panduit Labels are intended for flat application labeling, with the exception of Self-Laminating Polyester Labels (GMY3) and Permanent Polyolefin Labels (GMPO).

All labels can also be used in a wide variety of copiers. If you need to make many of the same label, a copier might be the quickest solution. Note: Some copiers do reduce the legend slightly so we suggest you print your legend on paper and then test transferring it to your laser label sheet with your copier.

Sheet Formats:

Panduit Laser Labels are provided in two sheet formats:

- PLL labels are provided on U.S. Letter Sheets which are 8.5" x 11.0" (215.9 mm x 279.4 mm).
- PEL labels are provided on DIN A4 Sheets which are 8.27" x 11.69" (210 mm x 297 mm).

Test Labels on Your Printer:

The rapid advances in laser printing technology make it increasingly difficult to test all laser materials on the ever increasing number of individual printer models.

The suitability of a specific material in a particular printer and for a particular application depends greatly on the printer model and operating conditions. We recommend that each user test the suggested material on their printer and in each unique application.

To order sample sheets of a specific label call your local Panduit distributor or sales office.

Choose from three types of Panduit Laser Printable Labels for excellent print quality using your own printer:



Self-Laminating Laser Printable Labels

- Panduit Blank Self-Laminating Laser Labels provide excellent print quality and clear, crisp legends. These labels are available in a thin polyester film for indoor/outdoor applications. Print on the white print-on area, then protect the legend using the clear over-laminate.



Blank Laser Printable Labels

- Panduit Blank Laser Labels are available in specific sizes for different flat labeling applications.



Litho Paper Laser Printable Labels

- These labels are made from standard litho paper and are available in common sizes. These labels can be used for a wide variety of general labeling applications.

Suggested Applications for Laser Labels



Wire and Cable Labeling

Recommended Materials

Material	Color	Usage	Part Number Listing on Page
GMPO Polyolefin	White	Indoor	61
GMY3 Polyester	White / Clear	Indoor / Outdoor	60-61



Flat Ribbon Cable Labeling

Recommended Materials

Material	Color	Usage	Part Number Listing on Page
GMPO Polyolefin	White	Indoor	61
GMY3 Polyester	White / Clear	Indoor / Outdoor	60-61



Electronic Labeling

Recommended Materials

Material	Color	Usage	Part Number Listing on Page
GMPO Polyolefin	White	Indoor	61
GMPOR Removable Polyolefin	White	Indoor	61
GMY3-C Polyester	Clear	Indoor / Outdoor	62
GMY2-W Polyester	White	Indoor / Outdoor	63-64
GMY2-Y Polyester	Yellow	Indoor / Outdoor	64-65
GMY2-S Polyester	Silver	Indoor / Outdoor	65
GMY2-STE Tamper Evident Polyester	Silver	Indoor / Outdoor	66



Name and Rating Plates

Recommended Materials

Material	Color	Usage	Part Number Listing on Page
GMPO Polyolefin	White	Indoor	61
GMY3-C Polyester	Clear	Indoor / Outdoor	62
GMY2-W Polyester	White	Indoor / Outdoor	63-64
GMY2-Y Polyester	Yellow	Indoor / Outdoor	64-65
GMY2-S Polyester	Silver	Indoor / Outdoor	65
GMY2-STE Tamper Evident Polyester	Silver	Indoor / Outdoor	66

Suggested Applications for Laser Labels (cont.)



Network Systems Labeling

Recommended Materials

Material	Color	Usage	Part Number Listing on Page
GMPO Polyolefin	White	Indoor	67-69
GMY3-C Polyester	Clear	Indoor / Outdoor	67-69
GMY2-W Polyester	White	Indoor / Outdoor	67-69



Asset Labeling

Recommended Materials

Material	Color	Usage	Part Number Listing on Page
GMY3-C Polyester	Clear	Indoor / Outdoor	62
GMY2-W Polyester	White	Indoor / Outdoor	63-64
GMY2-Y Polyester	Yellow	Indoor / Outdoor	64-65



Bar Code Labeling

Recommended Materials

Material	Color	Usage	Part Number Listing on Page
GMPO Polyolefin	White	Indoor	61
GMY2-W Polyester	White	Indoor / Outdoor	63-64



General Labeling

Recommended Materials

Material	Color	Usage	Part Number Listing on Page
Litho Paper	White	Indoor	62

Laser Label Material Selection Guide

Choose the material that best suits your application:

Material Code	Material Type	Temperature Range	Key Features	Color	Outdoor Rated	Hazardous Environment	UL Rec.	CSA
—	Litho Paper	-65°F to 200°F (-54°C to 93°C)	Standard litho paper for general indoor labeling	White	No	No	No	No
GMPO	Polyolefin	-50°F to 120°F (-46°C to 49°C)	For general identification and wire marking; excellent print quality	White	No	No	No	No
GMPOR	Removable Polyolefin	-40°F to 200°F (-40°C to 93°C)	Removable adhesive for temporary indoor applications; excellent print quality	White	No	No	No	No
GMY3	Polyester	0°F to 275°F (-18°C to 135°C)	Used for high quality indoor/outdoor self-laminating labels	Clear	Yes	Yes	No	No
GMY3-C	Polyester	0°F to 275°F (-18°C to 135°C)	Provides durability, high temperature resistance, and dimensional stability; Use on colored or clear surface	Clear	Yes	Yes	No	No
GMY3M	Polyester	0°F to 275°F (-18°C to 135°C)	Provides durability, high temperature resistance, and dimensional stability; Use on colored or clear surface	Matte Clear	Yes	Yes	No	No
GMY2-W	Polyester	0°F to 275°F (-18°C to 135°C)	Provides durability, high temperature resistance, and dimensional stability	White	Yes	Yes	Yes	Yes
GMY2-Y	Polyester	0°F to 275°F (-18°C to 135°C)	Provides durability, high temperature resistance, and dimensional stability	Yellow	Yes	Yes	Yes	Yes
GMY2-S	Polyester	0°F to 275°F (-18°C to 135°C)	Metallized polyester provides opacity, durability, high temperature resistance, and dimensional stability	Silver	Yes	Yes	No	No
GMY2-STE	Tamper Evident Polyester	-40°F to 302°F (-40°C to 150°C)	Destructible material; label cannot be completely removed; for tamper evident applications	Silver	Yes	No	No	No



Self-Laminating Labels

- Print on the white print-on area and over-laminate with clear portion for permanent, clean identification
- Preferred material chosen for most OEM applications
- Thin film with permanent adhesive

Clear Polyester – Indoor/Outdoor Applications

U.S. Letter Sheet Format (8.5" x 11" / 215.9 mm x 279.4 mm)

Part Number	Material	Print-On Area Color	Label Size Width x Length In. (mm)	Print-On Area Width x Length In. (mm)	Nominal Cable Outside Diameter * In. (mm)	Dwg. Page No.	Std. Pkg. Qty.*
PLL-3-Y3-5	GMY3-C Self-Laminating Polyester	White	0.50 x 0.75 (12.7 x 19.1)	0.50 x 0.34 (12.7 x 8.64)	0.11 - 0.13 (2.7 - 3.3)	70	5000
PLL-33-Y3-5		White	0.50 x 1.50 (12.7 x 38.1)	0.50 x 0.50 (12.7 x 12.7)			
PLL-10-Y3-2.5		White	1.00 x 0.75 (25.4 x 19.1)	1.00 x 0.34 (25.4 x 8.64)	0.11 - 0.13 (2.7 - 3.3)	70	2500
PLL-10-Y3-5		White	1.00 x 0.75 (25.4 x 19.1)	1.00 x 0.34 (25.4 x 8.64)			
PLL-11-Y3-2.5†		White	1.00 x 1.00 (25.4 x 25.4)	1.00 x 0.34 (25.4 x 8.64)	0.11 - 0.21 (2.7 x 5.3)	70	2500
PLL-12-Y3-1		White	1.00 x 1.33 (25.4 x 33.8)	1.00 x 0.50 (25.4 x 12.7)			
PLL-12-Y3-2.5†		White	1.00 x 1.33 (25.4 x 33.8)	1.00 x 0.50 (25.4 x 12.7)	0.16 - 0.26 (4.0 - 6.7)	70	1000
PLL-39-Y3-1		White	1.00 x 1.33 (25.4 x 33.8)	1.00 x 0.50 (25.4 x 12.7)			
PLL-13-Y3-D		White	1.00 x 3.17 (25.4 x 80.5)	1.00 x 0.97 (25.4 x 24.6)	0.31 - 0.70 (7.8 - 17.8)	70	500
PLL-13-Y3-1		White	1.00 x 3.17 (25.4 x 80.5)	1.00 x 0.97 (25.4 x 24.6)			
PLL-38-Y3-1		White	1.00 x 5.45 (25.4 x 138.4)	1.00 x 1.00 (25.4 x 25.4)	0.32 - 1.42 (8.1 - 36.1)	70	1000
PLL-37-Y3-1		White	1.88 x 3.17 (47.6 x 80.5)	1.88 x 0.97 (47.6 x 24.6)			
PLL-40-Y3-1		White	2.00 x 1.50 (50.8 x 38.1)	2.00 x 0.50 (50.8 x 12.7)	0.16 - 0.32 (4.0 - 8.1)	70	1000
PLL-21-Y3-1		White	2.00 x 3.17 (50.8 x 80.5)	2.00 x 1.00 (50.8 x 25.4)			

*Refer to Wire Size Selection Guide on page 196 to review diameters of commonly used cables

†Labels available with TIA Specified Colored Print-On Area; to order, add the following letters after-Y3 in the part number: B for Blue, BR for Brown, G for Green, IG for Gray, OR for Orange, PR for Purple, RD for Red and Y for Yellow. i.e. PLL-11-Y3B-2.5 has a Blue Print-On Area.

Self-Laminating Labels by Material (cont.)

Clear Polyester – Indoor/Outdoor Applications (cont.)

DIN A4 Sheet Format (8.26" x 11.69" / 210 mm x 297 mm)

Part Number	Material	Print-On Area Color	Label Size Width x Length In. (mm)	Print-On Area Width x Length In. (mm)	Nominal Cable Outside Diameter* In. (mm)	Dwg. Page No.	Std. Pkg. Qty.*
PEL-17-Y3-2.5†	GMY3-C Self-Laminating Polyester	White	0.70 x 1.33 (17.8 x 33.9)	0.70 x 0.33 (17.8 x 8.5)	0.11 - 0.32 (2.8 - 8.1)	71	2500
PEL-18-Y3-1†		White	0.90 x 2.17 (22.9 x 55.0)	0.90 x 0.50 (22.9 x 12.7)	0.16 - 0.53 (4.1 - 13.5)	71	1000
PEL-19-Y3-1†		White	1.00 x 2.67 (25.4 x 67.7)	1.00 x 0.67 (25.4 x 16.9)	0.21 - 0.64 (5.3 - 16.2)	71	1000
PEL-20-Y3-1		White	1.20 x 2.67 (30.5 x 67.7)	1.20 x 0.83 (30.5 x 21.1)	0.26 - 0.58 (6.6 - 14.7)	71	1000
PEL-21-Y3-0.5†		White	1.40 x 3.67 (35.6 x 93.1)	1.40 x 1.00 (35.6 x 25.4)	0.32 - 0.85 (8.1 - 21.6)	71	500
PEL-22-Y3-0.5		White	1.40 x 5.50 (35.6 x 140.0)	1.40 x 1.00 (35.6 x 25.4)	0.32 - 1.40 (8.1 - 35.6)	71	500
PEL-23-Y3-0.5		White	1.80 x 5.50 (45.7 x 140.0)	1.80 x 1.167 (45.7 x 29.6)	0.37 - 1.38 (9.4 - 35.0)	71	500

*Refer to Wire Size Selection Guide on page 196 to review diameters of commonly used cables

†Labels available with TIA Specified Colored Print-On Areas; to order replace -Y3 with -BLU for Blue, -BRN for Brown, -GRN for Green, -GRY for Gray, -ORN for Orange, -PUR for Purple, -RED for Red, and -YEL for Yellow. i.e. PEL-17-BLU-2.5 has a Blue Print-On Area.

Clear Polyolefin – Indoor Applications

DIN A4 Sheet Format (8.26" x 11.69" / 210 mm x 297 mm)

Part Number	Material	Print-On Area Color	Label Size Width x Length In. (mm)	Print-On Area Width x Length In. (mm)	Nominal Cable Outside Diameter* In. (mm)	Dwg. Page No.	Std. Pkg. Qty.*
PEL-18-PO3-1	GMPO Polyolefin	White	0.90 x 2.17 (22.9 x 55.0)	0.90 x 0.50 (22.9 x 12.7)	0.16 - 0.53 (4.1 - 13.5)	71	1000

*Refer to Wire Size Selection Guide on page 196 to review diameters of commonly used cables

Blank Labels by Material



- Non-laminated material used in indoor applications
- Permanent adhesive
- Excellent print quality, limited resistance to solvents and oil

Polyolefin - Indoor Applications

U.S. Letter Sheet Format (8.5" x 11" / 215.9 mm x 279.4 mm)

Part Number	Material	Color	Label Size Width x Length In. (mm)	Dwg. Page No.	Std. Pkg. Qty.*
PLL-33-PO-5	GMPO Polyolefin	White	0.50 x 1.50 (12.7 x 38.1)	72	5000
PLL-8-PO-10			1.00 x 0.38 (25.4 x 9.5)	72	10,000
PLL-10-PO-5			1.00 x 0.75 (25.4 x 19.1)	73	5000
PLL-14-PO-5			1.50 x 0.25 (38.1 x 6.4)	73	5000
PLL-35-PO-2.5			1.50 x 0.75 (38.1 x 19.1)	73	2500
PLL-16-PO-2.5			1.88 x 0.38 (47.6 x 9.5)	73	2500
PLL-17-PO-2.5			1.88 x 0.83 (47.6 x 21.1)	74	2500
PLL-36-PO-1			2.50 x 1.00 (63.5 x 25.4)	74	1000
PLL-22-PO-1†			7.88 x 0.50 (200.0 x 12.7)	74	1000
PLL-25-PO-SH			8.50 x 11.00 (215.9 x 279.4)	74	25

†Labels available in colors; to order add the following suffix to part number: -Y for Yellow, -R for Red, -B for Blue, -G for Green, -GR for Gray, -PR for Purple and -BR for Brown



- Used for temporary identification

Removable Polyolefin - Indoor Applications

U.S. Letter Sheet Format (8.5" x 11" / 215.9 mm x 279.4 mm)

Part Number	Material	Color	Label Size Width x Length In. (mm)	Dwg. Page No.	Std. Pkg. Qty.*
PLL-31-POR-10	GMPOR Removable Polyolefin	White	0.50 x 0.44 (12.7 x 11.1)	72	10,000
PLL-9-POR-10			1.00 x 0.50 (25.4 x 12.7)	73	10,000
PLL-34-POR-10			1.25 x 0.38 (31.8 x 9.5)	73	10,000
PLL-14-POR-5			1.50 x 0.25 (38.1 x 6.4)	73	5000
PLL-35-POR-2.5			1.50 x 0.75 (38.1 x 19.1)	73	2500
PLL-36-POR-1			2.50 x 1.00 (63.5 x 25.4)	74	1000
PLL-19-POR-2.5			3.00 x 0.38 (76.2 x 9.5)	74	2500
PLL-25-POR-SH			8.50 x 11.00 (215.9 x 279.4)	74	25

*Order number of labels required in multiples of Std. Pkg. Qty.

Blank Labels by Material (cont.)



- Used for shipping or labeling
- Excellent black/white contrast for bar code applications
- Most economical labeling solution

Litho Paper - Indoor/Temporary Applications

U.S. Letter Sheet Format (8.5" x 11" / 215.9 mm x 279.4 mm)

Part Number	Material	Color	Label Size Width x Length In. (mm)	Dwg. Page No.	Sheets Per Pkg.	Std. Pkg. Qty.*
LL2561-100G	Litho Paper	White	2.83 x 1.00 (72.0 x 25.4)	75	100	1 Pkg.
LL2561-100			2.83 x 1.00 (72.0 x 25.4)	75	100	1 Pkg.
LL2561-250			2.83 x 1.00 (72.0 x 25.4)	75	250	1 Pkg.
LL2561-500			2.83 x 1.00 (72.0 x 25.4)	75	500	1 Pkg.
LL256138-100			2.83 x 1.38 (72.0 x 34.9)	75	100	1 Pkg.
LL25615-100G			2.83 x 1.50 (72.0 x 38.1)	75	100	1 Pkg.
LL4252-100G			4.25 x 2.00 (108.0 x 50.8)	75	100	1 Pkg.
LL425275-250			4.25 x 2.00 (108.0 x 50.8)	75	250	1 Pkg.
LL42513-100G			4.25 x 13.00 (108.0 x 330.2)	75	100	1 Pkg.
LL8511-100			8.50 x 11.00 (215.9 x 279.4)	75	100	1 Pkg.

*Order number of packages required in multiples of Std. Pkg. Qty.

- Use on colored or clear surfaces
- Durable polyester material is UV and temperature resistant
- Apply to flat, clean surfaces only

Clear Polyester - Indoor/Outdoor Applications

U.S. Letter Sheet Format (8.5" x 11" / 215.9 mm x 279.4 mm)

Part Number	Material	Color	Label Size Width x Length In. (mm)	Dwg. Page No.	Std. Pkg. Qty.*
PLL-24-Y3-1	GMY3 Polyester	Clear	0.56 x 0.19 (14.3 x 4.8)	72	1000
PLL-24-Y3-5			0.56 x 0.19 (14.3 x 4.8)	72	5000
PLL-23-Y3-1			0.56 x 0.56 (14.3 x 14.3)	72	1000
PLL-23-Y3-5			0.56 x 0.56 (14.3 x 14.3)	72	5000
PLL-9-Y3C-5			1.00 x 0.50 (25.4 x 12.7)	73	5000
PLL-10-Y3C-2.5			1.00 x 0.75 (25.4 x 19.1)	73	2500
PLL-11-Y3C-2.5			1.00 x 1.00 (25.4 x 25.4)	73	2500
PLL-22-Y3-1			7.88 x 0.50 (200.0 x 12.7)	74	1000
PLL-25-Y3C-SH			8.50 x 11.00 (215.9 x 279.4)	74	25

*Order number of labels required in multiples of Std. Pkg. Qty.

DIN A4 Sheet Format (8.26" x 11.69" / 210 mm x 297 mm)

Part Number	Material	Color	Label Size Width x Length In. (mm)	Dwg. Page No.	Std. Pkg. Qty.*
PEL-A4-Y3-25	GMY3 Polyester	Clear	8.27 x 11.69 (210.0 x 297.0)	77	25

*Order number of labels required in multiples of Std. Pkg. Qty.

- Matte clear finish
- Use on colored or clear surfaces
- Durable polyester material is UV and temperature resistant
- Apply to flat, clean surfaces only

Matte Clear Polyester - Indoor/Outdoor Applications

DIN A4 Sheet Format (8.26" x 11.69" / 210 mm x 297 mm)

Part Number	Material	Color	Label Size Width x Length In. (mm)	Dwg. Page No.	Std. Pkg. Qty.*
PEL-29-Y3M-10	GMY3M Polyester	Matte Clear	0.56 x 0.25 (14.3 x 6.4)	76	10,000
PEL-28-Y3M-5			0.56 x 0.56 (14.3 x 14.3)	76	5000
PEL-10-Y3M-5			0.70 x 0.50 (17.8 x 12.7)	76	5000
PEL-2-Y3M-10			1.00 x 0.25 (25.4 x 6.4)	76	10,000
PEL-7-Y3M-5			1.50 x 0.33 (38.1 x 8.5)	77	5000
PEL-A4-Y3M-25			8.27 x 11.69 (210.0 x 297.0)	77	25

*Order number of labels required in multiples of Std. Pkg. Qty.

Blank Labels by Material (cont.)



- Adhesive becomes permanent after 24 hours
- Durable polyester, ideal for the top of circuit boards
- Can be used (on top) before wave solder process
- UV resistant for outdoor applications
- Apply to flat, clean surfaces only

White Polyester - Indoor/Outdoor Applications

U.S. Letter Sheet Format (8.5" x 11" / 215.9 mm x 279.4 mm)

Part Number	Material	Color	Label Size Width x Length In. (mm)	Dwg. Page No.	Std. Pkg. Qty.*
PLL-30-Y2-10	GMY2-W Polyester	White	0.25 x 0.25 (6.4 x 6.4)	75	10,000
PLL-1-Y2-10			0.30 x 0.25 (7.6 x 6.4)	75	10,000
PLL-2-Y2-10			0.38 x 0.38 (9.5 x 9.5)	72	10,000
PLL-31-Y2-10			0.50 x 0.44 (12.7 x 11.1)	72	10,000
PLL-24-Y2-1			0.56 x 0.19 (14.3 x 4.8)	72	1000
PLL-24-Y2-5			0.56 x 0.19 (14.3 x 4.8)	72	5000
PLL-23-Y2-1			0.56 x 0.56 (14.3 x 14.3)	72	1000
PLL-23-Y2-5			0.56 x 0.56 (14.3 x 14.3)	72	5000
PLL-32-Y2-10			0.65 x 0.20 (16.5 x 5.1)	72	10,000
PLL-4-Y2-10			0.65 x 0.25 (16.5 x 6.4)	72	10,000
PLL-20-Y2-10			0.80 x 0.20 (20.3 x 5.1)	72	10,000
PLL-5-Y2-10			0.80 x 0.25 (20.3 x 6.4)	72	10,000
PLL-6-Y2-5			0.80 x 0.50 (20.3 x 12.7)	72	5000
PLL-6-Y2-10			0.80 x 0.50 (20.3 x 12.7)	72	10,000
PLL-7-Y2-10			1.00 x 0.25 (25.4 x 6.4)	72	10,000
PLL-8-Y2-5			1.00 x 0.38 (25.4 x 9.5)	72	5000
PLL-8-Y2-10			1.00 x 0.38 (25.4 x 9.5)	72	10,000
PLL-9-Y2-5			1.00 x 0.50 (25.4 x 12.7)	73	5000
PLL-9-Y2-10			1.00 x 0.50 (25.4 x 12.7)	72	10,000
PLL-10-Y2-2.5			1.00 x 0.75 (25.4 x 19.1)	73	2500
PLL-11-Y2-2.5			1.00 x 1.00 (25.4 x 25.4)	73	2500
PLL-12-Y2-1			1.00 x 1.33 (25.4 x 33.8)	73	1000
PLL-12-Y2-2.5			1.00 x 1.33 (25.4 x 33.8)	73	2500
PLL-34-Y2-10			1.25 x 0.38 (31.8 x 9.5)	73	10,000
PLL-14-Y2-5			1.50 x 0.25 (38.1 x 6.4)	73	5000
PLL-14-Y2-10			1.50 x 0.25 (38.1 x 6.4)	73	10,000
PLL-15-Y2-5			1.88 x 0.25 (47.6 x 6.4)	73	5000
PLL-15-Y2-10			1.88 x 0.25 (47.6 x 6.4)	73	10,000
PLL-16-Y2-2.5			1.88 x 0.38 (47.6 x 9.5)	73	2500
PLL-16-Y2-5			1.88 x 0.38 (47.6 x 9.5)	73	5000
PLL-17-Y2-1			1.88 x 0.83 (47.6 x 21.1)	73	1000
PLL-17-Y2-2.5			1.88 x 0.83 (47.6 x 21.1)	73	2500
PLL-18-Y2-1			1.88 x 1.33 (47.6 x 33.8)	74	1000
PLL-18-Y2-1.5			1.88 x 1.33 (47.6 x 33.8)	74	1500
PLL-36-Y2-1	2.50 x 1.00 (63.5 x 25.4)	74	1000		
PLL-26-Y2-1	2.83 x 1.00 (72.0 x 25.4)	74	1000		
PLL-27-Y2-1	2.83 x 1.38 (72.0 x 34.9)	74	1000		
PLL-28-Y2-1	2.83 x 1.50 (72.0 x 38.1)	74	1000		
PLL-19-Y2-1	3.00 x 0.38 (76.2 x 9.5)	74	1000		
PLL-19-Y2-2.5	3.00 x 0.38 (76.2 x 9.5)	74	2500		
PLL-29-Y2-1	4.25 x 2.00 (108.0 x 50.8)	74	1000		
PLL-22-Y2-1	7.88 x 0.50 (200.0 x 12.7)	74	1000		
PLL-25-Y2-SH	8.50 x 11.00 (215.9 x 279.4)	74	25		

*Order number of labels required in multiples of Std. Pkg. Qty.

Blank Labels by Material (cont.)



- Adhesive becomes permanent after 24 hours
- Durable polyester, ideal for the top of circuit boards
- Can be used (on top) before wave solder process
- UV resistant for outdoor applications
- Apply to flat, clean surfaces only

White Polyester - Indoor/Outdoor Applications (cont.)

DIN A4 Sheet Format (8.26" x 11.69" / 210 mm x 297 mm)

Part Number	Material	Color	Label Size Width x Length In. (mm)	Dwg. Page No.	Std. Pkg. Qty.*
PEL-9-Y2-10	GMY2-W Polyester	White	0.50 x 0.50 (12.7 x 12.7)	76	10,000
PEL-29-Y2-10			0.56 x 0.25 (14.3 x 6.4)	76	10,000
PEL-28-Y2-5			0.56 x 0.56 (14.3 x 14.3)	76	5000
PEL-1-Y2-10			0.70 x 0.25 (17.8 x 6.4)	76	10,000
PEL-4-Y2-10			0.70 x 0.33 (17.8 x 8.5)	76	10,000
PEL-10-Y2-5			0.70 x 0.50 (17.8 x 12.7)	76	5000
PEL-5-Y2-10			0.80 x 0.33 (20.3 x 8.5)	76	10,000
PEL-2-Y2-10			1.00 x 0.25 (25.4 x 6.4)	76	10,000
PEL-6-Y2-5			1.00 x 0.33 (25.4 x 8.5)	76	5000
PEL-11-Y2-5			1.00 x 0.50 (25.4 x 12.7)	76	5000
PEL-3-Y2-5			1.44 x 0.25 (36.5 x 6.4)	77	5000
PEL-7-Y2-5			1.50 x 0.33 (38.1 x 8.5)	77	5000
PEL-12-Y2-2.5			1.50 x 0.50 (38.1 x 12.7)	77	2500
PEL-8-Y2-2.5			2.00 x 0.33 (50.8 x 8.5)	77	2500
PEL-13-Y2-2.5			2.00 x 0.50 (50.8 x 12.7)	77	2500
PEL-14-Y2-1			2.00 x 0.83 (50.8 x 21.1)	77	1000
PEL-15-Y2-1			2.00 x 1.00 (50.8 x 25.4)	77	1000
PEL-16-Y2-0.5			2.50 x 1.33 (63.5 x 33.9)	77	500
PEL-A4-Y2-25			8.27 x 11.69 (210.0 x 297.0)	77	25



- Adhesive becomes permanent after 24 hours
- Durable polyester, ideal for the top of circuit boards
- Can be used (on top) before wave solder process
- UV resistant for outdoor applications
- Apply to flat, clean surfaces only

Yellow Polyester - Indoor/Outdoor Applications

U.S. Letter Sheet Format (8.5" x 11" / 215.9 mm x 279.4 mm)

Part Number	Material	Color	Label Size Width x Length In. (mm)	Dwg. Page No.	Std. Pkg. Qty.*
PLL-1-Y2Y-10	GMY2-Y Polyester	Yellow	0.30 x 0.25 (7.6 x 6.4)	75	10,000
PLL-2-Y2Y-10			0.38 x 0.38 (9.5 x 9.5)	72	10,000
PLL-32-Y2Y-10			0.65 x 0.20 (16.5 x 5.1)	72	10,000
PLL-4-Y2Y-10			0.65 x 0.25 (16.5 x 6.4)	72	10,000
PLL-20-Y2Y-10			0.80 x 0.20 (20.3 x 5.1)	72	10,000
PLL-5-Y2Y-10			0.80 x 0.25 (20.3 x 6.4)	72	10,000
PLL-6-Y2Y-5			0.80 x 0.50 (20.3 x 12.7)	72	5000
PLL-6-Y2Y-10			0.80 x 0.50 (20.3 x 12.7)	72	10,000
PLL-7-Y2Y-10			1.00 x 0.25 (25.4 x 6.4)	72	10,000
PLL-8-Y2Y-5			1.00 x 0.38 (25.4 x 9.5)	72	5000
PLL-8-Y2Y-10			1.00 x 0.38 (25.4 x 9.5)	72	10,000
PLL-9-Y2Y-5			1.00 x 0.50 (25.4 x 12.7)	73	5000
PLL-9-Y2Y-10			1.00 x 0.50 (25.4 x 12.7)	73	10,000
PLL-34-Y2Y-10			1.25 x 0.38 (31.8 x 9.5)	73	10,000
PLL-14-Y2Y-5			1.50 x 0.25 (38.1 x 6.4)	73	5000
PLL-15-Y2Y-5			1.88 x 0.25 (47.6 x 6.4)	73	5000
PLL-16-Y2Y-2.5			1.88 x 0.38 (47.6 x 9.5)	73	2500
PLL-16-Y2Y-5			1.88 x 0.38 (47.6 x 9.5)	73	5000
PLL-17-Y2Y-2.5			1.88 x 0.83 (47.6 x 21.1)	73	2500
PLL-18-Y2Y-1			1.88 x 1.33 (47.6 x 33.8)	74	1000
PLL-18-Y2Y-1.5			1.88 x 1.33 (47.6 x 33.8)	74	1500
PLL-19-Y2Y-1			3.00 x 0.38 (76.2 x 9.5)	74	1000
PLL-19-Y2Y-2.5			3.00 x 0.38 (76.2 x 9.5)	74	2500
PLL-25-Y2Y-SH			8.50 x 11.00 (215.9 x 279.4)	74	25

Blank Labels by Material (cont.)



- Adhesive becomes permanent after 24 hours
- Durable polyester, ideal for the top of circuit boards
- UV resistant for outdoor applications
- Apply to flat, clean surfaces only

Yellow Polyester - Indoor/Outdoor Applications (cont.)

DIN A4 Sheet Format (8.26" x 11.69" / 210 mm x 297 mm)

Part Number	Material	Color	Label Size Width x Length In. (mm)	Dwg. Page No.	Std. Pkg. Qty.*
PEL-25-Y2Y-10	GMY2-Y Polyester	Yellow	0.35 x 0.59 (9.0 x 15.0)	76	10,000
PEL-26-Y2Y-5			0.43 x 0.75 (11.0 x 19.1)	76	5000
PEL-27-Y2Y-5			0.43 x 1.50 (11.0 x 38.1)	76	5000
PEL-4-Y2Y-10			0.70 x 0.33 (17.8 x 8.5)	76	10,000
PEL-10-Y2Y-5			0.70 x 0.50 (17.8 x 12.7)	76	5000
PEL-24-Y2Y-10			0.79 x 0.31 (20.0 x 8.0)	76	10,000
PEL-5-Y2Y-10			0.80 x 0.33 (20.3 x 8.5)	76	10,000
PEL-2-Y2Y-10			1.00 x 0.25 (25.4 x 6.4)	76	10,000
PEL-11-Y2Y-5			1.00 x 0.50 (25.4 x 12.7)	76	5000
PEL-7-Y2Y-5			1.50 x 0.33 (38.1 x 8.5)	77	5000
PEL-12-Y2Y-2.5			1.50 x 0.50 (38.1 x 12.7)	77	2500
PEL-15-Y2Y-1			2.00 x 1.00 (50.8 x 25.4)	77	1000
PEL-A4-Y2Y-25			8.27 x 11.69 (210.0 x 297.0)	77	25



- Warning sign, reference EIA (Electronic Industries Assoc) Standard RS-471 and MIL Standard 129J

Static Sensitive Label

DIN A4 Sheet Format (8.26" x 11.69" / 210 mm x 297 mm)

Part Number	Material	Color	Label Size Width x Length In. (mm)	Printable Area Width x Length In. (mm)	Dwg. Page No.	Std. Pkg. Qty.*
PESS-SEL	GMY2-Y Polyester	Yellow	1.00 x 0.50 (25.4 x 12.7)	1.00 x 0.25 (25.4 x 6.4)	76	2500

Silver Polyester - Indoor/Outdoor Applications

U.S. Letter Sheet Format (8.5" x 11" / 215.9 mm x 279.4 mm)



- UV opaque material used to cover EPROM windows
- Adhesive becomes permanent after 24 hours
- Durable polyester, ideal for the top of circuit boards
- Can be used (on top) before wave solder process
- UV resistant for outdoor applications
- Apply to flat, clean surfaces only

Part Number	Material	Color	Label Size Width x Length In. (mm)	Dwg. Page No.	Std. Pkg. Qty.*
PLL-9-Y2S-10	GMY2-S Polyester	Silver	1.00 x 0.50 (25.4 x 12.7)	73	10,000
PLL-35-Y2S-2.5			1.50 x 0.75 (38.1 x 19.1)	73	2500
PLL-36-Y2S-1			2.50 x 1.00 (63.5 x 25.4)	74	1000
PLL-25-Y2S-SH			8.50 x 11.00 (215.9 x 279.4)	74	25

DIN A4 Sheet Format (8.26" x 11.69" / 210 mm x 297 mm)

Part Number	Material	Color	Label Size Width x Length In. (mm)	Dwg. Page No.	Std. Pkg. Qty.*
PEL-9-Y1-10	GMY2-S Polyester	Silver	0.50 x 0.50 (12.7 x 12.7)	76	10,000
PEL-1-Y1-10			0.70 x 0.25 (17.8 x 6.4)	76	10,000
PEL-4-Y1-10			0.70 x 0.33 (17.8 x 8.5)	76	10,000
PEL-10-Y1-5			0.70 x 0.50 (17.8 x 12.7)	76	5000
PEL-5-Y1-10			0.80 x 0.33 (20.3 x 8.5)	76	10,000
PEL-2-Y1-10			1.00 x 0.25 (25.4 x 6.4)	76	10,000
PEL-6-Y1-5			1.00 x 0.33 (25.4 x 8.5)	76	5000
PEL-11-Y1-5			1.00 x 0.50 (25.4 x 12.7)	76	5000
PEL-3-Y1-5			1.44 x 0.25 (36.5 x 6.4)	77	5000
PEL-7-Y1-5			1.50 x 0.33 (38.1 x 8.5)	77	5000
PEL-12-Y1-2.5			1.50 x 0.50 (38.1 x 12.7)	77	2500
PEL-8-Y1-2.5			2.00 x 0.33 (50.8 x 8.5)	77	2500
PEL-13-Y1-2.5			2.00 x 0.50 (50.8 x 12.7)	77	2500
PEL-14-Y1-1			2.00 x 0.83 (50.8 x 21.1)	77	1000
PEL-15-Y1-1			2.00 x 1.00 (50.8 x 25.4)	77	1000
PEL-16-Y1-0.5			2.50 x 1.33 (63.5 x 33.9)	77	500
PEL-A4-Y1-25			8.27 x 11.69 (210.0 x 297.0)	77	25

*Order number of labels required in multiples of Std. Pkg. Qty.

Blank Labels by Material (cont.)



- For tamper evident applications

Tamper Evident Polyester - Indoor/Outdoor Applications

DIN A4 Sheet Format (8.26" x 11.69" / 210 mm x 297 mm)

Part Number	Material	Color	Label Size Width x Length In. (mm)	Dwg. Page No.	Std. Pkg. Qty.*
PEL-9-Y1C-10	GMY2-STE Tamper Evident Polyester	Silver	0.50 x 0.50 (12.7 x 12.7)	76	10,000
PEL-4-Y1C-10			0.70 x 0.33 (17.8 x 8.5)	76	10,000
PEL-6-Y1C-5			1.00 x 0.33 (25.4 x 8.5)	76	5000
PEL-11-Y1C-5			1.00 x 0.50 (25.4 x 12.7)	76	5000
PEL-3-Y1C-5			1.40 x 0.25 (36.5 x 6.4)	77	5000
PEL-8-Y1C-2.5			2.00 x 0.33 (50.8 x 8.5)	77	2500
PEL-15-Y1C-1			2.00 x 1.00 (50.8 x 25.4)	77	1000
PEL-16-Y1C-0.5			2.50 x 1.33 (63.5 x 33.9)	77	500
PEL-A4-Y1C-25			8.27 x 11.69 (210.0 x 297.0)	77	25



Full Sheets

- Used for a wide variety of applications
- Full size sheets are available in 7 materials suitable for laser printing
- Ideal for prototyping and low volume custom labeling
- Custom large or irregular label sizes

U.S. Letter Sheet Format (8.5" x 11" / 215.9 mm x 279.4 mm)

Part Number	Material	Color	Label Size Width x Length In. (mm)	Dwg. Page No.	Std. Pkg. Qty.*
PLL-25-PO-SH	GMPO Polyolefin	White	8.50 x 11.00 (215.9 x 279.4)	74	25
PLL-25-Y2S-SH	GMY2-S Polyester	Silver	8.50 x 11.00 (215.9 x 279.4)	74	25
PLL-25-Y3C-SH	GMY3-C Polyester	Clear	8.50 x 11.00 (215.9 x 279.4)	74	25
PLL-25-Y2-SH	GMY2-W Polyester	White	8.50 x 11.00 (215.9 x 279.4)	74	25
PLL-25-POR-SH	GMPOR Rem. Polyolefin	White	8.50 x 11.00 (215.9 x 279.4)	74	25
PLL-25-Y2Y-SH	GMY2-Y Polyester	Yellow	8.50 x 11.00 (215.9 x 279.4)	74	25

DIN A4 Sheet Format (8.26" x 11.69" / 210 mm x 297 mm)

Part Number	Material	Color	Label Size Width x Length In. (mm)	Dwg. Page No.	Std. Pkg. Qty.*
PEL-A4-Y3-25	GMY3-C Polyester	Clear	8.27 x 11.69 (210.0 x 297.0)	77	25
PEL-A4-Y3M-25	GMY3M Polyester	Matte Clear	8.27 x 11.69 (210.0 x 297.0)	77	25
PEL-A4-Y1-25	GMY2-S Polyester	Silver	8.27 x 11.69 (210.0 x 297.0)	77	25
PEL-A4-Y2-25	GMY2-W Polyester	White	8.27 x 11.69 (210.0 x 297.0)	77	25
PEL-A4-Y2Y-25	GMY2-Y Polyester	Yellow	8.27 x 11.69 (210.0 x 297.0)	77	25
PEL-A4-Y1C-25	GMY2-STE Tamper Evident Polyester	Silver	8.27 x 11.69 (210.0 x 297.0)	77	25

TIA/EIA-606 Compliant Network Systems Labeling



What is TIA/EIA-606?

TIA/EIA-606 is a standard from the Telecommunications Industry Association which requires labeling and administration of the telecommunication infrastructure in commercial buildings. TIA-606 applies to Cables, Connectors, Hub Facilities, Termination Facilities (Patch Panels), Conduits and Pathways.

Panduit manufactures a broad range of labeling products to help you conform to TIA/EIA-606.

Along with the labels already shown in this section, the following pages feature labels designed specifically for Network Systems Labeling. Many of these labels can be used with Dot-Matrix and Laser Printers.

*For more information on the complete line of **PAN-NET™** Network Cabling System Products, ask for the Communication Products Catalog.*

Termination Hardware Labeling



Adhesive 110 Block Labels

Designed to work in Laser Printers Only

Part Number	Material	TIA Color	Label Width In. (mm)	Label Length In. (mm)	Vertical Repeat In. (mm)	No. of Col.	No. of Rows	Labels Per Sheet	Std. Pkg. Qty.*	
PLL-22-Y3-1	GMYP3 Polyester	Clear	7.88 (200.0)	0.50 (12.7)	0.50 (12.7)	1	20	20	1000	
PLL-22-P0-1	GMPO Polyolefin	White	7.88 (200.0)	0.50 (12.7)	0.50 (12.7)	1	20	20	1000	
PLL-22-P0-1B		Blue	7.88 (200.0)	0.50 (12.7)	0.50 (12.7)	1	20	20	1000	
PLL-22-P0-1BR		Brown	7.88 (200.0)	0.50 (12.7)	0.50 (12.7)	1	20	20	1000	
PLL-22-P0-1G		Green	7.88 (200.0)	0.50 (12.7)	0.50 (12.7)	1	20	20	1000	
PLL-22-P0-1GR		Gray	7.88 (200.0)	0.50 (12.7)	0.50 (12.7)	1	20	20	1000	
PLL-22-P0-1OR		Orange	7.88 (200.0)	0.50 (12.7)	0.50 (12.7)	1	20	20	1000	
PLL-22-P0-1PR		Purple	7.88 (200.0)	0.50 (12.7)	0.50 (12.7)	1	20	20	1000	
PLL-22-P0-1R		Red	7.88 (200.0)	0.50 (12.7)	0.50 (12.7)	1	20	20	1000	
PLL-22-P0-1Y		Yellow	7.88 (200.0)	0.50 (12.7)	0.50 (12.7)	0.50 (12.7)	1	20	20	1000

Adhesive Labels

- Eliminate the need for standard paper designation strips
- Labels are placed on top of label holders



Non-Adhesive 110 Punch Down Block Labels

Designed to work in Laser and Dot-Matrix Printers

Part Number	Material	Color	Label Width In. (mm)	Label Length In. (mm)	Vertical Repeat In. (mm)	Labels Per Row	Rows Per Fanfold	Web Width In. (mm)	Std. Pkg. Qty.*	
DS110	Semi-Rigid Paper	White	7.88 (200.0)	0.50 (12.7)	0.50 (12.7)	1	15	8.50 (215.9)	150	
DS110-BR		Brown	7.88 (200.0)	0.50 (12.7)	0.50 (12.7)	1	15	8.50 (215.9)	150	
DS110-BU		Blue	7.88 (200.0)	0.50 (12.7)	0.50 (12.7)	1	15	8.50 (215.9)	150	
DS110-GR		Green	7.88 (200.0)	0.50 (12.7)	0.50 (12.7)	1	15	8.50 (215.9)	150	
DS110-IG		Gray	7.88 (200.0)	0.50 (12.7)	0.50 (12.7)	1	15	8.50 (215.9)	150	
DS110-OR		Orange	7.88 (200.0)	0.50 (12.7)	0.50 (12.7)	1	15	8.50 (215.9)	150	
DS110-RD		Red	7.88 (200.0)	0.50 (12.7)	0.50 (12.7)	1	15	8.50 (215.9)	150	
DS110-VL		Violet	7.88 (200.0)	0.50 (12.7)	0.50 (12.7)	1	15	8.50 (215.9)	150	
DS110-YL		Yellow	7.88 (200.0)	0.50 (12.7)	0.50 (12.7)	0.50 (12.7)	1	15	8.50 (215.9)	150

Non-Adhesive Labels

- To use with Laser Printer, simply tear sheets apart at fanfold perforation and use manual feed supply on printer

*Order number of labels required in multiples of Std. Pkg. Qty.

Network Systems Labeling — Termination Hardware (cont.)



Adhesive Label for Patch Panels and Modular Furniture Faceplates

- Label is perforated on black lines to be used in 2 position, 4 position, or 6 position applications

Designed to work in Laser and Dot-Matrix Printers

Part Number	Material	Color	Label Width In. (mm)	Label Length In. (mm)	Horizontal Repeat In. (mm)	Vertical Repeat In. (mm)	No. of Col.	No. of Rows	Labels Per Sheet	Std. Pkg. Qty.*
CPPLF-5	GMPO Polyolefin	White	0.61 (15.5)	0.33 (8.4)	0.61 (15.5)	0.33 (8.4)	12	25	300	5000
CPPLF-5BU		Blue	0.61 (15.5)	0.33 (8.4)	0.61 (15.5)	0.33 (8.4)	12	25	300	5000
CPPLF-5EI		Ivory	0.61 (15.5)	0.33 (8.4)	0.61 (15.5)	0.33 (8.4)	12	25	300	5000
CPPLF-5GR		Green	0.61 (15.5)	0.33 (8.4)	0.61 (15.5)	0.33 (8.4)	12	25	300	5000
CPPLF-5IG		Gray	0.61 (15.5)	0.33 (8.4)	0.61 (15.5)	0.33 (8.4)	12	25	300	5000
CPPLF-5OR		Orange	0.61 (15.5)	0.33 (8.4)	0.61 (15.5)	0.33 (8.4)	12	25	300	5000
CPPLF-5VL		Violet	0.61 (15.5)	0.33 (8.4)	0.61 (15.5)	0.33 (8.4)	12	25	300	5000
CPPLF-5RD		Red	0.61 (15.5)	0.33 (8.4)	0.61 (15.5)	0.33 (8.4)	12	25	300	5000
CPPLF-5YL		Yellow	0.61 (15.5)	0.33 (8.4)	0.61 (15.5)	0.33 (8.4)	12	25	300	5000

Termination Position Labeling



MINI-JACK™ Modular Jack and OPTI-JACK™ Fiber Optic Connector Labels



- Identify individual jacks and connectors
- Wrap around design allows for quick and secure installation
- Labels attach directly to jacks

Part Number	Material	Color	Label Width In. (mm)	Label Length In. (mm)	Horizontal Repeat In. (mm)	Vertical Repeat In. (mm)	No. of Col.	No. of Rows	Labels Per Sheet	Std. Pkg. Qty.*
PLL-46-Y3C-1	GMYP3 Polyester	Clear	1.38 (34.9)	0.19 (4.8)	1.53 (38.9)	0.19 (4.8)	5	53	265	1000
PLL-46-Y2-1	GMYP2 Polyester	White	1.38 (34.9)	0.19 (4.8)	1.53 (38.9)	0.19 (4.8)	5	53	265	1000



Surface Mount Box Labels

U.S. Letter Sheet Format (8.5" x 11" / 215.9 mm x 279.4 mm)

Part Number	Material	Color	Label Size Width x Length In. (mm)	Dwg. Page No.	Std. Pkg. Qty.*
PLL-23-Y3-1	GMYP-C Polyester	Clear	0.56 x 0.56 (14.3 x 14.3)	72	1000
PLL-23-Y3-5		Clear		72	5000
PLL-23-Y2-1	GMYP-W Polyester	White	0.56 x 0.56 (14.3 x 14.3)	72	1000
PLL-23-Y2-5		White		72	5000

Network Systems Labeling — Termination Position Labeling (cont.)



Faceplates Labels



- For use with **MINI-COM**® Executive and Designer Series Faceplates
- Adhesive label designed to fit on vinyl insert provided with faceplate
- Single and Double Gang versions available
- Can also be used to identify **MINI-COM** Surface Mount Boxes

Adhesive Faceplate Labels

Designed to work in Laser and Ink Jet Printers

Part Number	Faceplate Type	Material	Color	Label Width In. (mm)	Label Length In. (mm)	Horizontal Repeat In. (mm)	Vertical Repeat In. (mm)	No. of Col.	No. of Rows	Labels Per Sheet	Std. Pkg. Qty.*
JLEFPS-1	Single Gang	GMPO5-W Polyolefin	White	1.80 (45.7)	0.38 (9.5)	2.01(51.1)	0.45 (11.6)	4	21	84	1000
JLEFPD-1	Double Gang		White	0.30 (7.6)	2.90 (73.7)	0.38 (9.5)	3.30 (83.8)	21	3	63	1000

Non-Adhesive Faceplate Labels

Designed to work in Laser and Dot-Matrix Printers

Part Number	Faceplate Type	Material	Color	Label Width In. (mm)	Label Length In. (mm)	Horizontal Repeat In. (mm)	Vertical Repeat In. (mm)	No. of Col.	No. of Rows	Labels Per Sheet	Std. Pkg. Qty.*
EFPT-1	Single Gang	Semi-Rigid Paper	White	1.80 (45.7)	0.38 (9.5)	1.80 (45.7)	0.38 (9.5)	4	19	76	1000
EFPT10-1	Double Gang		White	2.90 (73.7)	0.30 (7.6)	2.90 (73.7)	0.30 (7.6)	2	24	48	1000

For more information on the complete line of **PAN-NET**™ Network Cabling System Products, ask for the Communication Products Catalog.

Self-Laminating Labels by Size



U.S. Letter Sheet Format
(8.5" x 11" / 215.9 mm x 279.4 mm)

Part Number	Material	Print-On Area Color	Label Width A In. (mm)	Label Length B In. (mm)	Print-On Area Length C In. (mm)	Horizontal Repeat D In. (mm)	Vertical Repeat E In. (mm)	No. of Col.	No. of Rows	Labels Per Sheet	Sheets Per Pkg.	Std. Pkg. Qty.*
PLL-3-Y3-5	Polyester	White	0.50 (12.7)	0.75 (19.1)	0.34 (8.64)	0.60 (15.2)	0.75 (19.1)	13	12	156	33	5000
PLL-33-Y3-5	Polyester	White	0.50 (12.7)	1.50 (38.1)	0.50 (12.7)	0.60 (15.2)	1.50 (38.1)	13	6	78	65	5000
PLL-10-Y3-2.5	Polyester	White	1.00 (25.4)	0.75 (19.1)	0.34 (8.64)	1.10 (27.9)	0.75 (19.1)	7	12	84	30	2500
PLL-10-Y3-5	Polyester	White	1.00 (25.4)	0.75 (19.1)	0.34 (8.64)	1.10 (27.9)	0.75 (19.1)	7	12	84	60	5000
PLL-11-Y3-2.5	Polyester	White	1.00 (25.4)	1.00 (25.4)	0.34 (8.64)	1.10 (27.9)	1.00 (25.4)	7	10	70	36	2500
PLL-11-Y3B-2.5	Polyester	TIA Blue	1.00 (25.4)	1.00 (25.4)	0.34 (8.64)	1.10 (27.9)	1.00 (25.4)	7	10	70	36	2500
PLL-11-Y3BR-2.5	Polyester	TIA Brown	1.00 (25.4)	1.00 (25.4)	0.34 (8.64)	1.10 (27.9)	1.00 (25.4)	7	10	70	36	2500
PLL-11-Y3G-2.5	Polyester	TIA Green	1.00 (25.4)	1.00 (25.4)	0.34 (8.64)	1.10 (27.9)	1.00 (25.4)	7	10	70	36	2500
PLL-11-Y3IG-2.5	Polyester	TIA Gray	1.00 (25.4)	1.00 (25.4)	0.34 (8.64)	1.10 (27.9)	1.00 (25.4)	7	10	70	36	2500
PLL-11-Y3OR-2.5	Polyester	TIA Orange	1.00 (25.4)	1.00 (25.4)	0.34 (8.64)	1.10 (27.9)	1.00 (25.4)	7	10	70	36	2500
PLL-11-Y3PR-2.5	Polyester	TIA Purple	1.00 (25.4)	1.00 (25.4)	0.34 (8.64)	1.10 (27.9)	1.00 (25.4)	7	10	70	36	2500
PLL-11-Y3RD-2.5	Polyester	TIA Red	1.00 (25.4)	1.00 (25.4)	0.34 (8.64)	1.10 (27.9)	1.00 (25.4)	7	10	70	36	2500
PLL-11-Y3Y-2.5	Polyester	TIA Yellow	1.00 (25.4)	1.00 (25.4)	0.34 (8.64)	1.10 (27.9)	1.00 (25.4)	7	10	70	36	2500
PLL-12-Y3-1	Polyester	White	1.00 (25.4)	1.33 (33.8)	0.47 (11.9)	1.10 (27.9)	1.33 (33.8)	7	7	49	21	1000
PLL-12-Y3-2.5	Polyester	White	1.00 (25.4)	1.33 (33.8)	0.47 (11.9)	1.10 (27.9)	1.33 (33.8)	7	7	49	52	2500
PLL-12-Y3B-2.5	Polyester	TIA Blue	1.00 (25.4)	1.33 (33.8)	0.47 (11.9)	1.10 (27.9)	1.33 (33.8)	7	7	49	52	2500
PLL-12-Y3BR-2.5	Polyester	TIA Brown	1.00 (25.4)	1.33 (33.8)	0.47 (11.9)	1.10 (27.9)	1.33 (33.8)	7	7	49	52	2500
PLL-12-Y3G-2.5	Polyester	TIA Green	1.00 (25.4)	1.33 (33.8)	0.47 (11.9)	1.10 (27.9)	1.33 (33.8)	7	7	49	52	2500
PLL-12-Y3IG-2.5	Polyester	TIA Gray	1.00 (25.4)	1.33 (33.8)	0.47 (11.9)	1.10 (27.9)	1.33 (33.8)	7	7	49	52	2500
PLL-12-Y3OR-2.5	Polyester	TIA Orange	1.00 (25.4)	1.33 (33.8)	0.47 (11.9)	1.10 (27.9)	1.33 (33.8)	7	7	49	52	2500
PLL-12-Y3PR-2.5	Polyester	TIA Purple	1.00 (25.4)	1.33 (33.8)	0.47 (11.9)	1.10 (27.9)	1.33 (33.8)	7	7	49	52	2500
PLL-12-Y3RD-2.5	Polyester	TIA Red	1.00 (25.4)	1.33 (33.8)	0.47 (11.9)	1.10 (27.9)	1.33 (33.8)	7	7	49	52	2500
PLL-12-Y3Y-2.5	Polyester	TIA Yellow	1.00 (25.4)	1.33 (33.8)	0.47 (11.9)	1.10 (27.9)	1.33 (33.8)	7	7	49	52	2500
PLL-39-Y3-1	Polyester	White	1.00 (25.4)	1.33 (33.8)	0.47 (11.9)	1.10 (27.9)	1.33 (33.8)	8	8	64	16	1000
PLL-13-Y3-D	Polyester	White	1.00 (25.4)	3.17 (80.5)	0.97 (24.6)	1.10 (27.9)	3.17 (80.5)	7	3	21	24	500
PLL-13-Y3-1	Polyester	White	1.00 (25.4)	3.17 (80.5)	0.97 (24.6)	1.10 (27.9)	3.17 (80.5)	7	3	21	48	1000
PLL-38-Y3-1	Polyester	White	1.00 (25.4)	5.45 (138.4)	1.00 (25.4)	1.10 (27.9)	5.45 (138.4)	7	2	14	72	1000
PLL-37-Y3-1	Polyester	White	1.88 (47.6)	3.17 (80.5)	0.97 (24.6)	2.00 (50.8)	3.17 (80.5)	4	3	12	84	1000
PLL-40-Y3-1	Polyester	White	2.00 (50.8)	1.50 (38.1)	0.50 (12.7)	2.00 (50.8)	1.50 (38.1)	4	6	24	42	1000
PLL-21-Y3-1	Polyester	White	2.00 (50.8)	3.17 (80.5)	1.00 (25.4)	2.50 (63.5)	3.17 (80.5)	3	3	9	111	1000

Self-Laminating Labels by Size (cont.)



DIN A4 Sheet Format
(8.26" x 11.69" / 210 mm x 297 mm)

Part Number	Material	Print-On Area Color	Label Width A In. (mm)	Label Length B In. (mm)	Print-On Area Length C In. (mm)	Horizontal Repeat D In. (mm)	Vertical Repeat E In. (mm)	No. of Col.	No. of Rows	Labels Per Sheet	Sheets Per Pkg.	Std. Pkg. Qty.*
PEL-17-Y3-2.5	Polyester	White	0.70 (17.8)	1.33 (33.8)	0.33 (8.5)	0.70 (17.8)	1.33 (33.8)	10	8	80	32	2500
PEL-17-BLU-2.5	Polyester	TIA Blue	0.70 (17.8)	1.33 (33.8)	0.33 (8.5)	0.70 (17.8)	1.33 (33.8)	10	8	80	32	2500
PEL-17-BRN-2.5	Polyester	TIA Brown	0.70 (17.8)	1.33 (33.8)	0.33 (8.5)	0.70 (17.8)	1.33 (33.8)	10	8	80	32	2500
PEL-17-GRN-2.5	Polyester	TIA Green	0.70 (17.8)	1.33 (33.8)	0.33 (8.5)	0.70 (17.8)	1.33 (33.8)	10	8	80	32	2500
PEL-17-GRY-2.5	Polyester	TIA Gray	0.70 (17.8)	1.33 (33.8)	0.33 (8.5)	0.70 (17.8)	1.33 (33.8)	10	8	80	32	2500
PEL-17-ORN-2.5	Polyester	TIA Orange	0.70 (17.8)	1.33 (33.8)	0.33 (8.5)	0.70 (17.8)	1.33 (33.8)	10	8	80	32	2500
PEL-17-PUR-2.5	Polyester	TIA Purple	0.70 (17.8)	1.33 (33.8)	0.33 (8.5)	0.70 (17.8)	1.33 (33.8)	10	8	80	32	2500
PEL-17-RED-2.5	Polyester	TIA Red	0.70 (17.8)	1.33 (33.8)	0.33 (8.5)	0.70 (17.8)	1.33 (33.8)	10	8	80	32	2500
PEL-17-YEL-2.5	Polyester	TIA Yellow	0.70 (17.8)	1.33 (33.8)	0.33 (8.5)	0.70 (17.8)	1.33 (33.8)	10	8	80	32	2500
PEL-18-PO3-1	Polyolefin	White	0.90 (22.9)	2.17 (55.0)	0.50 (12.7)	0.90 (22.9)	2.17 (55.0)	8	5	40	25	1000
PEL-18-Y3-1	Polyester	White	0.90 (22.9)	2.17 (55.0)	0.50 (12.7)	0.90 (22.9)	2.17 (55.0)	8	5	40	25	1000
PEL-18-BLU-1	Polyester	TIA Blue	0.90 (22.9)	2.17 (55.0)	0.50 (12.7)	0.90 (22.9)	2.17 (55.0)	8	5	40	25	1000
PEL-18-BRN-1	Polyester	TIA Brown	0.90 (22.9)	2.17 (55.0)	0.50 (12.7)	0.90 (22.9)	2.17 (55.0)	8	5	40	25	1000
PEL-18-GRN-1	Polyester	TIA Green	0.90 (22.9)	2.17 (55.0)	0.50 (12.7)	0.90 (22.9)	2.17 (55.0)	8	5	40	25	1000
PEL-18-GRY-1	Polyester	TIA Gray	0.90 (22.9)	2.17 (55.0)	0.50 (12.7)	0.90 (22.9)	2.17 (55.0)	8	5	40	25	1000
PEL-18-ORN-1	Polyester	TIA Orange	0.90 (22.9)	2.17 (55.0)	0.50 (12.7)	0.90 (22.9)	2.17 (55.0)	8	5	40	25	1000
PEL-18-PUR-1	Polyester	TIA Purple	0.90 (22.9)	2.17 (55.0)	0.50 (12.7)	0.90 (22.9)	2.17 (55.0)	8	5	40	25	1000
PEL-18-RED-1	Polyester	TIA Red	0.90 (22.9)	2.17 (55.0)	0.50 (12.7)	0.90 (22.9)	2.17 (55.0)	8	5	40	25	1000
PEL-18-YEL-1	Polyester	TIA Yellow	0.90 (22.9)	2.17 (55.0)	0.50 (12.7)	0.90 (22.9)	2.17 (55.0)	8	5	40	25	1000
PEL-19-Y3-1	Polyester	White	1.00 (25.4)	2.67 (67.7)	0.67 (16.9)	1.00 (25.4)	2.67 (67.7)	7	4	28	36	1000
PEL-19-BLU-1	Polyester	TIA Blue	1.00 (25.4)	2.67 (67.7)	0.67 (16.9)	1.00 (25.4)	2.67 (67.7)	7	4	28	36	1000
PEL-19-BRN-1	Polyester	TIA Brown	1.00 (25.4)	2.67 (67.7)	0.67 (16.9)	1.00 (25.4)	2.67 (67.7)	7	4	28	36	1000
PEL-19-GRN-1	Polyester	TIA Green	1.00 (25.4)	2.67 (67.7)	0.67 (16.9)	1.00 (25.4)	2.67 (67.7)	7	4	28	36	1000
PEL-19-GRY-1	Polyester	TIA Gray	1.00 (25.4)	2.67 (67.7)	0.67 (16.9)	1.00 (25.4)	2.67 (67.7)	7	4	28	36	1000
PEL-19-ORN-1	Polyester	TIA Orange	1.00 (25.4)	2.67 (67.7)	0.67 (16.9)	1.00 (25.4)	2.67 (67.7)	7	4	28	36	1000
PEL-19-PUR-1	Polyester	TIA Purple	1.00 (25.4)	2.67 (67.7)	0.67 (16.9)	1.00 (25.4)	2.67 (67.7)	7	4	28	36	1000
PEL-19-RED-1	Polyester	TIA Red	1.00 (25.4)	2.67 (67.7)	0.67 (16.9)	1.00 (25.4)	2.67 (67.7)	7	4	28	36	1000
PEL-19-YEL-1	Polyester	TIA Yellow	1.00 (25.4)	2.67 (67.7)	0.67 (16.9)	1.00 (25.4)	2.67 (67.7)	7	4	28	36	1000
PEL-20-Y3-1	Polyester	White	1.20 (30.5)	2.67 (67.7)	0.83 (21.1)	1.20 (30.5)	2.67 (67.7)	6	4	24	42	1000
PEL-21-Y3-0.5	Polyester	White	1.40 (35.6)	3.67 (93.1)	1.00 (25.4)	1.40 (35.6)	3.67 (93.1)	5	3	15	34	500
PEL-21-BLU-0.5	Polyester	TIA Blue	1.40 (35.6)	3.67 (93.1)	1.00 (25.4)	1.40 (35.6)	3.67 (93.1)	5	3	15	34	500
PEL-21-BRN-0.5	Polyester	TIA Brown	1.40 (35.6)	3.67 (93.1)	1.00 (25.4)	1.40 (35.6)	3.67 (93.1)	5	3	15	34	500
PEL-21-GRN-0.5	Polyester	TIA Green	1.40 (35.6)	3.67 (93.1)	1.00 (25.4)	1.40 (35.6)	3.67 (93.1)	5	3	15	34	500
PEL-21-GRY-0.5	Polyester	TIA Gray	1.40 (35.6)	3.67 (93.1)	1.00 (25.4)	1.40 (35.6)	3.67 (93.1)	5	3	15	34	500
PEL-21-ORN-0.5	Polyester	TIA Orange	1.40 (35.6)	3.67 (93.1)	1.00 (25.4)	1.40 (35.6)	3.67 (93.1)	5	3	15	34	500
PEL-21-PUR-0.5	Polyester	TIA Purple	1.40 (35.6)	3.67 (93.1)	1.00 (25.4)	1.40 (35.6)	3.67 (93.1)	5	3	15	34	500
PEL-21-RED-0.5	Polyester	TIA Red	1.40 (35.6)	3.67 (93.1)	1.00 (25.4)	1.40 (35.6)	3.67 (93.1)	5	3	15	34	500
PEL-21-YEL-0.5	Polyester	TIA Yellow	1.40 (35.6)	3.67 (93.1)	1.00 (25.4)	1.40 (35.6)	3.67 (93.1)	5	3	15	34	500
PEL-22-Y3-0.5	Polyester	White	1.40 (35.6)	5.50 (140.0)	1.00 (25.4)	1.40 (35.6)	5.50 (140.0)	5	2	10	50	500
PEL-23-Y3-0.5	Polyester	White	1.80 (45.7)	5.50 (140.0)	1.167 (29.6)	1.80 (45.7)	5.50 (140.0)	4	2	8	63	500

*Order number of labels required in multiples of Std. Pkg. Qty.

Blank Labels by Size



**U.S. Letter Sheet Format
(8.5" x 11" / 215.9 mm x 279.4 mm)**

Part Number	Material	Color	Label Width A In. (mm)	Label Length B In. (mm)	Horizontal Repeat D In. (mm)	Vertical Repeat E In. (mm)	No. of Col.	No. of Rows	Labels Per Sheet	Sheets Per Pkg	Std. Pkg. Qty*
PLL-2-Y2-10	Polyester	White	0.38 (9.5)	0.38 (9.5)	0.50 (12.7)	0.38 (9.5)	16	25	400	25	10,000
PLL-2-Y2Y-10	Polyester	Yellow	0.38 (9.5)	0.38 (9.5)	0.50 (12.7)	0.38 (9.5)	16	25	400	25	10,000
PLL-31-Y2-10	Polyester	White	0.50 (12.7)	0.44 (11.1)	0.60 (15.2)	0.44 (11.1)	13	22	286	35	10,000
PLL-31-POR-10	Remov. Polyolefin	White	0.50 (12.7)	0.44 (11.1)	0.60 (15.2)	0.44 (11.1)	13	22	286	35	10,000
PLL-33-PO-5	Polyolefin	White	0.50 (12.7)	1.50 (38.1)	0.60 (15.2)	1.50 (38.1)	13	6	78	65	5000
PLL-24-Y2-1	Polyester	White	0.56 (14.3)	0.19 (4.8)	0.80 (20.3)	0.40 (10.2)	10	24	240	5	1000
PLL-24-Y2-5	Polyester	White	0.56 (14.3)	0.19 (4.8)	0.80 (20.3)	0.40 (10.2)	10	24	240	21	5000
PLL-24-Y3-1	Polyester	Clear	0.56 (14.3)	0.19 (4.8)	0.80 (20.3)	0.40 (10.2)	10	24	240	5	1000
PLL-24-Y3-5	Polyester	Clear	0.56 (14.3)	0.19 (4.8)	0.80 (20.3)	0.40 (10.2)	10	24	240	21	5000
PLL-23-Y2-1	Polyester	White	0.56 (14.3)	0.56 (14.3)	0.80 (20.3)	0.80 (20.3)	10	12	120	9	1000
PLL-23-Y2-5	Polyester	White	0.56 (14.3)	0.56 (14.3)	0.80 (20.3)	0.80 (20.3)	10	12	120	42	5000
PLL-23-Y3-1	Polyester	Clear	0.56 (14.3)	0.56 (14.3)	0.80 (20.3)	0.80 (20.3)	10	12	120	9	1000
PLL-23-Y3-5	Polyester	Clear	0.56 (14.3)	0.56 (14.3)	0.80 (20.3)	0.80 (20.3)	10	12	120	42	5000
PLL-32-Y2-10	Polyester	White	0.65 (16.5)	0.20 (5.1)	0.80 (20.3)	0.20 (5.1)	10	48	480	21	10,000
PLL-32-Y2Y-10	Polyester	Yellow	0.65 (16.5)	0.20 (5.1)	0.80 (20.3)	0.20 (5.1)	10	48	480	21	10,000
PLL-4-Y2-10	Polyester	White	0.65 (16.5)	0.25 (6.4)	0.80 (20.3)	0.25 (6.4)	10	39	390	26	10,000
PLL-4-Y2Y-10	Polyester	Yellow	0.65 (16.5)	0.25 (6.4)	0.80 (20.3)	0.25 (6.4)	10	39	390	26	10,000
PLL-20-Y2-10	Polyester	White	0.80 (20.3)	0.20 (5.1)	1.00 (25.4)	0.20 (5.1)	8	45	360	28	10,000
PLL-20-Y2Y-10	Polyester	Yellow	0.80 (20.3)	0.20 (5.1)	1.00 (25.4)	0.20 (5.1)	8	45	360	28	10,000
PLL-5-Y2-10	Polyester	White	0.80 (20.3)	0.25 (6.4)	1.00 (25.4)	0.25 (6.4)	8	39	312	33	10,000
PLL-5-Y2Y-10	Polyester	Yellow	0.80 (20.3)	0.25 (6.4)	1.00 (25.4)	0.25 (6.4)	8	39	312	33	10,000
PLL-6-Y2-5	Polyester	White	0.80 (20.3)	0.50 (12.7)	1.00 (25.4)	0.50 (12.7)	8	19	152	33	5000
PLL-6-Y2-10	Polyester	White	0.80 (20.3)	0.50 (12.7)	1.00 (25.4)	0.50 (12.7)	8	19	152	66	10,000
PLL-6-Y2Y-5	Polyester	Yellow	0.80 (20.3)	0.50 (12.7)	1.00 (25.4)	0.50 (12.7)	8	19	152	66	5000
PLL-6-Y2Y-10	Polyester	Yellow	0.80 (20.3)	0.50 (12.7)	1.00 (25.4)	0.50 (12.7)	8	19	152	33	10,000
PLL-7-Y2-10	Polyester	White	1.00 (25.4)	0.25 (6.4)	1.10 (27.9)	0.25 (6.4)	7	39	273	37	10,000
PLL-7-Y2Y-10	Polyester	Yellow	1.00 (25.4)	0.25 (6.4)	1.10 (27.9)	0.25 (6.4)	7	39	273	37	10,000
PLL-8-Y2-5	Polyester	White	1.00 (25.4)	0.38 (9.5)	1.10 (27.9)	0.38 (9.5)	7	25	175	58	5000
PLL-8-Y2-10	Polyester	White	1.00 (25.4)	0.38 (9.5)	1.10 (27.9)	0.38 (9.5)	7	25	175	29	10,000
PLL-8-Y2Y-5	Polyester	Yellow	1.00 (25.4)	0.38 (9.5)	1.10 (27.9)	0.38 (9.5)	7	25	175	58	5000
PLL-8-Y2Y-10	Polyester	Yellow	1.00 (25.4)	0.38 (9.5)	1.10 (27.9)	0.38 (9.5)	7	25	175	29	10,000
PLL-8-PO-10	Polyolefin	White	1.00 (25.4)	0.38 (9.5)	1.10 (27.9)	0.38 (9.5)	7	25	175	58	10,000

Blank Labels by Size (cont.)



**U.S. Letter Sheet Format
(8.5" x 11" / 215.9 mm x 279.4 mm)**

Part Number	Material	Color	Label Width A In. (mm)	Label Length B In. (mm)	Horizontal Repeat D In. (mm)	Vertical Repeat E In. (mm)	No. of Col.	No. of Rows	Labels Per Sheet	Sheets Per Pkg	Std. Pkg. Qty*
PLL-9-Y2-5	Polyester	White	1.00 (25.4)	0.50 (12.7)	1.10 (27.9)	0.50 (12.7)	7	19	133	76	5000
PLL-9-Y2-10	Polyester	White	1.00 (25.4)	0.50 (12.7)	1.10 (27.9)	0.50 (12.7)	7	19	133	38	10,000
PLL-9-Y2S-10	Polyester	Silver	1.00 (25.4)	0.50 (12.7)	1.10 (27.9)	0.50 (12.7)	7	19	133	76	10,000
PLL-9-Y2Y-5	Polyester	Yellow	1.00 (25.4)	0.50 (12.7)	1.10 (27.9)	0.50 (12.7)	7	19	133	76	5000
PLL-9-Y2Y-10	Polyester	Yellow	1.00 (25.4)	0.50 (12.7)	1.10 (27.9)	0.50 (12.7)	7	19	133	38	10,000
PLL-9-Y3C-5	Polyester	Clear	1.00 (25.4)	0.50 (12.7)	1.10 (27.9)	0.50 (12.7)	7	19	133	38	5000
PLL-9-POR-10	Remov. Polyolefin	White	1.00 (25.4)	0.50 (12.7)	1.10 (27.9)	0.50 (12.7)	7	19	133	76	10,000
PLL-10-Y2-2.5	Polyester	White	1.00 (25.4)	0.75 (19.1)	1.10 (27.9)	0.75 (19.1)	7	12	84	30	2500
PLL-10-Y3C-2.5	Polyester	Clear	1.00 (25.4)	0.75 (19.1)	1.10 (27.9)	0.75 (19.1)	7	12	84	30	2500
PLL-10-PO-5	Polyolefin	White	1.00 (25.4)	0.75 (19.1)	1.10 (27.9)	0.75 (19.1)	7	12	84	30	5000
PLL-11-Y2-2.5	Polyester	White	1.00 (25.4)	1.00 (25.4)	1.10 (27.9)	1.00 (25.4)	7	10	70	36	2500
PLL-11-Y3C-2.5	Polyester	Clear	1.00 (25.4)	1.00 (25.4)	1.10 (27.9)	1.00 (25.4)	7	10	70	36	2500
PLL-12-Y2-1	Polyester	White	1.00 (25.4)	1.33 (33.8)	1.10 (27.9)	1.33 (33.8)	7	7	49	21	1000
PLL-12-Y2-2.5	Polyester	White	1.00 (25.4)	1.33 (33.8)	1.10 (27.9)	1.33 (33.8)	7	7	49	52	2500
PLL-34-Y2-10	Polyester	White	1.25 (31.8)	0.38 (9.5)	1.10 (27.9)	0.38 (9.5)	5	25	125	80	10,000
PLL-34-Y2Y-10	Polyester	Yellow	1.25 (31.8)	0.38 (9.5)	1.60 (40.6)	0.38 (9.5)	5	25	125	80	10,000
PLL-34-POR-10	Remov. Polyolefin	White	1.25 (31.8)	0.38 (9.5)	1.60 (40.6)	0.38 (9.5)	5	25	125	80	10,000
PLL-14-Y2-5	Polyester	White	1.50 (38.1)	0.25 (6.4)	1.60 (40.6)	0.25 (6.4)	5	39	195	52	5000
PLL-14-Y2-10	Polyester	White	1.50 (38.1)	0.25 (6.4)	1.60 (40.6)	0.25 (6.4)	5	39	195	26	10,000
PLL-14-Y2Y-5	Polyester	Yellow	1.50 (38.1)	0.25 (6.4)	1.60 (40.6)	0.25 (6.4)	5	39	195	26	5000
PLL-14-PO-5	Polyolefin	White	1.50 (38.1)	0.25 (6.4)	1.60 (40.6)	0.25 (6.4)	5	39	195	26	5000
PLL-14-POR-5	Remov. Polyolefin	White	1.50 (38.1)	0.25 (6.4)	1.60 (40.6)	0.25 (6.4)	5	39	195	26	5000
PLL-35-Y2S-2.5	Polyester	Silver	1.50 (38.1)	0.75 (19.1)	1.60 (40.6)	0.75 (19.1)	5	12	60	42	2500
PLL-35-PO-2.5	Polyolefin	White	1.50 (38.1)	0.75 (19.1)	1.60 (40.6)	0.75 (19.1)	5	12	60	42	2500
PLL-35-POR-2.5	Remov. Polyolefin	White	1.50 (38.1)	0.75 (19.1)	1.60 (40.6)	0.75 (19.1)	5	12	60	42	2500
PLL-15-Y2-5	Polyester	White	1.88 (47.6)	0.25 (6.4)	2.00 (50.8)	0.25 (6.4)	4	39	156	65	5000
PLL-15-Y2-10	Polyester	White	1.88 (47.6)	0.25 (6.4)	2.00 (50.8)	0.25 (6.4)	4	39	156	33	10,000
PLL-15-Y2Y-5	Polyester	Yellow	1.88 (47.6)	0.25 (6.4)	2.00 (50.8)	0.25 (6.4)	4	39	156	33	5000
PLL-16-Y2-2.5	Polyester	White	1.88 (47.6)	0.38 (9.5)	2.00 (50.8)	0.38 (9.5)	4	25	100	25	2500
PLL-16-Y2-5	Polyester	White	1.88 (47.6)	0.38 (9.5)	2.00 (50.8)	0.38 (9.5)	4	25	100	50	5000
PLL-16-Y2Y-2.5	Polyester	Yellow	1.88 (47.6)	0.38 (9.5)	2.00 (50.8)	0.38 (9.5)	4	25	100	25	2500
PLL-16-Y2Y-5	Polyester	Yellow	1.88 (47.6)	0.38 (9.5)	2.00 (50.8)	0.38 (9.5)	4	25	100	50	5000
PLL-16-PO-2.5	Polyolefin	White	1.88 (47.6)	0.38 (9.5)	2.00 (50.8)	0.38 (9.5)	4	25	100	25	2500
PLL-17-Y2-1	Polyester	White	1.88 (47.6)	0.83 (21.1)	2.00 (50.8)	0.83 (21.1)	4	11	44	23	1000
PLL-17-Y2-2.5	Polyester	White	1.88 (47.6)	0.83 (21.1)	2.00 (50.8)	0.83 (21.1)	4	11	44	57	2500
PLL-17-Y2Y-2.5	Polyester	Yellow	1.88 (47.6)	0.83 (21.1)	2.00 (50.8)	0.83 (21.1)	4	11	44	57	2500
PLL-17-PO-2.5	Polyolefin	White	1.88 (47.6)	0.83 (21.1)	2.00 (50.8)	0.83 (21.1)	4	11	44	57	2500

*Order number of labels required in multiples of Std. Pkg. Qty.

Blank Labels by Size (cont.)



**U.S. Letter Sheet Format
(8.5" x 11" / 215.9 mm x 279.4 mm)**

Part Number	Material	Color	Label Width A In. (mm)	Label Length B In. (mm)	Horizontal Repeat D In. (mm)	Vertical Repeat E In. (mm)	No. of Col.	No. of Rows	Labels Per Sheet	Sheets Per Pkg	Std. Pkg. Qty*
PLL-18-Y2-1	Polyester	White	1.88 (47.6)	1.33 (33.8)	2.00 (50.8)	1.33 (33.8)	4	7	28	36	1000
PLL-18-Y2-1.5	Polyester	White	1.88 (47.6)	1.33 (33.8)	2.00 (50.8)	1.33 (33.8)	4	7	28	54	1500
PLL-18-Y2Y-1	Polyester	Yellow	1.88 (47.6)	1.33 (33.8)	2.00 (50.8)	1.33 (33.8)	4	7	28	36	1000
PLL-18-Y2Y-1.5	Polyester	Yellow	1.88 (47.6)	1.33 (33.8)	2.00 (50.8)	1.33 (33.8)	4	7	28	54	1500
PLL-36-Y2-1	Polyester	White	2.50 (63.5)	1.00 (25.4)	2.60 (66.0)	1.00 (25.4)	3	9	27	38	1000
PLL-36-Y2S-1	Polyester	Silver	2.50 (63.5)	1.00 (25.4)	2.60 (66.0)	1.00 (25.4)	3	9	27	38	1000
PLL-36-PO-1	Polyolefin	White	2.50 (63.5)	1.00 (25.4)	2.60 (66.0)	1.00 (25.4)	3	9	27	38	1000
PLL-36-POR-1	Remov. Polyolefin	White	2.50 (63.5)	1.00 (25.4)	2.60 (66.0)	1.00 (25.4)	3	9	27	38	1000
PLL-26-Y2-1	Polyester	White	2.83 (72.0)	1.00 (25.4)	2.83 (72.0)	1.00 (25.4)	3	11	33	31	1000
PLL-27-Y2-1	Polyester	White	2.83 (72.0)	1.38 (34.9)	2.83 (72.0)	1.38 (34.9)	3	8	24	42	1000
PLL-28-Y2-1	Polyester	White	2.83 (72.0)	1.50 (38.1)	2.83 (72.0)	1.50 (38.1)	3	7	21	48	1000
PLL-19-Y2-1	Polyester	White	3.00 (76.2)	0.38 (9.5)	3.20 (81.3)	0.38 (9.5)	2	25	50	20	1000
PLL-19-Y2-2.5	Polyester	White	3.00 (76.2)	0.38 (9.5)	3.20 (81.3)	0.38 (9.5)	2	25	50	50	2500
PLL-19-Y2Y-1	Polyester	Yellow	3.00 (76.2)	0.38 (9.5)	3.20 (81.3)	0.38 (9.5)	2	25	50	20	1000
PLL-19-Y2Y-2.5	Polyester	Yellow	3.00 (76.2)	0.38 (9.5)	3.20 (81.3)	0.38 (9.5)	2	25	50	50	2500
PLL-19-POR-2.5	Remov. Polyolefin	White	3.00 (76.2)	0.38 (9.5)	3.20 (81.3)	0.38 (9.5)	2	25	50	50	2500
PLL-29-Y2-1	Polyester	White	4.25 (108.0)	2.00 (50.8)	4.25 (108.0)	2.00 (50.8)	2	5	10	100	1000
PLL-22-Y2-1	Polyester	White	7.88 (200.0)	0.50 (12.7)	—	0.50 (12.7)	1	20	20	50	1000
PLL-22-Y3-1	Polyester	Clear	7.88 (200.0)	0.50 (12.7)	—	0.50 (12.7)	1	20	20	50	1000
PLL-22-PO-1	Polyolefin	White	7.88 (200.0)	0.50 (12.7)	—	0.50 (12.7)	1	20	20	50	1000
PLL-22-PO-1B	Polyolefin	Blue	7.88 (200.0)	0.50 (12.7)	—	0.50 (12.7)	1	20	20	50	1000
PLL-22-PO-1BR	Polyolefin	Brown	7.88 (200.0)	0.50 (12.7)	—	0.50 (12.7)	1	20	20	50	1000
PLL-22-PO-1G	Polyolefin	Green	7.88 (200.0)	0.50 (12.7)	—	0.50 (12.7)	1	20	20	50	1000
PLL-22-PO-1GR	Polyolefin	Gray	7.88 (200.0)	0.50 (12.7)	—	0.50 (12.7)	1	20	20	50	1000
PLL-22-PO-1OR	Polyolefin	Orange	7.88 (200.0)	0.50 (12.7)	—	0.50 (12.7)	1	20	20	50	1000
PLL-22-PO-1PR	Polyolefin	Purple	7.88 (200.0)	0.50 (12.7)	—	0.50 (12.7)	1	20	20	50	1000
PLL-22-PO-1R	Polyolefin	Red	7.88 (200.0)	0.50 (12.7)	—	0.50 (12.7)	1	20	20	50	1000
PLL-22-PO-1Y	Polyolefin	Yellow	7.88 (200.0)	0.50 (12.7)	—	0.50 (12.7)	1	20	20	50	1000
PLL-25-Y2-SH	Polyester	White	8.50 (215.9)	11.00 (279.4)	—	—	1	1	1	25	25
PLL-25-Y2S-SH	Polyester	Silver	8.50 (215.9)	11.00 (279.4)	—	—	1	1	1	25	25
PLL-25-Y2Y-SH	Polyester	Yellow	8.50 (215.9)	11.00 (279.4)	—	—	1	1	1	25	25
PLL-25-Y3C-SH	Polyester	Clear	8.50 (215.9)	11.00 (279.4)	—	—	1	1	1	25	25
PLL-25-PO-SH	Polyolefin	White	8.50 (215.9)	11.00 (279.4)	—	—	1	1	1	25	25
PLL-25-POR-SH	Remov. Polyolefin	White	8.50 (215.9)	11.00 (279.4)	—	—	1	1	1	25	25

Blank Labels by Size (cont.)

Multiple Across – Double Butt-Cut



Part Number	Material	Color	Label Width A In. (mm)	Label Length B In. (mm)	Horizontal Repeat D In. (mm)	Vertical Repeat E In. (mm)	No. of Col.	No. of Rows	Labels Per Sheet	Sheets Per Pkg	Std. Pkg. Qty*
PLL-30-Y2-10	Polyester	White	0.25 (6.4)	0.25 (6.4)	0.60 (15.2)	0.25 (6.4)	26	36	936	11	10,000
PLL-1-Y2-10	Polyester	White	0.30 (7.6)	0.25 (6.4)	0.70 (17.8)	0.25 (6.4)	22	38	836	12	10,000
PLL-1-Y2Y-10	Polyester	Yellow	0.30 (7.6)	0.25 (6.4)	0.70 (17.8)	0.25 (6.4)	22	38	836	12	10,000

*Order number of labels required in multiples of Std. Pkg. Qty.

Blank Paper Labels (LL) - Drawings and Specifications

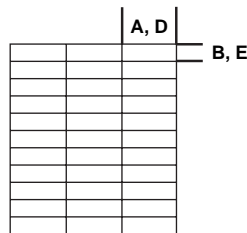

LL2561-100, 250, 500

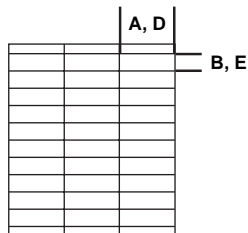

LL2561-100G

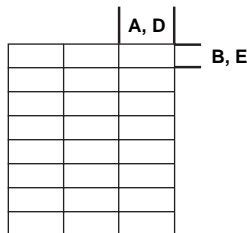

LL2561138-100

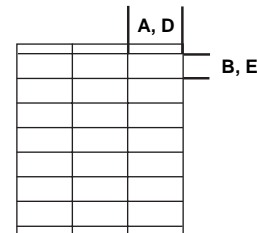

LL25615-100G

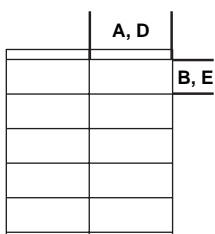

LL4252-100G

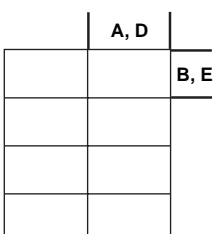

LL42575-250

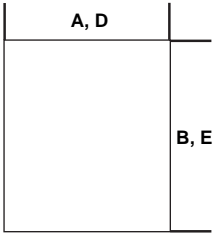

LL8511-100

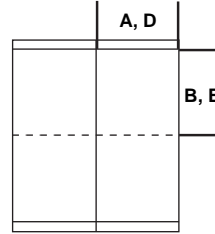

LL42513-100G

Part Number	Material	Color	Label Width A In. (mm)	Label Length B In. (mm)	Horizontal Repeat D In. (mm)	Vertical Repeat E In. (mm)	No. of Col.	No. of Rows	Labels Per Sheet	Sheets Per Pkg	Labels Per Pkg.	Std. Pkg. Qty*
LL2561-100G	Litho Paper	White	2.83 (72.0)	1.00 (25.4)	2.83 (72.0)	1.00 (25.4)	3	10	30	100	3000	1 Pkg.
LL2561-100	Litho Paper	White	2.83 (72.0)	1.00 (25.4)	2.83 (72.0)	1.00 (25.4)	3	11	33	100	3300	1 Pkg.
LL2561-250	Litho Paper	White	2.83 (72.0)	1.00 (25.4)	2.83 (72.0)	1.00 (25.4)	3	11	33	250	8250	1 Pkg.
LL2561-500	Litho Paper	White	2.83 (72.0)	1.00 (25.4)	2.83 (72.0)	1.00 (25.4)	3	11	33	500	16,500	1 Pkg.
LL256138-100	Litho Paper	White	2.83 (72.0)	1.38 (34.9)	2.83 (72.0)	1.38 (34.9)	3	8	24	100	2400	1 Pkg.
LL25615-100G	Litho Paper	White	2.83 (72.0)	1.50 (38.1)	2.83 (72.0)	1.50 (38.1)	3	7	21	100	2100	1 Pkg.
LL4252-100G	Litho Paper	White	4.25 (108.0)	2.00 (50.8)	4.25 (108.0)	2.00 (50.8)	2	5	10	100	1000	1 Pkg.
LL42575-250	Litho Paper	White	4.25 (108.0)	2.75 (69.9)	4.25 (108.0)	2.75 (69.9)	2	4	8	250	2000	1 Pkg.
LL42513-100G	Litho Paper	White	4.25 (108.0)	13.00 (330.2)	4.25 (108.0)	13.00 (330.2)	2	2	4	100	400	1 Pkg.
LL8511-100	Litho Paper	White	8.50 (215.9)	11.00 (279.4)	8.50 (215.9)	11.00 (279.4)	1	1	1	100	100	1 Pkg.

*"G" in above part numbers indicates gripper areas (top and bottom margins per sheet), not available for printing.

*Order number of packages required in multiples of Std. Pkg. Qty.

Blank Labels by Size (cont.)



**DIN A4 Sheet Format
(8.26" x 11.69" / 210 mm x 297 mm)**

Part Number	Material	Color	Label Width A In. (mm)	Label Length B In. (mm)	Horizontal Repeat D In. (mm)	Vertical Repeat E In. (mm)	No. of Col.	No. of Rows	Labels Per Sheet	Sheets Per Pkg	Std. Pkg. Qty*
PEL-25-Y2Y-10	Polyester	Yellow	0.35 (9.0)	0.59 (15.0)	0.35 (9.0)	0.59 (15.0)	12	31	372	27	10,000
PEL-26-Y2Y-5	Polyester	Yellow	0.43 (11.0)	0.75 (19.1)	0.43 (11.0)	0.75 (19.1)	10	25	250	20	5000
PEL-27-Y2Y-5	Polyester	Yellow	0.43 (11.0)	1.50 (38.1)	0.43 (11.0)	1.50 (38.1)	5	25	125	40	5000
PEL-9-Y1-10	Polyester	Silver	0.50 (12.7)	0.50 (12.7)	0.50 (12.7)	0.50 (12.7)	14	22	308	33	10,000
PEL-9-Y2-10	Polyester	White	0.50 (12.7)	0.50 (12.7)	0.50 (12.7)	0.50 (12.7)	14	22	308	33	10,000
PEL-9-Y1C-10	Tamper Evident Polyester	Silver	0.50 (12.7)	0.50 (12.7)	0.50 (12.7)	0.50 (12.7)	14	22	308	33	10,000
PEL-29-Y2-10	Polyester	White	0.56 (14.3)	0.25 (6.4)	0.56 (14.3)	0.25 (6.4)	13	43	559	18	10,000
PEL-29-Y3M-10	Polyester	Matte Clear	0.56 (14.3)	0.25 (6.4)	0.56 (14.3)	0.25 (6.4)	13	43	559	18	10,000
PEL-28-Y2-5	Polyester	White	0.56 (14.3)	0.56 (14.3)	0.56 (14.3)	0.56 (14.3)	13	19	247	41	5000
PEL-28-Y3M-5	Polyester	Matte Clear	0.56 (14.3)	0.56 (14.3)	0.56 (14.3)	0.56 (14.3)	13	19	247	41	5000
PEL-1-Y1-10	Polyester	Silver	0.70 (17.8)	0.25 (6.4)	0.70 (17.8)	0.25 (6.4)	10	45	450	23	10,000
PEL-1-Y2-10	Polyester	White	0.70 (17.8)	0.25 (6.4)	0.70 (17.8)	0.25 (6.4)	10	45	450	23	10,000
PEL-4-Y1-10	Polyester	Silver	0.70 (17.8)	0.33 (8.5)	0.70 (17.8)	0.33 (8.5)	10	33	330	31	10,000
PEL-4-Y2-10	Polyester	White	0.70 (17.8)	0.33 (8.5)	0.70 (17.8)	0.33 (8.5)	10	33	330	31	10,000
PEL-4-Y2Y-10	Polyester	Yellow	0.70 (17.8)	0.33 (8.5)	0.70 (17.8)	0.33 (8.5)	10	33	330	31	10,000
PEL-4-Y1C-10	Tamper Evident Polyester	Silver	0.70 (17.8)	0.33 (8.5)	0.70 (17.8)	0.33 (8.5)	10	33	330	31	10,000
PEL-10-Y1-5	Polyester	Silver	0.70 (17.8)	0.50 (12.7)	0.70 (17.8)	0.50 (12.7)	10	22	220	23	5000
PEL-10-Y2-5	Polyester	White	0.70 (17.8)	0.50 (12.7)	0.70 (17.8)	0.50 (12.7)	10	22	220	23	5000
PEL-10-Y2Y-5	Polyester	Yellow	0.70 (17.8)	0.50 (12.7)	0.70 (17.8)	0.50 (12.7)	10	22	220	23	5000
PEL-10-Y3M-5	Polyester	Matte Clear	0.70 (17.8)	0.50 (12.7)	0.70 (17.8)	0.50 (12.7)	10	22	220	23	5000
PEL-24-Y2Y-10	Polyester	Yellow	0.79 (20.0)	0.31 (8.0)	0.79 (20.2)	0.31 (8.0)	9	35	315	32	10,000
PEL-5-Y1-10	Polyester	Silver	0.80 (20.3)	0.33 (8.5)	0.80 (20.3)	0.33 (8.5)	9	33	297	34	10,000
PEL-5-Y2-10	Polyester	White	0.80 (20.3)	0.33 (8.5)	0.80 (20.3)	0.33 (8.5)	9	33	297	34	10,000
PEL-5-Y2Y-10	Polyester	Yellow	0.80 (20.3)	0.33 (8.5)	0.80 (20.3)	0.33 (8.5)	9	33	297	34	10,000
PEL-2-Y1-10	Polyester	Silver	1.00 (25.4)	0.25 (6.4)	1.00 (25.4)	0.25 (6.4)	7	45	315	32	10,000
PEL-2-Y2-10	Polyester	White	1.00 (25.4)	0.25 (6.4)	1.00 (25.4)	0.25 (6.4)	7	45	315	32	10,000
PEL-2-Y2Y-10	Polyester	Yellow	1.00 (25.4)	0.25 (6.4)	1.00 (25.4)	0.25 (6.4)	7	45	315	32	10,000
PEL-2-Y3M-10	Polyester	Matte Clear	1.00 (25.4)	0.25 (6.4)	1.00 (25.4)	0.25 (6.4)	7	45	315	32	10,000
PEL-6-Y1-5	Polyester	Silver	1.00 (25.4)	0.33 (8.5)	1.00 (25.4)	0.33 (8.5)	7	33	231	22	5000
PEL-6-Y2-5	Polyester	White	1.00 (25.4)	0.33 (8.5)	1.00 (25.4)	0.33 (8.5)	7	33	231	22	5000
PEL-6-Y1C-5	Tamper Evident Polyester	Silver	1.00 (25.4)	0.33 (8.5)	1.00 (25.4)	0.33 (8.5)	7	33	231	22	5000
PEL-11-Y1-5	Polyester	Silver	1.00 (25.4)	0.50 (12.7)	1.00 (25.4)	0.50 (12.7)	7	22	154	33	5000
PEL-11-Y2-5	Polyester	White	1.00 (25.4)	0.50 (12.7)	1.00 (25.4)	0.50 (12.7)	7	22	154	33	5000
PEL-11-Y2Y-5	Polyester	Yellow	1.00 (25.4)	0.50 (12.7)	1.00 (25.4)	0.50 (12.7)	7	22	154	33	5000
PEL-11-Y1C-5	Tamper Evident Polyester	Silver	1.00 (25.4)	0.50 (12.7)	1.00 (25.4)	0.50 (12.7)	7	22	154	33	5000

Laser Labels

Blank Labels by Size



DIN A4 Sheet Format
(8.26" x 11.69" / 210 mm x 297 mm)

Part Number	Material	Color	Label Width A In. (mm)	Label Length B In. (mm)	Horizontal Repeat D In. (mm)	Vertical Repeat E In. (mm)	No. of Col.	No. of Rows	Labels Per Sheet	Sheets Per Pkg	Std. Pkg. Qty*
PESS-SEL has Static Sensitive Warning printed on top half of label (see drawing below).											
PESS-SEL	Polyester	Yellow	1.00 (25.4)	0.50 (12.7)	1.00 (25.4)	0.50 (12.7)	7	22	154	33	2500
PEL-3-Y1-5	Polyester	Silver	1.44 (36.5)	0.25 (6.4)	1.44 (36.5)	0.25 (6.4)	5	45	225	23	5000
PEL-3-Y2-5	Polyester	White	1.44 (36.5)	0.25 (6.4)	1.44 (36.5)	0.25 (6.4)	5	45	225	23	5000
PEL-3-Y1C-5	Tamper Evident Polyester	Silver	1.44 (36.5)	0.25 (6.4)	1.44 (36.5)	0.25 (6.4)	5	45	225	23	5000
PEL-7-Y1-5	Polyester	Silver	1.50 (38.1)	0.33 (8.5)	1.50 (38.1)	0.33 (8.5)	5	33	165	31	5000
PEL-7-Y2-5	Polyester	White	1.50 (38.1)	0.33 (8.5)	1.50 (38.1)	0.33 (8.5)	5	33	165	31	5000
PEL-7-Y2Y-5	Polyester	Yellow	1.50 (38.1)	0.33 (8.5)	1.50 (38.1)	0.33 (8.5)	5	33	165	31	5000
PEL-7-Y3M-5	Polyester	Matte Clear	1.50 (38.1)	0.33 (8.5)	1.50 (38.1)	0.33 (8.5)	5	33	165	31	5000
PEL-12-Y1-2.5	Polyester	Silver	1.50 (38.1)	0.50 (12.7)	1.50 (38.1)	0.50 (12.7)	5	22	110	23	2500
PEL-12-Y2-2.5	Polyester	White	1.50 (38.1)	0.50 (12.7)	1.50 (38.1)	0.50 (12.7)	5	22	110	23	2500
PEL-12-Y2Y-2.5	Polyester	Yellow	1.50 (38.1)	0.50 (12.7)	1.50 (38.1)	0.50 (12.7)	5	22	110	23	2500
PEL-8-Y1-2.5	Polyester	Silver	2.00 (50.8)	0.33 (8.5)	2.00 (50.8)	0.33 (8.5)	3	33	99	26	2500
PEL-8-Y2-2.5	Polyester	White	2.00 (50.8)	0.33 (8.5)	2.00 (50.8)	0.33 (8.5)	3	33	99	26	2500
PEL-8-Y1C-2.5	Tamper Evident Polyester	Silver	2.00 (50.8)	0.33 (8.5)	2.00 (50.8)	0.33 (8.5)	3	33	99	26	2500
PEL-13-Y1-2.5	Polyester	Silver	2.00 (50.8)	0.50 (12.7)	2.00 (50.8)	0.50 (12.7)	3	22	66	38	2500
PEL-13-Y2-2.5	Polyester	White	2.00 (50.8)	0.50 (12.7)	2.00 (50.8)	0.50 (12.7)	3	22	66	38	2500
PEL-14-Y1-1	Polyester	Silver	2.00 (50.8)	0.83 (21.1)	2.00 (50.8)	0.83 (21.1)	3	13	39	26	1000
PEL-14-Y2-1	Polyester	White	2.00 (50.8)	0.83 (21.1)	2.00 (50.8)	0.83 (21.1)	3	13	39	26	1000
PEL-15-Y1-1	Polyester	Silver	2.00 (50.8)	1.00 (25.4)	2.00 (50.8)	1.00 (25.4)	3	11	33	31	1000
PEL-15-Y2-1	Polyester	White	2.00 (50.8)	1.00 (25.4)	2.00 (50.8)	1.00 (25.4)	3	11	33	31	1000
PEL-15-Y2Y-1	Polyester	Yellow	2.00 (50.8)	1.00 (25.4)	2.00 (50.8)	1.00 (25.4)	3	11	33	31	1000
PEL-15-Y1C-1	Tamper Evident Polyester	Silver	2.00 (50.8)	1.00 (25.4)	2.00 (50.8)	1.00 (25.4)	3	11	33	31	1000
PEL-16-Y1-0.5	Polyester	Silver	2.50 (63.5)	1.33 (33.8)	2.50 (63.5)	1.33 (33.9)	3	8	24	21	500
PEL-16-Y2-0.5	Polyester	White	2.50 (63.5)	1.33 (33.8)	2.50 (63.5)	1.33 (33.9)	3	8	24	21	500
PEL-16-Y1C-0.5	Tamper Evident Polyester	Silver	2.50 (63.5)	1.33 (33.8)	2.50 (63.5)	1.33 (33.9)	3	8	24	21	500
PEL-A4-Y1-25	Polyester	Silver	8.27 (210.0)	11.69 (297.0)	—	—	1	1	1	25	25
PEL-A4-Y2-25	Polyester	White	8.27 (210.0)	11.69 (297.0)	—	—	1	1	1	25	25
PEL-A4-Y2Y-25	Polyester	Yellow	8.27 (210.0)	11.69 (297.0)	—	—	1	1	1	25	25
PEL-A4-Y3-25	Polyester	Clear	8.27 (210.0)	11.69 (297.0)	—	—	1	1	1	25	25
PEL-A4-Y3M-25	Polyester	Matte Clear	8.27 (210.0)	11.69 (297.0)	—	—	1	1	1	25	25
PEL-A4-Y1C-25	Tamper Evident Polyester	Silver	8.27 (210.0)	11.69 (297.0)	—	—	1	1	1	25	25

Laser Labels

PESS-SEL



*Order number of labels required in multiples of Std. Pkg. Qty.

Dot-Matrix Labeling Products



Dot-Matrix Labels

Pages 80 to 121

- Available in three types to be used with Panduit PTR1 Dot-Matrix Printer (see **pg. 17**) or other dot-matrix printers
- Easy to align and user friendly
- Mark wires, circuit boards, bins and use for a wide variety of other labeling applications
- Choose from over 120 different sizes and 14 different materials



Dot-Matrix Heat Shrink Labels

Pages 122 to 123

- Heat Shrink Data Label Kits which allow user to create subsurface printed heat shrink markers without the use of special printers
- Full line of heat shrink tools and accessories for use with all Panduit heat shrink markers



Dot-Matrix Data Plates

Pages 124 to 125

- Non-adhesive tags to be used with Panduit PTR1 Dot-Matrix Printer (see **pg. 17**) or other dot-matrix printers
- Mark wires, cables, equipment, inventory and use for a wide variety of other applications where an adhesive label is not suitable
- Fasten Panduit Data Plates with Panduit Intermediate or Standard cross section cable ties



Indelible Ink Ribbons

Pages 126 to 128

- Used to print on non-porous materials to eliminate smearing
- Used on any material to reduce fading caused by exposure to UV rays



Marker Ties and Marker Plates

Pages 129 to 130

- Fasten and identify all types of wire and cable bundles at the same time

Dot-Matrix Labels – Introduction

Panduit Dot-Matrix Labels are used for a wide variety of identification purposes and are available in an extensive choice of materials, styles and sizes.

Features

- Widest selection of materials in the industry that provide weather and chemical resistance and withstand temperature extremes, radiation and UV exposure
- Most extensive choice of sizes and styles
- Compatible with your own computer equipment
- Eliminates the need for large inventories of custom labels

Benefits

- Labels to meet your most critical requirements
- A label is available for every application
- No waiting — produce as many labels as you need exactly when you need them
- Economical, cost effective

Choose from three types of Panduit Dot-Matrix Labels that are easy to align in your printer and easy to use:



Self-Laminating Labels

These labels are mainly used for marking wires and cables. Print on the white print-on area, then wrap the clear over-laminate over the legend to protect your legend.

Panduit Self-Laminating Labels are available in three materials. See [page 84](#) for complete material specifications.



Blank Labels

Panduit Blank Labels are used for a wide variety of applications from marking wires to identifying product through a wave solder process. Labels are produced in specific sizes for different applications.

See [page 84](#) for complete material specifications.



Litho Paper Labels

Used for permanent marking, Litho Paper Labels are made of paper with permanent adhesive. These Labels are available in common sizes and are frequently used for mailing, packaging and other high volume applications.

Suggested Applications for Dot-Matrix Labels



Marking Wires and Cables

Recommended Materials

Material	Color	Usage	Part Number Listing on Page
GMV3 Self-Laminating Vinyl	White / Clear	Indoor	85- 86
GMVF Self-Laminating Vinyl Free Polyolefin	White / Clear	Indoor	86
GMT1 Self-Laminating TEDLAR ^	White / Clear	Indoor / Outdoor	87
GMC Vinyl Cloth	White	Indoor	88-89
GMC-FR Flame Ret. Cloth	White	Indoor	90
GMP1 Destructible Paper	White	Indoor	91
GMV Vinyl	White	Indoor	92
GMT TEDLAR	White	Indoor / Outdoor	92-93



Flat Ribbon Cable Labeling

Recommended Materials

Material	Color	Usage	Part Number Listing on Page
GMV3 Self-Laminating Vinyl	White / Clear	Indoor	85- 86
GMVF Self-Laminating Vinyl Free Polyolefin	White / Clear	Indoor	86
GMT1 Self-Laminating TEDLAR	White / Clear	Indoor / Outdoor	87



Electronic Labeling

Recommended Materials

Material	Color	Usage	Part Number Listing on Page
GMC Vinyl Cloth	White	Indoor	88-89
GMK Polyimide	Amber	Indoor / High Temperature	90
GMP Removable Paper	White	Indoor	91
GMP1 Destructible Paper	White	Indoor	91
GMV Vinyl	White	Indoor	92
GMV10 Destructible Vinyl	White	Indoor	92
GMT TEDLAR	White	Indoor / Outdoor	92-93
GMV-C Polyester	Clear	Indoor / Outdoor	94
GMV-W Polyester	White	Indoor / Outdoor	94-95
GMV-S Polyester	Silver	Indoor / Outdoor	96



Terminal Block Labeling

Recommended Materials

Material	Color	Usage	Part Number Listing on Page
GMC Vinyl Cloth	White	Indoor	88-89
GMV Vinyl	White	Indoor	92
GMT TEDLAR	White	Indoor / Outdoor	92-93
GMV-W Polyester	White	Indoor / Outdoor	94-95

^TEDLAR is the registered trademark of E. I. DuPont Co.

Suggested Applications for Dot-Matrix Labels



Motor Control Labeling — Medium / High Temperature Applications

Recommended Materials

Material	Color	Usage	Part Number Listing on Page
GMV Vinyl	White	Indoor	92
GMY-C Polyester	Clear	Indoor / Outdoor	94
GMY-W Polyester	White	Indoor / Outdoor	94-95
GMY-S Polyester	Silver	Indoor / Outdoor	96



Bar Code Labeling

Recommended Materials

Material	Color	Usage	Part Number Listing on Page
GMP Removable Paper	White	Indoor	91
GMP1 Destructible Paper	White	Indoor	91
GMY-C Polyester	Clear	Indoor / Outdoor	94
GMY-W Polyester	White	Indoor / Outdoor	94-95



Bin Labels

Recommended Materials

Material	Color	Usage	Part Number Listing on Page
GMC Vinyl Cloth	White and Yellow	Indoor	88-89



Tamper Evident Labeling Applications

Recommended Materials

Material	Color	Usage	Part Number Listing on Page
GMP1 Destructible Paper	White	Indoor	91
GMV10 Destructible Vinyl	White	Indoor	92

Suggested Applications for Dot-Matrix Labels



Harsh Environment Labeling

Recommended Materials

Material	Color	Usage	Part Number Listing on Page
GMA Aluminum	Silver	Indoor	90
GMT TEDLAR *	White	Indoor / Outdoor	92-93
GMV-C Polyester	Clear	Indoor / Outdoor	94
GMV-W Polyester	White	Indoor / Outdoor	94-95
GMV-S Polyester	Silver	Indoor / Outdoor	96



Network Systems Labeling

Recommended Materials

Material	Color	Usage	Part Number Listing on Page
GMV3 Self-Laminating Vinyl	White / Clear	Indoor	97
GMT Self-Laminating TEDLAR	White / Clear	Indoor / Outdoor	97
GMV Vinyl	White	Indoor	98 - 100
GMPO Polyolefin	White	Indoor	98 - 100
GMV-C Polyester	Clear	Indoor / Outdoor	98 - 100
GMV-W Polyester	White	Indoor / Outdoor	98 - 100



Machinery Materials Identification

Recommended Materials

Material	Color	Usage	Part Number Listing on Page
GMC Vinyl Cloth	White and Yellow	Indoor	101



General Labeling

Recommended Materials

Material	Color	Usage	Part Number Listing on Page
Litho Paper	White	Indoor	103 - 105

*TEDLAR is the registered trademark of E. I. DuPont Co.

Dot-Matrix Label Material Selection Guide

Choose the material that best suits your application:

Self-Laminating Materials

Material Code	Material Type	Temperature Range	Key Features	Color	Outdoor Rated	Hazardous Environment	UL Rec	CSA
GMV3	Self-Laminating Vinyl	-40°F to 150°F (-40°C to 66°C)	Preferred material for most general wire and cable labeling; thin, conformable material	Clear w/ White Print-On Area	No	No	Yes	Yes
GMVF	Self-Laminating Vinyl Free Polyolefin	-20°F to 140°F (-29°C to 60°C)	Vinyl free material meets CONEG (No heavy metals) and European Market Requirements	Clear w/ White Print-On Area	No	No	No	No
GMT1	Self-Laminating TEDLAR *	0°F to 275°F (-18°C to 135°C)	Self-extinguishing, outdoor rated material; ideal for wire and cable labeling in harsh environments	Clear w/ White Print-On Area	Yes	Yes	Yes	Yes

Blank Materials

Material Code	Material Type	Temperature Range	Key Features	Color	Outdoor Rated	Hazardous Environment	UL Rec	CSA
—	Litho Paper	-65°F to 200°F (-54°C to 93°C)	Highly ink receptive material for economical printing in indoor applications	White	No	No	No	No
GMA	Aluminum	-65°F to 300°F (-54°C to 149°C)	Embossed legend ideal for rating plates; resistant to fungus, solvents, and high temperatures	Silver	No	Yes	Yes	Yes
GMC	Vinyl Cloth	-50°F to 170°F (-46°C to 77°C)	Repositionable adhesive allows label to be removed and reused or used in temporary applications	White	No	No	No	No
GMC-FR	Flame Retardant Cloth	-40°F to 250°F (-40°C to 121°C)	Polymer coated cloth for non-adhesive Rag Tag Labels; Flame retardant material meets U.L. 94-VTMO	White	No	No	No	No
GMK	Polyimide	-40°F to 350°F (-40°C to 177°C)	For applications requiring solvent and high temperature resistance, such as the wave solder process	Amber	No	Yes	Yes	No
GMP	Removable Paper	0°F to 120°F (-18°C to 49°C)	Removable adhesive is ideal for temporary marking; labels provide good contrast for bar code scanning	White	No	No	No	No
GMP1	Destructible Paper	-65°F to 200°F (-54°C to 93°C)	Label will destruct upon removal; for permanent and tamper resistant labeling applications	White	No	No	No	No
GMPO	Polyolefin	-50°F to 120°F (-46°C to 49°C)	Excellent print quality	White	No	No	No	No
GMV	Vinyl	-0°F to 170°F (-18°C to 77°C)	Low cost, conformable material for wire marking applications	White	No	No	Yes	Yes
GMV9	Semi-Rigid Vinyl	-20°F to 176°F (-29°C to 80°C)	Non-adhesive material for high quality tag and marker plate applications	White	No	No	No	No
GMV10	Destructible Vinyl	-65°F to 200°F (-54°C to 93°C)	Destructible material ideal for tamper evident applications; damages most surfaces upon removal of label	White	Yes	No	No	No
GMT	TEDLAR	-40°F to 275°F (-40°C to 135°C)	Self-extinguishing film for high quality indoor/outdoor, high temperature labels	White	Yes	Yes	Yes	Yes
GMV-C	Polyester	-40°F to 311°F (-40°C to 154°C)	Provides durability, high temperature resistance, and dimensional stability; Use on colored or clear surface	Clear	Yes	Yes	No	No
GMV-W	Polyester	-40°F to 311°F (-40°C to 154°C)	Provides durability, high temperature resistance, and dimensional stability	White	Yes	Yes	Yes	Yes
GMV-S	Polyester	-40°F to 311°F (-40°C to 154°C)	Metallized polyester provides opacity, durability, high temperature resistance, and dimensional stability	Silver	Yes	Yes	Yes	Yes

*TEDLAR is the registered trademark of E. I. DuPont Co.

Self-Laminating Labels by Material



GMV3 Self-Laminating Vinyl Labels - Indoor Applications

- Print on the white label area and over-laminate with clear portion for permanent, clean identification
- Preferred material chosen for most OEM and MRO wire marking applications
- Some sizes are available with a colored strip for group identification

Part Number	Material	Print-On Area Color	Label Size Width x Length In. (mm)	Print-On Area Width x Length In. (mm)	Nominal Cable Outside Diameter * In. (mm)	Dwg. Page No.	Std. Pkg. Qty.*
PDL-239	GMV3 Self-Laminating Vinyl	White	0.30 x 0.75 (7.6 x 19.1)	0.30 x 0.38 (7.6 x 9.5)	0.12 - 0.12 (3.0 - 3.0)	106	5000
PDL-241		White	0.30 x 0.94 (7.6 x 23.8)	0.30 x 0.38 (7.6 x 9.5)	0.12 - 0.18 (3.0 - 4.6)	106	5000
PDL-168		White	0.36 x 0.94 (9.1 x 23.8)	0.36 x 0.38 (9.14 x 9.5)		106	5000
PDL-117		White	0.50 x 0.75 (12.7 x 19.1)	0.50 x 0.38 (12.7 x 9.5)	0.12 - 0.12 (3.0 - 3.0)	106	5000
PDL-42		White	0.50 x 0.75 (12.7 x 19.1)	0.50 x 0.38 (12.7 x 9.5)		106	5000
PDL-42-10		White	0.50 x 0.75 (12.7 x 19.1)	0.50 x 0.38 (12.7 x 9.5)		106	10,000
PDL-243		White	0.50 x 0.94 (12.7 x 23.8)	0.50 x 0.38 (12.7 x 9.5)	0.12 - 0.18 (3.0 - 4.6)	106	5000
PDL-1-1		White	0.50 x 1.44 (12.7 x 36.5)	0.50 x 0.50 (12.7 x 12.7)	0.16 - 0.30 (4.0 - 7.6)	106	1000
PDL-1†		White	0.50 x 1.44 (12.7 x 36.5)	0.50 x 0.50 (12.7 x 12.7)		106	5000
PDL-1-10		White	0.50 x 1.44 (12.7 x 36.5)	0.50 x 0.50 (12.7 x 12.7)		106	10,000
PDL-12		White	0.50 x 1.44 (12.7 x 36.5)	0.50 x 0.50 (12.7 x 12.7)		106	5000
PDL-6556-2		White	0.60 x 1.44 (15.2 x 36.5)	0.60 x 0.50 (15.2 x 12.7)		106	5000
PDL-245-1		White	0.75 x 1.75 (19.1 x 44.5)	0.75 x 0.50 (19.1 x 12.7)		0.16 - 0.40 (4.0 - 10.1)	107
PDL-245		White	0.75 x 1.75 (19.1 x 44.5)	0.75 x 0.50 (19.1 x 12.7)	107		5000
PDL-245-10		White	0.75 x 1.75 (19.1 x 44.5)	0.75 x 0.50 (19.1 x 12.7)	107		10,000
PDL-247		White	0.80 x 0.94 (20.3 x 23.8)	0.80 x 0.38 (20.3 x 9.5)	0.12 - 0.18 (3.0 - 4.6)	107	5000
PDL-8-1		White	0.80 x 1.44 (20.3 x 36.5)	0.80 x 0.50 (20.3 x 12.7)	0.16 - 0.30 (4.0 - 7.6)	107	1000
PDL-8†		White	0.80 x 1.44 (20.3 x 36.5)	0.80 x 0.50 (20.3 x 12.7)		107	5000
PDL-8-10		White	0.80 x 1.44 (20.3 x 36.5)	0.80 x 0.50 (20.3 x 12.7)		107	10,000
PDL-5859-2		White	0.82 x 2.00 (20.8 x 50.8)	0.82 x 0.63 (20.8 x 15.9)	0.20 - 0.44 (5.1 - 11.1)	107	5000
PDL-5859-4		Yellow	0.82 x 2.00 (20.8 x 50.8)	0.82 x 0.63 (20.8 x 15.9)		107	5000
PDL-249-1		White	1.00 x 0.75 (25.4 x 19.1)	1.00 x 0.38 (25.4 x 9.5)	0.12 - 0.12 (3.0 - 3.0)	107	1000
PDL-249		White	1.00 x 0.75 (25.4 x 19.1)	1.00 x 0.38 (25.4 x 9.5)		107	5000
PDL-249-10		White	1.00 x 0.75 (25.4 x 19.1)	1.00 x 0.38 (25.4 x 9.5)		107	10,000
PDL-251		White	1.00 x 0.94 (25.4 x 23.8)	1.00 x 0.38 (25.4 x 9.5)	0.12 - 0.18 (3.0 - 4.6)	107	5000
PDL-2-1		White	1.00 x 1.44 (25.4 x 36.5)	1.00 x 0.50 (25.4 x 12.7)	0.16 - 0.30 (4.0 - 7.6)	108	1000
PDL-2†		White	1.00 x 1.44 (25.4 x 36.5)	1.00 x 0.50 (25.4 x 12.7)		108	5000
PDL-2-10		White	1.00 x 1.44 (25.4 x 36.5)	1.00 x 0.50 (25.4 x 12.7)		108	10,000
PDL-9025-10		White	1.00 x 1.44 (25.4 x 36.5)	1.00 x 0.62 (25.4 x 15.8)	0.20 - 0.26 (5.0 - 6.6)	108	10,000
PDL-4†		White	1.00 x 2.44 (25.4 x 61.9)	1.00 x 0.75 (25.4 x 19.1)	0.24 - 0.54 (6.1 - 13.7)	108	1000
PDL-4-10		White	1.00 x 2.44 (25.4 x 61.9)	1.00 x 0.75 (25.4 x 19.1)		108	10,000
PDL-6†		White	1.00 x 3.94 (25.4 x 100.1)	1.00 x 1.00 (25.4 x 25.4)	0.32 - 0.94 (8.1 - 23.8)	109	1000
PDL-6-2.5		White	1.00 x 3.94 (25.4 x 100.1)	1.00 x 1.00 (25.4 x 25.4)		109	2500
PDL-6-10		White	1.00 x 3.94 (25.4 x 100.1)	1.00 x 1.00 (25.4 x 25.4)		109	10,000
PDL-124		White	1.00 x 5.94 (25.4 x 150.9)	1.00 x 1.50 (25.4 x 38.1)	0.48 - 1.41 (12.1 - 35.9)	109	1000
PDL-124-2.5		White	1.00 x 5.94 (25.4 x 150.9)	1.00 x 1.50 (25.4 x 38.1)		109	2500
PDL-124-10		White	1.00 x 5.94 (25.4 x 150.9)	1.00 x 1.50 (25.4 x 38.1)		109	10,000
PDL-51		White	1.00 x 5.94 (25.4 x 150.9)	1.00 x 1.50 (25.4 x 38.1)		109	1000
PDL-126		White	1.00 x 7.44 (25.4 x 189.0)	1.00 x 1.50 (25.4 x 38.1)	0.48 - 1.89 (12.1 - 48.0)	109	1000
PDL-126-10		White	1.00 x 7.44 (25.4 x 189.0)	1.00 x 1.50 (25.4 x 38.1)		109	10,000
PDL-52		White	1.00 x 7.44 (25.4 x 189.0)	1.00 x 1.50 (25.4 x 38.1)		109	1000
PDL-52-2.5		White	1.00 x 7.44 (25.4 x 189.0)	1.00 x 1.50 (25.4 x 38.1)		109	2500

*Refer to Wire Size Selection Guide on page 196 to review diameters of commonly used cables

†Labels available with colored strip on left hand side of label; to order, add the following letter to part number: B for Blue, BR for Brown, G for Green, GR for Gray, OR for Orange, PR for Purple, R for Red, Y for Yellow.

More sizes shown on the following page

*Order number of labels required in multiples of Std. Pkg. Qty.

Self-Laminating Labels by Material (cont.)

GMV3 Self-Laminating Vinyl Labels - Indoor Applications (cont.)

Part Number	Material	Print-On Area Color	Label Size Width x Length In. (mm)	Print-On Area Width x Length In. (mm)	Nominal Cable Outside Diameter* In. (mm)	Dwg. Page No.	Std. Pkg. Qty.*
PDL-5859-1	GMV3 Self-Laminating Vinyl	White	1.13 x 3.75 (28.6 x 95.3)	1.13 x 1.25 (28.6 x 31.8)	0.40 - 0.80 (1.1 - 20.2)	109	5000
PDL-5859-3		Yellow	1.13 x 3.75 (28.6 x 95.3)	1.13 x 1.25 (28.6 x 31.8)		109	5000
CCS-WHT		White	1.17 x 3.00 (29.6 x 76.2)	1.17 x 0.83 (29.6 x 21.2)	0.26 - 0.69 (6.6 - 17.5)	109	5000
CCS-YEL		Yellow	1.17 x 3.00 (29.6 x 76.2)	1.17 x 0.83 (29.6 x 21.2)		109	5000
PDL-6626-10		White	1.20 x 2.25 (30.5 x 57.2)	1.20 x 0.60 (30.5 x 15.2)	0.19 - 0.53 (4.9 - 13.3)	109	10,000
PDL-3523-1		White	1.50 x 2.25 (38.1 x 57.2)	1.50 x 0.50 (38.1 x 12.7)	0.16 - 0.56 (4.0 - 14.2)	109	1000
PDL-361-1		White	1.50 x 3.63 (38.1 x 92.1)	1.50 x 0.80 (38.1 x 20.3)	0.25 - 0.90 (6.5 - 22.9)	109	1000
PDL-109		White	1.90 x 3.19 (48.3 x 81.0)	1.90 x 0.75 (48.3 x 19.1)	0.24 - 0.78 (6.1 - 19.7)	110	1000
PDL-109-2.5		White	1.90 x 3.19 (48.3 x 81.0)	1.90 x 0.75 (48.3 x 19.1)		110	2500
PDL-18		White	1.90 x 3.19 (48.3 x 81.0)	1.90 x 0.75 (48.3 x 19.1)		110	1000
PDL-18-2.5		White	1.90 x 3.19 (48.3 x 81.0)	1.90 x 0.75 (48.3 x 19.1)		110	2500
PDL-18-10		White	1.90 x 3.19 (48.3 x 81.0)	1.90 x 0.75 (48.3 x 19.1)		110	10,000
PDL-3-1		White	2.00 x 1.44 (50.8 x 36.5)	2.00 x 0.50 (50.8 x 12.7)		0.16 - 0.30 (4.0 - 7.6)	110
PDL-3†		White	2.00 x 1.44 (50.8 x 36.5)	2.00 x 0.50 (50.8 x 12.7)	110		5000
PDL-3-10		White	2.00 x 1.44 (50.8 x 36.5)	2.00 x 0.50 (50.8 x 12.7)	110		10,000
PDL-5†		White	2.00 x 2.44 (50.8 x 61.9)	2.00 x 0.75 (50.8 x 19.1)	0.24 - 0.54 (6.1 - 13.7)	110	1000
PDL-5-2.5		White	2.00 x 2.44 (50.8 x 61.9)	2.00 x 0.75 (50.8 x 19.1)		110	2500
PDL-5-10		White	2.00 x 2.44 (50.8 x 61.9)	2.00 x 0.75 (50.8 x 19.1)		110	10,000
PDL-7††		White	2.00 x 3.94 (50.8 x 100.1)	2.00 x 1.00 (50.8 x 25.4)	0.32 - 0.94 (8.1 - 23.8)	111	1000
PDL-7-2.5		White	2.00 x 3.94 (50.8 x 100.1)	2.00 x 1.00 (50.8 x 25.4)		111	2500
PDL-7-10		White	2.00 x 3.94 (50.8 x 100.1)	2.00 x 1.00 (50.8 x 25.4)		111	10,000
PDL-133		White	2.00 x 5.94 (50.8 x 150.9)	2.00 x 1.50 (50.8 x 38.1)	0.48 - 1.41 (12.1 - 35.9)	111	1000
PDL-16		White	2.00 x 5.94 (50.8 x 150.9)	2.00 x 1.50 (50.8 x 38.1)		111	1000
PDL-16-2.5		White	2.00 x 5.94 (50.8 x 150.9)	2.00 x 1.50 (50.8 x 38.1)		111	2500
PDL-16-10		White	2.00 x 5.94 (50.8 x 150.9)	2.00 x 1.50 (50.8 x 38.1)		111	10,000
PDL-115		White	2.00 x 7.44 (50.8 x 189.0)	2.00 x 1.50 (50.8 x 38.1)	0.48 - 1.89 (12.1 - 48.0)	111	1000
PDL-115-2.5		White	2.00 x 7.44 (50.8 x 189.0)	2.00 x 1.50 (50.8 x 38.1)		111	2500
PDL-17		White	2.00 x 7.44 (50.8 x 189.0)	2.00 x 1.50 (50.8 x 38.1)		111	1000
PDL-17-2.5		White	2.00 x 7.44 (50.8 x 189.0)	2.00 x 1.50 (50.8 x 38.1)		111	2500
PDL-362-1		White	2.00 x 9.00 (50.8 x 228.6)	2.00 x 1.50 (50.8 x 38.1)		0.48 - 2.39 (12.1 - 60.7)	111

*Refer to Wire Size Selection Guide on page 196 to review diameters of commonly used cables
 †Labels available with colored strip on left hand side of label; to order, add the following letter to part number: B for Blue, BR for Brown, G for Green, GR for Gray, OR for Orange, PR for Purple, R for Red, Y for Yellow.
 ††Labels available with colored strip on left hand side of label; to order, add the following letter to part number: B for Blue, G for Green, R for Red, Y for Yellow.



GMVF Self-Laminating Vinyl Free Polyolefin Labels - Indoor Applications

- Environmentally friendly material
- Material meets European Market Requirements (no heavy metals)

Part Number	Material	Print-On Area Color	Label Size Width x Length In. (mm)	Print-On Area Width x Length In. (mm)	Nominal Cable Outside Diameter* In. (mm)	Dwg. Page No.	Std. Pkg. Qty.*
PDL-239VF	GMVF Self-Laminating Vinyl Free	White	0.30 x 0.75 (7.6 x 19.1)	0.30 x 0.38 (7.6 x 9.5)	0.12 - 0.12 (3.0 - 3.0)	106	5000
PDL-1VF		White	0.50 x 1.44 (12.7 x 36.5)	0.50 x 0.50 (12.7 x 12.7)		0.16 - 0.30 (4.0 - 7.6)	106
PDL-8VF		White	0.80 x 1.44 (20.3 x 36.5)	0.80 x 0.50 (20.3 x 12.7)	107		5000
PDL-249VF		White	1.00 x 0.75 (25.4 x 19.1)	1.00 x 0.38 (25.4 x 9.5)	107		5000
PDL-2VF		White	1.00 x 1.44 (25.4 x 36.5)	1.00 x 0.50 (25.4 x 12.7)	0.16 - 0.30 (4.0 - 7.6)	108	5000
PDL-4VF		White	1.00 x 2.44 (25.4 x 61.9)	1.00 x 0.75 (25.4 x 19.1)	0.24 - 0.54 (6.1 - 13.7)	108	1000
PDL-6VF		White	1.00 x 3.94 (25.4 x 100.1)	1.00 x 1.00 (25.4 x 25.4)	0.32 - 0.94 (8.1 - 23.8)	109	1000
PDL-3VF		White	2.00 x 1.44 (50.8 x 36.5)	2.00 x 0.50 (50.8 x 12.7)	0.16 - 0.30 (4.0 - 7.6)	110	5000
PDL-5VF-10		White	2.00 x 2.44 (50.8 x 61.9)	2.00 x 0.75 (50.8 x 19.1)	0.24 - 0.54 (6.1 - 13.7)	110	10,000
PDL-7VF		White	2.00 x 3.94 (50.8 x 100.1)	2.00 x 1.00 (50.8 x 25.4)	0.32 - 0.94 (8.1 - 23.8)	111	1000

*Refer to Wire Size Selection Guide on page 196 to review diameters of commonly used cables

Self-Laminating Labels by Material (cont.)



GMT1 Self-Laminating TEDLAR[▲] Labels - Indoor / Outdoor Applications

- Preferred material for construction, utility and high temperature applications
- Self-extinguishing and exceeds 94V-0 flammability requirements
- Some sizes are available with a colored strip for group identification
- Use with Panduit Indelible Ink Ribbons found on [pages 126 - 128](#)

Part Number	Material	Print-On Area Color	Label Size Width x Length In. (mm)	Print-On Area Width x Length In. (mm)	Nominal Cable Outside Diameter [■] In. (mm)	Dwg. Page No.	Std. Pkg. Qty.*
PDL-238	GMT1 Self-Laminating TEDLAR [▲]	White	0.30 x 0.75 (7.6 x 19.1)	0.30 x 0.38 (7.6 x 9.5)	0.12 - 0.12 (3.0 - 3.0)	106	5000
PDL-240		White	0.30 x 0.94 (7.6 x 23.8)	0.30 x 0.38 (7.6 x 9.5)	0.12 - 0.18 (3.0 - 4.6)	106	5000
PDL-169		White	0.36 x 0.94 (9.14 x 23.8)	0.36 x 0.38 (9.14 x 9.5)		106	5000
PDL-118-1		White	0.50 x 0.75 (12.7 x 19.1)	0.50 x 0.38 (12.7 x 9.5)	0.12 - 0.12 (3.0 - 3.0)	106	1000
PDL-118		White	0.50 x 0.75 (12.7 x 19.1)	0.50 x 0.38 (12.7 x 9.5)		106	5000
PDL-118-10		White	0.50 x 0.75 (12.7 x 19.1)	0.50 x 0.38 (12.7 x 9.5)		106	10,000
PDL-88		White	0.50 x 0.75 (12.7 x 19.1)	0.50 x 0.38 (12.7 x 9.5)		106	5000
PDL-242		White	0.50 x 0.94 (12.7 x 23.8)	0.50 x 0.38 (12.7 x 9.5)	0.12 - 0.18 (3.0 - 4.6)	106	5000
PDL-53†		White	0.50 x 1.38 (12.7 x 34.9)	0.50 x 0.50 (12.7 x 12.7)	0.16 - 0.28 (4.0 - 7.1)	106	5000
PDL-53-10		White	0.50 x 1.38 (12.7 x 34.9)	0.50 x 0.50 (12.7 x 12.7)		106	10,000
PDL-61		White	0.50 x 1.44 (12.7 x 36.5)	0.50 x 0.50 (12.7 x 12.7)	0.16 - 0.30 (4.0 - 7.6)	106	5000
PDL-244		White	0.75 x 1.75 (19.1 x 44.5)	0.75 x 0.50 (19.1 x 12.7)	0.16 - 0.40 (4.0 - 10.1)	107	5000
PDL-246		White	0.80 x 0.94 (20.3 x 23.8)	0.80 x 0.38 (20.3 x 9.5)	0.12 - 0.18 (3.0 - 4.6)	107	5000
PDL-60†		White	0.80 x 1.44 (20.3 x 36.5)	0.80 x 0.50 (20.3 x 12.7)	0.16 - 0.30 (4.0 - 7.6)	107	5000
PDL-248		White	1.00 x 0.75 (25.4 x 19.1)	1.00 x 0.38 (25.4 x 9.5)	0.12 - 0.12 (3.0 - 3.0)	107	5000
PDL-250		White	1.00 x 0.94 (25.4 x 23.8)	1.00 x 0.38 (25.4 x 9.5)	0.12 - 0.18 (3.0 - 4.6)	107	5000
PDL-54†		White	1.00 x 1.38 (25.4 x 34.9)	1.00 x 0.50 (25.4 x 12.7)	0.16 - 0.28 (4.0 - 7.1)	108	5000
PDL-56†		White	1.00 x 2.44 (25.4 x 61.9)	1.00 x 0.75 (25.4 x 19.1)	0.24 - 0.54 (6.1 - 13.7)	108	1000
PDL-58†		White	1.00 x 3.87 (25.4 x 98.3)	1.00 x 1.00 (25.4 x 25.4)	0.32 - 0.91 (8.1 - 23.2)	109	1000
PDL-123		White	1.00 x 5.94 (25.4 x 150.9)	1.00 x 1.50 (25.4 x 38.1)	0.48 - 1.41 (12.1 - 35.9)	109	1000
PDL-95		White	1.00 x 5.94 (25.4 x 150.9)	1.00 x 1.50 (25.4 x 38.1)		109	1000
PDL-125		White	1.00 x 7.44 (25.4 x 189.0)	1.00 x 1.50 (25.4 x 38.1)	0.48 - 1.89 (12.1 - 48.0)	109	1000
PDL-96		White	1.00 x 7.44 (25.4 x 189.0)	1.00 x 1.50 (25.4 x 38.1)		109	1000
PDL-108		White	1.90 x 3.19 (48.3 x 81.0)	1.90 x 0.75 (48.3 x 19.1)		0.24 - 0.78 (6.1 - 19.7)	110
PDL-64		White	1.90 x 3.19 (48.3 x 81.0)	1.90 x 0.75 (48.3 x 19.1)	110		1000
PDL-55†		White	2.00 x 1.38 (50.8 x 34.9)	2.00 x 0.50 (50.8 x 12.7)	0.16 - 0.28 (4.0 - 7.1)	110	5000
PDL-57†		White	2.00 x 2.44 (50.8 x 61.9)	2.00 x 0.75 (50.8 x 19.1)	0.24 - 0.54 (6.1 - 13.7)	110	1000
PDL-59†		White	2.00 x 3.87 (50.8 x 98.3)	2.00 x 1.00 (50.8 x 25.4)	0.32 - 0.91 (8.1 - 23.2)	111	1000
PDL-59-10		White	2.00 x 3.87 (50.8 x 98.3)	2.00 x 1.00 (50.8 x 25.4)		111	10,000
PDL-134		White	2.00 x 5.94 (50.8 x 150.9)	2.00 x 1.50 (50.8 x 38.1)	0.48 - 1.41 (12.1 - 35.9)	111	1000
PDL-62		White	2.00 x 5.94 (50.8 x 150.9)	2.00 x 1.50 (50.8 x 38.1)		111	1000
PDL-116		White	2.00 x 7.44 (50.8 x 189.0)	2.00 x 1.50 (50.8 x 38.1)	0.48 - 1.89 (12.1 - 48.0)	111	1000
PDL-63		White	2.00 x 7.44 (50.8 x 189.0)	2.00 x 1.50 (50.8 x 38.1)		111	1000

*Refer to Wire Size Selection Guide on [page 196](#) to review diameters of commonly used cables

†Labels available with colored strip on left hand side of label; to order, add the following letter to part number: B for Blue, BR for Brown, G for Green, GR for Gray, OR for Orange, PR for Purple, R for Red, Y for Yellow.

▲TEDLAR is the registered trademark of E. I. DuPont Co.

Blank Labels by Material



Wire Marking

- Can be used as a wrap around label or flag marker
- Unique adhesive allows label to be removed, repositioned and reused
- User places the label on a loose wire, removes the label to terminate the wire and then places label back on the terminated wire
- Ideal for panel building applications
- Use with Panduit Indelible Ink Ribbons found on [pages 126 - 128](#)



Terminal Block Marking

- Ideal for temporary marking of terminal blocks
- Label can be removed without leaving any adhesive residue
- Labels can be re-applied several times due to unique adhesive

GMC Vinyl Cloth - Indoor Applications

Part Number	Material	Color	Label Size Width x Length In. (mm)	Dwg. Page No.	Std. Pkg. Qty.*
PDL-176	GMC Vinyl Cloth	White	0.25 x 1.44 (6.4 x 36.6)	112	5000
PDL-347		White	0.28 x 0.25 (7.1 x 6.4)•	112	1 Roll (28,000 Labels)
PDL-254		White	0.30 x 0.75 (7.6 x 19.1)	112	5000
PDL-257		White	0.30 x 0.94 (7.6 x 23.8)	112	5000
PDL-351		White	0.31 x 0.38 (7.9 x 9.5)•	112	1 Roll (18,670 Labels)
PDL-353		White	0.31 x 0.50 (7.9 x 12.7)•	112	1 Roll (14,000 Labels)
PDL-349		White	0.31 x 700 (7.9 x 17780)•	112	1 Roll (10 Labels)
PDL-260		White	0.38 x 0.38 (9.5 x 9.5)	112	5000
PDL-180		White	0.38 x 1.44 (9.5 x 36.6)	112	5000
PDL-355		White	0.38 x 700 (9.5 x 17780)•	112	1 Roll (8 Labels)
PDL-102		White	0.44 x 2.56 (11.1 x 65.0)	112	5000
PDL-106-1		White	0.44 x 3.63 (11.1 x 92.1)	113	1000
PDL-106		White	0.44 x 3.63 (11.1 x 92.1)	113	5000
PDL-106-10		White	0.44 x 3.63 (11.1 x 92.1)	113	10,000
PDL-45-1		White	0.50 x 0.44 (12.7 x 11.1)	113	1000
PDL-45		White	0.50 x 0.44 (12.7 x 11.1)	113	5000
PDL-45-10		White	0.50 x 0.44 (12.7 x 11.1)	113	10,000
PDL-119		White	0.50 x 0.75 (12.7 x 19.1)	113	5000
PDL-43		White	0.50 x 0.75 (12.7 x 19.1)	113	5000
PDL-43-10		White	0.50 x 0.75 (12.7 x 19.1)	113	10,000
PDL-265		White	0.50 x 0.94 (12.7 x 23.8)	113	5000
PDL-13-1		White	0.50 x 1.44 (12.7 x 36.5)	113	1000
PDL-13		White	0.50 x 1.44 (12.7 x 36.5)	113	5000
PDL-13-10		White	0.50 x 1.44 (12.7 x 36.5)	113	10,000
PDL-184		White	0.50 x 1.44 (12.7 x 36.5)	113	5000
PDL-135		White	0.50 x 1.44 (12.7 x 36.5) With Horizontal Slit	114	5000
PDL-193		Yellow	0.59 x 0.35 (15.0 x 9.0)	114	5000
PDL-194		White	0.59 x 0.35 (15.0 x 9.0)	114	5000
PDL-34-1		White	0.65 x 0.20 (16.5 x 5.1)	114	1000
PDL-34		White	0.65 x 0.20 (16.5 x 5.1)	114	5000
PDL-34-10		White	0.65 x 0.20 (16.5 x 5.1)	114	10,000
PDL-270		White	0.75 x 0.25 (19.1 x 6.4)	115	5000
PDL-37-1		White	0.75 x 0.25 (19.1 x 6.4)	115	1000
PDL-37		White	0.75 x 0.25 (19.1 x 6.4)	115	5000
PDL-37-10		White	0.75 x 0.25 (19.1 x 6.4)	115	10,000
PDL-37-50		White	0.75 x 0.25 (19.1 x 6.4)	115	50,000
PDL-191		Yellow	0.79 x 0.32 (20.0 x 8.0)	115	5000
PDL-192		White	0.79 x 0.32 (20.0 x 8.0)	115	5000
PDL-280		White	0.80 x 0.94 (20.3 x 23.8)	116	5000
PDL-280-10		White	0.80 x 0.94 (20.3 x 23.8)	116	10,000
PDL-9	White	0.80 x 1.44 (20.3 x 36.5)	116	5000	
PDL-9-10	White	0.80 x 1.44 (20.3 x 36.5)	116	10,000	
PDL-9-10T•	White	0.80 x 1.44 (20.3 x 36.5)	116	10,000	
PDL-66	White	0.90 x 0.25 (22.9 x 6.4)	116	5000	
PDL-93	White	0.90 x 0.25 (22.9 x 6.4)	116	5000	
PDL-30-1	White	1.00 x 0.38 (25.4 x 9.5)	116	1000	
PDL-30	White	1.00 x 0.38 (25.4 x 9.5)	116	5000	
PDL-30-10	White	1.00 x 0.38 (25.4 x 9.5)	116	10,000	

More sizes shown on the following page

Blank Labels by Material (cont.)



Electronic Labeling

- Ideal for temporary marking of chips, boards or IC's
- Label is removable without leaving any adhesive residue
- Labels can be re-applied several times due to unique adhesive
- Pliable material is good for rough texture surfaces



Bin Marking

- Unique adhesive allows label to be removed, repositioned and reused — ideal for stock room changes
- Pliable material good for rough textured surfaces, such as concrete

GMC Vinyl Cloth - Indoor Applications (cont.)

Part Number	Material	Color	Label Size Width x Length In. (mm)	Dwg. Page No.	Std. Pkg. Qty.*
PDL-19-1	GMC Vinyl Cloth	White	1.00 x 0.50 (25.4 x 12.7)	117	1000
PDL-19		White	1.00 x 0.50 (25.4 x 12.7)	117	5000
PDL-19-10		White	1.00 x 0.50 (25.4 x 12.7)	117	10,000
PDL-288		White	1.00 x 0.75 (25.4 x 19.1)	117	5000
PDL-291		White	1.00 x 0.94 (25.4 x 23.8)	117	5000
PDL-294		White	1.00 x 1.44 (25.4 x 36.5) With Horizontal Perforation	117	5000
PDL-4674-1		White	1.13 x 0.53 (28.6 x 13.5)	117	20,000
PDL-130		White	1.25 x 0.38 (31.8 x 9.5)	118	5000
PDL-69		White	1.25 x 0.38 (31.8 x 9.5)	118	5000
PDL-360-10		White	1.50 x 0.25 (38.1 x 6.4) With Vertical Perforation	118	10,000
PDL-41-1		White	1.50 x 0.25 (38.1 x 6.4) With Vertical Perforation	118	1000
PDL-41		White	1.50 x 0.25 (38.1 x 6.4) With Vertical Perforation	118	5000
PDL-41-10		White	1.50 x 0.25 (38.1 x 6.4) With Vertical Perforation	118	10,000
PDL-72		White	1.50 x 0.75 (38.1 x 19.1)	119	5000
PDL-297		Yellow	1.50 x 0.90 (38.1 x 22.9)	119	1000
PDL-298		White	1.50 x 0.90 (38.1 x 22.9)	119	1000
PDL-114		White	2.00 x 0.38 (50.8 x 9.5)	119	5000
PDL-32-1		White	2.00 x 0.38 (50.8 x 9.5)	119	1000
PDL-32		White	2.00 x 0.38 (50.8 x 9.5)	119	5000
PDL-32-10		White	2.00 x 0.38 (50.8 x 9.5)	119	10,000
PDL-147		White	2.00 x 1.25 (50.8 x 31.8)	119	1000
PDL-164		White	2.80 x 1.00 (71.1 x 25.4)	120	1000
PDL-166		White	2.80 x 1.50 (71.1 x 38.1)	120	1000
PDL-33		White	3.00 x 0.38 (76.2 x 9.5)	120	5000
PDL-307		Yellow	3.00 x 0.90 (76.2 x 22.9)	120	1000
PDL-308		White	3.00 x 0.90 (76.2 x 22.9)	120	1000
PDL-142		White	3.00 x 2.00 (76.2 x 50.8)	120	1000
PDL-153		White	3.25 x 1.25 (82.6 x 31.8)	120	1000
PDL-160		White	3.63 x 1.00 (92.1 x 25.4)	121	5000
PDL-162		White	3.63 x 1.50 (92.1 x 38.1)	121	5000
PDL-321		Yellow	3.90 x 0.90 (99.1 x 22.9)	121	1000
PDL-322		White	3.90 x 0.90 (99.1 x 22.9)	121	1000
PDL-323		Yellow	3.90 x 1.44 (99.1 x 36.5)	121	1000
PDL-324		White	3.90 x 1.44 (99.1 x 36.5)	121	1000
PDL-329		Yellow	3.90 x 2.90 (99.1 x 73.7)	121	1000
PDL-330		White	3.90 x 2.90 (99.1 x 73.7)	121	1000
PDL-331		Yellow	6.00 x 0.90 (152.4 x 22.9)	121	1000
PDL-332		White	6.00 x 0.90 (152.4 x 22.9)	121	1000
PDL-333		Yellow	6.00 x 1.44 (152.4 x 36.6)	121	1000
PDL-334		White	6.00 x 1.44 (152.4 x 36.6)	121	1000
PDL-335		Yellow	6.00 x 1.90 (152.4 x 48.3)	121	1000
PDL-336		White	6.00 x 1.90 (152.4 x 48.3)	121	1000
PDL-337	Yellow	6.00 x 2.90 (152.4 x 73.7)	121	1000	
PDL-338	White	6.00 x 2.90 (152.4 x 73.7)	121	1000	
PDL-341	Yellow	8.00 x 1.44 (203.2 x 36.5)	121	1000	
PDL-342	White	8.00 x 1.44 (203.2 x 36.5)	121	1000	
PDL-343	Yellow	12.00 x 1.90 (304.8 x 48.3)	121	1000	
PDL-344	White	12.00 x 1.90 (304.8 x 48.3)	121	1000	
PDL-345	Yellow	12.00 x 2.90 (304.8 x 73.7)	121	1000	
PDL-346	White	12.00 x 2.90 (304.8 x 73.7)	121	1000	

*Order number of labels required in multiples of Std. Pkg. Qty.

Blank Labels by Material (cont.)

- Resistant to solvents and high temperatures
- Use with Panduit Indelible Ink Ribbons found on [pages 126 - 128](#)

GMA Aluminum - Indoor Applications

Part Number	Material	Color	Label Size Width x Length In. (mm)	Dwg. Page No.	Std. Pkg. Qty.*
PDL-97	GMA Aluminum	Silver	1.00 x 0.50 (25.4 x 12.7)	117	5000
PDL-148		Silver	2.00 x 1.25 (50.8 x 31.8)	119	1000
PDL-143		Silver	3.00 x 2.00 (76.2 x 50.8)	120	1000
PDL-154		Silver	3.25 x 1.25 (82.6 x 31.8)	120	1000



GMC-FR Rag Tag Label (Non-Adhesive with Liner) -Indoor Applications

Part Number	Material	Color	Label Size In. (mm)				Labels Per Roll	Std. Pkg. Qty.*
			A	B	C	D		
PDL-500	GMC-FR Flame Retardant Cloth	White	4.50 (114.3)	1.00 (25.4)	0.50 (12.7)	2.25 (57.1)	1800	1 Roll



- Used for harness identification
- Will not damage wires or cable with adhesive residue
- Flame retardant GMC-FR material meets U.L. 94-VTM0
- IBM Approval LER440



GMK Polyimide - Indoor Applications

Part Number	Material	Color	Label Size Width x Length In. (mm)	Dwg. Page No.	Std. Pkg. Qty.*
PDL-252	GMK Polyimide	Amber	0.30 x 0.30 (7.6 x 7.6)	112	5000
PDL-252-10		Amber	0.30 x 0.30 (7.6 x 7.6)	112	10,000
PDL-262		Amber	0.38 x 0.38 (9.5 x 9.5)	112	5000
PDL-262-10		Amber	0.38 x 0.38 (9.5 x 9.5)	112	10,000
PDL-233		Amber	0.65 x 0.20 (16.5 x 5.1)	114	5000
PDL-233-10		Amber	0.65 x 0.20 (16.5 x 5.1)	114	10,000
PDL-235		Amber	0.75 x 0.25 (19.1 x 6.4)	115	5000
PDL-235-10		Amber	0.75 x 0.25 (19.1 x 6.4)	115	10,000
PDL-272		Amber	0.75 x 0.25 (19.1 x 6.4)	115	5000
PDL-276		Amber	0.75 x 0.25 (19.1 x 6.4) With Tamper Resistant Slits	115	5000
PDL-278		Amber	0.80 x 0.20 (20.3 x 5.1)	115	5000
PDL-173		Amber	0.80 x 0.50 (20.3 x 12.7)	115	5000
PDL-283		Amber	0.90 x 0.25 (22.9 x 6.4)	116	5000
PDL-50		Amber	0.90 x 0.25 (22.9 x 6.4)	116	5000
PDL-50-10		Amber	0.90 x 0.25 (22.9 x 6.4)	116	10,000
PDL-286		Amber	0.90 x 0.25 (22.9 x 6.4) With Tamper Resistant Slits	116	5000
PDL-98		Amber	1.00 x 0.50 (25.4 x 12.7)	117	5000
PDL-357		Amber	1.50 x 0.25 (38.1 x 6.4)	118	5000
PDL-237		Amber	2.00 x 0.38 (50.8 x 9.5)	119	5000
PDL-232		Amber	3.00 x 0.38 (76.2 x 9.5)	120	5000

- Can withstand high temperatures, ideal for components in direct contact with molten solder
- Resistant to most solvent washes
- Meets MIL Spec 202F
- Use with Panduit Indelible Ink Ribbons found on [pages 126 - 128](#)
- Polyimide is commonly called KAPTON*

* KAPTON is a registered trademark of E. I. DuPont Co.

Blank Labels by Material (cont.)

- Ideal for temporary labeling
- Low cost identification on boards and chips
- Labels provide good contrast for easy bar code scanning

GMP Removable Paper - Indoor Applications

Part Number	Material	Color	Label Size Width x Length In. (mm)	Dwg. Page No.	Std. Pkg. Qty.*
PDL-91	GMP Removable Paper	White	0.50 x 0.44 (12.7 x 11.1)	113	5000
PDL-170		White	0.80 x 0.50 (20.3 x 12.7)	115	5000
PDL-170-10		White	0.80 x 0.50 (20.3 x 12.7)	115	10,000
PDL-65		White	1.00 x 0.50 (25.4 x 12.7)	117	5000
PDL-359-10		White	1.50 x 0.25 (38.1 x 6.4) With Vertical Perforation	118	10,000
PDL-40		White	1.50 x 0.25 (38.1 x 6.4) With Vertical Perforation	118	5000
PDL-40-10		White	1.50 x 0.25 (38.1 x 6.4) With Vertical Perforation	118	10,000
PDL-299		White	2.00 x 0.90 (50.8 x 22.9)	119	1000
PDL-303		White	2.00 x 1.44 (50.8 x 36.5)	120	1000
PDL-309		White	3.00 x 0.90 (76.2 x 22.9)	120	1000
PDL-313		White	3.00 x 1.44 (76.2 x 36.5)	120	1000
PDL-317		White	3.00 x 1.90 (76.2 x 48.3)	120	1000
PDL-325		White	3.90 x 1.44 (99.1 x 36.5)	120	1000
PDL-339		White	6.00 x 3.94 (152.4 x 100.0)	121	1000



- Strong permanent adhesive will leave traces of label after removal
- Low cost identification on board and chips
- Good contrast for easy bar code scanning

GMP1 Destructible Paper - Indoor Applications

Part Number	Material	Color	Label Size Width x Length In. (mm)	Dwg. Page No.	Std. Pkg. Qty.*
PDL-122	GMP1 Destructible Paper	White	0.50 x 0.75 (12.7 x 19.1)	113	5000
PDL-89		White	0.50 x 0.75 (12.7 x 19.1)	113	5000
PDL-138		White	0.50 x 1.44 (12.7 x 36.5) With Horizontal Slit	114	5000
PDL-82		White	0.65 x 0.20 (16.5 x 5.1)	114	5000
PDL-85		White	0.75 x 0.25 (19.1 x 6.4)	115	5000
PDL-167		White	0.80 x 0.25 (20.3 x 6.4)	115	5000
PDL-174		White	0.80 x 0.50 (20.3 x 12.7)	115	5000
PDL-67		White	0.90 x 0.25 (22.9 x 6.4)	116	5000
PDL-92		White	0.90 x 0.25 (22.9 x 6.4)	116	5000
PDL-74		White	1.00 x 0.38 (25.4 x 9.5)	116	5000
PDL-370		White	1.25 x 0.38 (31.8 x 9.5)	118	5000
PDL-70		White	1.25 x 0.38 (31.8 x 9.5)	118	5000
PDL-73		White	1.50 x 0.75 (38.1 x 19.1)	119	5000
PDL-73-10		White	1.50 x 0.75 (38.1 x 19.1)	119	10,000
PDL-112		White	2.00 x 0.38 (50.8 x 9.5)	119	5000
PDL-78		White	2.00 x 0.38 (50.8 x 9.5)	119	5000
PDL-300		White	2.00 x 0.90 (50.8 x 22.9)	119	1000
PDL-149		White	2.00 x 1.25 (50.8 x 31.8)	119	1000
PDL-304		White	2.00 x 1.44 (50.8 x 36.5)	120	1000
PDL-163		White	2.80 x 1.00 (71.1 x 25.4)	120	1000
PDL-165		White	2.80 x 1.50 (71.1 x 38.1)	120	1000
PDL-81		White	3.00 x 0.38 (76.2 x 9.5)	120	5000
PDL-310		White	3.00 x 0.90 (76.2 x 22.9)	120	1000
PDL-314		White	3.00 x 1.44 (76.2 x 36.5)	120	1000
PDL-318		White	3.00 x 1.90 (76.2 x 48.3)	120	1000
PDL-141		White	3.00 x 2.00 (76.2 x 50.8)	120	1000
PDL-155		White	3.25 x 1.25 (82.6 x 31.8)	120	1000
PDL-159		White	3.63 x 1.00 (92.1 x 25.4)	121	5000
PDL-161		White	3.63 x 1.50 (92.1 x 38.1)	121	5000
PDL-326		White	3.90 x 1.44 (99.1 x 36.5)	121	1000
PDL-340		White	6.00 x 3.94 (152.4 x 100.0)	121	1000

*Order number of labels required in multiples of Std. Pkg. Qty.

Blank Labels by Material (cont.)



- Economical
- Can be used for wire marking as a wrap around label or flag marker
- Use with Panduit Indelible Ink Ribbons found on **pages 126 - 128**

GMV Vinyl - Indoor Applications

Part Number	Material	Color	Label Size Width x Length In. (mm)	Dwg. Page No.	Std. Pkg. Qty.*
PDL-178	GMV Vinyl	White	0.25 x 1.44 (6.4 x 36.6)	112	5000
PDL-182		White	0.38 x 1.44 (9.5 x 36.6)	112	5000
PDL-103		White	0.44 x 2.56 (11.1 x 65.0)	112	5000
PDL-107		White	0.44 x 3.63 (11.1 x 92.1)	113	5000
PDL-15		White	0.50 x 1.44 (12.7 x 36.5)	113	5000
PDL-186		White	0.50 x 1.44 (12.7 x 36.5)	113	5000
PDL-189		White	0.65 x 0.20 (16.5 x 5.1)	114	5000
PDL-190		White	0.75 x 0.25 (19.1 x 6.4)	115	5000
PDL-171		White	0.80 x 0.50 (20.3 x 12.7)	115	5000
PDL-11		White	0.80 x 1.44 (20.3 x 36.5)	116	5000
PDL-188		White	1.00 x 0.50 (25.4 x 12.7)	117	5000
PDL-132		White	1.25 x 0.38 (31.8 x 9.5)	118	5000
PDL-132-10		White	1.25 x 0.38 (31.8 x 9.5)	118	10,000
PDL-629		White	1.50 x 0.25 (38.1 x 6.4) With Vertical Perforation	118	5000
PDL-113		White	2.00 x 0.38 (50.8 x 9.5)	119	5000
PDL-146		White	2.00 x 1.25 (50.8 x 31.8)	119	1000
PDL-140		White	3.00 x 2.00 (76.2 x 50.8)	120	1000
PDL-152		White	3.25 x 1.25 (82.6 x 31.8)	120	1000



- Strong permanent adhesive, destructible material
- Tamper evident and hard to remove
- Damages most surfaces upon removal of label

GMV10 Destructible Vinyl - Indoor Applications

Part Number	Material	Color	Label Size Width x Length In. (mm)	Dwg. Page No.	Std. Pkg. Qty.*
PDL-263	GMV10 Destructible Vinyl	White	0.38 x 0.38 (9.5 x 9.5)	112	5000
PDL-46		White	0.50 x 0.44 (12.7 x 11.1)	113	5000
PDL-35-1		White	0.65 x 0.20 (16.5 x 5.1)	114	1000
PDL-35		White	0.65 x 0.20 (16.5 x 5.1)	114	5000
PDL-35-10		White	0.65 x 0.20 (16.5 x 5.1)	114	10,000
PDL-273		White	0.75 x 0.25 (19.1 x 6.4)	115	5000
PDL-38		White	0.75 x 0.25 (19.1 x 6.4)	115	5000
PDL-38-10		White	0.75 x 0.25 (19.1 x 6.4)	115	10,000
PDL-21-1		White	1.00 x 0.50 (25.4 x 12.7)	117	1000
PDL-21		White	1.00 x 0.50 (25.4 x 12.7)	117	5000
PDL-21-10		White	1.00 x 0.50 (25.4 x 12.7)	117	10,000
PDL-7294-1		White	1.00 x 0.50 (25.4 x 12.7)	117	5000



GMT TEDLAR[▲] - Indoor/Outdoor Applications

Part Number	Material	Color	Label Size Width x Length In. (mm)	Dwg. Page No.	Std. Pkg. Qty.*
PDL-179	GMT TEDLAR [▲]	White	0.25 x 1.44 (6.4 x 36.6)	112	5000
PDL-7966-10		White	0.30 x 0.20 (7.6 x 5.1)	112	10,000
PDL-256		White	0.30 x 0.75 (7.6 x 19.1)	112	5000
PDL-259		White	0.30 x 0.94 (7.6 x 23.8)	112	5000
PDL-183		White	0.38 x 1.44 (9.5 x 36.6)	112	5000
PDL-100		White	0.44 x 2.56 (11.1 x 65.0)	112	5000
PDL-104		White	0.44 x 3.63 (11.1 x 92.1)	113	5000

[▲]TEDLAR is the registered trademark of E. I. DuPont Co

More sizes shown on the following page

Blank Labels by Material (cont.)

Wire Marking

- Can be used as a wrap around label, but is most commonly used as a flag marker on wires and cables
- Used in many OEM and harness house applications with high temperature requirements



Electronic Labeling

- Pliable material is good for curved surfaces
- Use with Panduit Indelible Ink Ribbons found on [pages 126 - 128](#)



Terminal Block Marking

- Strong durable material with permanent adhesive

GMT TEDLAR[▲] - Indoor/Outdoor Applications (cont.)

Part Number	Material	Color	Label Size Width x Length In. (mm)	Dwg. Page No.	Std. Pkg. Qty.*
PDL-120	GMT TEDLAR [▲]	White	0.50 x 0.75 (12.7 x 19.1)	113	5000
PDL-120-10		White	0.50 x 0.75 (12.7 x 19.1)	113	10,000
PDL-44		White	0.50 x 0.75 (12.7 x 19.1)	113	5000
PDL-267		White	0.50 x 0.94 (12.7 x 23.8)	113	5000
PDL-187		White	0.50 x 1.44 (12.7 x 36.5)	113	5000
PDL-137		White	0.50 x 1.44 (12.7 x 36.5) With Horizontal Slit	114	5000
PDL-83		White	0.65 x 0.20 (16.5 x 5.1)	114	5000
PDL-83-10		White	0.65 x 0.20 (16.5 x 5.1)	114	10,000
PDL-84		White	0.75 x 0.25 (19.1 x 6.4)	115	5000
PDL-282		White	0.80 x 0.94 (20.3 x 23.8)	116	5000
PDL-10-1		White	0.80 x 1.44 (20.3 x 36.5)	116	1000
PDL-10		White	0.80 x 1.44 (20.3 x 36.5)	116	5000
PDL-23-1		White	0.90 x 0.25 (22.9 x 6.4)	116	1000
PDL-23		White	0.90 x 0.25 (22.9 x 6.4)	116	5000
PDL-23-10		White	0.90 x 0.25 (22.9 x 6.4)	116	10,000
PDL-284		White	0.90 x 0.25 (22.9 x 6.4)	116	5000
PDL-49		White	0.90 x 0.25 (22.9 x 6.4)	116	5000
PDL-49-10		White	0.90 x 0.25 (22.9 x 6.4)	116	10,000
PDL-4565-1		White	0.98 x 0.59 (25.0 x 15.0)	116	5000
PDL-75		White	1.00 x 0.38 (25.4 x 9.5)	116	5000
PDL-230		Yellow	1.00 x 0.50 (25.4 x 12.7)	117	5000
PDL-99		White	1.00 x 0.50 (25.4 x 12.7)	117	5000
PDL-99-10		White	1.00 x 0.50 (25.4 x 12.7)	117	10,000
PDL-290-1		White	1.00 x 0.75 (25.4 x 19.1)	117	1000
PDL-290		White	1.00 x 0.75 (25.4 x 19.1)	117	5000
PDL-293		White	1.00 x 0.94 (25.4 x 23.8)	117	5000
PDL-296		White	1.00 x 1.44 (25.4 x 36.5) With Horizontal Perforation	117	5000
PDL-4674-3		White	1.13 x 0.53 (28.6 x 13.5)	117	20,000
PDL-4565-2		White	1.18 x 0.37 (30.0 x 9.5)	117	5000
PDL-127		Yellow	1.25 x 0.38 (31.8 x 9.5)	118	5000
PDL-128		White	1.25 x 0.38 (31.8 x 9.5)	118	5000
PDL-128-10		White	1.25 x 0.38 (31.8 x 9.5)	118	10,000
PDL-129		Gray	1.25 x 0.38 (31.8 x 9.5)	118	5000
PDL-24		Yellow	1.25 x 0.38 (31.8 x 9.5)	118	5000
PDL-25		White	1.25 x 0.38 (31.8 x 9.5)	118	5000
PDL-25-10		White	1.25 x 0.38 (31.8 x 9.5)	118	10,000
PDL-26		Silver	1.25 x 0.38 (31.8 x 9.5)	118	5000
PDL-86		White	1.50 x 0.25 (38.1 x 6.4) With Vertical Perforation	118	5000
PDL-27		White	1.50 x 0.75 (38.1 x 19.1)	119	5000
PDL-27-10		White	1.50 x 0.75 (38.1 x 19.1)	119	10,000
PDL-28	Yellow	1.50 x 0.75 (38.1 x 19.1)	119	5000	
PDL-110-1	White	2.00 x 0.38 (50.8 x 9.5)	119	1000	
PDL-110	White	2.00 x 0.38 (50.8 x 9.5)	119	5000	
PDL-76	White	2.00 x 0.38 (50.8 x 9.5)	119	5000	
PDL-7557-1	White	2.50 x 4.25 (63.5 x 108.0)	120	1000	
PDL-79	White	3.00 x 0.38 (76.2 x 9.5)	120	5000	

[▲]TEDLAR is the registered trademark of E. I. DuPont Co

Blank Labels by Material (cont.)

- Durable label material
- Use on colored or clear surfaces
- Use with Panduit Indelible Ink Ribbons found on [pages 126 - 128](#)

GMY-C Polyester - Indoor/Outdoor Applications

Part Number	Material	Color	Label Size Width x Length In. (mm)	Dwg. Page No.	Std. Pkg. Qty.*
PDL-402-D	GMY-C Polyester	Clear	0.56 x 0.19 (14.3 x 4.8)	114	500
PDL-402-10		Clear	0.56 x 0.19 (14.3 x 4.8)	114	10,000
PDL-401-D		Clear	0.56 x 0.56 (14.3 x 14.3)	114	500
PDL-401		Clear	0.56 x 0.56 (14.3 x 14.3)	114	5000
PDL-401-10		Clear	0.56 x 0.56 (14.3 x 14.3)	114	10,000
PDL-363		Clear	1.00 x 0.50 (25.4 x 12.7)	117	5000
PDL-407-1		Clear	1.38 x 0.28 (34.9 x 7.1)	118	1000
PDL110G5		Clear	2.00 x 0.38 (50.8 x 9.5)	119	5000
PDL-404-1		Clear	7.50 x 0.50 (190.5 x 12.7)	121	1000
PDL-404-2.5		Clear	7.50 x 0.50 (190.5 x 12.7)	121	2500



Bar Code Labeling

- Durable label material for permanent bar codes
- Can also be used for inventory, asset and equipment labeling



High Temperature Applications

- Adhesive becomes permanent after 24 hours
- Durable label material for the top of circuit boards
- Material Temperature: 310°F (154°C) - 2nd highest temperature rated Panduit material

GMY-W Polyester - Indoor/Outdoor Applications

Part Number	Material	Color	Label Size Width x Length In. (mm)	Dwg. Page No.	Std. Pkg. Qty.*
PDL-177	GMY-W Polyester	White	0.25 x 1.44 (6.4 x 36.6)	112	5000
PDL-253		White	0.30 x 0.30 (7.6 x 7.6)	112	5000
PDL-253-10		White	0.30 x 0.30 (7.6 x 7.6)	112	10,000
PDL-264		White	0.38 x 0.38 (9.5 x 9.5)	112	5000
PDL-264-10		White	0.38 x 0.38 (9.5 x 9.5)	112	10,000
PDL-181		White	0.38 x 1.44 (9.5 x 36.6)	112	5000
PDL-101		White	0.44 x 2.56 (11.1 x 65.0)	112	5000
PDL-105		White	0.44 x 3.63 (11.1 x 92.1)	113	5000
PDL-47		White	0.50 x 0.44 (12.7 x 11.1)	113	5000
PDL-47-10		White	0.50 x 0.44 (12.7 x 11.1)	113	10,000
PDL-121		White	0.50 x 0.75 (12.7 x 19.1)	113	5000
PDL-90		White	0.50 x 0.75 (12.7 x 19.1)	113	5000
PDL-14		White	0.50 x 1.44 (12.7 x 36.5)	113	5000
PDL-14-10		White	0.50 x 1.44 (12.7 x 36.5)	113	10,000
PDL-185		White	0.50 x 1.44 (12.7 x 36.5)	113	5000
PDL-136		White	0.50 x 1.44 (12.7 x 36.5) With Horizontal Slit	114	5000
PDL-405-D		White	0.56 x 0.19 (14.3 x 4.8)	114	500
PDL-405-10		White	0.56 x 0.19 (14.3 x 4.8)	114	10,000
PDL-406-D		White	0.56 x 0.56 (14.3 x 14.3)	114	500
PDL-406-10		White	0.56 x 0.56 (14.3 x 14.3)	114	10,000
PDL-400		Electrical Ivory	0.56 x 0.56 (14.3 x 14.3)	114	5000
PDL-269		White	0.65 x 0.20 (16.5 x 5.1) With Tamper Resistant Slits	114	5000
PDL-36		White	0.65 x 0.20 (16.5 x 5.1)	114	5000
PDL-36-10		White	0.65 x 0.20 (16.5 x 5.1)	114	10,000
PDL-274		White	0.75 x 0.25 (19.1 x 6.4)	115	5000
PDL-274-10		White	0.75 x 0.25 (19.1 x 6.4)	115	10,000
PDL-39		White	0.75 x 0.25 (19.1 x 6.4)	115	5000
PDL-39-10	White	0.75 x 0.25 (19.1 x 6.4)	115	10,000	
PDL-277	White	0.75 x 0.25 (19.1 x 6.4) With Tamper Resistant Slits	115	5000	
PDL-277-10	White	0.75 x 0.25 (19.1 x 6.4) With Tamper Resistant Slits	115	10,000	

More sizes shown on the following page

Blank Labels by Material (cont.)



Electronic Labeling

- Adhesive becomes permanent after 24 hours
- Durable material ideal for the top of circuit boards
- Can be used before wave solder process
- UV resistant for outdoor applications, field marking applications
- Material Temperature: 310°F (154°C) - 2nd highest temperature rated Panduit material



Harsh Environment Labeling

- Adhesive becomes permanent after 24 hours
- Durable label material, solvent resistant
- UV resistant for outdoor applications

GMY-W Polyester - Indoor/Outdoor Applications (cont.)

Part Number	Material	Color	Label Size Width x Length In. (mm)	Dwg. Page No.	Std. Pkg. Qty.*
PDL-279	GMY-W Polyester	White	0.80 x 0.20 (20.3 x 5.1)	115	5000
PDL-279-10		White	0.80 x 0.20 (20.3 x 5.1)	115	10,000
PDL-172		White	0.80 x 0.50 (20.3 x 12.7)	115	5000
PDL-172-10		White	0.80 x 0.50 (20.3 x 12.7)	115	10,000
PDL-172R		White	0.80 x 0.50 (20.3 x 12.7)•	115	1 Roll (10,000 Labels)
PDL-285		White	0.90 x 0.25 (22.9 x 6.4)	116	5000
PDL-94-1		White	0.90 x 0.25 (22.9 x 6.4)	116	1000
PDL-94		White	0.90 x 0.25 (22.9 x 6.4)	116	5000
PDL-94-10		White	0.90 x 0.25 (22.9 x 6.4)	116	10,000
PDL-287		White	0.90 x 0.25 (22.9 x 6.4) With Tamper Resistant Slits	116	5000
PDL-31		White	1.00 x 0.38 (25.4 x 9.5)	116	5000
PDL-31-10		White	1.00 x 0.38 (25.4 x 9.5)	116	10,000
PDL-157		White	1.00 x 0.50 (25.4 x 12.7)	117	5000
PDL-20-1		White	1.00 x 0.50 (25.4 x 12.7)	117	1000
PDL-20		White	1.00 x 0.50 (25.4 x 12.7)	117	5000
PDL-20-10		White	1.00 x 0.50 (25.4 x 12.7)	117	10,000
PDL-131		White	1.25 x 0.38 (31.8 x 9.5)	118	5000
PDL-5712-2		White with Red Border	1.25 x 0.38 (31.8 x 9.5)	118	25,000
PDL-71		White	1.25 x 0.38 (31.8 x 9.5)	118	5000
PDL-409-1		White	1.38 x 0.28 (34.9 x 7.1)	118	1000
PDL-358		White	1.50 x 0.25 (38.1 x 6.4)	118	5000
PDL-87		White	1.50 x 0.25 (38.1 x 6.4) With Vertical Perforation	118	5000
PDL-87-10		White	1.50 x 0.25 (38.1 x 6.4) With Vertical Perforation	118	10,000
PDL-231		White	1.50 x 0.75 (38.1 x 19.1)	119	5000
PDL-231-10		White	1.50 x 0.75 (38.1 x 19.1)	119	10,000
PDL-111-1		White	2.00 x 0.38 (50.8 x 9.5)	119	1000
PDL-111		White	2.00 x 0.38 (50.8 x 9.5)	119	5000
PDL-77		White	2.00 x 0.38 (50.8 x 9.5)	119	5000
PDL-301		White	2.00 x 0.90 (50.8 x 22.9)	119	1000
PDL-150		White	2.00 x 1.25 (50.8 x 31.8)	119	1000
PDL-305		White	2.00 x 1.44 (50.8 x 36.5)	120	1000
PDL-305-10		White	2.00 x 1.44 (50.8 x 36.5)	120	10,000
PDL-80		White	3.00 x 0.38 (76.2 x 9.5)	120	5000
PDL-311		White	3.00 x 0.90 (76.2 x 22.9)	120	1000
PDL-315		White	3.00 x 1.44 (76.2 x 36.5)	120	1000
PDL-319		White	3.00 x 1.90 (76.2 x 48.3)	120	1000
PDL-144		White	3.00 x 2.00 (76.2 x 50.8)	120	1000
PDL-156		White	3.25 x 1.25 (82.6 x 31.8)	120	1000
PDL-327		White	3.90 x 1.44 (99.1 x 36.5)	121	1000
PDL-403-1†		White	7.50 x 0.50 (190.5 x 12.7)	121	1000
PDL-403-2.5	White	7.50 x 0.50 (190.5 x 12.7)	121	2500	

†Label also available in TIA Specified colors for Network Systems applications. To order, add B for Blue, BR for Brown, G for Green, GR for Gray, OR for Orange, PR for Purple, R for Red, Y for Yellow.
 • Indicates label is roll mounted

Blank Labels by Material (cont.)



- UV opaque material used to cover EPROM windows
- Adhesive becomes permanent after 24 hours
- Durable material for the top of circuit boards
- Can be used before wave solder process
- Use with Panduit Indelible Ink Ribbons found on [pages 126 - 128](#)

GYM-S Polyester - Indoor/Outdoor Applications

Part Number	Material	Color	Label Size Width x Length In. (mm)	Dwg. Page No.	Std. Pkg. Qty.*
PDL-48-1	GYM-S Polyester	Silver	0.50 x 0.44 (12.7 x 11.1)	113	1000
PDL-48		Silver	0.50 x 0.44 (12.7 x 11.1)	113	5000
PDL-48-10		Silver	0.50 x 0.44 (12.7 x 11.1)	113	10,000
PDL-234		Silver	0.65 x 0.20 (16.5 x 5.1)	114	5000
PDL-234-10		Silver	0.65 x 0.20 (16.5 x 5.1)	114	10,000
PDL-236		Silver	0.75 x 0.25 (19.1 x 6.4)	115	5000
PDL-236-10		Silver	0.75 x 0.25 (19.1 x 6.4)	115	10,000
PDL-275		Silver	0.75 x 0.25 (19.1 x 6.4)	115	5000
PDL-175		Silver	0.81 x 0.50 (20.7 x 12.7)	116	5000
PDL-68		Silver	0.90 x 0.25 (22.9 x 6.4)	116	5000
PDL-158		Silver	1.00 x 0.50 (25.4 x 12.7)	117	5000
PDL-22-1		Silver	1.00 x 0.50 (25.4 x 12.7)	117	1000
PDL-22		Silver	1.00 x 0.50 (25.4 x 12.7)	117	5000
PDL-22-10		Silver	1.00 x 0.50 (25.4 x 12.7)	117	10,000
PDL-7542-10		Silver	1.50 x 0.25 (38.1 x 6.4)	118	10,000
PDL-29-1		Silver	1.50 x 0.75 (38.1 x 19.1)	119	1000
PDL-29		Silver	1.50 x 0.75 (38.1 x 19.1)	119	5000
PDL-29-10		Silver	1.50 x 0.75 (38.1 x 19.1)	119	10,000
PDL-7572-1R		Silver	1.63 x 0.38 (41.3 x 9.5)•	119	1000
PDL-7572-10R		Silver	1.63 x 0.38 (41.3 x 9.5)•	119	10,000
PDL-7517		Silver	2.00 x 0.38 (50.8 x 9.5)	119	5000
PDL-302		Silver	2.00 x 0.90 (50.8 x 22.9)	119	1000
PDL-145		Silver	2.00 x 1.25 (50.8 x 31.8)	119	1000
PDL-306		Silver	2.00 x 1.44 (50.8 x 36.5)	120	1000
PDL-312		Silver	3.00 x 0.90 (76.2 x 22.9)	120	1000
PDL-316		Silver	3.00 x 1.44 (76.2 x 36.5)	120	1000
PDL-320		Silver	3.00 x 1.90 (76.2 x 48.3)	120	1000
PDL-139		Silver	3.00 x 2.00 (76.2 x 50.8)	120	1000
PDL-151		Silver	3.25 x 1.25 (82.6 x 31.8)	120	1000
PDL-328		Silver	3.90 x 1.44 (99.1 x 36.5)	121	1000

• Indicates label is roll mounted

TIA/EIA-606 Compliant Network Systems Labeling



What is TIA/EIA-606?

TIA/EIA-606 is a standard from the Telecommunications Industry Association which requires labeling and administration of the telecommunication infrastructure in commercial buildings. TIA-606 applies to Cables, Connectors, Hub Facilities, Termination Facilities (Patch Panels), Conduits and Pathways.

Panduit manufactures a broad range of labeling products to help you conform to TIA/EIA-606.

Along with the labels already shown in this section, the following pages feature labels designed specifically for Network Systems Labeling. Many of these labels can be used with Dot-Matrix and Laser Printers.

*For more information on the complete line of **PAN-NET™** Network Cabling System Products, ask for the Communication Products Catalog.*

Cable Labeling



Color Coded Self-Laminating Labels

- Labels have colored strip on left side to provide 360° color coding
- White Print-On area is highly legible
- Clear overlaminates protects legend
- Available in 2 materials and 8 colors

GMV3 Self-Laminating Vinyl Labels - Indoor Applications

Part Number	Material	Print-On Area Color	Label Size Width x Length In. (mm)	Print-On Area Width x Length In. (mm)	Nominal Cable Outside Diameter * In. (mm)	Dwg. Page No.	Std. Pkg. Qty.*
PDL-1B†	GMV3 Self-Laminating Vinyl	White with Blue Strip on Left	0.50 x 1.44 (12.7 x 36.5)	0.50 x 0.50 (12.7 x 12.7)	0.16 - 0.30 (4.0 - 7.6)	106	5000
PDL-8B†			0.80 x 1.44 (20.3 x 36.5)	0.80 x 0.50 (20.3 x 12.7)	0.16 - 0.30 (4.0 - 7.6)	106	5000
PDL-2B†			1.00 x 1.44 (25.4 x 36.5)	1.00 x 0.50 (25.4 x 12.7)	0.16 - 0.30 (4.0 - 7.6)	108	5000
PDL-4B†			1.00 x 2.44 (25.4 x 61.9)	1.00 x 0.75 (25.4 x 19.1)	0.24 - 0.54 (6.1 - 13.7)	108	1000
PDL-6B†			1.00 x 3.94 (25.4 x 100.1)	1.00 x 1.00 (25.4 x 25.4)	0.32 - 0.94 (8.1 - 23.8)	109	1000
PDL-3B†			2.00 x 1.44 (50.8 x 36.5)	2.00 x 0.50 (50.8 x 12.7)	0.16 - 0.30 (4.0 - 7.6)	110	5000
PDL-5B†			2.00 x 2.44 (50.8 x 61.9)	2.00 x 0.75 (50.8 x 19.1)	0.24 - 0.54 (6.1 - 13.7)	110	1000
PDL-7B††			2.00 x 3.94 (50.8 x 100.1)	2.00 x 1.00 (50.8 x 25.4)	0.32 - 0.94 (8.1 - 23.8)	111	1000

*Refer to Wire Size Selection Guide on page 196 to review diameters of commonly used cables

†Other colors available. To order, replace B with BR for Brown, G for Green, GR for Gray, OR for Orange, PR for Purple, R for Red, Y for Yellow.

††Other colors available. To order, replace B with G for Green, R for Red, Y for Yellow.

GMT1 Self-Laminating TEDLAR ^ Labels - Indoor/Outdoor and High Temperature Applications

Part Number	Material	Print-On Area Color	Label Size Width x Length In. (mm)	Print-On Area Width x Length In. (mm)	Nominal Cable Outside Diameter * In. (mm)	Dwg. Page No.	Std. Pkg. Qty.*
PDL-53B†	GMT1 Self-Laminating TEDLAR ^	White with Blue Strip on Left	0.50 x 1.38 (12.7 x 34.9)	0.50 x 0.50 (12.7 x 12.7)	0.16 - 0.28 (4.0 - 7.1)	106	5000
PDL-60B†			0.80 x 1.44 (20.3 x 36.5)	0.80 x 0.50 (20.3 x 12.7)	0.16 - 0.30 (4.0 - 7.6)	107	5000
PDL-54B†			1.00 x 1.38 (25.4 x 34.9)	1.00 x 0.50 (25.4 x 12.7)	0.16 - 0.28 (4.0 - 7.1)	108	5000
PDL-56B†			1.00 x 2.44 (25.4 x 61.9)	1.00 x 0.75 (25.4 x 19.1)	0.24 - 0.54 (6.1 - 13.7)	108	1000
PDL-58B†			1.00 x 3.87 (25.4 x 98.3)	1.00 x 1.00 (25.4 x 25.4)	0.32 - 0.91 (8.1 - 23.2)	109	1000
PDL-55B†			2.00 x 1.38 (50.8 x 34.9)	2.00 x 0.50 (50.8 x 12.7)	0.16 - 0.28 (4.0 - 7.1)	110	5000
PDL-57B†			2.00 x 2.44 (50.8 x 61.9)	2.00 x 0.75 (50.8 x 19.1)	0.24 - 0.54 (6.1 - 13.7)	110	1000
PDL-59B†			2.00 x 3.87 (50.8 x 98.3)	2.00 x 1.00 (50.8 x 25.4)	0.32 - 0.91 (8.1 - 23.2)	111	1000

*Refer to Wire Size Selection Guide on page 196 to review diameters of commonly used cables

†Other colors available. To order, replace B with BR for Brown, G for Green, GR for Gray, OR for Orange, PR for Purple, R for Red, Y for Yellow.

^TEDLAR is the registered trademark of E. I. DuPont Co.

Network Systems Labels — Termination Hardware



Adhesive Labels

- Eliminate the need for standard paper designation strips
- Labels are placed on top of label holders

Adhesive 110 Punch Down Block Labels

Part Number	Material	Color	Label Width In. (mm)	Label Length In. (mm)	Vertical Repeat In. (mm)	Labels Per Row	Labels Per Roll	Web Width In. (mm)	Std. Pkg. Qty.*
PDL-403-1	GMY-W Polyester	White	7.50 (190.5)	0.50 (12.7)	0.50 (12.7)	1	1000•	8.50 (215.9)	1000
PDL-403-1B		Blue	7.50 (190.5)	0.50 (12.7)	0.50 (12.7)	1	1000•	8.50 (215.9)	1000
PDL-403-1BR		Brown	7.50 (190.5)	0.50 (12.7)	0.50 (12.7)	1	1000•	8.50 (215.9)	1000
PDL-403-1G		Green	7.50 (190.5)	0.50 (12.7)	0.50 (12.7)	1	1000•	8.50 (215.9)	1000
PDL-403-1GR		Gray	7.50 (190.5)	0.50 (12.7)	0.50 (12.7)	1	1000•	8.50 (215.9)	1000
PDL-403-1OR		Orange	7.50 (190.5)	0.50 (12.7)	0.50 (12.7)	1	1000•	8.50 (215.9)	1000
PDL-403-1PR		Purple	7.50 (190.5)	0.50 (12.7)	0.50 (12.7)	1	1000•	8.50 (215.9)	1000
PDL-403-1R		Red	7.50 (190.5)	0.50 (12.7)	0.50 (12.7)	1	1000•	8.50 (215.9)	1000
PDL-403-1Y		Yellow	7.50 (190.5)	0.50 (12.7)	0.50 (12.7)	1	1000•	8.50 (215.9)	1000
PDL-403-2.5		White	7.50 (190.5)	0.50 (12.7)	0.50 (12.7)	1	2500•	8.50 (215.9)	2500
PDL-404-1	GMY-C Polyester	Clear	7.50 (190.5)	0.50 (12.7)	0.50 (12.7)	1	1000•	8.50 (215.9)	1000
PDL-404-2.5		Clear	7.50 (190.5)	0.50 (12.7)	0.50 (12.7)	1	2500•	8.50 (215.9)	2500

•Indicates label is supplied on rolls



Non-Adhesive Labels

- Can be used in Dot-Matrix and Laser Printers

Non-Adhesive 110 Punch Down Block Labels

Part Number	Material	Color	Label Width In. (mm)	Label Length In. (mm)	Vertical Repeat In. (mm)	Labels Per Row	Rows Per Fanfold	Web Width In. (mm)	Std. Pkg. Qty.*
DS110	Semi-Rigid Paper	White	7.95 (200.0)	0.50 (12.7)	0.50 (12.7)	1	15	8.50 (215.9)	150
DS110-BR		Brown	7.95 (200.0)	0.50 (12.7)	0.50 (12.7)	1	15	8.50 (215.9)	150
DS110-BU		Blue	7.95 (200.0)	0.50 (12.7)	0.50 (12.7)	1	15	8.50 (215.9)	150
DS110-GR		Green	7.95 (200.0)	0.50 (12.7)	0.50 (12.7)	1	15	8.50 (215.9)	150
DS110-IG		Gray	7.95 (200.0)	0.50 (12.7)	0.50 (12.7)	1	15	8.50 (215.9)	150
DS110-OR		Orange	7.95 (200.0)	0.50 (12.7)	0.50 (12.7)	1	15	8.50 (215.9)	150
DS110-RD		Red	7.95 (200.0)	0.50 (12.7)	0.50 (12.7)	1	15	8.50 (215.9)	150
DS110-VL		Violet	7.95 (200.0)	0.50 (12.7)	0.50 (12.7)	1	15	8.50 (215.9)	150
DS110-YL		Yellow	7.95 (200.0)	0.50 (12.7)	0.50 (12.7)	1	15	8.50 (215.9)	150

For more information on the complete **PAN-NET™** Network Cabling System Products, ask for the Communication Products Catalog.

Network Systems Labels — Termination Hardware (cont.)



Adhesive Label for Patch Panels and Modular Furniture Faceplates

- Label is perforated on black lines to be used in 2 position, 4 position, or 6 position applications
- For Dot-Matrix and Laser printers

Part Number	Material	Color	Label Width In. (mm)	Label Length In. (mm)	Horiz. Repeat In. (mm)	Vert. Repeat In. (mm)	Labels Per Row	Rows Per Fanfold	Web Width In. (mm)	Std. Pkg. Qty.*
CPPLF-5	GMPO Polyolefin	White	0.61 (15.5)	0.33 (8.4)	0.61 (15.5)	0.33 (8.4)	12	25	8.50 (215.9)	5000
CPPLF-5BU		Blue	0.61 (15.5)	0.33 (8.4)	0.61 (15.5)	0.33 (8.4)	12	25	8.50 (215.9)	5000
CPPLF-5EI		Ivory	0.61 (15.5)	0.33 (8.4)	0.61 (15.5)	0.33 (8.4)	12	25	8.50 (215.9)	5000
CPPLF-5GR		Green	0.61 (15.5)	0.33 (8.4)	0.61 (15.5)	0.33 (8.4)	12	25	8.50 (215.9)	5000
CPPLF-5IG		Gray	0.61 (15.5)	0.33 (8.4)	0.61 (15.5)	0.33 (8.4)	12	25	8.50 (215.9)	5000
CPPLF-5OR		Orange	0.61 (15.5)	0.33 (8.4)	0.61 (15.5)	0.33 (8.4)	12	25	8.50 (215.9)	5000
CPPLF-5PR		Purple	0.61 (15.5)	0.33 (8.4)	0.61 (15.5)	0.33 (8.4)	12	25	8.50 (215.9)	5000
CPPLF-5RD		Red	0.61 (15.5)	0.33 (8.4)	0.61 (15.5)	0.33 (8.4)	12	25	8.50 (215.9)	5000
CPPLF-5YL		Yellow	0.61 (15.5)	0.33 (8.4)	0.61 (15.5)	0.33 (8.4)	12	25	8.50 (215.9)	5000

Network Systems Labels — Termination Position



MINI-JACK™ Modular Jack and OPTI-JACK™ Fiber Optic Connector Labels

- Identify individual jacks and connectors
- Wrap around design allows for quick and secure installation
- Labels attach directly to jacks
- Labels have preprinted black fold lines to speed installation

For Dot-Matrix Printers Only

Part Number	Material	Color	Label Width In. (mm)	Label Length In. (mm)	Horizontal Repeat In. (mm)	Vertical Repeat In. (mm)	Labels Per Row	Rows Per Fanfold	Web Width In. (mm)	Std. Pkg. Qty.*
PDL-411-1	Polyester	Clear	1.38 (34.9)	0.19 (4.8)	1.50 (38.1)	0.50 (12.7)	3	24	5.38 (136.5)	1000
PDL-411-1BU		Blue	1.38 (34.9)	0.19 (4.8)	1.50 (38.1)	0.50 (12.7)	3	24	5.38 (136.5)	1000
PDL-411-1EI		Ivory	1.38 (34.9)	0.19 (4.8)	1.50 (38.1)	0.50 (12.7)	3	24	5.38 (136.5)	1000
PDL-411-1GR		Green	1.38 (34.9)	0.19 (4.8)	1.50 (38.1)	0.50 (12.7)	3	24	5.38 (136.5)	1000
PDL-411-1IG		Gray	1.38 (34.9)	0.19 (4.8)	1.50 (38.1)	0.50 (12.7)	3	24	5.38 (136.5)	1000
PDL-411-1OR		Orange	1.38 (34.9)	0.19 (4.8)	1.50 (38.1)	0.50 (12.7)	3	24	5.38 (136.5)	1000
PDL-411-1VL		Violet	1.38 (34.9)	0.19 (4.8)	1.50 (38.1)	0.50 (12.7)	3	24	5.38 (136.5)	1000
PDL-411-1RD		Red	1.38 (34.9)	0.19 (4.8)	1.50 (38.1)	0.50 (12.7)	3	24	5.38 (136.5)	1000
PDL-411-1YL		Yellow	1.38 (34.9)	0.19 (4.8)	1.50 (38.1)	0.50 (12.7)	3	24	5.38 (136.5)	1000
PDL-412		White	1.38 (34.9)	0.19 (4.8)	1.50 (38.1)	0.50 (12.7)	3	24	5.38 (136.5)	1000

*Order number of labels required in multiples of Std. Pkg. Qty.

Network Systems Labels — Termination Position (cont.)



Faceplates Labels

- For use with **MINI-COM®** Executive and Designer Series Faceplates
- Adhesive label designed to fit on vinyl insert provided with faceplate
- Single and Double Gang versions available
- Can also be used with **MINI-COM** Surface Mount boxes

Part Number	Faceplate Type	Material	Color	Label Width In. (mm)	Label Length In. (mm)	Horizontal Repeat In. (mm)	Vertical Repeat In. (mm)	Labels Per Row	Rows Per Fanfold	Web Width In. (mm)	Std. Pkg. Qty.*
Adhesive Faceplate Labels — For Dot-Matrix Printers Only											
EFPL-1	Single Gang	GMPO Polyolefin	White	1.80 (45.7)	0.38 (9.5)	2.00 (50.8)	0.50 (12.7)	2	22	4.80 (121.9)	1000
EFPL-BU-1			Blue	1.80 (45.7)	0.38 (9.5)	2.00 (50.8)	0.50 (12.7)	2	22	4.80 (121.9)	1000
EFPL-EI-1			Ivory	1.80 (45.7)	0.38 (9.5)	2.00 (50.8)	0.50 (12.7)	2	22	4.80 (121.9)	1000
EFPL-GR-1			Green	1.80 (45.7)	0.38 (9.5)	2.00 (50.8)	0.50 (12.7)	2	22	4.80 (121.9)	1000
EFPL-IG-1			Gray	1.80 (45.7)	0.38 (9.5)	2.00 (50.8)	0.50 (12.7)	2	22	4.80 (121.9)	1000
EFPL-OR-1			Orange	1.80 (45.7)	0.38 (9.5)	2.00 (50.8)	0.50 (12.7)	2	22	4.80 (121.9)	1000
EFPL-RD-1			Red	1.80 (45.7)	0.38 (9.5)	2.00 (50.8)	0.50 (12.7)	2	22	4.80 (121.9)	1000
EFPL-VL-1			Violet	1.80 (45.7)	0.38 (9.5)	2.00 (50.8)	0.50 (12.7)	2	22	4.80 (121.9)	1000
EFPL-YL-1			Yellow	1.80 (45.7)	0.38 (9.5)	2.00 (50.8)	0.50 (12.7)	2	22	4.80 (121.9)	1000
EFPL10-1			Double Gang	GMPO Polyolefin	White	2.90 (73.7)	0.30 (7.6)	—	0.50 (12.7)	1	22
EFPL10-BU-1	Blue	2.90 (73.7)			0.30 (7.6)	—	0.50 (12.7)	1	22	4.68 (118.9)	1000
EFPL10-EI-1	Ivory	2.90 (73.7)			0.30 (7.6)	—	0.50 (12.7)	1	22	4.68 (118.9)	1000
EFPL10-GR-1	Green	2.90 (73.7)			0.30 (7.6)	—	0.50 (12.7)	1	22	4.68 (118.9)	1000
EFPL10-IG-1	Gray	2.90 (73.7)			0.30 (7.6)	—	0.50 (12.7)	1	22	4.68 (118.9)	1000
EFPL10-OR-1	Orange	2.90 (73.7)			0.30 (7.6)	—	0.50 (12.7)	1	22	4.68 (118.9)	1000
EFPL10-RD-1	Red	2.90 (73.7)			0.30 (7.6)	—	0.50 (12.7)	1	22	4.68 (118.9)	1000
EFPL10-VL-1	Violet	2.90 (73.7)			0.30 (7.6)	—	0.50 (12.7)	1	22	4.68 (118.9)	1000
EFPL10-YL-1	Yellow	2.90 (73.7)			0.30 (7.6)	—	0.50 (12.7)	1	22	4.68 (118.9)	1000
Non-Adhesive Faceplate Labels on Sheets — For Dot-Matrix and Laser Printers											
EFPT-1	Single Gang	Semi-Rigid Paper	White	1.80 (45.7)	0.38 (9.5)	1.80 (45.7)	0.38 (9.5)	4	19	8.50 (215.9)	1000
EFPT10-1	Double Gang		White	2.90 (73.7)	0.30 (7.6)	2.90 (73.7)	0.30 (7.6)	2	24	8.50 (215.9)	1000
Non-Adhesive Faceplate Labels on Rolls — For Dot-Matrix Printers Only											
PDL-408-TL	Single Gang	Semi-Rigid Vinyl	White	1.95 (49.5)	0.40 (10.2)	—	0.50 (12.7)	1	250*	2.95 (74.9)	1 Roll (250 Labels)
PDL-410-TL	Double Gang		White	3.00 (76.2)	0.33 (8.5)	—	0.33 (8.5)	1	250*	4.00 (101.6)	1 Roll (250 Labels)

*Indicates label is roll mounted

*For more information on the complete **PAN-NET™** Network Cabling System Products, ask for the Communication Products Catalog.*

Machinery Materials Identification Labels



DIN A4 Sheet Format

Part Number	Color	Material	Print-On Area Width x Length In. (mm)	Labels Per Row	Rows Per Sheet	Labels Per Sheet	Std. Pkg. Qty.*
PECWMS-1065BW	White with a black frame	GMC Vinyl Cloth	2.56 x 0.39 (65.0 x 10.0)	3	26	78	25 Sheets
PECWMS-1119BW			0.75 x 0.43 (19.1 x 11.0)	10	24	240	25 Sheets
PECWMS-1138BW			1.50 x 0.43 (38.0 x 11.0)	5	24	120	25 Sheets
PECWMS-1442BW			1.65 x 0.55 (42.0 x 14.0)	4	19	76	25 Sheets
PECWMS-2256BW			2.20 x 0.87 (56.0 x 22.0)	3	12	36	25 Sheets
PECWMS-820B	Yellow with a black frame		0.79 x 0.31 (20.0 x 8.0)	9	33	297	25 Sheets
PECWMS-915B			0.59 x 0.35 (15.0 x 9.0)	12	29	348	25 Sheets
PECWMS-1119B			0.75 x 0.43 (19.1 x 11.0)	10	24	240	25 Sheets
PECWMS-1138B			1.50 x 0.43 (38.0 x 11.0)	5	24	120	25 Sheets
PECWMS-2256B			2.20 x 0.87 (56.0 x 22.0)	3	12	36	25 Sheets
PECWMS-3560B	Yellow with no frame		2.36 x 1.38 (60.0 x 35.0)	3	8	24	25 Sheets
PECWMS-820			0.79 x 0.31 (20.0 x 8.0)	9	33	297	25 Sheets
PECWMS-915			0.59 x 0.35 (15.0 x 9.0)	12	29	348	25 Sheets
PECWMS-1119			0.75 x 0.43 (19.1 x 11.0)	10	24	240	25 Sheets
PECWMS-1138			1.50 x 0.43 (38.0 x 11.0)	5	24	120	25 Sheets

*Order number of sheets required in multiples of Std. Pkg. Qty.

- GMC Vinyl Cloth with adhesive that can be removed without leaving any adhesive residue
- Available in two formats

DIN A4 Sheet Format

- For Lettering with Panduit Marking Pens (see below), typewriter or dot-matrix printer

Pinfeed Format

- For printing with a dot-matrix printer

Pinfeed Format

Part Number	Color	Material	Print-On Area Width x Length In. (mm)	Labels Per Row	Rows Per Fanfold	Labels Per Fanfold	Std. Pkg. Qty.*
PEDL-820	Yellow with no frame	GMC Vinyl Cloth	0.79 x 0.31 (20.0 x 8.0)	9	24	216	5000
PEDL-915			0.59 x 0.35 (15.0 x 9.0)	12	24	288	5000
PEDL-1119			0.75 x 0.43 (19.1 x 11.0)	9	18	162	5000
PEDL-1138			1.50 x 0.43 (38.0 x 11.0)	5	18	90	5000
PEDL-2256			2.20 x 0.87 (56.0 x 22.0)	3	12	36	1000

*Order number of labels required in multiples of Std. Pkg. Qty.

Marking Pens



- Fast drying permanent ink

Part Number	Color	Description	Std. Pkg. Qty.*
PX-0	Black	Regular Tip Pen Reversible tip to extend life of pen.	12
PX-2	Red		12
PFX-0	Black	Fine Tip Pen For detailed marking	12
PFX-2	Red		12

*Order number of pens required in multiple of Std. Pkg. Qty.

Typewriter Sheets



- Markers are positioned for standard typewriter spacing
- White Print-On Area with clear lamination
- Available in two materials and two sheet formats

8.5" x 8.5" (215.9mm x 215.9mm) Sheet Size

Part Number	Material	Print-On Area Width x Length In. (mm)	Total Marker Size Width x Length In. (mm)	Markers per Sheet	Nominal Cable Outside Diameter [■] In. (mm)	Std. Pkg. Qty.*
PSWMS-0515	GMV3 Self-Laminating Vinyl	0.50 x 0.50 (12.7 x 12.7)	0.50 x 1.50 (12.7 x 38.1)	64	0.16 - 0.32 (4.0 - 8.1)	25 Sheets
PSWMS-1015		1.00 x 0.50 (25.4 x 12.7)	1.00 x 1.50 (25.4 x 38.1)	32		
PSWMS-2015		2.00 x 0.50 (50.8 x 12.7)	2.00 x 1.50 (50.8 x 38.1)	16		
PSWMS-1022		1.00 x 0.75 (25.4 x 19.1)	1.00 x 2.25 (25.4 x 57.1)	24	0.24 - 0.48 (6.1 - 12.1)	
PSWMS-2022		2.00 x 0.75 (50.8 x 19.1)	2.00 x 2.25 (50.8 x 57.1)	12		
PSWMS-1037		1.00 x 1.00 (25.4 x 25.4)	1.00 x 3.75 (25.4 x 95.2)	16	0.32 - 0.87 (8.1 - 22.2)	
PSWMS-2037		2.00 x 1.00 (50.8 x 25.4)	2.00 x 3.75 (50.8 x 95.2)	8		

8.3" x 11.7" (210mm x 297mm) Sheet Size

Part Number	Material	Print-On Area Width x Length In. (mm)	Total Marker Size Width x Length In. (mm)	Markers per Sheet	Nominal Cable Outside Diameter [■] In. (mm)	Std. Pkg. Qty.*
PESWMS-01	GMVF Self-Laminating Vinyl-Free Polyolefin	0.70 x 0.33 (17.8 x 8.5)	0.70 x 1.33 (17.8 x 33.8)	80	0.10 - 0.32 (2.7 - 8.1)	25 Sheets
PESWMS-02		0.90 x 0.50 (22.9 x 12.7)	0.90 x 2.16 (22.9 x 55.0)	40	0.16 - 0.53 (4.0 - 13.4)	
PESWMS-03		1.00 x 0.66 (25.4 x 16.9)	1.00 x 2.66 (25.4 x 67.7)	28	0.21 - 0.64 (5.3 - 16.2)	
PESWMS-04		1.20 x 0.83 (30.5 x 21.2)	1.20 x 2.66 (30.5 x 67.7)	24	0.26 - 0.58 (6.7 - 14.8)	
PESWMS-05		1.40 x 1.00 (35.6 x 25.4)	1.40 x 3.66 (35.6 x 93.1)	15	0.32 - 0.85 (8.1 - 21.5)	
PESWMS-06		1.40 x 1.00 (35.6 x 25.4)	1.40 x 5.50 (35.6 x 139.7)	10	0.32 - 1.43 (8.1 - 36.4)	
PESWMS-07		1.80 x 1.16 (45.7 x 29.6)	1.80 x 5.50 (45.7 x 139.7)	8	0.37 - 1.38 (9.3 - 35.1)	

*Order number of sheets required in multiples of Std. Pkg. Qty.

■ Refer to Wire Size Selection Guide on [page 196](#) to review diameters of commonly used cables

General Use Labels

- Highly ink receptive paper for economical printing applications

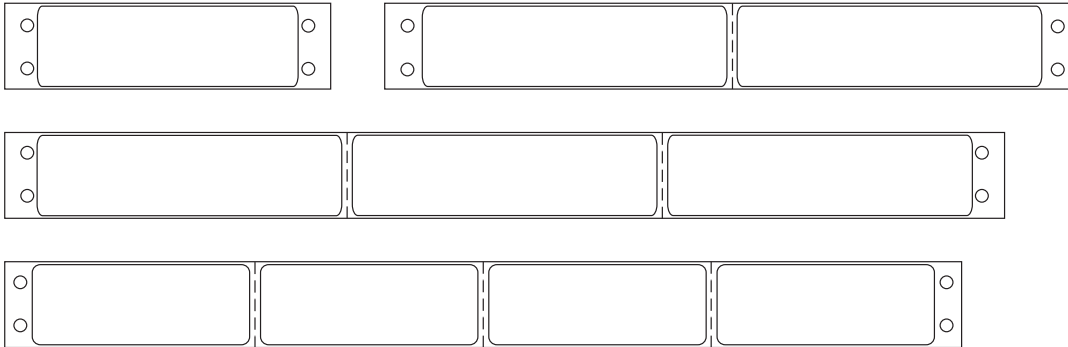

Part Number	Material	Labels Size Width x Length In. (mm)	Labels Per Row	Web Width In. (mm)	Horizontal Sheet Perforations In. (mm)	Vertical Repeat In. (mm)	Std. Pkg. Qty.*	
PL2515-1	Litho Paper	2.50 x 0.94 (63.5 x 23.8)	1	3.50 (88.9)	6.00 (152.4)	1.00 (25.4)	5000	
PL2515-2		2.50 x 0.94 (63.5 x 23.8)	2	6.00 (152.4)	6.00 (152.4)	1.00 (25.4)	10,000	
PL2515-3		2.50 x 0.94 (63.5 x 23.8)	3	8.50 (215.9)	6.00 (152.4)	1.00 (25.4)	15,000	
PL2515-4		2.50 x 0.94 (63.5 x 23.8)	4	11.00 (279.4)	6.00 (152.4)	1.00 (25.4)	20,000	
PL2515-5		2.50 x 0.94 (63.5 x 23.8)	5	14.00 (355.6)	6.00 (152.4)	1.00 (25.4)	2500	
PL2757-1	Litho Paper	2.75 x 0.45 (69.9 x 11.1)	1	3.50 (88.9)	6.00 (152.4)	0.50 (12.7)	10,000	
PL2757-4		2.75 x 0.45 (69.9 x 11.1)	4	12.13 (308.1)	6.00 (152.4)	0.50 (12.7)	40,000	
PL27515-1		2.75 x 0.94 (69.9 x 23.8)	1	3.50 (88.9)	6.00 (152.4)	1.00 (25.4)	5000	
PL27515-3		2.75 x 0.94 (69.9 x 23.8)	3	9.50 (241.3)	6.00 (152.4)	1.00 (25.4)	15,000	
PL27515-4		2.75 x 0.94 (69.9 x 23.8)	4	12.13 (308.1)	6.00 (152.4)	1.00 (25.4)	20,000	
PL27517-1		2.75 x 1.44 (69.9 x 36.5)	1	3.50 (88.9)	6.00 (152.4)	1.50 (38.1)	5000	
PL275115-1		2.75 x 1.94 (69.9 x 49.2)	1	3.50 (88.9)	2.00 (50.8)	2.00 (50.8)	5000	
PL2915-4	Litho Paper	2.90 x 0.94 (73.7 x 23.8)	4	12.75 (323.9)	6.00 (152.4)	1.00 (25.4)	20,000	
PL315-1	Litho Paper	3.00 x 0.94 (76.2 x 23.8)	1	3.75 (95.3)	6.00 (152.4)	1.00 (25.4)	5000	
PL315-4		3.00 x 0.94 (76.2 x 23.8)	4	13.00 (330.2)	6.00 (152.4)	1.00 (25.4)	20,000	
PL3215-4	Litho Paper	3.20 x 0.94 (81.3 x 23.8)	4	13.00 (330.2)	6.00 (152.4)	1.00 (25.4)	20,000	
PL3315-4	Litho Paper	3.30 x 0.94 (83.82 x 23.8)	4	14.25 (362.0)	6.00 (152.4)	1.00 (25.4)	20,000	
PL357-1	Litho Paper	3.50 x 0.45 (88.9 x 11.1)	1	4.25 (108.0)	6.00 (152.4)	0.50 (12.7)	10,000	
PL357-2		3.50 x 0.45 (88.9 x 11.1)	2	8.00 (203.2)	6.00 (152.4)	0.50 (12.7)	20,000	
PL357-3		3.50 x 0.45 (88.9 x 11.1)	3	11.50 (292.1)	6.00 (152.4)	0.50 (12.7)	30,000	
PL3515-1		3.50 x 0.94 (88.9 x 23.8)	1	4.25 (108.0)	6.00 (152.4)	1.00 (25.4)	5000	
PL3515-2		3.50 x 0.94 (88.9 x 23.8)	2	8.00 (203.2)	6.00 (152.4)	1.00 (25.4)	10,000	
PL3515-3		3.50 x 0.94 (88.9 x 23.8)	3	11.50 (292.1)	6.00 (152.4)	1.00 (25.4)	15,000	
PL3515-4		3.50 x 0.94 (88.9 x 23.8)	4	15.25 (387.4)	6.00 (152.4)	1.00 (25.4)	20,000	
PL3517-1		3.50 x 1.44 (88.9 x 36.5)	1	4.25 (108.0)	6.00 (152.4)	1.50 (38.1)	5000	
PL3517-3		3.50 x 1.44 (88.9 x 36.5)	3	11.00 (279.4)	6.00 (152.4)	1.50 (38.1)	15,000	
PL35115-1		3.50 x 1.94 (88.9 x 49.2)	1	4.25 (108.0)	2.00 (50.8)	2.00 (50.8)	5000	
PL35115-3		3.50 x 1.94 (88.9 x 49.2)	3	11.50 (292.1)	2.00 (50.8)	2.00 (50.8)	10,000	
PL47-1		Litho Paper	4.00 x 0.45 (101.6 x 11.1)	1	4.75 (120.7)	6.00 (152.4)	0.50 (12.7)	10,000
PL415-1			4.00 x 0.94 (101.6 x 23.8)	1	4.75 (120.7)	6.00 (152.4)	1.00 (25.4)	5000
PL415-2			4.00 x 0.94 (101.6 x 23.8)	2	9.00 (228.6)	6.00 (152.4)	1.00 (25.4)	10,000
PL415-3			4.00 x 0.94 (101.6 x 23.8)	3	13.00 (330.2)	6.00 (152.4)	1.00 (25.4)	15,000
PL417-1	4.00 x 1.44 (101.6 x 36.5)		1	5.00 (127.0)	6.00 (152.4)	1.50 (38.1)	5000	
PL417-2	4.00 x 1.44 (101.6 x 36.5)		2	9.00 (228.6)	6.00 (152.4)	1.50 (38.1)	10,000	
PL417-3	4.00 x 1.44 (101.6 x 36.5)		3	13.00 (330.2)	6.00 (152.4)	1.50 (38.1)	15,000	
PL4115-1	4.00 x 1.94 (101.6 x 49.2)		1	4.75 (120.7)	2.00 (50.8)	2.00 (50.8)	5000	
PL4115-3	4.00 x 1.94 (101.6 x 49.2)		3	13.00 (330.2)	2.00 (50.8)	2.00 (50.8)	10,000	
PL427-1	4.00 x 2.44 (101.6 x 61.9)		1	4.75 (120.7)	2.50 (63.5)	2.50 (63.5)	5000	
PL4215-1	4.00 x 2.94 (101.6 x 74.6)		1	4.75 (120.7)	3.00 (76.2)	3.00 (76.2)	5000	
PL4215-3	4.00 x 2.94 (101.6 x 74.6)		3	13.00 (330.2)	3.00 (76.2)	3.00 (76.2)	7500	
PL425215-1	Litho Paper		4.25 x 2.94 (101.6 x 74.6)	1	5.00 (127.0)	3.00 (76.2)	3.00 (76.2)	5000
PL57-1	Litho Paper		5.00 x 0.45 (127.0 x 11.1)	1	5.75 (146.1)	2.50 (63.5)	0.50 (12.7)	10,000
PL515-1			5.00 x 0.94 (127.0 x 23.8)	1	5.75 (146.1)	6.00 (152.4)	1.00 (25.4)	5000
PL515-2		5.00 x 0.94 (127.0 x 23.8)	2	11.00 (279.4)	6.00 (152.4)	1.00 (25.4)	10,000	
PL517-1		5.00 x 1.44 (127.0 x 36.5)	1	5.75 (146.1)	6.00 (152.4)	1.50 (38.1)	5000	
PL5115-1		5.00 x 1.94 (127.01 x 49.2)	1	5.75 (146.1)	2.00 (50.8)	2.00 (50.8)	5000	
PL5215-1		5.00 x 2.94 (127.0 x 74.6)	1	5.75 (146.1)	3.00 (76.2)	3.00 (76.2)	5000	
PL5215-2		5.00 x 2.94 (127.0 x 74.6)	2	11.00 (279.4)	3.00 (76.2)	3.00 (76.2)	5000	
PL5315-1		5.00 x 3.94 (127.0 x 100.0)	1	5.75 (146.1)	4.00 (101.6)	4.00 (101.6)	5000	
PL5315-2		5.00 x 3.94 (127.0 x 100.0)	2	11.00 (279.4)	4.00 (101.6)	4.00 (101.6)	5000	
PL575215-1		Litho Paper	5.75 x 2.94 (146.1 x 74.6)	1	6.50 (165.1)	3.00 (76.2)	3.00 (76.2)	5000
PL7757-1	Litho Paper	7.75 x 0.45 (196.9 x 11.1)	1	8.50 (215.9)	6.00 (152.4)	0.50 (12.7)	10,000	
PL77515-1		7.75 x 0.94 (196.9 x 23.8)	1	8.50 (215.9)	6.00 (152.4)	1.00 (25.4)	5000	

*Order number of labels required in multiples of Std. Pkg. Qty.

General Use Labels (cont.)

Cheshire Spaced Labels

- Common spacing used on large printers, usually connected to a mainframe computer
- Ideal for large volume mailings
- Large vertical gap between labels



Part Number	Material	Label Size Width x Length In. (mm)	Labels Per Row	Web Width In. (mm)	Horizontal Sheet Perforations In. (mm)	Vertical Repeat In. (mm)	Std. Pkg. Qty.*
PL329-4	Litho Paper	3.20 x 0.90 (81.3 x 22.9)	4	14.88 (378.0)	12.00 (304.8)	1.00 (25.4)	20,000
PL3278-4		3.20 x 0.90 (81.3 x 22.9)	4	14.88 (378.0)	12.00 (304.8)	1.00 (25.4)	40,000

Tinted Labels



- Choose from five pastel colors
- Used to distinguish groups of literature, boxes, packaging, etc.

Part Number	Color Tint	Material	Label Size Width x Length In. (mm)	Labels Per Row	Web Width In. (mm)	Horizontal Sheet Perforations In. (mm)	Vertical Repeat In. (mm)	Std. Pkg. Qty.*
PL3515-1TB	Blue	Litho Paper	3.50 x 0.94 (88.9 x 23.8)	1	4.25 (108.0)	6.00 (152.4)	1.00 (25.4)	5000
PL3515-1TG	Green		3.50 x 0.94 (88.9 x 23.8)	1	4.25 (108.0)	6.00 (152.4)	1.00 (25.4)	5000
PL3515-1TP	Pink		3.50 x 0.94 (88.9 x 23.8)	1	4.25 (108.0)	6.00 (152.4)	1.00 (25.4)	5000
PL3515-1TT	Tan		3.50 x 0.94 (88.9 x 23.8)	1	4.25 (108.0)	6.00 (152.4)	1.00 (25.4)	5000
PL3515-1TY	Yellow		3.50 x 0.94 (88.9 x 23.8)	1	4.25 (108.0)	6.00 (152.4)	1.00 (25.4)	5000
PL417-1TB	Blue	Litho Paper	4.00 x 0.94 (101.6 x 23.8)	1	4.8 (120.7)	6.00 (152.4)	1.00 (25.4)	5000
PL417-1TG	Green		4.00 x 0.94 (101.6 x 23.8)	1	4.8 (120.7)	6.00 (152.4)	1.00 (25.4)	5000
PL417-1TP	Pink		4.00 x 0.94 (101.6 x 23.8)	1	4.8 (120.7)	6.00 (152.4)	1.00 (25.4)	5000
PL417-1TT	Tan		4.00 x 0.94 (101.6 x 23.8)	1	4.8 (120.7)	6.00 (152.4)	1.00 (25.4)	5000
PL417-1TY	Yellow		4.00 x 0.94 (101.6 x 23.8)	1	4.8 (120.7)	6.00 (152.4)	1.00 (25.4)	5000

File Folder



- Allows identifying and sorting of files by color
- Permanent adhesive

Part Number	Color Tint	Material	Label Size Width x Length In. (mm)	Labels Per Row	Web Width In. (mm)	Horizontal Sheet Perforations In. (mm)	Vertical Repeat In. (mm)	Std. Pkg. Qty.*
PL3510-1F	White	Litho Paper	3.50 x 0.64 (88.9 x 16.13)	1	4.25 (108.0)	6.00 (152.4)	1.00 (25.4)	5000
PL3510-1FB	Blue		3.50 x 0.64 (88.9 x 16.13)	1	4.25 (108.0)	6.00 (152.4)	1.00 (25.4)	5000
PL3510-1FBR	Brown		3.50 x 0.64 (88.9 x 16.13)	1	4.25 (108.0)	6.00 (152.4)	1.00 (25.4)	5000
PL3510-1FG	Green		3.50 x 0.64 (88.9 x 16.13)	1	4.25 (108.0)	6.00 (152.4)	1.00 (25.4)	5000
PL3510-1FO	Orange		3.50 x 0.64 (88.9 x 16.13)	1	4.25 (108.0)	6.00 (152.4)	1.00 (25.4)	5000
PL3510-1FP	Pink		3.50 x 0.64 (88.9 x 16.13)	1	4.25 (108.0)	6.00 (152.4)	1.00 (25.4)	5000
PL3510-1FPU	Purple		3.50 x 0.64 (88.9 x 16.13)	1	4.25 (108.0)	6.00 (152.4)	1.00 (25.4)	5000
PL3510-1FR	Red		3.50 x 0.64 (88.9 x 16.13)	1	4.25 (108.0)	6.00 (152.4)	1.00 (25.4)	5000
PL3510-1FY	Yellow		3.50 x 0.64 (88.9 x 16.13)	1	4.25 (108.0)	6.00 (152.4)	1.00 (25.4)	5000

General Use Labels (cont.)

Pricing Labels



- Economical labels that can be used in high volume applications. Ideal for labeling electronic components or anywhere labeling of smaller items is required
- Permanent adhesive

Part Number	Material	Label Size Width x Length In. (mm)	Labels Per Row	Web Width In. (mm)	Horizontal Sheet Perforations In. (mm)	Vertical Repeat In. (mm)	Std. Pkg. Qty.*
PL115-12	Litho Paper	1.00 x 0.94 (25.4 x 23.8)	12 (Joined by perforations)	13.00 (330.2)	1.00 (25.4)	1.00 (25.4)	48,000

Removable Labels



- Common size mailing with a removable adhesive
- Ideal for any application where removal of label is a factor

Part Number	Material	Label Size Width x Length In. (mm)	Labels Per Row	Web Width In. (mm)	Horizontal Sheet Perforations In. (mm)	Vertical Repeat In. (mm)	Std. Pkg. Qty.*
PL3515-1R	Removable Litho Paper	3.50 x 0.94 (88.9 x 23.8)	1	4.25 (108.0)	6.00 (152.4)	1.00 (25.4)	5000
PL3515-3R		3.50 x 0.94 (88.9 x 23.8)	3	11.50 (292.1)	6.00 (152.4)	1.00 (25.4)	15,000
PL417-1R		4.00 x 0.94 (101.6 x 23.8)	1	4.8 (120.7)	6.00 (152.4)	1.00 (25.4)	5000

Tape Reel Labels



- Designed for film or video reels
- Smudge-proof surface and a removable adhesive allows reel to be reused and re-labeled

Part Number	Material	Style	Label Size Width x Length In. (mm)	Labels Per Row	Web Width In. (mm)	Horizontal Sheet Perforations In. (mm)	Vertical Repeat In. (mm)	Std. Pkg. Qty.*
PL3515-1TRL	Litho Paper	K	3.50 x 0.94 (88.9 x 23.8)	1	4.25 (108.0)	1.00 (25.4)	1.00 (25.4)	5000
PL3517-1TRL		K	3.50 x 1.44 (88.9 x 36.5)	1	4.25 (108.0)	1.50 (38.1)	1.50 (38.1)	5000
PL417-1TRL		K	4.00 x 1.44 (101.6 x 36.5)	1	4.8 (120.7)	1.50 (38.1)	1.50 (38.1)	5000
PL3817-1TRL		L	3.88 x 1.44 (98.4 x 36.5)	1	4.8 (120.7)	1.50 (38.1)	1.50 (38.1)	5000
PL38175-1TRL		M	3.88 x 1.75 (98.4 x 44.5)	1	4.8 (120.7)	2.00 (50.8)	2.00 (50.8)	5000
PL4175-1TRL		N	4.00 x 1.75 (101.6 x 44.5)	1	4.8 (120.7)	2.00 (50.8)	2.00 (50.8)	5000

Automotive Labels



PL130315-2P Has pre-printed legend

- Sizes used to meet automotive shipping bar code requirements

Part Number	Material	Label Size Width x Length In. (mm)	Labels Per Row	Web Width In. (mm)	Horizontal Sheet Perforations In. (mm)	Vertical Repeat In. (mm)	Std. Pkg. Qty.*
PL130315-2	Litho Paper	13.00 x 3.94 (304.8 x 100.0)	Set of 2	14.00 (355.6)	4.00 (101.6)	4.00 (101.6)	2500
PL130315-2P■		13.00 x 3.94 (304.8 x 100.0)	Set of 2	14.00 (355.6)	4.00 (101.6)	4.00 (101.6)	2500
PL6315-1		6.00 x 3.98 (152.4 x 100.0)	1	6.75 (171.5)	4.00 (101.6)	4.00 (101.6)	2500
PL6315-2		6.00 x 3.98 (152.4 x 100.0)	2	13.00 (330.2)	14.00 (355.6)	4.00 (101.6)	5000
PL65315-2		6.00 x 3.98 (152.4 x 100.0)	2	14.00 (355.6)	4.00 (101.6)	4.00 (101.6)	5000

■ Indicates pre-printed legend

PDL Self-Laminating Labels by Size

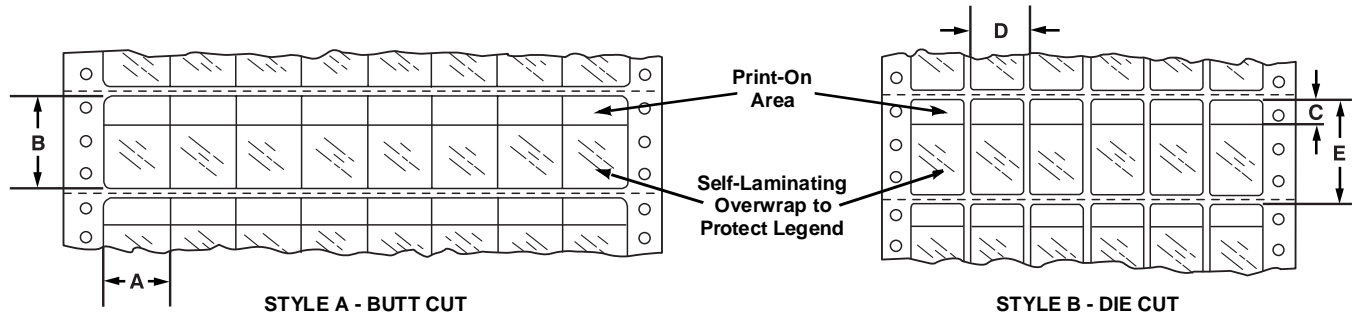

Part Number	Style	Material	Print-On Area Color	Label Width A In. (mm)	Label Length B In. (mm)	Print-On Length C In. (mm)	Horizontal Repeat D In. (mm)	Vertical Repeat E In. (mm)	Labels Per Row	Rows Per Fanfold	Web Width F In. (mm)	Std. Pkg. Qty.*
PDL-238	A	SL TEDLAR [†]	White	0.30 (7.6)	0.75 (19.1)	0.38 (9.5)	0.30 (7.6)	1.00 (25.4)	16	12	5.80 (147.3)	5000
PDL-239	A	SL Vinyl	White	0.30 (7.6)	0.75 (19.1)	0.38 (9.5)	0.30 (7.6)	1.00 (25.4)	16	12	5.80 (147.3)	5000
PDL-239VF	A	Vinyl Free SL	White	0.30 (7.6)	0.75 (19.1)	0.38 (9.5)	0.30 (7.6)	1.00 (25.4)	16	12	5.80 (147.3)	5000
PDL-240	A	SL TEDLAR	White	0.30 (7.6)	0.94 (23.8)	0.38 (9.5)	0.30 (7.6)	1.00 (25.4)	16	12	5.80 (147.3)	5000
PDL-241	A	SL Vinyl	White	0.30 (7.6)	0.94 (23.8)	0.38 (9.5)	0.30 (7.6)	1.00 (25.4)	16	12	5.80 (147.3)	5000
PDL-168	A	SL Vinyl	White	0.36 (9.14)	0.94 (23.8)	0.38 (9.5)	0.36 (9.14)	1.00 (25.4)	22	12	7.94 (201.68)	5000
PDL-169	A	SL TEDLAR	White	0.36 (9.14)	0.94 (23.8)	0.38 (9.5)	0.36 (9.14)	1.00 (25.4)	22	12	7.94 (201.68)	5000
PDL-42	B	SL Vinyl	White	0.50 (12.7)	0.75 (19.1)	0.38 (9.5)	0.60 (15.2)	1.00 (25.4)	14	12	9.30 (236.2)‡	5000
PDL-42-10	B	SL Vinyl	White	0.50 (12.7)	0.75 (19.1)	0.38 (9.5)	0.60 (15.2)	1.00 (25.4)	14	12	9.30 (236.2)‡	10,000
PDL-88	B	SL TEDLAR	White	0.50 (12.7)	0.75 (19.1)	0.38 (9.5)	0.60 (15.2)	1.00 (25.4)	14	12	9.30 (236.2)‡	5000
PDL-117	B	SL Vinyl	White	0.50 (12.7)	0.75 (19.1)	0.38 (9.5)	0.60 (15.2)	1.00 (25.4)	12	12	8.10 (205.7)	5000
PDL-118-1	B	SL TEDLAR	White	0.50 (12.7)	0.75 (19.1)	0.38 (9.5)	0.60 (15.2)	1.00 (25.4)	12	12	8.10 (205.7)	1000
PDL-118	B	SL TEDLAR	White	0.50 (12.7)	0.75 (19.1)	0.38 (9.5)	0.60 (15.2)	1.00 (25.4)	12	12	8.10 (205.7)	5000
PDL-118-10	B	SL TEDLAR	White	0.50 (12.7)	0.75 (19.1)	0.38 (9.5)	0.60 (15.2)	1.00 (25.4)	12	12	8.10 (205.7)	10,000
PDL-242	A	SL TEDLAR	White	0.50 (12.7)	0.94 (23.8)	0.38 (9.5)	0.50 (12.7)	1.00 (25.4)	16	12	9.00 (228.6)	5000
PDL-243	A	SL Vinyl	White	0.50 (12.7)	0.94 (23.8)	0.38 (9.5)	0.50 (12.7)	1.00 (25.4)	16	12	9.00 (228.6)	5000
PDL-53	A	SL TEDLAR	White	0.50 (12.7)	1.38 (34.9)	0.50 (12.7)	0.50 (12.7)	1.50 (38.1)	16	8	9.00 (228.6)	5000
PDL-53B	A	SL TEDLAR	Blue/White	0.50 (12.7)	1.38 (34.9)	0.50 (12.7)	0.50 (12.7)	1.50 (38.1)	16	8	9.00 (228.6)	5000
PDL-53BR	A	SL TEDLAR	Brown/White	0.50 (12.7)	1.38 (34.9)	0.50 (12.7)	0.50 (12.7)	1.50 (38.1)	16	8	9.00 (228.6)	5000
PDL-53G	A	SL TEDLAR	Green/White	0.50 (12.7)	1.38 (34.9)	0.50 (12.7)	0.50 (12.7)	1.50 (38.1)	16	8	9.00 (228.6)	5000
PDL-53GR	A	SL TEDLAR	Gray/White	0.50 (12.7)	1.38 (34.9)	0.50 (12.7)	0.50 (12.7)	1.50 (38.1)	16	8	9.00 (228.6)	5000
PDL-53OR	A	SL TEDLAR	Orange/White	0.50 (12.7)	1.38 (34.9)	0.50 (12.7)	0.50 (12.7)	1.50 (38.1)	16	8	9.00 (228.6)	5000
PDL-53PR	A	SL TEDLAR	Purple/White	0.50 (12.7)	1.38 (34.9)	0.50 (12.7)	0.50 (12.7)	1.50 (38.1)	16	8	9.00 (228.6)	5000
PDL-53R	A	SL TEDLAR	Red/White	0.50 (12.7)	1.38 (34.9)	0.50 (12.7)	0.50 (12.7)	1.50 (38.1)	16	8	9.00 (228.6)	5000
PDL-53Y	A	SL TEDLAR	Yellow/White	0.50 (12.7)	1.38 (34.9)	0.50 (12.7)	0.50 (12.7)	1.50 (38.1)	16	8	9.00 (228.6)	5000
PDL-53-10	A	SL TEDLAR	White	0.50 (12.7)	1.38 (34.9)	0.50 (12.7)	0.50 (12.7)	1.50 (38.1)	16	8	9.00 (228.6)	10,000
PDL-1-1	A	SL Vinyl	White	0.50 (12.7)	1.44 (36.5)	0.50 (12.7)	0.50 (12.7)	1.50 (38.1)	16	8	9.00 (228.6)	1000
PDL-1	A	SL Vinyl	White	0.50 (12.7)	1.44 (36.5)	0.50 (12.7)	0.50 (12.7)	1.50 (38.1)	16	8	9.00 (228.6)	5000
PDL-1B	A	SL Vinyl	Blue/White	0.50 (12.7)	1.44 (36.5)	0.50 (12.7)	0.50 (12.7)	1.50 (38.1)	16	8	9.00 (228.6)	5000
PDL-1BR	A	SL Vinyl	Brown/White	0.50 (12.7)	1.44 (36.5)	0.50 (12.7)	0.50 (12.7)	1.50 (38.1)	16	8	9.00 (228.6)	5000
PDL-1G	A	SL Vinyl	Green/White	0.50 (12.7)	1.44 (36.5)	0.50 (12.7)	0.50 (12.7)	1.50 (38.1)	16	8	9.00 (228.6)	5000
PDL-1GR	A	SL Vinyl	Gray/White	0.50 (12.7)	1.44 (36.5)	0.50 (12.7)	0.50 (12.7)	1.50 (38.1)	16	8	9.00 (228.6)	5000
PDL-1OR	A	SL Vinyl	Orange/White	0.50 (12.7)	1.44 (36.5)	0.50 (12.7)	0.50 (12.7)	1.50 (38.1)	16	8	9.00 (228.6)	5000
PDL-1PR	A	SL Vinyl	Purple/White	0.50 (12.7)	1.44 (36.5)	0.50 (12.7)	0.50 (12.7)	1.50 (38.1)	16	8	9.00 (228.6)	5000
PDL-1R	A	SL Vinyl	Red/White	0.50 (12.7)	1.44 (36.5)	0.50 (12.7)	0.50 (12.7)	1.50 (38.1)	16	8	9.00 (228.6)	5000
PDL-1VF	A	Vinyl Free SL	White	0.50 (12.7)	1.44 (36.5)	0.50 (12.7)	0.50 (12.7)	1.50 (38.1)	16	8	9.00 (228.6)	5000
PDL-1Y	A	SL Vinyl	Yellow/White	0.50 (12.7)	1.44 (36.5)	0.50 (12.7)	0.50 (12.7)	1.50 (38.1)	16	8	9.00 (228.6)	5000
PDL-1-10	A	SL Vinyl	White	0.50 (12.7)	1.44 (36.5)	0.50 (12.7)	0.50 (12.7)	1.50 (38.1)	16	8	9.00 (228.6)	10,000
PDL-12	B	SL Vinyl	White	0.50 (12.7)	1.44 (36.5)	0.50 (12.7)	0.60 (15.2)	1.50 (38.1)	12	8	8.10 (205.7)	5000
PDL-61	B	SL TEDLAR	White	0.50 (12.7)	1.44 (36.5)	0.50 (12.7)	0.60 (15.2)	1.50 (38.1)	12	8	8.10 (205.7)	5000
PDL-6556-2	B	SL Vinyl	White	0.60 (15.2)	1.44 (36.5)	0.50 (12.7)	0.70 (17.8)	1.50 (38.1)	12	8	9.30 (236.2)‡	5000

[†]TEDLAR is the registered trademark of E. I. DuPont Co.
[‡]Wide carriage printer required to print this label
 *Order number of labels required in multiples of Std. Pkg. Qty.

PDL Self-Laminating Labels by Size (cont.)



Part Number	Style	Material	Print-On Area Color	Label Width A In. (mm)	Label Length B In. (mm)	Print-On Length C In. (mm)	Horizontal Repeat D In. (mm)	Vertical Repeat E In. (mm)	Labels Per Row	Rows Per Fanfold	Web Width F In. (mm)	Std. Pkg. Qty.*
PDL-244	B	SL TEDLAR ^	White	0.75 (19.1)	1.75 (44.5)	0.50 (12.7)	0.90 (22.9)	2.00 (50.8)	9	6	9.00 (228.6)	5000
PDL-245-1	B	SL Vinyl	White	0.75 (19.1)	1.75 (44.5)	0.50 (12.7)	0.90 (22.9)	2.00 (50.8)	9	6	9.00 (228.6)	1000
PDL-245	B	SL Vinyl	White	0.75 (19.1)	1.75 (44.5)	0.50 (12.7)	0.90 (22.9)	2.00 (50.8)	9	6	9.00 (228.6)	5000
PDL-245-10	B	SL Vinyl	White	0.75 (19.1)	1.75 (44.5)	0.50 (12.7)	0.90 (22.9)	2.00 (50.8)	9	6	9.00 (228.6)	10,000
PDL-246	A	SL TEDLAR	White	0.80 (20.3)	0.94 (23.8)	0.38 (9.5)	0.80 (20.3)	1.00 (25.4)	10	12	9.00 (228.6)	5000
PDL-247	A	SL Vinyl	White	0.80 (20.3)	0.94 (23.8)	0.38 (9.5)	0.80 (20.3)	1.00 (25.4)	10	12	9.00 (228.6)	5000
PDL-8-1	B	SL Vinyl	White	0.80 (20.3)	1.44 (36.5)	0.50 (12.7)	0.90 (22.9)	1.50 (38.1)	6	8	6.30 (160.0)	1000
PDL-8	B	SL Vinyl	White	0.80 (20.3)	1.44 (36.5)	0.50 (12.7)	0.90 (22.9)	1.50 (38.1)	6	8	6.30 (160.0)	5000
PDL-8B	B	SL Vinyl	Blue/White	0.80 (20.3)	1.44 (36.5)	0.50 (12.7)	0.90 (22.9)	1.50 (38.1)	6	8	6.30 (160.0)	5000
PDL-8BR	B	SL Vinyl	Brown/White	0.80 (20.3)	1.44 (36.5)	0.50 (12.7)	0.90 (22.9)	1.50 (38.1)	6	8	6.30 (160.0)	5000
PDL-8G	B	SL Vinyl	Green/White	0.80 (20.3)	1.44 (36.5)	0.50 (12.7)	0.90 (22.9)	1.50 (38.1)	6	8	6.30 (160.0)	5000
PDL-8GR	B	SL Vinyl	Gray/White	0.80 (20.3)	1.44 (36.5)	0.50 (12.7)	0.90 (22.9)	1.50 (38.1)	6	8	6.30 (160.0)	5000
PDL-8OR	B	SL Vinyl	Orange/White	0.80 (20.3)	1.44 (36.5)	0.50 (12.7)	0.90 (22.9)	1.50 (38.1)	6	8	6.30 (160.0)	5000
PDL-8PR	B	SL Vinyl	Purple/White	0.80 (20.3)	1.44 (36.5)	0.50 (12.7)	0.90 (22.9)	1.50 (38.1)	6	8	6.30 (160.0)	5000
PDL-8R	B	SL Vinyl	Red/White	0.80 (20.3)	1.44 (36.5)	0.50 (12.7)	0.90 (22.9)	1.50 (38.1)	6	8	6.30 (160.0)	5000
PDL-8VF	B	Vinyl Free SL	White	0.80 (20.3)	1.44 (36.5)	0.50 (12.7)	0.90 (22.9)	1.50 (38.1)	6	8	6.30 (160.0)	5000
PDL-8Y	B	SL Vinyl	Yellow/White	0.80 (20.3)	1.44 (36.5)	0.50 (12.7)	0.90 (22.9)	1.50 (38.1)	6	8	6.30 (160.0)	5000
PDL-8-10	B	SL Vinyl	White	0.80 (20.3)	1.44 (36.5)	0.50 (12.7)	0.90 (22.9)	1.50 (38.1)	6	8	6.30 (160.0)	10,000
PDL-60	B	SL TEDLAR	White	0.80 (20.3)	1.44 (36.5)	0.50 (12.7)	0.90 (22.9)	1.50 (38.1)	6	8	6.30 (160.0)	5000
PDL-60B	B	SL TEDLAR	Blue/White	0.80 (20.3)	1.44 (36.5)	0.50 (12.7)	0.90 (22.9)	1.50 (38.1)	6	8	6.30 (160.0)	5000
PDL-60BR	B	SL TEDLAR	Brown/White	0.80 (20.3)	1.44 (36.5)	0.50 (12.7)	0.90 (22.9)	1.50 (38.1)	6	8	6.30 (160.0)	5000
PDL-60G	B	SL TEDLAR	Green/White	0.80 (20.3)	1.44 (36.5)	0.50 (12.7)	0.90 (22.9)	1.50 (38.1)	6	8	6.30 (160.0)	5000
PDL-60GR	B	SL TEDLAR	Gray/White	0.80 (20.3)	1.44 (36.5)	0.50 (12.7)	0.90 (22.9)	1.50 (38.1)	6	8	6.30 (160.0)	5000
PDL-60OR	B	SL TEDLAR	Orange/White	0.80 (20.3)	1.44 (36.5)	0.50 (12.7)	0.90 (22.9)	1.50 (38.1)	6	8	6.30 (160.0)	5000
PDL-60PR	B	SL TEDLAR	Purple/White	0.80 (20.3)	1.44 (36.5)	0.50 (12.7)	0.90 (22.9)	1.50 (38.1)	6	8	6.30 (160.0)	5000
PDL-60R	B	SL TEDLAR	Red/White	0.80 (20.3)	1.44 (36.5)	0.50 (12.7)	0.90 (22.9)	1.50 (38.1)	6	8	6.30 (160.0)	5000
PDL-60Y	B	SL TEDLAR	Yellow/White	0.80 (20.3)	1.44 (36.5)	0.50 (12.7)	0.90 (22.9)	1.50 (38.1)	6	8	6.30 (160.0)	5000
PDL-5859-2	A	SL Vinyl	White	0.82 (20.8)	2.00 (50.8)	0.63 (15.9)	0.82 (20.8)	2.13 (54.0)	11	4	10.50 (266.7)‡	5000
PDL-5859-4	A	SL Vinyl	Yellow	0.82 (20.8)	2.00 (50.8)	0.63 (15.9)	0.82 (20.8)	2.13 (54.0)	11	4	10.50 (266.7)‡	5000
PDL-248	A	SL TEDLAR	White	1.00 (25.4)	0.75 (19.1)	0.38 (9.5)	1.00 (25.4)	1.00 (25.4)	8	12	9.00 (228.6)	5000
PDL-249-1	A	SL Vinyl	White	1.00 (25.4)	0.75 (19.1)	0.38 (9.5)	1.00 (25.4)	1.00 (25.4)	8	12	9.00 (228.6)	1000
PDL-249	A	SL Vinyl	White	1.00 (25.4)	0.75 (19.1)	0.38 (9.5)	1.00 (25.4)	1.00 (25.4)	8	12	9.00 (228.6)	5000
PDL-249VF	A	Vinyl Free SL	White	1.00 (25.4)	0.75 (19.1)	0.38 (9.5)	1.00 (25.4)	1.00 (25.4)	8	12	9.00 (228.6)	5000
PDL-249-10	A	SL Vinyl	White	1.00 (25.4)	0.75 (19.1)	0.38 (9.5)	1.00 (25.4)	1.00 (25.4)	8	12	9.00 (228.6)	10,000
PDL-250	A	SL TEDLAR	White	1.00 (25.4)	0.94 (23.8)	0.38 (9.5)	1.00 (25.4)	1.00 (25.4)	8	12	9.00 (228.6)	5000
PDL-251	A	SL Vinyl	White	1.00 (25.4)	0.94 (23.8)	0.38 (9.5)	1.00 (25.4)	1.00 (25.4)	8	12	9.00 (228.6)	5000

^TEDLAR is the registered trademark of E. I. DuPont Co.
 ‡Wide carriage printer required to print this label
 *Order number of labels required in multiples of Std. Pkg. Qty.

PDL Self-Laminating Labels by Size (cont.)

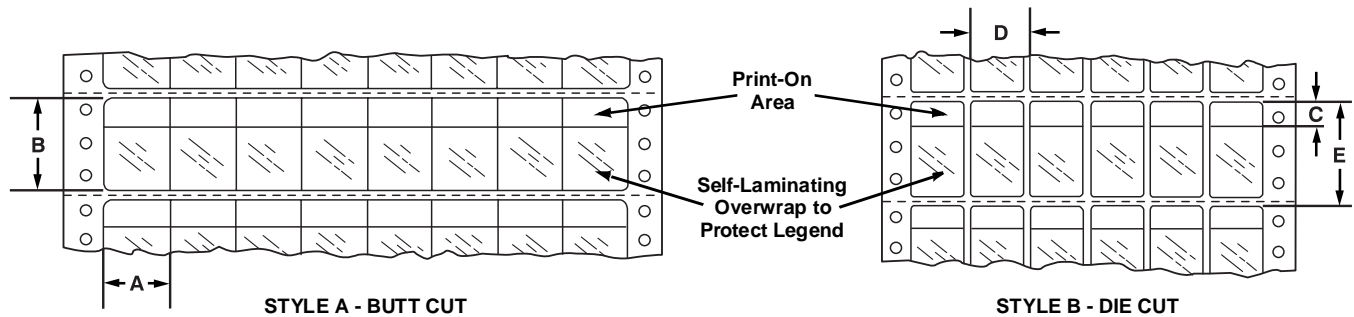

Part Number	Style	Material	Print-On Area Color	Label Width A In. (mm)	Label Length B In. (mm)	Print-On Length C In. (mm)	Horizontal Repeat D In. (mm)	Vertical Repeat E In. (mm)	Labels Per Row	Rows Per Fanfold	Web Width F In. (mm)	Std. Pkg. Qty.*
PDL-54	A	SL TEDLAR ▲	White	1.00 (25.4)	1.38 (34.9)	0.50 (12.7)	1.00 (25.4)	1.50 (38.1)	8	8	9.00 (228.6)	5000
PDL-54B	A	SL TEDLAR	Blue/White	1.00 (25.4)	1.38 (34.9)	0.50 (12.7)	1.00 (25.4)	1.50 (38.1)	8	8	9.00 (228.6)	5000
PDL-54BR	A	SL TEDLAR	Brown/White	1.00 (25.4)	1.38 (34.9)	0.50 (12.7)	1.00 (25.4)	1.50 (38.1)	8	8	9.00 (228.6)	5000
PDL-54G	A	SL TEDLAR	Green/White	1.00 (25.4)	1.38 (34.9)	0.50 (12.7)	1.00 (25.4)	1.50 (38.1)	8	8	9.00 (228.6)	5000
PDL-54GR	A	SL TEDLAR	Gray/White	1.00 (25.4)	1.38 (34.9)	0.50 (12.7)	1.00 (25.4)	1.50 (38.1)	8	8	9.00 (228.6)	5000
PDL-54OR	A	SL TEDLAR	Orange/White	1.00 (25.4)	1.38 (34.9)	0.50 (12.7)	1.00 (25.4)	1.50 (38.1)	8	8	9.00 (228.6)	5000
PDL-54PR	A	SL TEDLAR	Purple/White	1.00 (25.4)	1.38 (34.9)	0.50 (12.7)	1.00 (25.4)	1.50 (38.1)	8	8	9.00 (228.6)	5000
PDL-54R	A	SL TEDLAR	Red/White	1.00 (25.4)	1.38 (34.9)	0.50 (12.7)	1.00 (25.4)	1.50 (38.1)	8	8	9.00 (228.6)	5000
PDL-54Y	A	SL TEDLAR	Yellow/White	1.00 (25.4)	1.38 (34.9)	0.50 (12.7)	1.00 (25.4)	1.50 (38.1)	8	8	9.00 (228.6)	5000
PDL-2-1	A	SL Vinyl	White	1.00 (25.4)	1.44 (36.5)	0.50 (12.7)	1.00 (25.4)	1.50 (38.1)	8	8	9.00 (228.6)	1000
PDL-2	A	SL Vinyl	White	1.00 (25.4)	1.44 (36.5)	0.50 (12.7)	1.00 (25.4)	1.50 (38.1)	8	8	9.00 (228.6)	5000
PDL-2B	A	SL Vinyl	Blue/White	1.00 (25.4)	1.44 (36.5)	0.50 (12.7)	1.00 (25.4)	1.50 (38.1)	8	8	9.00 (228.6)	5000
PDL-2BR	A	SL Vinyl	Brown/White	1.00 (25.4)	1.44 (36.5)	0.50 (12.7)	1.00 (25.4)	1.50 (38.1)	8	8	9.00 (228.6)	5000
PDL-2G	A	SL Vinyl	Green/White	1.00 (25.4)	1.44 (36.5)	0.50 (12.7)	1.00 (25.4)	1.50 (38.1)	8	8	9.00 (228.6)	5000
PDL-2GR	A	SL Vinyl	Gray/White	1.00 (25.4)	1.44 (36.5)	0.50 (12.7)	1.00 (25.4)	1.50 (38.1)	8	8	9.00 (228.6)	5000
PDL-2OR	A	SL Vinyl	Orange/White	1.00 (25.4)	1.44 (36.5)	0.50 (12.7)	1.00 (25.4)	1.50 (38.1)	8	8	9.00 (228.6)	5000
PDL-2PR	A	SL Vinyl	Purple/White	1.00 (25.4)	1.44 (36.5)	0.50 (12.7)	1.00 (25.4)	1.50 (38.1)	8	8	9.00 (228.6)	5000
PDL-2R	A	SL Vinyl	Red/White	1.00 (25.4)	1.44 (36.5)	0.50 (12.7)	1.00 (25.4)	1.50 (38.1)	8	8	9.00 (228.6)	5000
PDL-2VF	A	Vinyl Free SL	White	1.00 (25.4)	1.44 (36.5)	0.50 (12.7)	1.00 (25.4)	1.50 (38.1)	8	8	9.00 (228.6)	5000
PDL-2Y	A	SL Vinyl	Yellow/White	1.00 (25.4)	1.44 (36.5)	0.50 (12.7)	1.00 (25.4)	1.50 (38.1)	8	8	9.00 (228.6)	5000
PDL-2-10	A	SL Vinyl	White	1.00 (25.4)	1.44 (36.5)	0.50 (12.7)	1.00 (25.4)	1.50 (38.1)	8	8	9.00 (228.6)	10,000
PDL-9025-10	A	SL Vinyl	White	1.00 (25.4)	1.44 (36.5)	0.62 (15.8)	1.00 (25.4)	1.50 (38.1)	8	8	9.00 (228.6)	10,000
PDL-4	A	SL Vinyl	White	1.00 (25.4)	2.44 (61.9)	0.75 (19.1)	1.00 (25.4)	2.50 (63.5)	8	4	9.00 (228.6)	1000
PDL-4B	A	SL Vinyl	Blue/White	1.00 (25.4)	2.44 (61.9)	0.75 (19.1)	1.00 (25.4)	2.50 (63.5)	8	4	9.00 (228.6)	1000
PDL-4BR	A	SL Vinyl	Brown/White	1.00 (25.4)	2.44 (61.9)	0.75 (19.1)	1.00 (25.4)	2.50 (63.5)	8	4	9.00 (228.6)	1000
PDL-4G	A	SL Vinyl	Green/White	1.00 (25.4)	2.44 (61.9)	0.75 (19.1)	1.00 (25.4)	2.50 (63.5)	8	4	9.00 (228.6)	1000
PDL-4GR	A	SL Vinyl	Gray/White	1.00 (25.4)	2.44 (61.9)	0.75 (19.1)	1.00 (25.4)	2.50 (63.5)	8	4	9.00 (228.6)	1000
PDL-4OR	A	SL Vinyl	Orange/White	1.00 (25.4)	2.44 (61.9)	0.75 (19.1)	1.00 (25.4)	2.50 (63.5)	8	4	9.00 (228.6)	1000
PDL-4PR	A	SL Vinyl	Purple/White	1.00 (25.4)	2.44 (61.9)	0.75 (19.1)	1.00 (25.4)	2.50 (63.5)	8	4	9.00 (228.6)	1000
PDL-4R	A	SL Vinyl	Red/White	1.00 (25.4)	2.44 (61.9)	0.75 (19.1)	1.00 (25.4)	2.50 (63.5)	8	4	9.00 (228.6)	1000
PDL-4VF	A	Vinyl Free SL	White	1.00 (25.4)	2.44 (61.9)	0.75 (19.1)	1.00 (25.4)	2.50 (63.5)	8	4	9.00 (228.6)	1000
PDL-4Y	A	SL Vinyl	Yellow/White	1.00 (25.4)	2.44 (61.9)	0.75 (19.1)	1.00 (25.4)	2.50 (63.5)	8	4	9.00 (228.6)	1000
PDL-4-10	A	SL Vinyl	White	1.00 (25.4)	2.44 (61.9)	0.75 (19.1)	1.00 (25.4)	2.50 (63.5)	8	4	9.00 (228.6)	10,000
PDL-56	A	SL TEDLAR	White	1.00 (25.4)	2.44 (61.9)	0.75 (19.1)	1.00 (25.4)	2.50 (63.5)	8	4	9.00 (228.6)	1000
PDL-56B	A	SL TEDLAR	Blue/White	1.00 (25.4)	2.44 (61.9)	0.75 (19.1)	1.00 (25.4)	2.50 (63.5)	8	4	9.00 (228.6)	1000
PDL-56BR	A	SL TEDLAR	Brown/White	1.00 (25.4)	2.44 (61.9)	0.75 (19.1)	1.00 (25.4)	2.50 (63.5)	8	4	9.00 (228.6)	1000
PDL-56G	A	SL TEDLAR	Green/White	1.00 (25.4)	2.44 (61.9)	0.75 (19.1)	1.00 (25.4)	2.50 (63.5)	8	4	9.00 (228.6)	1000
PDL-56GR	A	SL TEDLAR	Gray/White	1.00 (25.4)	2.44 (61.9)	0.75 (19.1)	1.00 (25.4)	2.50 (63.5)	8	4	9.00 (228.6)	1000
PDL-56OR	A	SL TEDLAR	Orange/White	1.00 (25.4)	2.44 (61.9)	0.75 (19.1)	1.00 (25.4)	2.50 (63.5)	8	4	9.00 (228.6)	1000
PDL-56PR	A	SL TEDLAR	Purple/White	1.00 (25.4)	2.44 (61.9)	0.75 (19.1)	1.00 (25.4)	2.50 (63.5)	8	4	9.00 (228.6)	1000
PDL-56R	A	SL TEDLAR	Red/White	1.00 (25.4)	2.44 (61.9)	0.75 (19.1)	1.00 (25.4)	2.50 (63.5)	8	4	9.00 (228.6)	1000
PDL-56Y	A	SL TEDLAR	Yellow/White	1.00 (25.4)	2.44 (61.9)	0.75 (19.1)	1.00 (25.4)	2.50 (63.5)	8	4	9.00 (228.6)	1000

▲TEDLAR is the registered trademark of E. I. DuPont Co.
*Order number of labels required in multiples of Std. Pkg. Qty.

PDL Self-Laminating Labels by Size (cont.)



Part Number	Style	Material	Print-On Area Color	Label Width A In. (mm)	Label Length B In. (mm)	Print-On Length C In. (mm)	Horizontal Repeat D In. (mm)	Vertical Repeat E In. (mm)	Labels Per Row	Rows Per Fanfold	Web Width F In. (mm)	Std. Pkg. Qty.*
PDL-58	A	SL TEDLAR ▲	White	1.00 (25.4)	3.87 (98.3)	1.00 (25.4)	1.00 (25.4)	4.00 (101.6)	8	3	9.00 (228.6)	1000
PDL-58B	A	SL TEDLAR	Blue/White	1.00 (25.4)	3.87 (98.3)	1.00 (25.4)	1.00 (25.4)	4.00 (101.6)	8	3	9.00 (228.6)	1000
PDL-58BR	A	SL TEDLAR	Brown/White	1.00 (25.4)	3.87 (98.3)	1.00 (25.4)	1.00 (25.4)	4.00 (101.6)	8	3	9.00 (228.6)	1000
PDL-58G	A	SL TEDLAR	Green/White	1.00 (25.4)	3.87 (98.3)	1.00 (25.4)	1.00 (25.4)	4.00 (101.6)	8	3	9.00 (228.6)	1000
PDL-58GR	A	SL TEDLAR	Gray/White	1.00 (25.4)	3.87 (98.3)	1.00 (25.4)	1.00 (25.4)	4.00 (101.6)	8	3	9.00 (228.6)	1000
PDL-58OR	A	SL TEDLAR	Orange/White	1.00 (25.4)	3.87 (98.3)	1.00 (25.4)	1.00 (25.4)	4.00 (101.6)	8	3	9.00 (228.6)	1000
PDL-58PR	A	SL TEDLAR	Purple/White	1.00 (25.4)	3.87 (98.3)	1.00 (25.4)	1.00 (25.4)	4.00 (101.6)	8	3	9.00 (228.6)	1000
PDL-58R	A	SL TEDLAR	Red/White	1.00 (25.4)	3.87 (98.3)	1.00 (25.4)	1.00 (25.4)	4.00 (101.6)	8	3	9.00 (228.6)	1000
PDL-58Y	A	SL TEDLAR	Yellow/White	1.00 (25.4)	3.87 (98.3)	1.00 (25.4)	1.00 (25.4)	4.00 (101.6)	8	3	9.00 (228.6)	1000
PDL-6	A	SL Vinyl	White	1.00 (25.4)	3.94 (100.1)	1.00 (25.4)	1.00 (25.4)	4.00 (101.6)	8	3	9.00 (228.6)	1000
PDL-6B	A	SL Vinyl	Blue/White	1.00 (25.4)	3.94 (100.1)	1.00 (25.4)	1.00 (25.4)	4.00 (101.6)	8	3	9.00 (228.6)	1000
PDL-6BR	A	SL Vinyl	Brown/White	1.00 (25.4)	3.94 (100.1)	1.00 (25.4)	1.00 (25.4)	4.00 (101.6)	8	3	9.00 (228.6)	1000
PDL-6G	A	SL Vinyl	Green/White	1.00 (25.4)	3.94 (100.1)	1.00 (25.4)	1.00 (25.4)	4.00 (101.6)	8	3	9.00 (228.6)	1000
PDL-6GR	A	SL Vinyl	Gray/White	1.00 (25.4)	3.94 (100.1)	1.00 (25.4)	1.00 (25.4)	4.00 (101.6)	8	3	9.00 (228.6)	1000
PDL-6OR	A	SL Vinyl	Orange/White	1.00 (25.4)	3.94 (100.1)	1.00 (25.4)	1.00 (25.4)	4.00 (101.6)	8	3	9.00 (228.6)	1000
PDL-6PR	A	SL Vinyl	Purple/White	1.00 (25.4)	3.94 (100.1)	1.00 (25.4)	1.00 (25.4)	4.00 (101.6)	8	3	9.00 (228.6)	1000
PDL-6R	A	SL Vinyl	Red/White	1.00 (25.4)	3.94 (100.1)	1.00 (25.4)	1.00 (25.4)	4.00 (101.6)	8	3	9.00 (228.6)	1000
PDL-6VF	A	Vinyl Free SL	White	1.00 (25.4)	3.94 (100.1)	1.00 (25.4)	1.00 (25.4)	4.00 (101.6)	8	3	9.00 (228.6)	1000
PDL-6Y	A	SL Vinyl	Yellow/White	1.00 (25.4)	3.94 (100.1)	1.00 (25.4)	1.00 (25.4)	4.00 (101.6)	8	3	9.00 (228.6)	1000
PDL-6-2.5	A	SL Vinyl	White	1.00 (25.4)	3.94 (100.1)	1.00 (25.4)	1.00 (25.4)	4.00 (101.6)	8	3	9.00 (228.6)	2500
PDL-6-10	A	SL Vinyl	White	1.00 (25.4)	3.94 (100.1)	1.00 (25.4)	1.00 (25.4)	4.00 (101.6)	8	3	9.00 (228.6)	10,000
PDL-51	B	SL Vinyl	White	1.00 (25.4)	5.94 (150.9)	1.50 (38.1)	1.10 (27.9)	6.00 (152.4)	8	2	9.50 (241.3)‡	1000
PDL-95	B	SL TEDLAR	White	1.00 (25.4)	5.94 (150.9)	1.50 (38.1)	1.10 (27.9)	6.00 (152.4)	8	2	9.50 (241.3)‡	1000
PDL-123	B	SL TEDLAR	White	1.00 (25.4)	5.94 (150.9)	1.50 (38.1)	1.10 (27.9)	6.00 (152.4)	7	2	9.00 (228.6)	1000
PDL-124	B	SL Vinyl	White	1.00 (25.4)	5.94 (150.9)	1.50 (38.1)	1.10 (27.9)	6.00 (152.4)	7	2	9.00 (228.6)	1000
PDL-124-2.5	B	SL Vinyl	White	1.00 (25.4)	5.94 (150.9)	1.50 (38.1)	1.10 (27.9)	6.00 (152.4)	7	2	9.00 (228.6)	2500
PDL-124-10	B	SL Vinyl	White	1.00 (25.4)	5.94 (150.9)	1.50 (38.1)	1.10 (27.9)	6.00 (152.4)	7	2	9.00 (228.6)	10,000
PDL-52	B	SL Vinyl	White	1.00 (25.4)	7.44 (189.0)	1.50 (38.1)	1.10 (27.9)	7.50 (190.5)	8	1	9.00 (228.6)	1000
PDL-52-2.5	B	SL Vinyl	White	1.00 (25.4)	7.44 (189.0)	1.50 (38.1)	1.10 (27.9)	7.50 (190.5)	8	1	9.00 (228.6)	2500
PDL-96	B	SL TEDLAR	White	1.00 (25.4)	7.44 (189.0)	1.50 (38.1)	1.10 (27.9)	7.50 (190.5)	8	1	9.50 (241.3)‡	1000
PDL-125	B	SL TEDLAR	White	1.00 (25.4)	7.44 (189.0)	1.50 (38.1)	1.10 (27.9)	7.50 (190.5)	7	2	9.00 (228.6)	1000
PDL-126	B	SL Vinyl	White	1.00 (25.4)	7.44 (189.0)	1.50 (38.1)	1.10 (27.9)	7.50 (190.5)	7	2	9.00 (228.6)	1000
PDL-126-10	B	SL Vinyl	White	1.00 (25.4)	7.44 (189.0)	1.50 (38.1)	1.10 (27.9)	7.50 (190.5)	7	2	9.00 (228.6)	10,000
PDL-5859-1	A	SL Vinyl	White	1.13 (28.6)	3.75 (95.3)	1.25 (31.8)	1.13 (28.6)	4.00 (101.6)	8	3	10.50 (266.7)‡	5000
PDL-5859-3	A	SL Vinyl	Yellow	1.13 (28.6)	3.75 (95.3)	1.25 (31.8)	1.13 (28.6)	4.00 (101.6)	8	3	10.50 (266.7)‡	5000
CCS-WHT	A	SL Vinyl	White	1.17 (29.6)	3.00 (76.4)	0.83 (21.1)	1.17 (29.6)	3.33 (84.6)	6	3	9.50 (241.3)‡	5000
CCS-YEL	A	SL Vinyl	Yellow	1.17 (29.6)	3.00 (76.4)	0.83 (21.1)	1.17 (29.6)	3.33 (84.6)	6	3	9.50 (241.3)‡	5000
PDL-6626-10	B	SL Vinyl	White	1.20 (30.5)	2.25 (57.2)	0.60 (15.2)	1.30 (33.0)	2.50 (63.5)	6	4	8.82 (224.0)	10,000
PDL-3523-1	B	SL Vinyl	White	1.50 (38.1)	2.25 (57.2)	0.50 (12.7)	1.60 (40.6)	2.50 (63.5)	5	4	9.50 (241.3)‡	1000
PDL-361-1	B	SL Vinyl	White	1.50 (38.1)	3.63 (92.1)	0.80 (20.3)	1.60 (40.6)	4.00 (101.6)	5	3	9.00 (228.6)	1000

▲TEDLAR is the registered trademark of E. I. DuPont Co.
 ‡Wide carriage printer required to print this label
 *Order number of labels required in multiples of Std. Pkg. Qty.

PDL Self-Laminating Labels by Size (cont.)

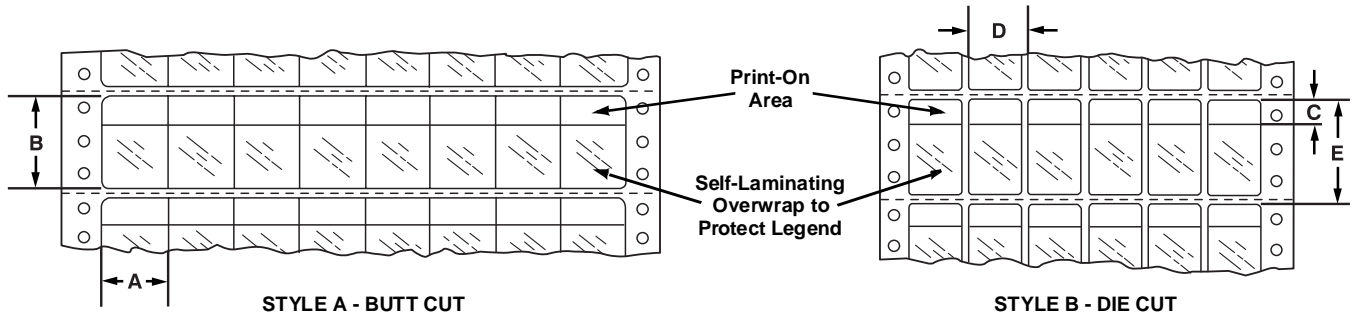

Part Number	Style	Material	Print-On Area Color	Label Width A In. (mm)	Label Length B In. (mm)	Print-On Length C In. (mm)	Horizontal Repeat D In. (mm)	Vertical Repeat E In. (mm)	Labels Per Row	Rows Per Fanfold	Web Width F In. (mm)	Std. Pkg. Qty.*
PDL-18	B	SL Vinyl	White	1.90 (48.3)	3.19 (81.0)	0.75 (19.1)	2.00 (50.8)	3.50 (88.9)	4	3	9.50 (241.3)‡	1000
PDL-18-2.5	B	SL Vinyl	White	1.90 (48.3)	3.19 (81.0)	0.75 (19.1)	2.00 (50.8)	3.50 (88.9)	4	3	9.50 (241.3)‡	2500
PDL-18-10	B	SL Vinyl	White	1.90 (48.3)	3.19 (81.0)	0.75 (19.1)	2.00 (50.8)	3.50 (88.9)	4	3	9.50 (241.3)‡	10,000
PDL-64	B	SL TEDLAR ▲	White	1.90 (48.3)	3.19 (81.0)	0.75 (19.1)	2.00 (50.8)	3.50 (88.9)	4	3	9.50 (241.3)‡	1000
PDL-108	B	SL TEDLAR	White	1.90 (48.3)	3.19 (81.0)	0.75 (19.1)	2.00 (50.8)	3.50 (88.9)	3	3	7.50 (190.5)	1000
PDL-109	B	SL Vinyl	White	1.90 (48.3)	3.19 (81.0)	0.75 (19.1)	2.00 (50.8)	3.50 (88.9)	3	3	7.50 (190.5)	1000
PDL-109-2.5	B	SL Vinyl	White	1.90 (48.3)	3.19 (81.0)	0.75 (19.1)	2.00 (50.8)	3.50 (88.9)	3	3	7.50 (190.5)	2500
PDL-55	A	SL TEDLAR	White	2.00 (50.8)	1.38 (34.9)	0.50 (12.7)	2.00 (50.8)	1.50 (38.1)	4	8	9.00 (228.6)	5000
PDL-55B	A	SL TEDLAR	Blue/White	2.00 (50.8)	1.38 (34.9)	0.50 (12.7)	2.00 (50.8)	1.50 (38.1)	4	8	9.00 (228.6)	5000
PDL-55BR	A	SL TEDLAR	Brown/White	2.00 (50.8)	1.38 (34.9)	0.50 (12.7)	2.00 (50.8)	1.50 (38.1)	4	8	9.00 (228.6)	5000
PDL-55G	A	SL TEDLAR	Green/White	2.00 (50.8)	1.38 (34.9)	0.50 (12.7)	2.00 (50.8)	1.50 (38.1)	4	8	9.00 (228.6)	5000
PDL-55GR	A	SL TEDLAR	Gray/White	2.00 (50.8)	1.38 (34.9)	0.50 (12.7)	2.00 (50.8)	1.50 (38.1)	4	8	9.00 (228.6)	5000
PDL-55OR	A	SL TEDLAR	Orange/White	2.00 (50.8)	1.38 (34.9)	0.50 (12.7)	2.00 (50.8)	1.50 (38.1)	4	8	9.00 (228.6)	5000
PDL-55PR	A	SL TEDLAR	Purple/White	2.00 (50.8)	1.38 (34.9)	0.50 (12.7)	2.00 (50.8)	1.50 (38.1)	4	8	9.00 (228.6)	5000
PDL-55R	A	SL TEDLAR	Red/White	2.00 (50.8)	1.38 (34.9)	0.50 (12.7)	2.00 (50.8)	1.50 (38.1)	4	8	9.00 (228.6)	5000
PDL-55Y	A	SL TEDLAR	Yellow/White	2.00 (50.8)	1.38 (34.9)	0.50 (12.7)	2.00 (50.8)	1.50 (38.1)	4	8	9.00 (228.6)	5000
PDL-3-1	A	SL Vinyl	White	2.00 (50.8)	1.44 (36.5)	0.50 (12.7)	2.00 (50.8)	1.50 (38.1)	4	8	9.00 (228.6)	1000
PDL-3	A	SL Vinyl	White	2.00 (50.8)	1.44 (36.5)	0.50 (12.7)	2.00 (50.8)	1.50 (38.1)	4	8	9.00 (228.6)	5000
PDL-3B	A	SL Vinyl	Blue/White	2.00 (50.8)	1.44 (36.5)	0.50 (12.7)	2.00 (50.8)	1.50 (38.1)	4	8	9.00 (228.6)	5000
PDL-3BR	A	SL Vinyl	Brown/White	2.00 (50.8)	1.44 (36.5)	0.50 (12.7)	2.00 (50.8)	1.50 (38.1)	4	8	9.00 (228.6)	5000
PDL-3G	A	SL Vinyl	Green/White	2.00 (50.8)	1.44 (36.5)	0.50 (12.7)	2.00 (50.8)	1.50 (38.1)	4	8	9.00 (228.6)	5000
PDL-3GR	A	SL Vinyl	Gray/White	2.00 (50.8)	1.44 (36.5)	0.50 (12.7)	2.00 (50.8)	1.50 (38.1)	4	8	9.00 (228.6)	5000
PDL-3OR	A	SL Vinyl	Orange/White	2.00 (50.8)	1.44 (36.5)	0.50 (12.7)	2.00 (50.8)	1.50 (38.1)	4	8	9.00 (228.6)	5000
PDL-3PR	A	SL Vinyl	Purple/White	2.00 (50.8)	1.44 (36.5)	0.50 (12.7)	2.00 (50.8)	1.50 (38.1)	4	8	9.00 (228.6)	5000
PDL-3R	A	SL Vinyl	Red/White	2.00 (50.8)	1.44 (36.5)	0.50 (12.7)	2.00 (50.8)	1.50 (38.1)	4	8	9.00 (228.6)	5000
PDL-3VF	A	Vinyl Free SL	White	2.00 (50.8)	1.44 (36.5)	0.50 (12.7)	2.00 (50.8)	1.50 (38.1)	4	8	9.00 (228.6)	5000
PDL-3Y	A	SL Vinyl	Yellow/White	2.00 (50.8)	1.44 (36.5)	0.50 (12.7)	2.00 (50.8)	1.50 (38.1)	4	8	9.00 (228.6)	5000
PDL-3-10	A	SL Vinyl	White	2.00 (50.8)	1.44 (36.5)	0.50 (12.7)	2.00 (50.8)	1.50 (38.1)	4	8	9.00 (228.6)	10,000
PDL-5	A	SL Vinyl	White	2.00 (50.8)	2.44 (61.9)	0.75 (19.1)	2.00 (50.8)	2.50 (63.5)	4	4	9.00 (228.6)	1000
PDL-5B	A	SL Vinyl	Blue/White	2.00 (50.8)	2.44 (61.9)	0.75 (19.1)	2.00 (50.8)	2.50 (63.5)	4	4	9.00 (228.6)	1000
PDL-5BR	A	SL Vinyl	Brown/White	2.00 (50.8)	2.44 (61.9)	0.75 (19.1)	2.00 (50.8)	2.50 (63.5)	4	4	9.00 (228.6)	1000
PDL-5G	A	SL Vinyl	Green/White	2.00 (50.8)	2.44 (61.9)	0.75 (19.1)	2.00 (50.8)	2.50 (63.5)	4	4	9.00 (228.6)	1000
PDL-5GR	A	SL Vinyl	Gray/White	2.00 (50.8)	2.44 (61.9)	0.75 (19.1)	2.00 (50.8)	2.50 (63.5)	4	4	9.00 (228.6)	1000
PDL-5OR	A	SL Vinyl	Orange/White	2.00 (50.8)	2.44 (61.9)	0.75 (19.1)	2.00 (50.8)	2.50 (63.5)	4	4	9.00 (228.6)	1000
PDL-5PR	A	SL Vinyl	Purple/White	2.00 (50.8)	2.44 (61.9)	0.75 (19.1)	2.00 (50.8)	2.50 (63.5)	4	4	9.00 (228.6)	1000
PDL-5R	A	SL Vinyl	Red/White	2.00 (50.8)	2.44 (61.9)	0.75 (19.1)	2.00 (50.8)	2.50 (63.5)	4	4	9.00 (228.6)	1000
PDL-5Y	A	SL Vinyl	Yellow/White	2.00 (50.8)	2.44 (61.9)	0.75 (19.1)	2.00 (50.8)	2.50 (63.5)	4	4	9.00 (228.6)	1000
PDL-5-2.5	A	SL Vinyl	White	2.00 (50.8)	2.44 (61.9)	0.75 (19.1)	2.00 (50.8)	2.50 (63.5)	4	4	9.00 (228.6)	2500
PDL-5-10	A	SL Vinyl	White	2.00 (50.8)	2.44 (61.9)	0.75 (19.1)	2.00 (50.8)	2.50 (63.5)	4	4	9.00 (228.6)	10,000
PDL-5VF-10	A	Vinyl Free SL	White	2.00 (50.8)	2.44 (61.9)	0.75 (19.1)	2.00 (50.8)	2.50 (63.5)	4	4	9.00 (228.6)	10,000
PDL-57	A	SL TEDLAR	White	2.00 (50.8)	2.44 (61.9)	0.75 (19.1)	2.00 (50.8)	2.50 (63.5)	4	4	9.00 (228.6)	1000
PDL-57B	A	SL TEDLAR	Blue/White	2.00 (50.8)	2.44 (61.9)	0.75 (19.1)	2.00 (50.8)	2.50 (63.5)	4	4	9.00 (228.6)	1000
PDL-57BR	A	SL TEDLAR	Brown/White	2.00 (50.8)	2.44 (61.9)	0.75 (19.1)	2.00 (50.8)	2.50 (63.5)	4	4	9.00 (228.6)	1000

▲TEDLAR is the registered trademark of E. I. DuPont Co.
 ‡Wide carriage printer required to print this label
 *Order number of labels required in multiples of Std. Pkg. Qty.

PDL Self-Laminating Labels by Size (cont.)



Part Number	Style	Material	Print-On Area Color	Label Width A In. (mm)	Label Length B In. (mm)	Print-On Length C In. (mm)	Horizontal Repeat D In. (mm)	Vertical Repeat E In. (mm)	Labels Per Row	Rows Per Fanfold	Web Width F In. (mm)	Std. Pkg. Qty.*
PDL-57G	A	SL TEDLAR ▲	Green/White	2.00 (50.8)	2.44 (61.9)	0.75 (19.1)	2.00 (50.8)	2.50 (63.5)	4	4	9.00 (228.6)	1000
PDL-57GR	A	SL TEDLAR	Gray/White	2.00 (50.8)	2.44 (61.9)	0.75 (19.1)	2.00 (50.8)	2.50 (63.5)	4	4	9.00 (228.6)	1000
PDL-57OR	A	SL TEDLAR	Orange/White	2.00 (50.8)	2.44 (61.9)	0.75 (19.1)	2.00 (50.8)	2.50 (63.5)	4	4	9.00 (228.6)	1000
PDL-57PR	A	SL TEDLAR	Purple/White	2.00 (50.8)	2.44 (61.9)	0.75 (19.1)	2.00 (50.8)	2.50 (63.5)	4	4	9.00 (228.6)	1000
PDL-57R	A	SL TEDLAR	Red/White	2.00 (50.8)	2.44 (61.9)	0.75 (19.1)	2.00 (50.8)	2.50 (63.5)	4	4	9.00 (228.6)	1000
PDL-57Y	A	SL TEDLAR	Yellow/White	2.00 (50.8)	2.44 (61.9)	0.75 (19.1)	2.00 (50.8)	2.50 (63.5)	4	4	9.00 (228.6)	1000
PDL-59	A	SL TEDLAR	White	2.00 (50.8)	3.87 (98.3)	1.00 (25.4)	2.00 (50.8)	4.00 (101.6)	4	3	9.00 (228.6)	1000
PDL-59B	A	SL TEDLAR	Blue/White	2.00 (50.8)	3.87 (98.3)	1.00 (25.4)	2.00 (50.8)	4.00 (101.6)	4	3	9.00 (228.6)	1000
PDL-59BR	A	SL TEDLAR	Brown/White	2.00 (50.8)	3.87 (98.3)	1.00 (25.4)	2.00 (50.8)	4.00 (101.6)	4	3	9.00 (228.6)	1000
PDL-59G	A	SL TEDLAR	Green/White	2.00 (50.8)	3.87 (98.3)	1.00 (25.4)	2.00 (50.8)	4.00 (101.6)	4	3	9.00 (228.6)	1000
PDL-59GR	A	SL TEDLAR	Gray/White	2.00 (50.8)	3.87 (98.3)	1.00 (25.4)	2.00 (50.8)	4.00 (101.6)	4	3	9.00 (228.6)	1000
PDL-59OR	A	SL TEDLAR	Orange/White	2.00 (50.8)	3.87 (98.3)	1.00 (25.4)	2.00 (50.8)	4.00 (101.6)	4	3	9.00 (228.6)	1000
PDL-59PR	A	SL TEDLAR	Purple/White	2.00 (50.8)	3.87 (98.3)	1.00 (25.4)	2.00 (50.8)	4.00 (101.6)	4	3	9.00 (228.6)	1000
PDL-59R	A	SL TEDLAR	Red/White	2.00 (50.8)	3.87 (98.3)	1.00 (25.4)	2.00 (50.8)	4.00 (101.6)	4	3	9.00 (228.6)	1000
PDL-59Y	A	SL TEDLAR	Yellow/White	2.00 (50.8)	3.87 (98.3)	1.00 (25.4)	2.00 (50.8)	4.00 (101.6)	4	3	9.00 (228.6)	1000
PDL-59-10	A	SL TEDLAR	White	2.00 (50.8)	3.87 (98.3)	1.00 (25.4)	2.00 (50.8)	4.00 (101.6)	4	3	9.00 (228.6)	10,000
PDL-7	A	SL Vinyl	White	2.00 (50.8)	3.94 (100.1)	1.00 (25.4)	2.00 (50.8)	4.00 (101.6)	4	3	9.00 (228.6)	1000
PDL-7B	A	SL Vinyl	Blue/White	2.00 (50.8)	3.94 (100.1)	1.00 (25.4)	2.00 (50.8)	4.00 (101.6)	4	3	9.00 (228.6)	1000
PDL-7G	A	SL Vinyl	Green/White	2.00 (50.8)	3.94 (100.1)	1.00 (25.4)	2.00 (50.8)	4.00 (101.6)	4	3	9.00 (228.6)	1000
PDL-7R	A	SL Vinyl	Red/White	2.00 (50.8)	3.94 (100.1)	1.00 (25.4)	2.00 (50.8)	4.00 (101.6)	4	3	9.00 (228.6)	1000
PDL-7VF	A	Vinyl Free SL	White	2.00 (50.8)	3.94 (100.1)	1.00 (25.4)	2.00 (50.8)	4.00 (101.6)	4	3	9.00 (228.6)	1000
PDL-7Y	A	SL Vinyl	Yellow/White	2.00 (50.8)	3.94 (100.1)	1.00 (25.4)	2.00 (50.8)	4.00 (101.6)	4	3	9.00 (228.6)	1000
PDL-7-2.5	A	SL Vinyl	White	2.00 (50.8)	3.94 (100.1)	1.00 (25.4)	2.00 (50.8)	4.00 (101.6)	4	3	9.00 (228.6)	2500
PDL-7-10	A	SL Vinyl	White	2.00 (50.8)	3.94 (100.1)	1.00 (25.4)	2.00 (50.8)	4.00 (101.6)	4	3	9.00 (228.6)	10,000
PDL-16	B	SL Vinyl	White	2.00 (50.8)	5.94 (150.9)	1.50 (38.1)	2.10 (53.4)	6.00 (152.4)	6	2	13.50 (342.9)‡	1000
PDL-16-2.5	B	SL Vinyl	White	2.00 (50.8)	5.94 (150.9)	1.50 (38.1)	2.10 (53.4)	6.00 (152.4)	6	2	13.50 (342.9)‡	2500
PDL-16-10	B	SL Vinyl	White	2.00 (50.8)	5.94 (150.9)	1.50 (38.1)	2.10 (53.4)	6.00 (152.4)	6	2	13.50 (342.9)‡	10,000
PDL-62	B	SL TEDLAR	White	2.00 (50.8)	5.94 (150.9)	1.50 (38.1)	2.10 (53.4)	6.00 (152.4)	6	2	13.50 (342.9)‡	1000
PDL-133	B	SL Vinyl	White	2.00 (50.8)	5.94 (150.9)	1.50 (38.1)	2.10 (53.4)	6.00 (152.4)	3	2	7.00 (177.8)	1000
PDL-134	B	SL TEDLAR	White	2.00 (50.8)	5.94 (150.9)	1.50 (38.1)	2.10 (53.4)	6.00 (152.4)	3	2	7.00 (177.8)	1000
PDL-17	B	SL Vinyl	White	2.00 (50.8)	7.44 (189.0)	1.50 (38.1)	2.20 (55.9)	7.50 (190.5)	4	1	9.40 (238.8)‡	1000
PDL-17-2.5	B	SL Vinyl	White	2.00 (50.8)	7.44 (189.0)	1.50 (38.1)	2.20 (55.9)	7.50 (190.5)	4	1	9.40 (238.8)‡	2500
PDL-63	B	SL TEDLAR	White	2.00 (50.8)	7.44 (189.0)	1.50 (38.1)	2.20 (55.9)	7.50 (190.5)	4	1	9.40 (238.8)‡	1000
PDL-115	B	SL Vinyl	White	2.00 (50.8)	7.44 (189.0)	1.50 (38.1)	2.20 (55.9)	7.50 (190.5)	3	2	7.20 (182.9)	1000
PDL-115-2.5	B	SL Vinyl	White	2.00 (50.8)	7.44 (189.0)	1.50 (38.1)	2.20 (55.9)	7.50 (190.5)	3	2	7.20 (182.9)	2500
PDL-116	B	SL TEDLAR	White	2.00 (50.8)	7.44 (189.0)	1.50 (38.1)	2.20 (55.9)	7.50 (190.5)	3	2	7.20 (182.9)	1000
PDL-362-1	B	SL Vinyl	White	2.00 (50.8)	9.00 (228.6)	1.50 (38.1)	2.10 (53.4)	9.50 (241.3)	4	1	9.40 (238.8)‡	1000

▲TEDLAR is the registered trademark of E. I. DuPont Co.
 ‡Wide carriage printer required to print this label
 *Order number of labels required in multiples of Std. Pkg. Qty.

PDL Blank Labels by Size



STYLE A - BUTT CUT



STYLE B - DIE CUT

Part Number	Style	Material	Color	Label Width A In. (mm)	Label Length B In. (mm)	Horizontal Repeat D In. (mm)	Vertical Repeat E In. (mm)	Labels Per Row	Rows Per Fanfold	Web Width F In. (mm)	Std. Pkg. Qty.*
PDL-176	B	Vinyl Cloth	White	0.25 (6.4)	1.44 (36.6)	0.25 (6.4)	1.50 (38.1)	36	8	10.00 (254.0)‡	5000
PDL-177	B	Polyester	White	0.25 (6.4)	1.44 (36.6)	0.25 (6.4)	1.50 (38.1)	36	8	10.00 (254.0)‡	5000
PDL-178	B	Vinyl	White	0.25 (6.4)	1.44 (36.6)	0.25 (6.4)	1.50 (38.1)	36	8	10.00 (254.0)‡	5000
PDL-179	B	TEDLAR ▲	White	0.25 (6.4)	1.44 (36.6)	0.25 (6.4)	1.50 (38.1)	36	8	10.00 (254.0)‡	5000
PDL-347	B	Vinyl Cloth	White	0.28 (7.1)	0.25 (6.4)	0.40 (10.2)	0.25 (6.4)	10	2800•	5.00 (127.0)	1 Roll (28,000 Labels)
PDL-7966-10	B	TEDLAR	White	0.30 (7.6)	0.20 (5.1)	0.40 (10.2)	0.33 (8.5)	16	36	7.30 (185.4)	10,000
PDL-252	A	Polyimide	Amber	0.30 (7.6)	0.30 (7.6)	0.30 (7.6)	0.50 (12.7)	16	24	5.80 (147.3)	5000
PDL-252-10	A	Polyimide	Amber	0.30 (7.6)	0.30 (7.6)	0.30 (7.6)	0.50 (12.7)	16	24	5.80 (147.3)	10,000
PDL-253	A	Polyester	White	0.30 (7.6)	0.30 (7.6)	0.30 (7.6)	0.50 (12.7)	16	24	5.80 (147.3)	5000
PDL-253-10	A	Polyester	White	0.30 (7.6)	0.30 (7.6)	0.30 (7.6)	0.50 (12.7)	16	24	5.80 (147.3)	10,000
PDL-254	A	Vinyl Cloth	White	0.30 (7.6)	0.75 (19.1)	0.30 (7.6)	1.00 (25.4)	16	12	5.80 (147.3)	5000
PDL-256	A	TEDLAR	White	0.30 (7.6)	0.75 (19.1)	0.30 (7.6)	1.00 (25.4)	16	12	5.80 (147.3)	5000
PDL-257	A	Vinyl Cloth	White	0.30 (7.6)	0.94 (23.8)	0.30 (7.6)	1.00 (25.4)	16	12	5.80 (147.3)	5000
PDL-259	A	TEDLAR	White	0.30 (7.6)	0.94 (23.8)	0.30 (7.6)	1.00 (25.4)	16	12	5.80 (147.3)	5000
PDL-351	B	Vinyl Cloth	White	0.31 (7.9)	0.38 (9.5)	0.40 (10.2)	0.38 (9.5)	10	1867•	5.00 (127.0)	1 Roll (18,670 Labels)
PDL-353	B	Vinyl Cloth	White	0.31 (7.9)	0.50 (12.7)	0.40 (10.2)	0.50 (12.7)	10	1400•	5.00 (127.0)	1 Roll (14,000 Labels)
PDL-349	Strip	Vinyl Cloth	White	0.31 (7.9)	700 (17780)	0.40 (10.2)	—	10	1•	5.00 (127.0)	1 Roll (10 Strips)
PDL-260	A	Vinyl Cloth	White	0.38 (9.5)	0.38 (9.5)	0.50 (12.7)	0.50 (12.7)	16	24	8.90 (226.1)	5000
PDL-262	A	Polyimide	Amber	0.38 (9.5)	0.38 (9.5)	0.50 (12.7)	0.50 (12.7)	16	24	8.90 (226.1)	5000
PDL-262-10	A	Polyimide	Amber	0.38 (9.5)	0.38 (9.5)	0.50 (12.7)	0.50 (12.7)	16	24	8.90 (226.1)	10,000
PDL-263	A	Destr. Vinyl	White	0.38 (9.5)	0.38 (9.5)	0.50 (12.7)	0.50 (12.7)	16	24	8.90 (226.1)	5000
PDL-264	A	Polyester	White	0.38 (9.5)	0.38 (9.5)	0.50 (12.7)	0.50 (12.7)	16	24	8.90 (226.1)	5000
PDL-264-10	A	Polyester	White	0.38 (9.5)	0.38 (9.5)	0.50 (12.7)	0.50 (12.7)	16	24	8.90 (226.1)	10,000
PDL-180	B	Vinyl Cloth	White	0.38 (9.5)	1.44 (36.6)	0.38 (9.5)	1.50 (38.1)	24	8	10.00 (254.0)‡	5000
PDL-181	B	Polyester	White	0.38 (9.5)	1.44 (36.6)	0.38 (9.5)	1.50 (38.1)	24	8	10.00 (254.0)‡	5000
PDL-182	B	Vinyl	White	0.38 (9.5)	1.44 (36.6)	0.38 (9.5)	1.50 (38.1)	24	8	10.00 (254.0)‡	5000
PDL-183	B	TEDLAR	White	0.38 (9.5)	1.44 (36.6)	0.38 (9.5)	1.50 (38.1)	24	8	10.00 (254.0)‡	5000
PDL-355	Strip	Vinyl Cloth	White	0.38 (9.5)	700 (17780)	0.50 (12.7)	—	8	1•	5.00 (127.0)	1 Roll (8 Strips)
PDL-100	B	TEDLAR	White	0.44 (11.1)	2.56 (65.0)	0.60 (15.2)	3.00 (76.2)	12	4	8.04 (204.2)	5000
PDL-101	B	Polyester	White	0.44 (11.1)	2.56 (65.0)	0.60 (15.2)	3.00 (76.2)	12	4	8.04 (204.2)	5000
PDL-102	B	Vinyl Cloth	White	0.44 (11.1)	2.56 (65.0)	0.60 (15.2)	3.00 (76.2)	12	4	8.04 (204.2)	5000
PDL-103	B	Vinyl	White	0.44 (11.1)	2.56 (65.0)	0.60 (15.2)	3.00 (76.2)	12	4	8.04 (204.2)	5000

▲TEDLAR is the registered trademark of E. I. DuPont Co.

•Indicates label is roll mounted on 3" (76.2 mm) core

‡Wide carriage printer required to print this label

*Order number of labels required in multiples of Std. Pkg. Qty. For roll mounted labels, order number of rolls required in multiples of Std. Pkg. Qty.

PDL Blank Labels by Size (cont.)



STYLE A - BUTT CUT



STYLE B - DIE CUT

Part Number	Style	Material	Color	Label Width A In. (mm)	Label Length B In. (mm)	Horizontal Repeat D In. (mm)	Vertical Repeat E In. (mm)	Labels Per Row	Rows Per Fanfold	Web Width F In. (mm)	Std. Pkg. Qty.*
PDL-104	B	TEDLAR [†]	White	0.44 (11.1)	3.63 (92.1)	0.60 (15.2)	4.00 (101.6)	12	3	8.04 (204.2)	5000
PDL-105	B	Polyester	White	0.44 (11.1)	3.63 (92.1)	0.60 (15.2)	4.00 (101.6)	12	3	8.04 (204.2)	5000
PDL-106-1	B	Vinyl Cloth	White	0.44 (11.1)	3.63 (92.1)	0.60 (15.2)	4.00 (101.6)	12	3	8.04 (204.2)	1000
PDL-106	B	Vinyl Cloth	White	0.44 (11.1)	3.63 (92.1)	0.60 (15.2)	4.00 (101.6)	12	3	8.04 (204.2)	5000
PDL-106-10	B	Vinyl Cloth	White	0.44 (11.1)	3.63 (92.1)	0.60 (15.2)	4.00 (101.6)	12	3	8.04 (204.2)	10,000
PDL-107	B	Vinyl	White	0.44 (11.1)	3.63 (92.1)	0.60 (15.2)	4.00 (101.6)	12	3	8.04 (204.2)	5000
PDL-45-1	A	Vinyl Cloth	White	0.50 (12.7)	0.44 (11.1)	0.50 (12.7)	0.50 (12.7)	16	24	9.00 (228.6)	1000
PDL-45	A	Vinyl Cloth	White	0.50 (12.7)	0.44 (11.1)	0.50 (12.7)	0.50 (12.7)	16	24	9.00 (228.6)	5000
PDL-45-10	A	Vinyl Cloth	White	0.50 (12.7)	0.44 (11.1)	0.50 (12.7)	0.50 (12.7)	16	24	9.00 (228.6)	10,000
PDL-46	A	Destr. Vinyl	White	0.50 (12.7)	0.44 (11.1)	0.50 (12.7)	0.50 (12.7)	16	24	9.00 (228.6)	5000
PDL-47	A	Polyester	White	0.50 (12.7)	0.44 (11.1)	0.50 (12.7)	0.50 (12.7)	16	24	9.00 (228.6)	5000
PDL-47-10	A	Polyester	White	0.50 (12.7)	0.44 (11.1)	0.50 (12.7)	0.50 (12.7)	16	24	9.00 (228.6)	10,000
PDL-48-1	A	Polyester	Silver	0.50 (12.7)	0.44 (11.1)	0.50 (12.7)	0.50 (12.7)	16	24	9.00 (228.6)	1000
PDL-48	A	Polyester	Silver	0.50 (12.7)	0.44 (11.1)	0.50 (12.7)	0.50 (12.7)	16	24	9.00 (228.6)	5000
PDL-48-10	A	Polyester	Silver	0.50 (12.7)	0.44 (11.1)	0.50 (12.7)	0.50 (12.7)	16	24	9.00 (228.6)	10,000
PDL-91	A	Remov. Paper	White	0.50 (12.7)	0.44 (11.1)	0.50 (12.7)	0.50 (12.7)	16	24	9.00 (228.6)	5000
PDL-43	B	Vinyl Cloth	White	0.50 (12.7)	0.75 (19.1)	0.60 (15.2)	1.00 (25.4)	14	12	9.30 (236.2)‡	5000
PDL-43-10	B	Vinyl Cloth	White	0.50 (12.7)	0.75 (19.1)	0.60 (15.2)	1.00 (25.4)	14	12	9.30 (236.2)‡	10,000
PDL-44	B	TEDLAR	White	0.50 (12.7)	0.75 (19.1)	0.60 (15.2)	1.00 (25.4)	14	12	9.30 (236.2)‡	5000
PDL-89	B	Destr. Paper	White	0.50 (12.7)	0.75 (19.1)	0.60 (15.2)	1.00 (25.4)	14	12	9.30 (236.2)‡	5000
PDL-90	B	Polyester	White	0.50 (12.7)	0.75 (19.1)	0.60 (15.2)	1.00 (25.4)	14	12	9.30 (236.2)‡	5000
PDL-119	B	Vinyl Cloth	White	0.50 (12.7)	0.75 (19.1)	0.60 (15.2)	1.00 (25.4)	12	12	8.10 (205.7)	5000
PDL-120	B	TEDLAR	White	0.50 (12.7)	0.75 (19.1)	0.60 (15.2)	1.00 (25.4)	12	12	8.10 (205.7)	5000
PDL-120-10	B	TEDLAR	White	0.50 (12.7)	0.75 (19.1)	0.60 (15.2)	1.00 (25.4)	12	12	8.10 (205.7)	10,000
PDL-121	B	Polyester	White	0.50 (12.7)	0.75 (19.1)	0.60 (15.2)	1.00 (25.4)	12	12	8.10 (205.7)	5000
PDL-122	B	Destr. Paper	White	0.50 (12.7)	0.75 (19.1)	0.60 (15.2)	1.00 (25.4)	12	12	8.10 (205.7)	5000
PDL-265	A	Vinyl Cloth	White	0.50 (12.7)	0.94 (23.8)	0.50 (12.7)	1.00 (25.4)	16	12	9.00 (228.6)	5000
PDL-267	A	TEDLAR	White	0.50 (12.7)	0.94 (23.8)	0.50 (12.7)	1.00 (25.4)	16	12	9.00 (228.6)	5000
PDL-13-1	B	Vinyl Cloth	White	0.50 (12.7)	1.44 (36.5)	0.60 (15.2)	1.50 (38.1)	12	8	8.10 (205.7)	1000
PDL-13	B	Vinyl Cloth	White	0.50 (12.7)	1.44 (36.5)	0.60 (15.2)	1.50 (38.1)	12	8	8.10 (205.7)	5000
PDL-13-10	B	Vinyl Cloth	White	0.50 (12.7)	1.44 (36.5)	0.60 (15.2)	1.50 (38.1)	12	8	8.10 (205.7)	10,000
PDL-14	B	Polyester	White	0.50 (12.7)	1.44 (36.5)	0.60 (15.2)	1.50 (38.1)	12	8	8.10 (205.7)	5000
PDL-14-10	B	Polyester	White	0.50 (12.7)	1.44 (36.5)	0.60 (15.2)	1.50 (38.1)	12	8	8.10 (205.7)	10,000
PDL-15	B	Vinyl	White	0.50 (12.7)	1.44 (36.5)	0.60 (15.2)	1.50 (38.1)	12	8	8.10 (205.7)	5000
PDL-184	B	Vinyl Cloth	White	0.50 (12.7)	1.44 (36.5)	0.50 (12.7)	1.50 (38.1)	18	8	10.00 (254.0)‡	5000
PDL-185	B	Polyester	White	0.50 (12.7)	1.44 (36.5)	0.50 (12.7)	1.50 (38.1)	18	8	10.00 (254.0)‡	5000
PDL-186	B	Vinyl	White	0.50 (12.7)	1.44 (36.5)	0.50 (12.7)	1.50 (38.1)	18	8	10.00 (254.0)‡	5000
PDL-187	B	TEDLAR	White	0.50 (12.7)	1.44 (36.5)	0.50 (12.7)	1.50 (38.1)	18	8	10.00 (254.0)‡	5000

*TEDLAR is the registered trademark of E. I. DuPont Co.
 †Wide carriage printer required to print this label.
 ‡Order number of labels required in multiples of Std. Pkg. Qty.

PDL Blank Labels by Size (cont.)



STYLE A - BUTT CUT



STYLE B - DIE CUT

Part Number	Style	Material	Color	Label Width A In. (mm)	Label Length B In. (mm)	Horizontal Repeat D In. (mm)	Vertical Repeat E In. (mm)	Labels Per Row	Rows Per Fanfold	Web Width F In. (mm)	Std. Pkg. Qty.*
PDL-135 thru PDL-138 have a horizontal slit 0.13" (3.2mm) from top of label (see drawing below)											
PDL-135	B	Vinyl Cloth	White	0.50 (12.7)	1.44 (36.5)	0.60 (15.2)	1.50 (38.1)	12	8	8.10 (205.7)	5000
PDL-136	B	Polyester	White	0.50 (12.7)	1.44 (36.5)	0.60 (15.2)	1.50 (38.1)	12	8	8.10 (205.7)	5000
PDL-137	B	TEDLAR [▲]	White	0.50 (12.7)	1.44 (36.5)	0.60 (15.2)	1.50 (38.1)	12	8	8.10 (205.7)	5000
PDL-138	B	Destr. Paper	White	0.50 (12.7)	1.44 (36.5)	0.60 (15.2)	1.50 (38.1)	12	8	8.10 (205.7)	5000
PDL-402-D	B	Polyester	Clear	0.56 (14.3)	0.19 (4.8)	0.70 (17.8)	0.33 (8.5)	10	36	7.86 (199.6)	500
PDL-402-10	B	Polyester	Clear	0.56 (14.3)	0.19 (4.8)	0.70 (17.8)	0.33 (8.5)	10	36	7.86 (199.6)	10,000
PDL-405-D	B	Polyester	White	0.56 (14.3)	0.19 (4.8)	0.70 (17.8)	0.33 (8.5)	10	36	7.86 (199.6)	500
PDL-405-10	B	Polyester	White	0.56 (14.3)	0.19 (4.8)	0.70 (17.8)	0.33 (8.5)	10	36	7.86 (199.6)	10,000
PDL-400	B	Polyester	Elec. Ivory	0.56 (14.3)	0.56 (14.3)	0.70 (17.8)	0.75 (19.1)	10	16	7.86 (199.6)	5000
PDL-401-D	B	Polyester	Clear	0.56 (14.3)	0.56 (14.3)	0.70 (17.8)	0.75 (19.1)	10	16	7.86 (199.6)	500
PDL-401	B	Polyester	Clear	0.56 (14.3)	0.56 (14.3)	0.70 (17.8)	0.75 (19.1)	10	16	7.86 (199.6)	5000
PDL-401-10	B	Polyester	Clear	0.56 (14.3)	0.56 (14.3)	0.70 (17.8)	0.75 (19.1)	10	16	7.86 (199.6)	10,000
PDL-406-D	B	Polyester	White	0.56 (14.3)	0.56 (14.3)	0.70 (17.8)	0.75 (19.1)	10	16	7.86 (199.6)	500
PDL-406-10	B	Polyester	White	0.56 (14.3)	0.56 (14.3)	0.70 (17.8)	0.75 (19.1)	10	16	7.86 (199.6)	10,000
PDL-193	B	Vinyl Cloth	Yellow	0.59 (15.0)	0.35 (9.0)	0.70 (17.8)	0.50 (12.7)	12	24	9.30 (236.2)‡	5000
PDL-194	B	Vinyl Cloth	White	0.59 (15.0)	0.35 (9.0)	0.70 (17.8)	0.50 (12.7)	12	24	9.30 (236.2)‡	5000
PDL-34-1	B	Vinyl Cloth	White	0.65 (16.5)	0.20 (5.1)	0.80 (20.3)	0.25 (6.4)	10	48	8.85 (224.8)	1000
PDL-34	B	Vinyl Cloth	White	0.65 (16.5)	0.20 (5.1)	0.80 (20.3)	0.25 (6.4)	10	48	8.85 (224.8)	5000
PDL-34-10	B	Vinyl Cloth	White	0.65 (16.5)	0.20 (5.1)	0.80 (20.3)	0.25 (6.4)	10	48	8.85 (224.8)	10,000
PDL-35-1	B	Destr. Vinyl	White	0.65 (16.5)	0.20 (5.1)	0.80 (20.3)	0.25 (6.4)	10	48	8.85 (224.8)	1000
PDL-35	B	Destr. Vinyl	White	0.65 (16.5)	0.20 (5.1)	0.80 (20.3)	0.25 (6.4)	10	48	8.85 (224.8)	5000
PDL-35-10	B	Destr. Vinyl	White	0.65 (16.5)	0.20 (5.1)	0.80 (20.3)	0.25 (6.4)	10	48	8.85 (224.8)	10,000
PDL-36	B	Polyester	White	0.65 (16.5)	0.20 (5.1)	0.80 (20.3)	0.25 (6.4)	10	48	8.85 (224.8)	5000
PDL-36-10	B	Polyester	White	0.65 (16.5)	0.20 (5.1)	0.80 (20.3)	0.25 (6.4)	10	48	8.85 (224.8)	10,000
PDL-82	B	Destr. Paper	White	0.65 (16.5)	0.20 (5.1)	0.80 (20.3)	0.25 (6.4)	10	48	8.85 (224.8)	5000
PDL-83	B	TEDLAR	White	0.65 (16.5)	0.20 (5.1)	0.80 (20.3)	0.25 (6.4)	10	48	8.85 (224.8)	5000
PDL-83-10	B	TEDLAR	White	0.65 (16.5)	0.20 (5.1)	0.80 (20.3)	0.25 (6.4)	10	48	8.85 (224.8)	10,000
PDL-189	B	Vinyl	White	0.65 (16.5)	0.20 (5.1)	0.80 (20.3)	0.25 (6.4)	10	48	8.85 (224.8)	5000
PDL-233	B	Polyimide	Amber	0.65 (16.5)	0.20 (5.1)	0.80 (20.3)	0.25 (6.4)	10	48	8.85 (224.8)	5000
PDL-233-10	B	Polyimide	Amber	0.65 (16.5)	0.20 (5.1)	0.80 (20.3)	0.25 (6.4)	10	48	8.85 (224.8)	10,000
PDL-234	B	Polyester	Silver	0.65 (16.5)	0.20 (5.1)	0.80 (20.3)	0.25 (6.4)	10	48	8.85 (224.8)	5000
PDL-234-10	B	Polyester	Silver	0.65 (16.5)	0.20 (5.1)	0.80 (20.3)	0.25 (6.4)	10	48	8.85 (224.8)	10,000
PDL-269 has tamper resistant slits (see drawing below)											
PDL-269	B	Polyester	White	0.65 (16.5)	0.20 (5.1)	0.80 (20.3)	0.25 (6.4)	10	48	8.85 (224.8)	5000

▲TEDLAR is the registered trademark of E. I. DuPont Co.
 ‡Wide carriage printer required to print this label
 *Order number of labels required in multiples of Std. Pkg. Qty.

PDL-135
 PDL-136
 PDL-137
 PDL-138



PDL-269



PDL Blank Labels by Size (cont.)



STYLE A - BUTT CUT



STYLE B - DIE CUT

Part Number	Style	Material	Color	Label Width A In. (mm)	Label Length B In. (mm)	Horizontal Repeat D In. (mm)	Vertical Repeat E In. (mm)	Labels Per Row	Rows Per Fanfold	Web Width F In. (mm)	Std. Pkg. Qty.*
PDL-37-1	B	Vinyl Cloth	White	0.75 (19.1)	0.25 (6.4)	0.90 (22.9)	0.33 (8.5)	9	36	9.00 (228.6)	1000
PDL-37	B	Vinyl Cloth	White	0.75 (19.1)	0.25 (6.4)	0.90 (22.9)	0.33 (8.5)	9	36	9.00 (228.6)	5000
PDL-37-10	B	Vinyl Cloth	White	0.75 (19.1)	0.25 (6.4)	0.90 (22.9)	0.33 (8.5)	9	36	9.00 (228.6)	10,000
PDL-37-50	B	Vinyl Cloth	White	0.75 (19.1)	0.25 (6.4)	0.90 (22.9)	0.33 (8.5)	9	36	9.00 (228.6)	50,000
PDL-38	B	Destr. Vinyl	White	0.75 (19.1)	0.25 (6.4)	0.90 (22.9)	0.33 (8.5)	9	36	9.00 (228.6)	5000
PDL-38-10	B	Destr. Vinyl	White	0.75 (19.1)	0.25 (6.4)	0.90 (22.9)	0.33 (8.5)	9	36	9.00 (228.6)	10,000
PDL-39	B	Polyester	White	0.75 (19.1)	0.25 (6.4)	0.90 (22.9)	0.33 (8.5)	9	36	9.00 (228.6)	5000
PDL-39-10	B	Polyester	White	0.75 (19.1)	0.25 (6.4)	0.90 (22.9)	0.33 (8.5)	9	36	9.00 (228.6)	10,000
PDL-84	B	TEDLAR ▲	White	0.75 (19.1)	0.25 (6.4)	0.90 (22.9)	0.33 (8.5)	9	36	9.00 (228.6)	5000
PDL-85	B	Destr. Paper	White	0.75 (19.1)	0.25 (6.4)	0.90 (22.9)	0.33 (8.5)	9	36	9.00 (228.6)	5000
PDL-190	B	Vinyl	White	0.75 (19.1)	0.25 (6.4)	0.90 (22.9)	0.33 (8.5)	9	36	9.00 (228.6)	5000
PDL-235	B	Polyimide	Amber	0.75 (19.1)	0.25 (6.4)	0.90 (22.9)	0.33 (8.5)	9	36	9.00 (228.6)	5000
PDL-235-10	B	Polyimide	Amber	0.75 (19.1)	0.25 (6.4)	0.90 (22.9)	0.33 (8.5)	9	36	9.00 (228.6)	10,000
PDL-236	B	Polyester	Silver	0.75 (19.1)	0.25 (6.4)	0.90 (22.9)	0.33 (8.5)	9	36	9.00 (228.6)	5000
PDL-236-10	B	Polyester	Silver	0.75 (19.1)	0.25 (6.4)	0.90 (22.9)	0.33 (8.5)	9	36	9.00 (228.6)	10,000
PDL-270	B	Vinyl Cloth	White	0.75 (19.1)	0.25 (6.4)	0.90 (22.9)	0.38 (9.5)	9	32	9.00 (228.6)	5000
PDL-272	B	Polyimide	Amber	0.75 (19.1)	0.25 (6.4)	0.90 (22.9)	0.38 (9.5)	9	32	9.00 (228.6)	5000
PDL-273	B	Destr. Vinyl	White	0.75 (19.1)	0.25 (6.4)	0.90 (22.9)	0.38 (9.5)	9	32	9.00 (228.6)	5000
PDL-274	B	Polyester	White	0.75 (19.1)	0.25 (6.4)	0.90 (22.9)	0.38 (9.5)	9	32	9.00 (228.6)	5000
PDL-274-10	B	Polyester	White	0.75 (19.1)	0.25 (6.4)	0.90 (22.9)	0.38 (9.5)	9	32	9.00 (228.6)	10,000
PDL-275	B	Polyester	Silver	0.75 (19.1)	0.25 (6.4)	0.90 (22.9)	0.38 (9.5)	9	32	9.00 (228.6)	5000
PDL-276 thru PDL-277-10 have tamper resistant slits (see drawing below)											
PDL-276	B	Polyimide	Amber	0.75 (19.1)	0.25 (6.4)	0.90 (22.9)	0.33 (8.5)	9	36	9.00 (228.6)	5000
PDL-277	B	Polyester	White	0.75 (19.1)	0.25 (6.4)	0.90 (22.9)	0.33 (8.5)	9	36	9.00 (228.6)	5000
PDL-277-10	B	Polyester	White	0.75 (19.1)	0.25 (6.4)	0.90 (22.9)	0.33 (8.5)	9	36	9.00 (228.6)	10,000
PDL-191	B	Vinyl Cloth	Yellow	0.79 (20.0)	0.32 (8.0)	0.90 (22.9)	0.50 (12.7)	9	24	9.00 (228.6)	5000
PDL-192	B	Vinyl Cloth	White	0.79 (20.0)	0.32 (8.0)	0.90 (22.9)	0.50 (12.7)	9	24	9.00 (228.6)	5000
PDL-278	A	Polyimide	Amber	0.80 (20.3)	0.20 (5.1)	0.80 (20.3)	0.33 (8.5)	10	36	9.00 (228.6)	5000
PDL-279	A	Polyester	White	0.80 (20.3)	0.20 (5.1)	0.80 (20.3)	0.33 (8.5)	10	36	9.00 (228.6)	5000
PDL-279-10	A	Polyester	White	0.80 (20.3)	0.20 (5.1)	0.80 (20.3)	0.33 (8.5)	10	36	9.00 (228.6)	10,000
PDL-167	B	Destr. Paper	White	0.80 (20.3)	0.25 (6.4)	0.80 (20.3)	0.38 (9.5)	10	32	9.00 (228.6)	5000
PDL-170	B	Remov. Paper	White	0.80 (20.3)	0.50 (12.7)	0.80 (20.3)	0.63 (15.9)	10	16	9.00 (228.6)	5000
PDL-170-10	B	Remov. Paper	White	0.80 (20.3)	0.50 (12.7)	0.80 (20.3)	0.63 (15.9)	10	16	9.00 (228.6)	10,000
PDL-171	B	Vinyl	White	0.80 (20.3)	0.50 (12.7)	0.80 (20.3)	0.63 (15.9)	10	16	9.00 (228.6)	5000
PDL-172	B	Polyester	White	0.80 (20.3)	0.50 (12.7)	0.80 (20.3)	0.63 (15.9)	10	16	9.00 (228.6)	5000
PDL-172-10	B	Polyester	White	0.80 (20.3)	0.50 (12.7)	0.80 (20.3)	0.63 (15.9)	10	16	9.00 (228.6)	10,000
PDL-173	B	Polyimide	Amber	0.80 (20.3)	0.50 (12.7)	0.80 (20.3)	0.63 (15.9)	10	16	9.00 (228.6)	5000
PDL-174	B	Destr. Paper	White	0.80 (20.3)	0.50 (12.7)	0.80 (20.3)	0.63 (15.9)	10	16	9.00 (228.6)	5000
PDL-172R	B	Polyester	White	0.80 (20.3)	0.50 (12.7)	0.80 (20.3)	0.63 (15.9)	10	1000*	9.00 (228.6)	1 Roll (10,000 Labels)

*TEDLAR is the registered trademark of E. I. DuPont Co.

*Indicates label is roll mounted on 3" (76.2 mm) core

*Order number of labels required in multiples of Std. Pkg. Qty. For roll mounted labels, order number of rolls required in multiples of Std. Pkg. Qty.

PDL-276
PDL-277
PDL-277-10



PDL Blank Labels by Size (cont.)

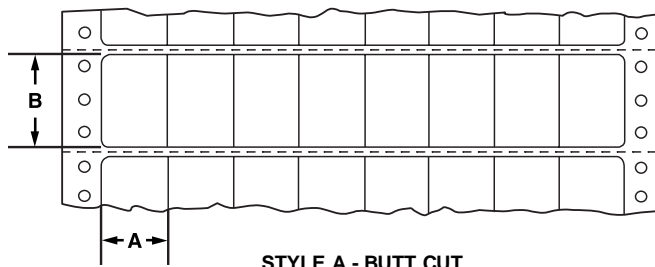

STYLE A - BUTT CUT

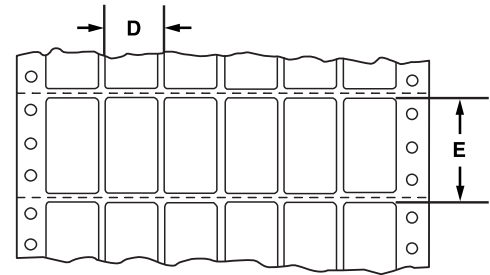

STYLE B - DIE CUT

Part Number	Style	Material	Color	Label Width A In. (mm)	Label Length B In. (mm)	Horizontal Repeat D In. (mm)	Vertical Repeat E In. (mm)	Labels Per Row	Rows Per Fanfold	Web Width F In. (mm)	Std. Pkg. Qty.*
PDL-280	A	Vinyl Cloth	White	0.80 (20.3)	0.94 (23.8)	0.80 (20.3)	1.00 (25.4)	10	12	9.00 (228.6)	5000
PDL-280-10	A	Vinyl Cloth	White	0.80 (20.3)	0.94 (23.8)	0.80 (20.3)	1.00 (25.4)	10	12	9.00 (228.6)	10,000
PDL-282	A	TEDLAR ▲	White	0.80 (20.3)	0.94 (23.8)	0.80 (20.3)	1.00 (25.4)	10	12	9.00 (228.6)	5000
PDL-9	B	Vinyl Cloth	White	0.80 (20.3)	1.44 (36.5)	0.90 (22.9)	1.50 (38.1)	6	8	6.30 (160.0)	5000
PDL-9-10	B	Vinyl Cloth	White	0.80 (20.3)	1.44 (36.5)	0.90 (22.9)	1.50 (38.1)	6	8	6.30 (160.0)	10,000
PDL-9-10T On Thin Liner	B	Vinyl Cloth	White	0.80 (20.3)	1.44 (36.5)	0.90 (22.9)	1.50 (38.1)	6	8	6.30 (160.0)	10,000
PDL-10-1	B	TEDLAR	White	0.80 (20.3)	1.44 (36.5)	0.90 (22.9)	1.50 (38.1)	6	8	6.30 (160.0)	1000
PDL-10	B	TEDLAR	White	0.80 (20.3)	1.44 (36.5)	0.90 (22.9)	1.50 (38.1)	6	8	6.30 (160.0)	5000
PDL-11	B	Vinyl	White	0.80 (20.3)	1.44 (36.5)	0.90 (22.9)	1.50 (38.1)	6	8	6.30 (160.0)	5000
PDL-175	B	Polyester	Silver	0.81 (20.7)	0.50 (12.7)	0.80 (20.3)	0.63 (15.9)	10	16	9.00 (228.6)	5000
PDL-23-1	B	TEDLAR	White	0.90 (22.9)	0.25 (6.4)	1.00 (25.4)	0.33 (8.5)	10	36	10.90 (276.9)‡	1000
PDL-23	B	TEDLAR	White	0.90 (22.9)	0.25 (6.4)	1.00 (25.4)	0.33 (8.5)	10	36	10.90 (276.9)‡	5000
PDL-23-10	B	TEDLAR	White	0.90 (22.9)	0.25 (6.4)	1.00 (25.4)	0.33 (8.5)	10	36	10.90 (276.9)‡	10,000
PDL-49	B	TEDLAR	White	0.90 (22.9)	0.25 (6.4)	1.00 (25.4)	0.33 (8.5)	8	36	8.90 (226.1)	5000
PDL-49-10	B	TEDLAR	White	0.90 (22.9)	0.25 (6.4)	1.00 (25.4)	0.33 (8.5)	8	36	8.90 (226.1)	10,000
PDL-50	B	Polyimide	Amber	0.90 (22.9)	0.25 (6.4)	1.00 (25.4)	0.33 (8.5)	8	36	8.90 (226.1)	5000
PDL-50-10	B	Polyimide	Amber	0.90 (22.9)	0.25 (6.4)	1.00 (25.4)	0.33 (8.5)	8	36	8.90 (226.1)	10,000
PDL-66	B	Vinyl Cloth	White	0.90 (22.9)	0.25 (6.4)	1.00 (25.4)	0.33 (8.5)	10	36	10.90 (276.9)‡	5000
PDL-67	B	Destr. Paper	White	0.90 (22.9)	0.25 (6.4)	1.00 (25.4)	0.33 (8.5)	10	36	10.90 (276.9)‡	5000
PDL-68	B	Polyester	Silver	0.90 (22.9)	0.25 (6.4)	1.00 (25.4)	0.33 (8.5)	10	36	10.90 (276.9)‡	5000
PDL-92	B	Destr. Paper	White	0.90 (22.9)	0.25 (6.4)	1.00 (25.4)	0.33 (8.5)	8	36	8.90 (226.1)	5000
PDL-93	B	Vinyl Cloth	White	0.90 (22.9)	0.25 (6.4)	1.00 (25.4)	0.33 (8.5)	8	36	8.90 (226.1)	5000
PDL-94-1	B	Polyester	White	0.90 (22.9)	0.25 (6.4)	1.00 (25.4)	0.33 (8.5)	8	36	8.90 (226.1)	1000
PDL-94	B	Polyester	White	0.90 (22.9)	0.25 (6.4)	1.00 (25.4)	0.33 (8.5)	8	36	8.90 (226.1)	5000
PDL-94-10	B	Polyester	White	0.90 (22.9)	0.25 (6.4)	1.00 (25.4)	0.33 (8.5)	8	36	8.90 (226.1)	10,000
PDL-283	B	Polyimide	Amber	0.90 (22.9)	0.25 (6.4)	1.00 (25.4)	0.38 (9.5)	8	32	8.90 (226.1)	5000
PDL-284	B	TEDLAR	White	0.90 (22.9)	0.25 (6.4)	1.00 (25.4)	0.38 (9.5)	8	32	8.90 (226.1)	5000
PDL-285	B	Polyester	White	0.90 (22.9)	0.25 (6.4)	1.00 (25.4)	0.38 (9.5)	8	32	8.90 (226.1)	5000
PDL-286 and PDL-287 have tamper resistant slits (see drawing below)											
PDL-286	B	Polyimide	Amber	0.90 (22.9)	0.25 (6.4)	1.00 (25.4)	0.33 (8.5)	8	36	8.90 (226.1)	5000
PDL-287	B	Polyester	White	0.90 (22.9)	0.25 (6.4)	1.00 (25.4)	0.33 (8.5)	8	36	8.90 (226.1)	5000
PDL-4565-1	B	TEDLAR	White	0.98 (25.0)	0.59 (15.0)	1.11 (28.2)	0.75 (19.1)	7	16	8.62 (219.0)	5000
PDL-30-1	B	Vinyl Cloth	White	1.00 (25.4)	0.38 (9.5)	1.10 (27.9)	0.50 (12.7)	7	24	8.60 (218.4)	1000
PDL-30	B	Vinyl Cloth	White	1.00 (25.4)	0.38 (9.5)	1.10 (27.9)	0.50 (12.7)	7	24	8.60 (218.4)	5000
PDL-30-10	B	Vinyl Cloth	White	1.00 (25.4)	0.38 (9.5)	1.10 (27.9)	0.50 (12.7)	7	24	8.60 (218.4)	10,000
PDL-31	B	Polyester	White	1.00 (25.4)	0.38 (9.5)	1.10 (27.9)	0.50 (12.7)	7	24	8.60 (218.4)	5000
PDL-31-10	B	Polyester	White	1.00 (25.4)	0.38 (9.5)	1.10 (27.9)	0.50 (12.7)	7	24	8.60 (218.4)	10,000
PDL-74	B	Destr. Paper	White	1.00 (25.4)	0.38 (9.5)	1.10 (27.9)	0.50 (12.7)	7	24	8.60 (218.4)	5000
PDL-75	B	TEDLAR	White	1.00 (25.4)	0.38 (9.5)	1.10 (27.9)	0.50 (12.7)	7	24	8.60 (218.4)	5000

▲TEDLAR is the registered trademark of E. I. DuPont Co.
‡Wide carriage printer required to print this label
*Order number of labels required in multiples of Std. Pkg. Qty.



PDL Blank Labels by Size (cont.)



STYLE A - BUTT CUT



STYLE B - DIE CUT

Part Number	Style	Material	Color	Label Width A In. (mm)	Label Length B In. (mm)	Horizontal Repeat D In. (mm)	Vertical Repeat E In. (mm)	Labels Per Row	Rows Per Fanfold	Web Width F In. (mm)	Std. Pkg. Qty.*
PDL-19-1	B	Vinyl Cloth	White	1.00 (25.4)	0.50 (12.7)	1.10 (27.9)	0.67 (16.9)	7	18	8.60 (218.4)	1000
PDL-19	B	Vinyl Cloth	White	1.00 (25.4)	0.50 (12.7)	1.10 (27.9)	0.67 (16.9)	7	18	8.60 (218.4)	5000
PDL-19-10	B	Vinyl Cloth	White	1.00 (25.4)	0.50 (12.7)	1.10 (27.9)	0.67 (16.9)	7	18	8.60 (218.4)	10,000
PDL-20-1	B	Polyester	White	1.00 (25.4)	0.50 (12.7)	1.10 (27.9)	0.67 (16.9)	7	18	8.60 (218.4)	1000
PDL-20	B	Polyester	White	1.00 (25.4)	0.50 (12.7)	1.10 (27.9)	0.67 (16.9)	7	18	8.60 (218.4)	5000
PDL-20-10	B	Polyester	White	1.00 (25.4)	0.50 (12.7)	1.10 (27.9)	0.67 (16.9)	7	18	8.60 (218.4)	10,000
PDL-21-1	B	Destr. Vinyl	White	1.00 (25.4)	0.50 (12.7)	1.10 (27.9)	0.67 (16.9)	7	18	8.60 (218.4)	1000
PDL-21	B	Destr. Vinyl	White	1.00 (25.4)	0.50 (12.7)	1.10 (27.9)	0.67 (16.9)	7	18	8.60 (218.4)	5000
PDL-21-10	B	Destr. Vinyl	White	1.00 (25.4)	0.50 (12.7)	1.10 (27.9)	0.67 (16.9)	7	18	8.60 (218.4)	10,000
PDL-22-1	B	Polyester	Silver	1.00 (25.4)	0.50 (12.7)	1.10 (27.9)	0.67 (16.9)	7	18	8.60 (218.4)	1000
PDL-22	B	Polyester	Silver	1.00 (25.4)	0.50 (12.7)	1.10 (27.9)	0.67 (16.9)	7	18	8.60 (218.4)	5000
PDL-22-10	B	Polyester	Silver	1.00 (25.4)	0.50 (12.7)	1.10 (27.9)	0.67 (16.9)	7	18	8.60 (218.4)	10,000
PDL-65	B	Remov. Paper	White	1.00 (25.4)	0.50 (12.7)	1.10 (27.9)	0.67 (16.9)	7	18	8.60 (218.4)	5000
PDL-97	B	Aluminum	Silver	1.00 (25.4)	0.50 (12.7)	1.10 (27.9)	0.67 (16.9)	7	18	8.60 (218.4)	5000
PDL-98	B	Polyimide	Amber	1.00 (25.4)	0.50 (12.7)	1.10 (27.9)	0.67 (16.9)	7	18	8.60 (218.4)	5000
PDL-99	B	TEDLAR ▲	White	1.00 (25.4)	0.50 (12.7)	1.10 (27.9)	0.67 (16.9)	7	18	8.60 (218.4)	5000
PDL-99-10	B	TEDLAR	White	1.00 (25.4)	0.50 (12.7)	1.10 (27.9)	0.67 (16.9)	7	18	8.60 (218.4)	10,000
PDL-157	B	Polyester	White	1.00 (25.4)	0.50 (12.7)	1.13 (28.7)	0.67 (16.9)	5	18	6.52 (165.6)	5000
PDL-158	B	Polyester	Silver	1.00 (25.4)	0.50 (12.7)	1.13 (28.7)	0.67 (16.9)	5	18	6.52 (165.6)	5000
PDL-188	B	Vinyl	White	1.00 (25.4)	0.50 (12.7)	1.10 (27.9)	0.67 (16.9)	7	18	8.60 (218.4)	5000
PDL-230	B	TEDLAR	Yellow	1.00 (25.4)	0.50 (12.7)	1.10 (27.9)	0.67 (16.9)	7	18	8.60 (218.4)	5000
PDL-363	B	Polyester	Clear	1.00 (25.4)	0.50 (12.7)	1.10 (27.9)	0.67 (16.9)	7	18	8.60 (218.4)	5000
PDL-7294-1	B	Destr. Vinyl	White	1.00 (25.4)	0.50 (12.7)	1.60 (40.6)	0.67 (16.9)	3	18	5.70 (144.8)	5000
PDL-288	B	Vinyl Cloth	White	1.00 (25.4)	0.75 (19.1)	1.10 (27.9)	1.00 (25.4)	7	12	8.60 (218.4)	5000
PDL-290	B	TEDLAR	White	1.00 (25.4)	0.75 (19.1)	1.10 (27.9)	1.00 (25.4)	7	12	8.60 (218.4)	5000
PDL-290-1	B	TEDLAR	White	1.00 (25.4)	0.75 (19.1)	1.10 (27.9)	1.00 (25.4)	7	12	8.60 (218.4)	1000
PDL-291	A	Vinyl Cloth	White	1.00 (25.4)	0.94 (23.8)	1.00 (25.4)	1.00 (25.4)	8	12	9.00 (228.6)	5000
PDL-293	A	TEDLAR	White	1.00 (25.4)	0.94 (23.8)	1.00 (25.4)	1.00 (25.4)	8	12	9.00 (228.6)	5000
PDL-294 and PDL-296 have a horizontal perforation 0.72" (18.3mm) from the top (see drawing below)											
PDL-294	B	Vinyl Cloth	White	1.00 (25.4)	1.44 (36.5)	1.10 (27.9)	1.50 (38.1)	7	8	8.60 (218.4)	5000
PDL-296	B	TEDLAR	White	1.00 (25.4)	1.44 (36.5)	1.10 (27.9)	1.50 (38.1)	7	8	8.60 (218.4)	5000
PDL-4674-1	B	Vinyl Cloth	White	1.13 (28.6)	0.53 (13.5)	1.60 (40.6)	0.63 (15.9)	4	16	7.30 (185.4)	20,000
PDL-4674-3	B	TEDLAR	White	1.13 (28.6)	0.53 (13.5)	1.60 (40.6)	0.63 (15.9)	4	16	7.30 (185.4)	20,000
PDL-4565-2	B	TEDLAR	White	1.18 (30.0)	0.37 (9.5)	1.30 (33.0)	0.50 (12.7)	6	24	8.62 (219.0)	5000

*TEDLAR is the registered trademark of E. I. DuPont Co.
*Order number of labels required in multiples of Std. Pkg. Qty.

PDL-294
PDL-296



PDL Blank Labels by Size (cont.)



STYLE A - BUTT CUT



STYLE B - DIE CUT

Part Number	Style	Material	Color	Label Width A In. (mm)	Label Length B In. (mm)	Horizontal Repeat D In. (mm)	Vertical Repeat E In. (mm)	Labels Per Row	Rows Per Fanfold	Web Width F In. (mm)	Std. Pkg. Qty.*
PDL-24	B	TEDLAR *	Yellow	1.25 (31.8)	0.38 (9.5)	1.40 (35.6)	0.50 (12.7)	7	24	10.75 (273.1)‡	5000
PDL-25	B	TEDLAR	White	1.25 (31.8)	0.38 (9.5)	1.40 (35.6)	0.50 (12.7)	7	24	10.75 (273.1)‡	5000
PDL-25-10	B	TEDLAR	White	1.25 (31.8)	0.38 (9.5)	1.40 (35.6)	0.50 (12.7)	7	24	10.75 (273.1)‡	10,000
PDL-26	B	TEDLAR	Silver	1.25 (31.8)	0.38 (9.5)	1.40 (35.6)	0.50 (12.7)	7	24	10.75 (273.1)‡	5000
PDL-69	B	Vinyl Cloth	White	1.25 (31.8)	0.38 (9.5)	1.40 (35.6)	0.50 (12.7)	7	24	10.75 (273.1)‡	5000
PDL-70	B	Destr. Paper	White	1.25 (31.8)	0.38 (9.5)	1.40 (35.6)	0.50 (12.7)	7	24	10.75 (273.1)‡	5000
PDL-71	B	Polyester	White	1.25 (31.8)	0.38 (9.5)	1.40 (35.6)	0.50 (12.7)	7	24	10.75 (273.1)‡	5000
PDL-127	B	TEDLAR	Yellow	1.25 (31.8)	0.38 (9.5)	1.40 (35.6)	0.50 (12.7)	5	24	7.95 (201.9)	5000
PDL-128	B	TEDLAR	White	1.25 (31.8)	0.38 (9.5)	1.40 (35.6)	0.50 (12.7)	5	24	7.95 (201.9)	5000
PDL-128-10	B	TEDLAR	White	1.25 (31.8)	0.38 (9.5)	1.40 (35.6)	0.50 (12.7)	5	24	7.95 (201.9)	10,000
PDL-129	B	TEDLAR	Gray	1.25 (31.8)	0.38 (9.5)	1.40 (35.6)	0.50 (12.7)	5	24	7.95 (201.9)	5000
PDL-130	B	Vinyl Cloth	White	1.25 (31.8)	0.38 (9.5)	1.40 (35.6)	0.50 (12.7)	5	24	7.95 (201.9)	5000
PDL-131	B	Polyester	White	1.25 (31.8)	0.38 (9.5)	1.40 (35.6)	0.50 (12.7)	5	24	7.95 (201.9)	5000
PDL-132	B	Vinyl	White	1.25 (31.8)	0.38 (9.5)	1.40 (35.6)	0.50 (12.7)	5	24	7.95 (201.9)	5000
PDL-132-10	B	Vinyl	White	1.25 (31.8)	0.38 (9.5)	1.40 (35.6)	0.50 (12.7)	5	24	7.95 (201.9)	10,000
PDL-370	B	Destr. Paper	White	1.25 (31.8)	0.38 (9.5)	1.40 (35.6)	0.50 (12.7)	5	24	7.95 (201.9)	5000
PDL-5712-2	B	Polyester	White with Red Border	1.25 (31.8)	0.38 (9.5)	1.40 (35.6)	0.50 (12.7)	5	24	7.95 (201.9)	25,000
PDL-407-1	B	Polyester	Clear	1.38 (34.9)	0.28 (7.1)	1.50 (38.1)	0.50 (12.7)	3	24	5.38 (136.5)	1000
PDL-409-1	B	Polyester	White	1.38 (34.9)	0.28 (7.1)	1.50 (38.1)	0.50 (12.7)	3	24	5.38 (136.5)	1000
PDL-357	B	Polyimide	Amber	1.50 (38.1)	0.25 (6.4)	1.60 (40.6)	0.38 (9.5)	4	32	7.30 (185.4)	5000
PDL-358	B	Polyester	White	1.50 (38.1)	0.25 (6.4)	1.60 (40.6)	0.38 (9.5)	4	32	7.30 (185.4)	5000
PDL-7542-10	B	Polyester	Silver	1.50 (38.1)	0.25 (6.4)	1.60 (40.6)	0.38 (9.5)	4	32	7.30 (185.4)	10,000
PDL-40 thru PDL-629 have a vertical perforation 0.75" (19.1 mm) from the left (see drawing below)											
PDL-40	B	Remov. Paper	White	1.50 (38.1)	0.25 (6.4)	1.83 (46.5)	0.33 (8.5)	4	36	8.00 (203.2)	5000
PDL-40-10	B	Remov. Paper	White	1.50 (38.1)	0.25 (6.4)	1.83 (46.5)	0.33 (8.5)	4	36	8.00 (203.2)	10,000
PDL-41-1	B	Vinyl Cloth	White	1.50 (38.1)	0.25 (6.4)	1.83 (46.5)	0.33 (8.5)	4	36	8.00 (203.2)	1000
PDL-41	B	Vinyl Cloth	White	1.50 (38.1)	0.25 (6.4)	1.83 (46.5)	0.33 (8.5)	4	36	8.00 (203.2)	5000
PDL-41-10	B	Vinyl Cloth	White	1.50 (38.1)	0.25 (6.4)	1.83 (46.5)	0.33 (8.5)	4	36	8.00 (203.2)	10,000
PDL-86	B	TEDLAR	White	1.50 (38.1)	0.25 (6.4)	1.83 (46.5)	0.33 (8.5)	4	36	8.00 (203.2)	5000
PDL-87	B	Polyester	White	1.50 (38.1)	0.25 (6.4)	1.83 (46.5)	0.33 (8.5)	4	36	8.00 (203.2)	5000
PDL-87-10	B	Polyester	White	1.50 (38.1)	0.25 (6.4)	1.83 (46.5)	0.33 (8.5)	4	36	8.00 (203.2)	10,000
PDL-359-10	B	Remov. Paper	White	1.50 (38.1)	0.25 (6.4)	1.80 (45.7)	0.33 (8.5)	4	36	7.90 (200.7)	10,000
PDL-360-10	B	Vinyl Cloth	White	1.50 (38.1)	0.25 (6.4)	1.80 (45.7)	0.33 (8.5)	4	36	7.90 (200.7)	10,000
PDL-629	B	Vinyl	White	1.50 (38.1)	0.25 (6.4)	1.60 (40.6)	0.50 (12.7)	4	24	7.30 (185.4)	5000

*TEDLAR is the registered trademark of E. I. DuPont Co.
 †Wide carriage printer required to print this label
 *Order number of labels required in multiples of Std. Pkg. Qty.

PDL-40
PDL-41
PDL-86

PDL-87
PDL-359
PDL-360
PDL-629



PDL Blank Labels by Size (cont.)

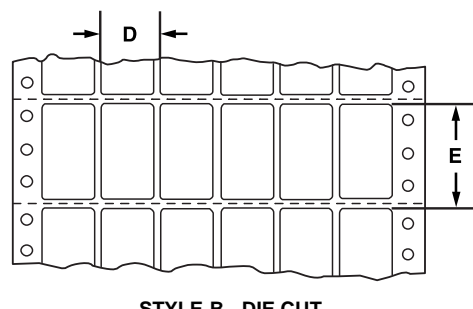
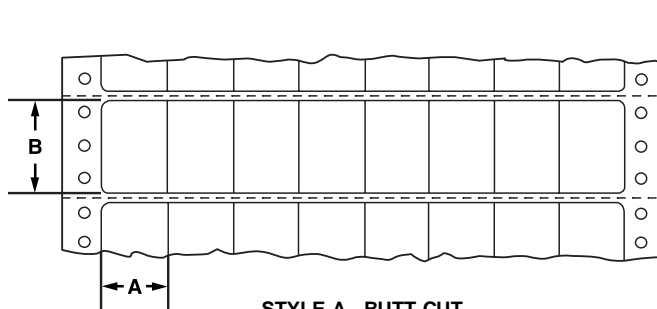

Part Number	Style	Material	Color	Label Width A In. (mm)	Label Length B In. (mm)	Horizontal Repeat D In. (mm)	Vertical Repeat E In. (mm)	Labels Per Row	Rows Per Fanfold	Web Width F In. (mm)	Std. Pkg. Qty.*
PDL-27	B	TEDLAR ^	White	1.50 (38.1)	0.75 (19.1)	1.70 (43.2)	1.00 (25.4)	4	12	7.6 (193.6)	5000
PDL-27-10	B	TEDLAR	White	1.50 (38.1)	0.75 (19.1)	1.70 (43.2)	1.00 (25.4)	4	12	7.6 (193.6)	10,000
PDL-28	B	TEDLAR	Yellow	1.50 (38.1)	0.75 (19.1)	1.70 (43.2)	1.00 (25.4)	4	12	7.6 (193.6)	5000
PDL-29-1	B	Polyester	Silver	1.50 (38.1)	0.75 (19.1)	1.70 (43.2)	1.00 (25.4)	4	12	7.6 (193.6)	1000
PDL-29	B	Polyester	Silver	1.50 (38.1)	0.75 (19.1)	1.70 (43.2)	1.00 (25.4)	4	12	7.6 (193.6)	5000
PDL-29-10	B	Polyester	Silver	1.50 (38.1)	0.75 (19.1)	1.70 (43.2)	1.00 (25.4)	4	12	7.6 (193.6)	10,000
PDL-72	B	Vinyl Cloth	White	1.50 (38.1)	0.75 (19.1)	1.70 (43.2)	1.00 (25.4)	4	12	7.6 (193.6)	5000
PDL-73	B	Destr. Paper	White	1.50 (38.1)	0.75 (19.1)	1.70 (43.2)	1.00 (25.4)	4	12	7.6 (193.6)	5000
PDL-73-10	B	Destr. Paper	White	1.50 (38.1)	0.75 (19.1)	1.70 (43.2)	1.00 (25.4)	4	12	7.6 (193.6)	10,000
PDL-231	B	Polyester	White	1.50 (38.1)	0.75 (19.1)	1.70 (43.2)	1.00 (25.4)	4	12	7.6 (193.6)	5000
PDL-231-10	B	Polyester	White	1.50 (38.1)	0.75 (19.1)	1.70 (43.2)	1.00 (25.4)	4	12	7.6 (193.6)	10,000
PDL-297	B	Vinyl Cloth	Yellow	1.50 (38.1)	0.90 (22.9)	1.60 (40.6)	1.00 (25.4)	5	12	9.00 (228.6)	1000
PDL-298	B	Vinyl Cloth	White	1.50 (38.1)	0.90 (22.9)	1.60 (40.6)	1.00 (25.4)	5	12	9.00 (228.6)	1000
PDL-7572-1R	A	Polyester	Silver	1.63 (41.3)	0.38 (9.5)	1.63 (41.3)	0.38 (9.5)	5	2000•	9.13 (231.9)‡	1000
PDL-7572-10R	A	Polyester	Silver	1.63 (41.3)	0.38 (9.5)	1.63 (41.3)	0.38 (9.5)	5	200•	9.13 (231.9)‡	10,000
PDL-408-TL	A	Semi-Rigid Vinyl	White	1.95 (49.5)	0.40 (10.2)	—	0.50 (12.7)	1	250•	2.95 (74.9)	1 Roll (250 Labels)
PDL-32-1	B	Vinyl Cloth	White	2.00 (50.8)	0.38 (9.5)	2.10 (53.4)	0.50 (12.7)	4	24	9.30 (236.2)‡	1000
PDL-32	B	Vinyl Cloth	White	2.00 (50.8)	0.38 (9.5)	2.10 (53.4)	0.50 (12.7)	4	24	9.30 (236.2)‡	5000
PDL-32-10	B	Vinyl Cloth	White	2.00 (50.8)	0.38 (9.5)	2.10 (53.4)	0.50 (12.7)	4	24	9.30 (236.2)‡	10,000
PDL-76	B	TEDLAR	White	2.00 (50.8)	0.38 (9.5)	2.10 (53.4)	0.50 (12.7)	4	24	9.30 (236.2)‡	5000
PDL-77	B	Polyester	White	2.00 (50.8)	0.38 (9.5)	2.10 (53.4)	0.50 (12.7)	4	24	9.30 (236.2)‡	5000
PDL-78	B	Destr. Paper	White	2.00 (50.8)	0.38 (9.5)	2.10 (53.4)	0.50 (12.7)	4	24	9.30 (236.2)‡	5000
PDL-110-1	B	TEDLAR	White	2.00 (50.8)	0.38 (9.5)	2.10 (53.4)	0.50 (12.7)	3	24	7.20 (182.9)	1000
PDL-110	B	TEDLAR	White	2.00 (50.8)	0.38 (9.5)	2.10 (53.4)	0.50 (12.7)	3	24	7.20 (182.9)	5000
PDL-111-1	B	Polyester	White	2.00 (50.8)	0.38 (9.5)	2.10 (53.4)	0.50 (12.7)	3	24	7.20 (182.9)	1000
PDL-111	B	Polyester	White	2.00 (50.8)	0.38 (9.5)	2.10 (53.4)	0.50 (12.7)	3	24	7.20 (182.9)	5000
PDL-112	B	Destr. Paper	White	2.00 (50.8)	0.38 (9.5)	2.10 (53.4)	0.50 (12.7)	3	24	7.20 (182.9)	5000
PDL-113	B	Vinyl	White	2.00 (50.8)	0.38 (9.5)	2.10 (53.4)	0.50 (12.7)	3	24	7.20 (182.9)	5000
PDL-114	B	Vinyl Cloth	White	2.00 (50.8)	0.38 (9.5)	2.10 (53.4)	0.50 (12.7)	3	24	7.20 (182.9)	5000
PDL-237	B	Polyimide	Amber	2.00 (50.8)	0.38 (9.5)	2.10 (53.4)	0.50 (12.7)	3	24	7.20 (182.9)	5000
PDL-7517	B	Polyester	Silver	2.00 (50.8)	0.38 (9.5)	2.10 (53.4)	0.50 (12.7)	4	24	9.30 (236.2)‡	5000
PDL110G5	B	Polyester	Clear	2.00 (50.8)	0.38 (9.5)	2.10 (53.4)	0.50 (12.7)	3	24	7.20 (182.9)	5000
PDL-299	B	Remov. Paper	White	2.00 (50.8)	0.90 (22.9)	2.10 (53.4)	1.00 (25.4)	3	12	7.20 (182.9)	1000
PDL-300	B	Destr. Paper	White	2.00 (50.8)	0.90 (22.9)	2.10 (53.4)	1.00 (25.4)	3	12	7.20 (182.9)	1000
PDL-301	B	Polyester	White	2.00 (50.8)	0.90 (22.9)	2.10 (53.4)	1.00 (25.4)	3	12	7.20 (182.9)	1000
PDL-302	B	Polyester	Silver	2.00 (50.8)	0.90 (22.9)	2.10 (53.4)	1.00 (25.4)	3	12	7.20 (182.9)	1000
PDL-145	B	Polyester	Silver	2.00 (50.8)	1.25 (31.8)	—	1.38 (34.9)	1	8	3.00 (76.2)	1000
PDL-146	B	Vinyl	White	2.00 (50.8)	1.25 (31.8)	—	1.38 (34.9)	1	8	3.00 (76.2)	1000
PDL-147	B	Vinyl Cloth	White	2.00 (50.8)	1.25 (31.8)	—	1.38 (34.9)	1	8	3.00 (76.2)	1000
PDL-148	B	Aluminum	Silver	2.00 (50.8)	1.25 (31.8)	—	1.38 (34.9)	1	8	3.00 (76.2)	1000
PDL-149	B	Destr. Paper	White	2.00 (50.8)	1.25 (31.8)	—	1.38 (34.9)	1	8	3.00 (76.2)	1000
PDL-150	B	Polyester	White	2.00 (50.8)	1.25 (31.8)	—	1.38 (34.9)	1	8	3.00 (76.2)	1000

^TEDLAR is the registered trademark of E. I. DuPont Co.

•Indicates label is roll mounted on 3" (76.2 mm) core

‡Wide carriage printer required to print this label

*Order number of labels required in multiples of Std. Pkg. Qty. For roll mounted labels, order number of rolls required in multiples of Std. Pkg. Qty.

PDL Blank Labels by Size (cont.)

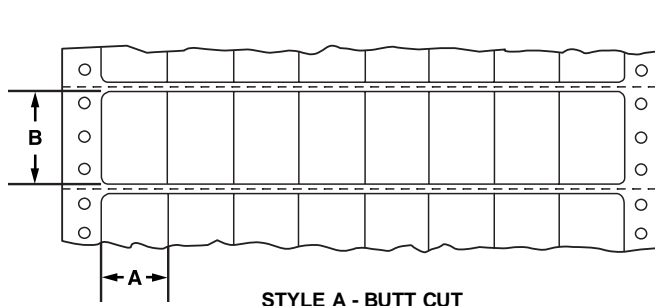

STYLE A - BUTT CUT

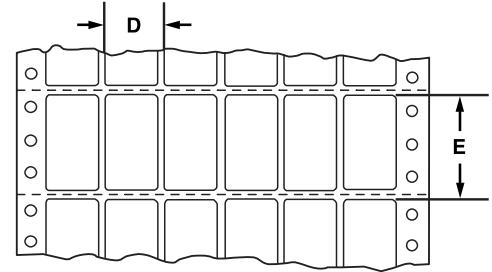

STYLE B - DIE CUT

Part Number	Style	Material	Color	Label Width A In. (mm)	Label Length B In. (mm)	Horizontal Repeat D In. (mm)	Vertical Repeat E In. (mm)	Labels Per Row	Rows Per Fanfold	Web Width F In. (mm)	Std. Pkg. Qty.*
PDL-303	B	Remov. Paper	White	2.00 (50.8)	1.44 (36.5)	2.10 (53.4)	1.50 (38.1)	3	8	7.20 (182.9)	1000
PDL-304	B	Destr. Paper	White	2.00 (50.8)	1.44 (36.5)	2.10 (53.4)	1.50 (38.1)	3	8	7.20 (182.9)	1000
PDL-305	B	Polyester	White	2.00 (50.8)	1.44 (36.5)	2.10 (53.4)	1.50 (38.1)	3	8	7.20 (182.9)	1000
PDL-305-10	B	Polyester	White	2.00 (50.8)	1.44 (36.5)	2.10 (53.4)	1.50 (38.1)	3	8	7.20 (182.9)	10,000
PDL-306	B	Polyester	Silver	2.00 (50.8)	1.44 (36.5)	2.10 (53.4)	1.50 (38.1)	3	8	7.20 (182.9)	1000
PDL-7557-1	B	TEDLAR	White	2.50 (63.5)	4.25 (108.0)	2.75 (69.9)	4.50 (114.3)	4	2	11.89 (302.0)‡	1000
PDL-163	B	Destr. Paper	White	2.80 (71.1)	1.00 (25.4)	2.90 (73.7)	1.13 (28.6)	3	8	9.50 (241.3)‡	1000
PDL-164	B	Vinyl Cloth	White	2.80 (71.1)	1.00 (25.4)	2.90 (73.7)	1.13 (28.6)	3	8	9.50 (241.3)‡	1000
PDL-165	B	Destr. Paper	White	2.80 (71.1)	1.50 (38.1)	2.90 (73.7)	1.63 (41.3)	3	8	9.50 (241.3)‡	1000
PDL-166	B	Vinyl Cloth	White	2.80 (71.1)	1.50 (38.1)	2.90 (73.7)	1.63 (41.3)	3	8	9.50 (241.3)‡	1000
PDL-410-TL	A	Semi-Rigid Vinyl	White	3.00 (76.2)	0.33 (8.5)	—	0.33 (8.5)	1	250•	4.00 (101.6)	1 Roll (250 Labels)
PDL-33	B	Vinyl Cloth	White	3.00 (76.2)	0.38 (9.5)	3.10 (78.7)	0.50 (12.7)	2	24	7.10 (180.3)	5000
PDL-79	B	TEDLAR	White	3.00 (76.2)	0.38 (9.5)	3.10 (78.7)	0.50 (12.7)	2	24	7.10 (180.3)	5000
PDL-80	B	Polyester	White	3.00 (76.2)	0.38 (9.5)	3.10 (78.7)	0.50 (12.7)	2	24	7.10 (180.3)	5000
PDL-81	B	Destr. Paper	White	3.00 (76.2)	0.38 (9.5)	3.10 (78.7)	0.50 (12.7)	2	24	7.10 (180.3)	5000
PDL-232	B	Polyimide	Amber	3.00 (76.2)	0.38 (9.5)	3.10 (78.7)	0.50 (12.7)	2	24	7.10 (180.3)	5000
PDL-307	B	Vinyl Cloth	Yellow	3.00 (76.2)	0.90 (22.9)	3.10 (78.7)	1.00 (25.4)	2	12	7.10 (180.3)	1000
PDL-308	B	Vinyl Cloth	White	3.00 (76.2)	0.90 (22.9)	3.10 (78.7)	1.00 (25.4)	2	12	7.10 (180.3)	1000
PDL-309	B	Remov. Paper	White	3.00 (76.2)	0.90 (22.9)	3.10 (78.7)	1.00 (25.4)	2	12	7.10 (180.3)	1000
PDL-310	B	Destr. Paper	White	3.00 (76.2)	0.90 (22.9)	3.10 (78.7)	1.00 (25.4)	2	12	7.10 (180.3)	1000
PDL-311	B	Polyester	White	3.00 (76.2)	0.90 (22.9)	3.10 (78.7)	1.00 (25.4)	2	12	7.10 (180.3)	1000
PDL-312	B	Polyester	Silver	3.00 (76.2)	0.90 (22.9)	3.10 (78.7)	1.00 (25.4)	2	12	7.10 (180.3)	1000
PDL-313	B	Remov. Paper	White	3.00 (76.2)	1.44 (36.5)	3.10 (78.7)	1.50 (38.1)	2	8	7.10 (180.3)	1000
PDL-314	B	Destr. Paper	White	3.00 (76.2)	1.44 (36.5)	3.10 (78.7)	1.50 (38.1)	2	8	7.10 (180.3)	1000
PDL-315	B	Polyester	White	3.00 (76.2)	1.44 (36.5)	3.10 (78.7)	1.50 (38.1)	2	8	7.10 (180.3)	1000
PDL-316	B	Polyester	Silver	3.00 (76.2)	1.44 (36.5)	3.10 (78.7)	1.50 (38.1)	2	8	7.10 (180.3)	1000
PDL-317	B	Remov. Paper	White	3.00 (76.2)	1.90 (48.3)	3.10 (78.7)	2.00 (50.8)	2	6	7.10 (180.3)	1000
PDL-318	B	Destr. Paper	White	3.00 (76.2)	1.90 (48.3)	3.10 (78.7)	2.00 (50.8)	2	6	7.10 (180.3)	1000
PDL-319	B	Polyester	White	3.00 (76.2)	1.90 (48.3)	3.10 (78.7)	2.00 (50.8)	2	6	7.10 (180.3)	1000
PDL-320	B	Polyester	Silver	3.00 (76.2)	1.90 (48.3)	3.10 (78.7)	2.00 (50.8)	2	6	7.10 (180.3)	1000
PDL-139	B	Polyester	Silver	3.00 (76.2)	2.00 (50.8)	—	3.00 (76.2)	1	4	4.00 (101.6)	1000
PDL-140	B	Vinyl	White	3.00 (76.2)	2.00 (50.8)	—	3.00 (76.2)	1	4	4.00 (101.6)	1000
PDL-141	B	Destr. Paper	White	3.00 (76.2)	2.00 (50.8)	—	3.00 (76.2)	1	4	4.00 (101.6)	1000
PDL-142	B	Vinyl Cloth	White	3.00 (76.2)	2.00 (50.8)	—	3.00 (76.2)	1	4	4.00 (101.6)	1000
PDL-143	B	Aluminum	Silver	3.00 (76.2)	2.00 (50.8)	—	3.00 (76.2)	1	4	4.00 (101.6)	1000
PDL-144	B	Polyester	White	3.00 (76.2)	2.00 (50.8)	—	3.00 (76.2)	1	4	4.00 (101.6)	1000
PDL-151	B	Polyester	Silver	3.25 (82.6)	1.25 (31.8)	—	1.56 (39.7)	1	8	4.25 (108.0)	1000
PDL-152	B	Vinyl	White	3.25 (82.6)	1.25 (31.8)	—	1.56 (39.7)	1	8	4.25 (108.0)	1000
PDL-153	B	Vinyl Cloth	White	3.25 (82.6)	1.25 (31.8)	—	1.56 (39.7)	1	8	4.25 (108.0)	1000
PDL-154	B	Aluminum	Silver	3.25 (82.6)	1.25 (31.8)	—	1.56 (39.7)	1	8	4.25 (108.0)	1000
PDL-155	B	Destr. Paper	White	3.25 (82.6)	1.25 (31.8)	—	1.56 (39.7)	1	8	4.25 (108.0)	1000
PDL-156	B	Polyester	White	3.25 (82.6)	1.25 (31.8)	—	1.56 (39.7)	1	8	4.25 (108.0)	1000

*TEDLAR is the registered trademark of E. I. DuPont Co.

‡Indicates label is roll mounted on 3" (76.2 mm) core

•Order number of labels required in multiples of Std. Pkg. Qty. For roll mounted labels, order number of rolls required in multiples of Std. Pkg. Qty.

Dot-Matrix Labeling Products

PDL Blank Labels by Size (cont.)

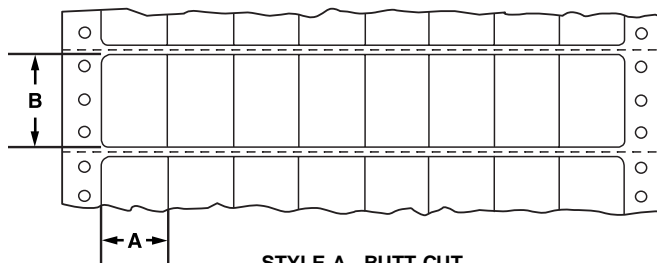

STYLE A - BUTT CUT



STYLE B - DIE CUT

Part Number	Style	Material	Color	Label Width A In. (mm)	Label Length B In. (mm)	Horizontal Repeat D In. (mm)	Vertical Repeat E In. (mm)	Labels Per Row	Rows Per Fanfold	Web Width F In. (mm)	Std. Pkg. Qty.*
PDL-159	B	Destr. Paper	White	3.63 (92.1)	1.00 (25.4)	3.73 (94.6)	1.13 (28.6)	2	8	8.50 (215.9)	5000
PDL-160	B	Vinyl Cloth	White	3.63 (92.1)	1.00 (25.4)	3.73 (94.6)	1.13 (28.6)	2	8	8.50 (215.9)	5000
PDL-161	B	Destr. Paper	White	3.63 (92.1)	1.50 (38.1)	3.73 (94.6)	1.63 (41.3)	2	8	8.50 (215.9)	5000
PDL-162	B	Vinyl Cloth	White	3.63 (92.1)	1.50 (38.1)	3.73 (94.6)	1.63 (41.3)	2	8	8.50 (215.9)	5000
PDL-321	B	Vinyl Cloth	Yellow	3.90 (99.1)	0.90 (22.9)	4.00 (101.6)	1.00 (25.4)	2	12	9.00 (228.6)	1000
PDL-322	B	Vinyl Cloth	White	3.90 (99.1)	0.90 (22.9)	4.00 (101.6)	1.00 (25.4)	2	12	9.00 (228.6)	1000
PDL-323	B	Vinyl Cloth	White	3.90 (99.1)	1.44 (36.5)	4.00 (101.6)	1.50 (38.1)	2	8	9.00 (228.6)	1000
PDL-324	B	Vinyl Cloth	White	3.90 (99.1)	1.44 (36.5)	4.00 (101.6)	1.50 (38.1)	2	8	9.00 (228.6)	1000
PDL-325	B	Remov. Paper	White	3.90 (99.1)	1.44 (36.5)	4.00 (101.6)	1.50 (38.1)	2	8	9.00 (228.6)	1000
PDL-326	B	Destr. Paper	White	3.90 (99.1)	1.44 (36.5)	4.00 (101.6)	1.50 (38.1)	2	8	9.00 (228.6)	1000
PDL-327	B	Polyester	White	3.90 (99.1)	1.44 (36.5)	4.00 (101.6)	1.50 (38.1)	2	8	9.00 (228.6)	1000
PDL-328	B	Polyester	Silver	3.90 (99.1)	1.44 (36.5)	4.00 (101.6)	1.50 (38.1)	2	8	9.00 (228.6)	1000
PDL-329	B	Vinyl Cloth	Yellow	3.90 (99.1)	2.90 (73.7)	4.00 (101.6)	3.00 (76.2)	2	4	9.00 (228.6)	1000
PDL-330	B	Vinyl Cloth	White	3.90 (99.1)	2.90 (73.7)	4.00 (101.6)	3.00 (76.2)	2	4	9.00 (228.6)	1000
PDL-331	B	Vinyl Cloth	Yellow	6.00 (152.4)	0.90 (22.9)	—	1.00 (25.4)	1	12	7.10 (180.3)	1000
PDL-332	B	Vinyl Cloth	White	6.00 (152.4)	0.90 (22.9)	—	1.00 (25.4)	1	12	7.10 (180.3)	1000
PDL-333	B	Vinyl Cloth	Yellow	6.00 (152.4)	1.44 (36.6)	—	1.50 (38.1)	1	8	7.10 (180.3)	1000
PDL-334	B	Vinyl Cloth	White	6.00 (152.4)	1.44 (36.6)	—	1.50 (38.1)	1	8	7.10 (180.3)	1000
PDL-335	B	Vinyl Cloth	Yellow	6.00 (152.4)	1.90 (48.3)	—	2.00 (50.8)	1	6	7.10 (180.3)	1000
PDL-336	B	Vinyl Cloth	White	6.00 (152.4)	1.90 (48.3)	—	2.00 (50.8)	1	6	7.10 (180.3)	1000
PDL-337	B	Vinyl Cloth	Yellow	6.00 (152.4)	2.90 (73.7)	—	3.00 (76.2)	1	4	7.10 (180.3)	1000
PDL-338	B	Vinyl Cloth	White	6.00 (152.4)	2.90 (73.7)	—	3.00 (76.2)	1	4	7.10 (180.3)	1000
PDL-339	B	Remov. Paper	White	6.00 (152.4)	3.94 (100.0)	—	4.00 (101.6)	1	3	7.10 (180.3)	1000
PDL-340	B	Destr. Paper	White	6.00 (152.4)	3.94 (100.0)	—	4.00 (101.6)	1	3	7.10 (180.3)	1000
PDL-403-1	B	Polyester	White	7.50 (190.5)	0.50 (12.7)	—	0.50 (12.7)	1	1000•	8.50 (215.9)	1000
PDL-403-1B	B	Polyester	Blue	7.50 (190.5)	0.50 (12.7)	—	0.50 (12.7)	1	1000•	8.50 (215.9)	1000
PDL-403-1BR	B	Polyester	Brown	7.50 (190.5)	0.50 (12.7)	—	0.50 (12.7)	1	1000•	8.50 (215.9)	1000
PDL-403-1G	B	Polyester	Green	7.50 (190.5)	0.50 (12.7)	—	0.50 (12.7)	1	1000•	8.50 (215.9)	1000
PDL-403-1GR	B	Polyester	Gray	7.50 (190.5)	0.50 (12.7)	—	0.50 (12.7)	1	1000•	8.50 (215.9)	1000
PDL-403-1OR	B	Polyester	Orange	7.50 (190.5)	0.50 (12.7)	—	0.50 (12.7)	1	1000•	8.50 (215.9)	1000
PDL-403-1PR	B	Polyester	Purple	7.50 (190.5)	0.50 (12.7)	—	0.50 (12.7)	1	1000•	8.50 (215.9)	1000
PDL-403-1R	B	Polyester	Red	7.50 (190.5)	0.50 (12.7)	—	0.50 (12.7)	1	1000•	8.50 (215.9)	1000
PDL-403-1Y	B	Polyester	Yellow	7.50 (190.5)	0.50 (12.7)	—	0.50 (12.7)	1	1000•	8.50 (215.9)	1000
PDL-403-2.5	B	Polyester	White	7.50 (190.5)	0.50 (12.7)	—	0.50 (12.7)	1	2500•	8.50 (215.9)	2500
PDL-404-1	B	Polyester	Clear	7.50 (190.5)	0.50 (12.7)	—	0.50 (12.7)	1	1000•	8.50 (215.9)	1000
PDL-404-2.5	B	Polyester	Clear	7.50 (190.5)	0.50 (12.7)	—	0.50 (12.7)	1	2500•	8.50 (215.9)	2500
PDL-341	B	Vinyl Cloth	Yellow	8.00 (203.2)	1.44 (36.5)	—	1.50 (38.1)	1	8	9.00 (228.6)	1000
PDL-342	B	Vinyl Cloth	White	8.00 (203.2)	1.44 (36.5)	—	1.50 (38.1)	1	8	9.00 (228.6)	1000
PDL-343	B	Vinyl Cloth	Yellow	12.00 (304.8)	1.90 (48.3)	—	2.00 (50.8)	1	6	13.00 (330.2)‡	1000
PDL-344	B	Vinyl Cloth	White	12.00 (304.8)	1.90 (48.3)	—	2.00 (50.8)	1	6	13.00 (330.2)‡	1000
PDL-345	B	Vinyl Cloth	Yellow	12.00 (304.8)	2.90 (73.7)	—	3.00 (76.2)	1	4	13.00 (330.2)‡	1000
PDL-346	B	Vinyl Cloth	White	12.00 (304.8)	2.90 (73.7)	—	3.00 (76.2)	1	4	13.00 (330.2)‡	1000

‡Wide carriage printer required to print this label
 •Indicates label is roll mounted on 3" (76.2 mm) core
 *Order number of labels required in multiples of Std. Pkg. Qty.

Heat Shrink Data Label Kits



- System allows the user to prepare, with their own computer, whatever information is required to identify wire or cables up to ½" (12.7 mm) diameter, *without the use of special printers or materials.*
- Provided in every kit are 1000 clear tubes, 1½" (38.1 mm) long and 1000 dot-matrix labels listed below

Selection:

1. Measure outside diameter of wire to be marked or determine the wire gauge
2. Select the part number based on the chart below.
3. Order from your local Panduit distributor
4. Print the label using any Panduit software program
5. Apply label to wire
6. Slip on heat shrink tubing
7. Apply heat from any standard heat gun. Shrink ratio is 2:1

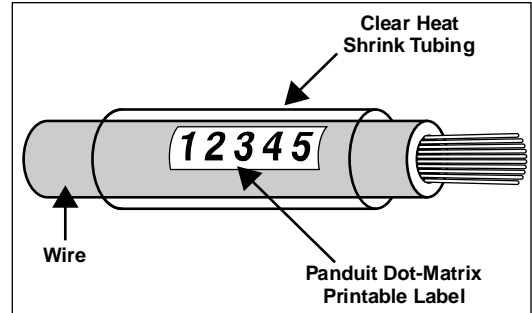

Part Number	Label Size Width x Length In. (mm)	For Wire Range	Kit Contents			
			Heat Shrink Sleeve Minimum Expanded Tubing Inside Diameter In. (mm)	Qty.	Labels Included	Std Pkg. Qty.*
HSDL9-12-94	0.90 x 0.25 (22.9 x 6.3)	16 to 22 AWG	0.13 (3.2)	1000	PDL-94	1000 Kits
HSDL9-12-285	0.90 x 0.25 (22.9 x 6.3)	16 to 22 AWG	0.13 (3.2)	1000	PDL-285	1000 Kits
HSDL9-25-94	0.90 x 0.25 (22.9 x 6.3)	10 to 12 AWG	0.25 (6.3)	1000	PDL-94	1000 Kits
HSDL9-25-285	0.90 x 0.25 (22.9 x 6.3)	10 to 12 AWG	0.25 (6.3)	1000	PDL-285	1000 Kits
HSDL9-37-31	1.00 x 0.38 (25.4 x 9.5)	4 to 10 AWG	0.35 (8.9)	1000	PDL-31	1000 Kits
HSDL9-50-31	1.00 x 0.38 (25.4 x 9.5)	2 to 8 AWG	0.50 (12.7)	1000	PDL-31	1000 Kits
HSDL9-75-20	1.00 x 0.38 (25.4 x 9.5)	4/0 to 3 AWG	0.75 (19.1)	1000	PDL-20	1000 Kits
HSDL9-100-293	1.00 x 0.38 (25.4 x 9.5)	1/0 to 1 AWG	1.00 (25.4)	1000	PDL-293	1000 Kits

□ 14 AWG wire Type THW, use HSDL9-25-94 or -285

□ 14 AWG wire Type THNN, use HSDL9-12-94 or -285

*Order number of label kits required in multiples of Std. Pkg. Qty.

PAN-SHRINK Heat Shrink Tools and Accessories

- For use with all Panduit Heat Shrink Markers
- Other Heat Shrink Tools and replacement parts available. Contact factory for details.



Part Number	Description	Std. Pkg. Qty.*
HSG-115V-500	General Purpose Tool – Air intake regulator varies temperature from 500°F (260°C) to 620°F (344°C), 115 Vdlt, 11 AMP. Neoprene jacketed cord with molded strain relief	1
HSG-115V-300	Low Temperature Tool – For use on small sizes of heat shrink when under or near heat sensitive items. Air intake regulator varies temperature from 300°F (145°C) to 450°F (232°C), 115 Volt, 8 AMP. Neoprene jacketed cord with molded strain relief	1
HSG-A1	Shrink tube reflector for tubing up to 0.75" (19.1 mm) inside diameter – Directs heat around the tubing to reduce shrink time.	1
HSG-A2	Shrink tube reflector for tubing up to 1.50" (38.1 mm) inside diameter – Directs heat around the tubing to reduce shrink time.	1
HSG-A3	Shrink tube concentrator – Directs heat toward tubing and away from heat sensitive items.	1
HSG-A4	Black polyethylene case – Stores heat tool, stand and all three accessories.	1

*Order number of heat shrink accessories required in multiples of Std. Pkg. Qty.

Dot-Matrix Data Plates (PDP) - Introduction

Panduit Data Plates are non-adhesive tags used to mark wires, cables, equipment, inventory and many applications where an adhesive label is not the best solution.

- Choose from 12 different sizes, 3 materials and 2 styles
- Materials offer three different grades of strength and durability
- Can also be marked with Panduit Permanent Marking Pens (see [pg. 101](#))

Suggested Applications for Dot-Matrix Data Plates



Identify wires, cables or equipment requiring removable and reusable information



Tag equipment



Tag large bundles of cables or cables with large diameters



Identify harness board assemblies



Use on cables or wires that are constantly being bent or moved



Use to warn or inform

PDP Data Plate Labels - Drawings and Specifications

Choose the material that best suits your application:

Material Code	Material Type	Temperature Range	Key Features	Color	Outdoor Rated	Hazardous Environment	UL Rec.	CSA
GMH1	Polyester/Polycarbonate	-40°F to 250°F (-40°C to 121°C)	Semi-rigid non-adhesive film with excellent strength properties and flame resistance	White	Yes	Yes	No	No
GMY1	Polyester	-40°F to 185°F (-40°C to 85°C)	Semi-rigid non-adhesive film with excellent strength and durability	White	Yes	Yes	No	No
GMV9	Vinyl	-20°F to 176°F (-29°C to 80°C)	Semi-rigid non-adhesive film for flexible tags with limited tensile strength	White	No	Yes	No	No

PDP Data Plate Labels— Drawings and Specifications

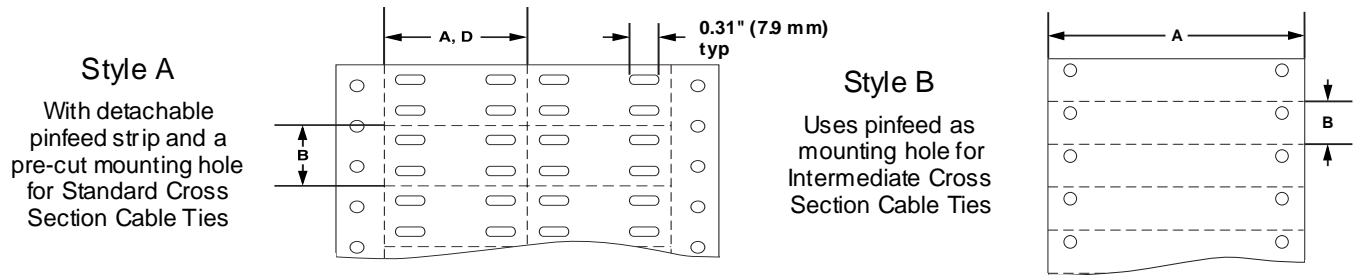

Part Number	Style	Material	Color	Tag Width A In. (mm)	Tag Length † B In. (mm)	Horizontal Repeat D In. (mm)	Labels Per Row	Roll Width In. (mm)	Labels Per Roll	Use with Panduit Cable Tie	Std. Pkg. Qty.*
PDP-3	A	Polyester/Polycarbonate	White	1.50 (38.1)	0.75 (19.1)	1.50 (38.1)	2	4.00 (101.6)	500	PLT•S-L0	1 Roll
PDP-15	A	Polyester	White	1.50 (38.1)	0.75 (19.1)	1.50 (38.1)	2	4.00 (101.6)	500	PLT•S-L0	1 Roll
PDP-27	A	Vinyl	White	1.50 (38.1)	0.75 (19.1)	1.50 (38.1)	2	4.00 (101.6)	500	PLT•S-C	1 Roll
PDP-4	A	Polyester/Polycarbonate	White	1.75 (44.5)	0.75 (19.1)	1.75 (44.5)	2	4.5 (114.3)	500	PLT•S-L0	1 Roll
PDP-16	A	Polyester	White	1.75 (44.5)	0.75 (19.1)	1.75 (44.5)	2	4.5 (114.3)	500	PLT•S-L0	1 Roll
PDP-28	A	Vinyl	White	1.75 (44.5)	0.75 (19.1)	1.75 (44.5)	2	4.5 (114.3)	500	PLT•S-C	1 Roll
PDP-6	A	Polyester/Polycarbonate	White	2.00 (50.8)	0.50 (12.7)	2.00 (50.8)	2	5.00 (127.0)	500	PLT•S-L0	1 Roll
PDP-18	A	Polyester	White	2.00 (50.8)	0.50 (12.7)	2.00 (50.8)	2	5.00 (127.0)	500	PLT•S-L0	1 Roll
PDP-30	A	Vinyl	White	2.00 (50.8)	0.50 (12.7)	2.00 (50.8)	2	5.00 (127.0)	500	PLT•S-C	1 Roll
PDP-5	A	Polyester/Polycarbonate	White	2.00 (50.8)	0.75 (19.1)	2.00 (50.8)	2	5.00 (127.0)	500	PLT•S-L0	1 Roll
PDP-17	A	Polyester	White	2.00 (50.8)	0.75 (19.1)	2.00 (50.8)	2	5.00 (127.0)	500	PLT•S-L0	1 Roll
PDP-29	A	Vinyl	White	2.00 (50.8)	0.75 (19.1)	2.00 (50.8)	2	5.00 (127.0)	500	PLT•S-C	1 Roll
PDP-7	A	Polyester/Polycarbonate	White	2.50 (63.5)	0.75 (19.1)	2.50 (63.5)	2	6.00 (152.4)	500	PLT•S-L0	1 Roll
PDP-19	A	Polyester	White	2.50 (63.5)	0.75 (19.1)	2.50 (63.5)	2	6.00 (152.4)	500	PLT•S-L0	1 Roll
PDP-31	A	Vinyl	White	2.50 (63.5)	0.75 (19.1)	2.50 (63.5)	2	6.00 (152.4)	500	PLT•S-C	1 Roll
PDP-8	B	Polyester/Polycarbonate	White	3.00 (76.2)	0.50 (12.7)	NA	1	3.00 (76.2)	500	PLT•I-C0	1 Roll
PDP-20	B	Polyester	White	3.00 (76.2)	0.50 (12.7)	NA	1	3.00 (76.2)	500	PLT•I-C0	1 Roll
PDP-32	B	Vinyl	White	3.00 (76.2)	0.50 (12.7)	NA	1	3.00 (76.2)	500	PLT•I-C	1 Roll
PDP-9	B	Polyester/Polycarbonate	White	3.00 (76.2)	1.00 (25.4)	NA	1	3.00 (76.2)	500	PLT•I-C0	1 Roll
PDP-21	B	Polyester	White	3.00 (76.2)	1.00 (25.4)	NA	1	3.00 (76.2)	500	PLT•I-C0	1 Roll
PDP-33	B	Vinyl	White	3.00 (76.2)	1.00 (25.4)	NA	1	3.00 (76.2)	500	PLT•I-C	1 Roll
PDP-10	B	Polyester/Polycarbonate	White	3.00 (76.2)	1.50 (38.1)	NA	1	3.00 (76.2)	500	PLT•I-C0	1 Roll
PDP-22	B	Polyester	White	3.00 (76.2)	1.50 (38.1)	NA	1	3.00 (76.2)	500	PLT•I-C0	1 Roll
PDP-34	B	Vinyl	White	3.00 (76.2)	1.50 (38.1)	NA	1	3.00 (76.2)	500	PLT•I-C	1 Roll
PDP-11	B	Polyester/Polycarbonate	White	3.00 (76.2)	2.00 (50.8)	NA	1	3.00 (76.2)	500	PLT•I-C0	1 Roll
PDP-23	B	Polyester	White	3.00 (76.2)	2.00 (50.8)	NA	1	3.00 (76.2)	500	PLT•I-C0	1 Roll
PDP-35	B	Vinyl	White	3.00 (76.2)	2.00 (50.8)	NA	1	3.00 (76.2)	500	PLT•I-C	1 Roll
PDP-12	B	Polyester/Polycarbonate	White	3.50 (88.9)	2.50 (63.5)	NA	1	3.50 (88.9)	500	PLT•I-C0	1 Roll
PDP-24	B	Polyester	White	3.50 (88.9)	2.50 (63.5)	NA	1	3.50 (88.9)	500	PLT•I-C0	1 Roll
PDP-36	B	Vinyl	White	3.50 (88.9)	2.50 (63.5)	NA	1	3.50 (88.9)	500	PLT•I-C	1 Roll
PDP-1	A	Polyester/Polycarbonate	White	4.00 (101.6)	0.75 (19.1)	NA	1	5.00 (127.0)	500	PLT•S-L0	1 Roll
PDP-13	A	Polyester	White	4.00 (101.6)	0.75 (19.1)	NA	1	5.00 (127.0)	500	PLT•S-L0	1 Roll
PDP-25	A	Vinyl	White	4.00 (101.6)	0.75 (19.1)	NA	1	5.00 (127.0)	500	PLT•S-C	1 Roll
PDP-2	A	Polyester/Polycarbonate	White	4.00 (101.6)	1.50 (38.1)	NA	1	5.00 (127.0)	500	PLT•S-L0	1 Roll
PDP-14	A	Polyester	White	4.00 (101.6)	1.50 (38.1)	NA	1	5.00 (127.0)	500	PLT•S-L0	1 Roll
PDP-26	A	Vinyl	White	4.00 (101.6)	1.50 (38.1)	NA	1	5.00 (127.0)	500	PLT•S-C	1 Roll

† Tag length equals vertical repeat
 * Indicates any length tie can be used. Also, Flame Retardant Ties can be substituted.
 * Order number of rolls required in multiples of Std. Pkg. Qty.

Dot-Matrix Indelible Ink Ribbons (PDLR) - Introduction



Panduit Data Label Ribbons are designed to give you the security of knowing that your printed legend will not fade over a short period of time. The aggressive ink is designed for use on non-porous materials to eliminate smearing and on any material that is subjected to UV rays.

PDLR's are quick drying, abrasion resistant and have excellent UV resistance. Drying speed of ink will vary depending on the material top coating and the amount of ink put on the surface. PDLR's will dry on most surfaces within 5 to 30 minutes.

Suggested Applications for Dot-Matrix Indelible Ink Ribbons



Use in high temperature applications such as Electronics Labeling



Immediately apply self-laminating labels



Security concerns



Outdoor applications



Permanently tag



Identify in harsh environments or where chemical resistance is a factor

Indelible Ink Ribbons by Printer Model

- Choose from over 59 ribbons which accommodate over 300 different printer models
- Panduit can also supply custom ribbons for printers not shown. Contact factory for details.

Printer—Model	Part Number
A	
APPLE A9-M0310 AT T 473	PDLR-1
B	
BRADY WRITER B2	PDLR-5
BROTHER HR15 BROTHER HR20 BROTHER HR25	PDLR-7
BROTHER M1509 BROTHER M1709	PDLR-6
BURROUGHS 800/L9000	PDLR-9
C	
CENTRONIX 100/101/102/103	PDLR-9
CENTRONIX H136A/H80136	PDLR-10
CITIZEN 120D CITIZEN 180D CITIZEN GSX-140	PDLR-12
CITIZEN MPS10 CITIZEN MST10 CITIZEN MST40	PDLR-13
CITIZEN MSP15	PDLR-17
CITOH PC 8020A CITOH PC 1550 CITOH PC 8510 CITOH PC 8500	PDLR-1
COMMODORE MPP1361	PDLR-37
COMREX 420	PDLR-317
D	
DEC 3 (DECWRITER III) DEC LA 120/180 DEC LS 120/180	PDLR-41
DEC LA30/36 (DECWRITER) DEC LA 35/40/80	PDLR-45
DEC LA34/38/100/200 DEC 4 (DECWRITER IV)	PDLR-57
DIABLO (HYTYPE II)	PDLR-61
DIABLO S-11	PDLR-65
E	
EPSON 3210 EPSON FX70/80/82/85/86/86E EPSON FX800/850/870 EPSON LX300 EPSON MX/RX 70/80/82/85/86/86E EPSON GX80 ER C-08	PDLR-13
EPSON 8755 EPSON EX100/LX100 EPSON MX100/PX100/RX100 EPSON FX100/FX105/FX185 EPSON RX286E/286 EPSON FX1000/FX1050 EPSON FX1170	PDLR-17
EPSON EX800/1000	PDLR-81
EPSON LQ1000/1010/1050 EPSON LQ 1070/1170	PDLR-109
EPSON LQ1000/LQ1050 SILVER	PDLR-109S
EPSON LQ1000/LQ1050 WHITE	PDLR-109W
EPSON LQ500/570+ EPSON LQ800/850/870	PDLR-113

Printer—Model	Part Number
E (cont.)	
EPSON LX80/86/90 EPSON HOMEWRITER 10 EPSON SPECTRUM LX80/90	PDLR-117
EPSON LQ950	PDLR-130
EPSON LQ2500/2550	PDLR-134
EPSON LQ1500	PDLR-135
F	
FACIT 3100	PDLR-1
FACIT 1299095 FACIT 1850 FACIT 86HY	PDLR-133
FACIT 4510/4511	PDLR-141
FACIT 4512/4512-B FACIT 2301/4514	PDLR-145
G	
GRAPHIC 5152-002	PDLR-13
H	
HEWLETT PACKARD 82-906A HEWLETT PACKARD 92156	PDLR-13
I	
INTACS 4200	PDLR-45
IBM 5152	PDLR-13
IBM SELECTRIC II	PDLR-133
IBM PROPRINTER 4202/4208-24 IBM PROPRINTER XL24/XL24E	PDLR-161
IBM3262/A1/B1 IBM5262 SYSTEM 38	PDLR-165
IBM3131 IBM3715 IBM4376-Q1L IBM3281-C1,3287 IBM3621/45	PDLR-169
IBM 3770/72/76/90 (HARMONICA) IBM 3200/3289 IBM 4715/4972/4973	PDLR-170
IBM PROPRINTER 4201 IBM PROPRINTER 4207-24 IBM PROPRINTER X24/X24E	PDLR-173
IBM 4202 XL PROPRINTER	PDLR-177
IBM 4224 MOD IE2/101/102	PDLR-181
IBM 5211	PDLR-189
IBM 5250	PDLR-190
IBM PROPRINTER 4201	PDLR-193
IBM SEL. III 210 BICYCLE	PDLR-205
M	
MANNESMAN 786 6N529-0	PDLR-45
MANNESMAN TALLY 1000	PDLR-65
MANNESMAN TALLY 85 MANNESMAN TALLY 87	PDLR-206
MANNESMAN TALLY 86 MANNESMAN TALLY 88	PDLR-207
MANNESMAN TALLY 100 MANNESMAN TALLY 110 MANNESMAN TALLY 160L	PDLR-212

Indelible Ink Ribbons by Printer Model (cont.)

Printer—Model	Part Number
M (cont.)	
MANNESMAN TALLY 290 MANNESMAN TALLY 130/140/180L	PDLR-215
MANNESMAN TALLY MT230/MT330	PDLR-338
MM TALLY 1000 (SMALL MOUTH)	PDLR-225
MITSUBISHI DX 180W	PDLR-17
N	
NEC 8023A/8023A	PDLR-1
NEC 2200P2200	PDLR-233
NEC 5200/5300/6300 P6+/P9300	PDLR-237
NEC PIN WRITER 1/2/6 (80 COLUMN)	PDLR-249
NEC PIN WRITER 3/7 (136 COLUMN)	PDLR-253
NEC PIN WRITER P5/XL/560/565 NEC PIN WRITER 9/960/965	PDLR-257
O	
OKIDATA 292	PDLR-5
OKIDATA 172/182/183 OKIDATA 192/193 OKIDATA 320/321	PDLR-261
OKIDATA 293/294	PDLR-273
OKIDATA 380/390 OKIDATA 391/391 PLUS	PDLR-279
OKIDATA 80A/82A/83A OKIDATA 92/93	PDLR-281
OKIDATA 393/393 PLUS	PDLR-282
OKIDATA 84/94	PDLR-285
OLYMPIA NP136	PDLR-17
OLMETTI ET 225	PDLR-287
P	
PANASONIC KXP 1080/1081 PANASONIC KXP 1080i	PDLR-292
PANASONIC KXP 1090/1091/1092 PANASONIC KXP 2023	PDLR-293
PANASONIC KXP 1123/1124	PDLR-297
PANASONIC KXP 1150 PANASONIC KXP 1180 PANASONIC KXP 1190/1191	PDLR-298
PANASONIC KXP 1592 PANASONIC KXP 1593 PANASONIC KXP 1595	PDLR-301
PANASONIC KXP 1524/1540 PANASONIC KXP 1624 PANASONIC KXP 2624	PDLR-302
PRINTRONIX P150 PRINTRONIX P300 PRINTRONIX P600	PDLR-305
R	
REMINGTON ELECTRIC 101	PDLR-133
S	
SATA M-4500	PDLR-45
SEKOSHA 5420	PDLR-317
SIEMENS PT-88	PDLR-13
STAR SG10	PDLR-281
STAR DP834	PDLR-337
STAR MICRONICS NB 24-15 STAR MICRONICS NB 15/24	PDLR-330
STAR MICRONICS LC10 STAR MICRONICS NX 1000	PDLR-325
STAR MICRONICS NL10 STAR MICRONICS NB 24-10 STAR MICRONICS NX10/ND10	PDLR-329
STAR MICRONICS SD-15	PDLR-336

Printer—Model	Part Number
T	
TECH3	PDLR-133
TOSHIBA P1340/1350/1360 TOSHIBA P321/341/351	PDLR-333
X	
XEROX 1750	PDLR-61

Computer Printable Labels Used With PANDUIT Marker Ties and Marker Plates



- Marker ties fasten and identify all types of wire and cable bundles at the same time
- Standard label sizes fit Panduit Marker Ties and Marker Plates for easy installation and identification
- Label, tie and marker materials available for indoor/outdoor applications



MARKER TIES - Nylon 6.6 (Indoor Use)†

Part Number	Marker Type	Marking Area Size Width x Length In. (mm)	Length In. (mm)	Width In. (mm)	Maximum Bundle Diameter In. (mm)	Std. Pkg. Qty.*
PLM1M-C	Wrap	0.26 x 0.95 (6.6 x 24.1)	3.9 (99)	0.10 (2.5)	0.75 (19.1)	100
PLM2M-C	Wrap	0.26 x 0.95 (6.6 x 24.1)	8.0 (203)	0.10 (2.5)	2.00 (50.8)	100
PLF1M-C	Flag	0.75 x 0.31 (19.1 x 7.9)	4.3 (109)	0.10 (2.5)	0.87 (22.1)	100
PLF1MA-C	Flag	0.76 x 1.04 (19.3 x 26.4)	5.1 (130)	0.10 (2.5)	0.87 (22.1)	100
PLF1MB-C	Flag	0.92 x 0.31 (23.4 x 7.9)	4.0 (102)	0.10 (2.5)	0.75 (19.1)	100
PLM2S-C	Wrap	0.44 x 0.87 (11.2 x 22.1)	7.4 (188)	0.19 (4.8)	1.75 (44.5)	100
PLM4S-C	Wrap	0.44 x 2.00 (11.2 x 50.8)	14.6 (371)	0.19 (4.8)	4.00 (101.6)	100
PL2M2S-L	Wrap	0.87 x 1.07 (22.1 x 27.2)	7.4 (188)	0.19 (4.8)	1.75 (44.5)	50
PL3M2S-L	Wrap	0.87 x 1.79 (22.1 x 45.5)	7.4 (188)	0.19 (4.8)	1.75 (44.5)	50

*Order number of ties required in multiples of Standard Package Quantity.
†For Weather Resistant Black Nylon 6.6, add suffix "0". Example: PLM1M-C0.

MARKER PLATES - Nylon 6.6 (Indoor Use)†

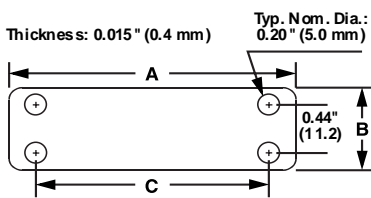

Part Number	Use With Cable Ties	Dimensions Inches (mm)			Std. Pkg. Qty.*
		A	B	C	
MP150-C	M, I, S	1.50 (38.1)	0.75 (19.1)	1.03 (26.2)	100
MP175-C		1.75 (44.5)	0.75 (19.1)	1.28 (32.5)	100
MP200-C		2.00 (50.8)	0.75 (19.1)	1.53 (38.4)	100
MP250-C		2.50 (63.5)	0.75 (19.1)	2.03 (51.6)	100
MP350-C		3.50 (88.9)	0.75 (19.1)	3.03 (77.0)	100
MP250W175-C		2.50 (63.5)	1.75 (44.5)	2.03 (51.6)	100

*Order number of marker plates required in multiples of Standard Package Quantity.
†For Weather Resistant Black Nylon 6.6, add suffix "0". Example: MP150-C0.

For more information on the complete line of Panduit Cable Ties and Marker Plates, request the full line Cable Ties and Wiring Accessories Catalog.

Marker Ties and Marker Plates used with Computer Printable Labels (cont.)

- PDL & PLL labels are used with Marker Ties and Marker Plates
- PDL (for Dot-Matrix printers)
- PLL (For Laser Printers)
- PLL label material is good for indoor and outdoor use. Recommended if you need excellent resolution.

TIE or PLATE Part No.	MATERIAL SELECTION ■ Label Part No. Prefix (PDL-)				LASER (PLL-)	LABEL SIZE Width x Length In. (mm)	Labels Per Row	Labels Per Fanfold	Std. Pkg. Qty.*
	GMP1	GMC	GMY	GMT	GMY2				
PLM1M	92	93	94	49		0.90 x 0.25 (22.9 x 6.3)	8	36	5000
PLM2M			285	284		0.90 x 0.25 (22.9 x 6.3)	8	32	5000
PLF1MA					5-Y2-10	0.80 x 0.25 (20.3 x 6.3)	10	39	10,000
PLF1MB	92	93	94	49		0.90 x 0.25 (22.9 x 6.3)	8	36	5000
SSM2S-C		257		259		0.30 x 0.94 (7.6 x 23.8)	16	12	5000
SSM4S-C		357		259		0.30 x 0.94 (7.6 x 23.8)	16	12	5000
PLF1M	85	37	39	84		0.75 x 0.25 (19.1 x 6.3)	9	36	5000
PLM2S		270	274			0.75 x 0.25 (19.1 x 6.3)	9	32	5000
					4-Y2-10	0.65 x 0.25 (16.5 x 6.3)	10	39	10,000
PLF1MA	122	119	121	120		0.50 x 0.25 (12.7 x 6.3)	12	12	5000
MP150		265		267		0.50 x 0.94 (12.7 x 23.8)	16	12	5000
MP175					9-Y2-10	1.00 x 0.50 (25.4 x 12.7)	7	19	10,000
PLM2S		254		256		0.30 x 0.75 (7.6 x 19.1)	16	12	5000
					5-Y2-10	0.80 x 0.25 (20.3 x 6.3)	8	39	10,000
PLM4S	112	114	111	110		2.00 x 0.38 (50.8 x 9.5)	3	24	5000
		257		259		0.30 x 0.94 (7.6 x 23.8)	16	12	5000
					16-Y2-5	1.88 x 0.38 (47.7 x 9.5)	4	25	5000
PL2M2S		19	20	99		1.00 x 0.50 (25.4 x 12.7)	7	18	5000
		288		290		1.00 x 0.75 (25.4 x 19.1)	7	12	5000
		280		282		0.80 x 0.94 (20.3 x 23.8)	10	12	5000
					9-Y2-10	1.00 x 0.50 (25.4 x 12.7)	7	19	10,000
PL3M2S	73	72	27	231		1.50 x 0.75 (38.1 x 19.1)	4	12	5000
		9		10		0.80 x 1.44 (20.3 x 36.5)	6	8	5000
					9-Y2-10	1.00 x 0.50 (25.4 x 12.7)	7	19	10,000
MP150	174		172			0.80 x 0.50 (20.3 x 12.7)	10	16	5000
MP175		288		290		1.00 x 0.75 (25.4 x 19.1)	7	12	5000
MP200					9-Y2-10	1.00 x 0.50 (25.4 x 12.7)	7	19	10,000
MP250	73	72	27	231		1.50 x 0.75 (38.1 x 19.1)	4	12	5000
MP350	112	114	111	110		2.00 x 0.38 (50.8 x 9.5)	3	24	5000
					16-Y2-5	1.88 x 0.38 (47.7 x 9.5)	4	25	5000
MP250W175	73	72	27	231		1.50 x 0.75 (38.1 x 19.1)	4	12	5000
		298				1.50 x 0.90 (38.1 x 22.9)	4	12	5000
					17-Y2-2.5	1.88 x 0.83 (47.7 x 21.1)	4	11	2500
					18-Y2-1.5	1.88 x 1.33 (47.7 x 33.8)	4	7	1500

■ See material selection chart on page 84
 *Order number of labels required in multiples of Std. Pkg. Qty.

Wire Marking Products

Selection of Styles



Marker Books

Pages 132 to 137

Convenient, pocket sized books are an economical, handy way to use wire and identification markers. The book cover keeps the markers fresh and provides part number for re-ordering. Flexible release coated backing for easy marker removal.



Marker Cards

Pages 138 to 147

Choose from the many legends available in general purpose vinyl cloth, or from special materials available to meet a variety of application environments. All of the markers are offered in full size-1.50" (38.1 mm) long for wire outside diameter up to 0.38" (9.5 mm); half size markers for wire outside diameter up to 0.19" (4.7 mm) can be ordered.



Marker Tape

Page 148

Handy dispensers allow tape to be cut quickly and cleanly to any length for different wire or cable diameters. The tape is laminated to insure lasting legibility and resistance to abrasion, oil, water, grease and solvents. Refill rolls are available in a variety of legends.



Self-Laminating Write-On Markers

Page 148

Durable dispenser filled with self-laminating write-on markers. Markers are protected inside dispenser. Markers are available in two sizes for wire outside diameter up to 0.69" (17.5 mm). Refill rolls load easily into reusable dispenser.



Slip-On Markers

Page 149

Panduit slip-on markers provide convenient, permanent identification for wire marking applications. Durable and easy to install, slip-on's expand to double their inside diameter and accommodate a wide range of wire marker diameters (5 sizes from 22AWG to 350MCM), reducing wire marker inventory.



Clip-On Markers

Page 150

Clip-on markers provide the fastest, most convenient, high visibility identification of wires, cables and tubing. All markers are supplied on a handy application wand which speeds installation. Several sizes are available for bundle diameters 0.08" (1.9 mm) through 0.62" (15.7 mm).

Wire Marker Material Selection Guide

Material Code	Material Type	Temperature Range	Key Features	Color	Outdoor Rated	Hazardous Environment	UL Rec	CSA
GMA1	Aluminum	-40°F to 300°F (-40°C to 149°C)	Dead soft aluminum foil wraps easily around wire. Resistant to solvents, oil, heat and abrasion.	Matte Silver	Yes	Yes	No	No
GMAC	Acetate Cloth	-30°F to 220°F (-34°C to 105°C)	Has less discoloration at high temperatures than most materials; good material for varnish dip or baking cycles	White	No	No	No	No
GMACT	Acetal (Non-Adhesive)	-22°F to 194°F (-30°C to 90°C)	Clip-On Wire Marker Material is very strong and has excellent resiliency; good resistance to oils and solvents	White Yellow	No	Yes	No	No
GMC1	Vinyl Cloth	-50°F to 170°F (-46°C to 77°C)	General purpose wire marker material; resists oil and abrasion; can be removed and reused	White Yellow	No	No	No	No
GMM1	Polyester Film	-40°F to 275°F (-40°C to 135°C)	Thin, flexible material produces low profile marker. Resistant to oil, dirt heat and abrasion	White	Yes	Yes	No	No
GMP1	Destructible Paper	-65°F to 200°F (-54°C to 93°C)	Litho paper with destructible adhesive for permanent applications	White	No	No	No	No
GMT	TEDLAR [▲]	-40°F to 275°F (-40°C to 135°C)	Self-extinguishing film for high quality indoor/outdoor, high temperature labels	White	Yes	Yes	Yes	Yes
GMV1	Vinyl Film	-40°F to 176°F (-40°C to 80°C)	General purpose vinyl film	White	Yes (2 yrs.)	No	No	No
GMV3	Self-Laminating Vinyl	-40°F to 150°F (-40°C to 66°C)	Preferred material for most general wire and cable labeling; thin, conformable material	Clear w/ White Print-On Area	No	No	Yes	Yes
GMV11	Vinyl Extrusion (Non-Adhesive)	-8°F to 177°F (-22°C to 80°C)	Slip-On Wire Marker Material is flexible material; good for harsh environments	White Yellow	Yes	Yes	No	No
GMY	Polyester	-40°F to 311°F (-40°C to 154°C)	Provides durability, high temperature resistance, and dimensional stability	White	Yes	Yes	Yes	Yes

[▲]TEDLAR is the registered trademark of E. I. DuPont Co.

Marker Books

Pre-Assembled Books

Material: GMC1 Vinyl Cloth

- Available with white and yellow backgrounds
- Each marker is perforated to form half markers

Marker Type	Marker Size In. (mm)	For Max. Wire O.D.
Full	0.22 x 1.38 (5.6 x 34.9)	0.38 (9.5)
Half	0.22 x 0.69 (5.6 x 17.4)	0.19 (4.7)
Terminal Block	0.22 x 0.25 (5.6 x 6.3)	—

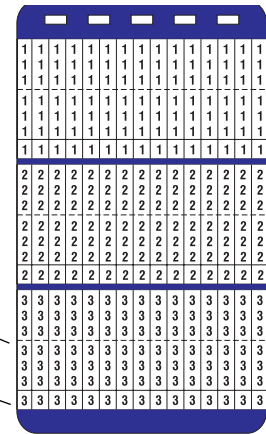

Perforation for half marker
Terminal Block Marker



Markers can be used as temporary flag markers



Markers can be torn in half at perforation to mark both ends of conductor



Terminal Block Marker is provided to permanently identify terminal connections

Black Legend on White Part Number	Black Legend on Yellow Part Number	Legend	Number of Markers Each Legend	Pages Per Book	Std. Pkg. Qty.*	Std. Ctn. Qty.
PCMB-1	PCYMB-1	0 thru 9	45	10 Pgs.	1 Book	10 Books
PCMB-2	PCYMB-2	A thru Z, 0 thru 15, +, -, /	10			
PCMB-3	PCYMB-3	1 thru 45	10			
PCMB-4	PCYMB-4	1, 2, 3	150			
PCMB-5	PCYMB-5	A, B, C	150			
PCMB-6	PCYMB-6	T1, T2, T3	150			
PCMB-7	PCYMB-7	L1, L2, L3	150			
PCMB-8	PCYMB-8	1 thru 15	6			
		16 thru 90	4			
		A thru Z, +, -, /, 0	2			
PCMB-9	PCYMB-9	1, 2, 3, A, B, C	45			
		L1, L2, L3, T1, T2, T3	30			
PCMB-10	—	Solid NEMA colors: red, yellow, white, light blue, light green, black, brown, orange, gray, dark green	45 each color			
PCMB-11	—	1 thru 30	15			
PCMB-12	—	A thru Z	15			
		+	8			
		-	7			
		Blank (write on)	21			
PCMB-13	—	+, -, AC, DC	45			
		POS, NEG, GND	33			
		NEUT	27			
		SPARE, Blank (write-on)	21			
PCMB-14	—	46 thru 90	10			
PCMB-15	—	0 thru 45, +, -	10			
PCMB-16	—	0 thru 33, A, B, C, +, -	10			
		L1, L2, L3, T1, T2, T3	10			
PCMB-25	—	0 thru 9	45			
		L1, L2, L3, T1, T2, T3	15			

*Order number of books required in multiples of Std. Pkg. Qty.; Std. Ctn. is for order convenience.

Marker Books (cont.)

Replacement Pages
(for marker books or index files)
Material: GMC1 Vinyl Cloth



Replacement pages can be used in OEM applications and held in typical "roll-over" index card holders



Convenient replacement pages offer versatility for applications that require a variety of different identification requirements

Marker Type	Marker Size In. (mm)	For Max. Wire O.D.
Full	0.22 x 1.38 (5.6 x 34.9)	0.38 (9.5)
Half	0.22 x 0.69 (5.6 x 17.4)	0.19 (4.7)
Terminal Block	0.22 x 0.25 (5.6 x 6.3)	—



Perforation to form half markers

Terminal Block Marker

Sturdy rigid liner stands up firmly index card holder

Part Number	Legend	Number of Markers Each Legend	Pages Per Book	Std. Pkg. Qty.*	Std. Ctn. Qty.
Numbers					
PCMBR-0 PCMBR-1 thru PCMBR-99	0 1 thru 99	450	10 Pgs.	1 Book	10 Books
PCMBR-100	100	330			
PCMBR-0-9 PCMBR-10-19 thru PCMBR-90-99	0 thru 9 10 thru 19 (one full page of each legend) thru 90 thru 99	45			
PCMBR-100-109 thru PCMBR-190-199	100 thru 109 thru (one full page of each legend) 190 thru 199	33			
Letters					
PCMBR-A thru PCMBR-Z	A thru Z	450	10 Pgs.	1 Book	10 Books
PCMBR-A-Z	A thru Z, /, +, -, 0 thru 15	10			
Symbols					
PCMBR-T1-T3	T1, T2, T3	150	10 Pgs.	1 Book	10 Books
PCMBR-L1-L3	L1, L2, L3	150			
PCMBR-PLS	+	450			
PCMBR-MIN	-	450			

Legend: Black Background: White
*Order number of books required in multiples of Std. Pkg. Qty.; Std. Ctn. is for order convenience.

Marker Books (cont.)

Pre-Assembled Self-Laminating Books Material: GMV3 Self-Laminating Vinyl



- Self-laminate protects the legend against water, grease or solvents
- Provides quick, clear identification of wires or cables
- Marker Size: 0.22" x 1.38" (5.6 mm x 34.9 mm)

0	N	M	L	K	J	I	H	G	F	E	D	C	B	A					
0	N	M	L	K	J	I	H	G	F	E	D	C	B	A					
0	N	M	L	K	J	I	H	G	F	E	D	C	B	A					
0	-	+	/	Z	Y	X	W	V	U	T	S	R	Q	P					
0	-	+	/	Z	Y	X	W	V	U	T	S	R	Q	P					
0	-	+	/	Z	Y	X	W	V	U	T	S	R	Q	P					
15	14	13	12	11	10	9	8	7	6	5	4	3	2	1					
15	14	13	12	11	10	9	8	7	6	5	4	3	2	1					
15	14	13	12	11	10	9	8	7	6	5	4	3	2	1					

Part Number	Legend	Number of Markers Each Legend	Marker Size Width x Length In. (mm)	For Max. Wire O.D. In. (mm)	Pages Per Book	Std. Pkg. Qty.*	Std. Ctn. Qty.
PLMA1	0 thru 9	45	0.22 x 1.56 (5.6 x 39.7)	0.19 (4.7)	10 Pgs.	1 Book	10 Books
PLMA2	A thru Z, 0 thru 15, +, -, /	10					
PLMA3	1 thru 45	10					
PLMA4	1, 2, 3	150					
PLMA5	A, B, C	150					
PLMA6	T1, T2, T3	150					
PLMA8	1 thru 15	6					
	16 thru 90	4					
	A thru Z, +, -, /, 0	2					
PLMA9	1, 2, 3, A, B, C	45					
	L1, L2, L3, T1, T2, T3	30					
PLMA11	1 thru 30	15					
PLMA12	A thru Z	15					
	+	8					
	-	7					
	Blank (write on)	21					
PLMA13	+, -, AC, DC	45					
	POS, NEG, GND	33					
	NEUT	27					
	SPARE, Blank (write-on)	21					
PLMA14	46 thru 90	10					
PLMA15	0 thru 45, +, -	10					
PLMA16	0 thru 33, A, B, C, +, -	10					
	L1, L2, L3, T1, T2, T3	10					

*Order number of books required in multiples of Std. Pkg. Qty.; Std. Ctn. is for order convenience.

Load Center Markers

Used to Identify Circuits on Residential Breaker Panels

Material: GMC1 Vinyl Cloth



Marker Size: 1.41" x 0.75"
(35.8 mm x 19.0 mm)

Part Number	Legend	Total Markers Each Legend	Pages Per Book	Std. Pkg. Qty.*	Std. Ctn. Qty.
PCMB-LC	(2) each/page: Main, Oven, D. Washer, S. Pump, W. Pump, Kitchen, Fam. Rm., Mn. Bath, Mr. Bath, Pwd. Rm., Mr. B'rm., B'rm. 2, B'rm. 3, B'rm. 4, Utl. Rm., Range, Dryer, Disposal, Heating, Air. Cond., Garage, Din. Rm., Liv. Rm.	20	5 pgs.	1 Book	10 Books

Black legend on white background

*Order number of books required in multiples of Std. Pkg. Qty.; Std. Ctn. Qty. is for order convenience

Marker Books (cont.)

Blank Self-Laminating Write-On Cable Marker Books

Material: GMV3 Self-Laminating Vinyl



Blank write-on area available in a variety of sizes and colors



Quick, clear identification of wires or cable

Mark write-on area using Panduit fast-drying, non-smear, marking pens found on [page 137](#)

Self laminate protects the legend against water, grease, oil or solvents

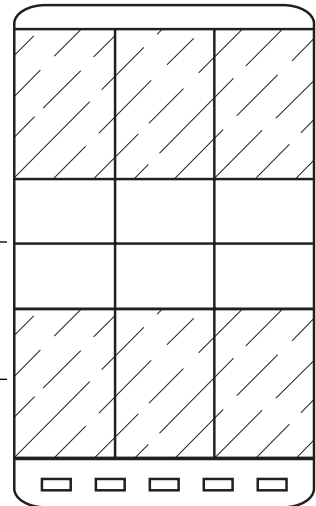

Part Number	Write-On Area Color	Write-On Area Size Width x Length In. (mm)	Total Marker Size Width x Length In. (mm)	For Maximum Wire O.D. In. (mm)	Total Markers per Page	Pages Per Book	Std. Pkg. Qty.*	Std. Ctn. Qty.
PSCB-12	White	1.00 x 0.75 (25.4 x 19.1)	1.00 x 3.00 (25.4 x 76.2)	0.69 (17.5)	6	10 pgs.	1 Book	10 Books
PSCB-3	White							
PSCB-3BLK	Black							
PSCB-3BLU	Blue							
PSCB-3GRN	Green							
PSCB-3RED	Red							
PSCB-3YEL	Yellow							
PSCB-3C	2 Pages Each: Black, Blue, Green, Red, Yellow							
PSCB-13	White	1.50 x 0.75 (38.1 x 19.1)	1.50 x 3.00 (38.1 x 76.2)	0.69 (17.5)	4			
PSCB-5	White	1.00 x 1.00 (25.4 x 25.4)	1.00 x 5.00 (25.4 x 127.0)	1.25 (31.7)	3			
PSCB-6	White	1.00 x 1.00 (25.4 x 25.4)	1.00 x 6.00 (25.4 x 152.4)	1.56 (39.7)	3			
PSCB-6BLU	Blue							
PSCB-6GRN	Green							
PSCB-6RED	Red							
PSCB-6YEL	Yellow							
PSCB-6C	2 Pages Each: Black, Blue, Green, Red, Yellow							
PSCB-16	White	1.50 x 1.00 (38.1 x 25.4)	1.50 x 6.00 (38.1 x 152.4)	1.56 (39.7)	2			

*Order number of books required in multiples of Std. Pkg. Qty.; Std. Ctn. Qty. is for order convenience

Other Self-Laminating Wire Markers available: Thermal Transfer ([pg. 36](#)), Laser ([pgs. 60-61](#)), Dot-Matrix ([pgs. 85-87](#)), Card ([pg. 146](#)), Dispenser ([pg. 148](#))

Network Systems Marker Books

Identify wires, cables and outlets for telephone, computer or peripheral connections

Material: GMY Polyester



MINI-JACK™ Labels



Available in 2 styles:

- Wrap-Around



- Standard



Wrap-Around Label Marker Books

Black on Clear Part Numbers	Legend	Total Markers Each Legend (Book)	Size Width x Length In. (mm)	Std. Pkg. Qty.*
PJIBM-COM	VOICE, DATA, FAX	248/248/124	1.38 x 0.19 (34.9 x 4.8)	1 Book (10 pages)
PJIBM-V	VOICE	620		
PJIBM-D	DATA	620		
PJIBM-DEC	DEC	620		
PJIBM-LAN	LAN	620		
PJIBM-BLNK	(blank)	620		
PJIBM-COMS		248/248/124		
PJIBM-VS		620		
PJIBM-DS		620		

*Order number of books required in multiples of Std. Pkg. Qty.

Standard Label Marker Books

Black on Clear Part Numbers	White on Clear Part Numbers	Legend	Total Markers Each Legend (Book)	Size Width x Length In. (mm)	Std. Pkg. Qty.*
PSCBF-COM	PSWBF-COM	VOICE, DATA, FAX	300/300/150	0.56 x 0.19 (14.3 x 4.8)	1 Book (5 pages)
PSCBF-V	PSWBF-V	VOICE	750		
PSCBF-D	PSWBF-D	DATA	750		
PSCBF-BLNK	—	(blank)	750		
PSCBF-COMS	PSWBF-COMS		300/300/150		
PSCBF-VS	PSWBF-VS		750		
PSCBF-DS	PSWBF-DS		750		
PSCBF-FO	PSWBF-FO	FIBER OPTIC,	375/375		
PSCBF-M	—	†See Note	750		

*Order number of books required in multiples of Std. Pkg. Qty.

†Note: PSCBF-M is a "Universal Network Labeling Book" designed to meet most network labeling requirements. Legends include: DATA 1 thru 8, COM 1 thru 8, VOICE 1 thru 8, DATA A thru H, COM A thru H, CAT 5, CAT V, FAX, PHONE, E-NET, LAN, MODEM, PRINTER, 1 thru 8, A thru H and the Data, Voice and Fax symbols shown above.

Surface Mount Box Labels



- Write-on area for marking of extension number, etc. Use Panduit Marking Pen (PFX-0) shown below.

Surface Mount Box Marker Books

Black on Clear Part Number	Legend	Total Markers Each Legend (Book)	Size Width x Length In. (mm)	Std. Pkg. Qty.*
PSCB-COM	VOICE, DATA, FAX	200/200/100	0.56 x 0.56 (14.3 x 14.3)	1 Book (10 pages)
PSCB-V	VOICE	500		
PSCB-D	DATA	500		
PSCB-LAN	LAN	500		
PSCB-BLNK	(blank)	500		
PSCB-COMS		200/200/100		
PSCB-VS		500		
PSCB-DS		500		

*Order number of books required in multiples of Std. Pkg. Qty.

Marking Pens



- Fast drying permanent ink

Part Number	Color	Description	Std. Pkg.*	Std. Ctn.
PX-0	Black	Color of pen is color of ink. Reversible tip to extend life of pen.	12	48
PX-2	Red		12	48
PFX-0	Black	For detailed marking on nylon surfaces. Color cap and end is color of ink.	12	48
PFX-2	Red		12	48

*Order number of pens required in multiple of Std. Pkg. Qty.; Std. Ctn. is for order convenience.

Marker Cards

Solid Numbers

Marker Type	Marker Length In. (mm)	For Max. Wire O.D.
Full	1.50 (38.1)	0.38 (9.5)
Half	0.75 (19.1)	0.19 (4.7)



Type PCM, PACM, PALM and PPM

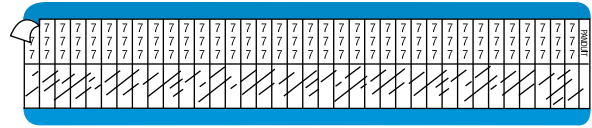

Type PSM

Legend	Part Number					Mkrs Per Card Full/Half †	Std. Pkg. Qty.*
	GMC1 Vinyl Cloth	GMAC Acetate Cloth	GMA1 Aluminum	GMM1 Polyester	GMV3 Self-Lam Vinyl		
0 Thru 25	PCM-0 Thru PCM-25	PACM-0 Thru PACM-25	PALM-0 Thru PALM-25	PPM-0 Thru PPM-25	PSM-0 Thru PSM-25	36/72	25 Cards
Thru 49	Thru PCM-49	—	—	Thru PPM-49	Thru PSM-49	36/72	
Thru 99	Thru PCM-99	—	—	—	Thru PSM-99	36/72	
Thru 200	Thru PCM-200	—	—	—	Thru PSM-200	25/50	
Thru 600	Thru PCM-600	—	—	—	—	25/50	

†Half length markers available for PCM parts above. To order, substitute PCMH for PCM.

Consecutive Numbers



Type PCM, PACM, PALM and PPM

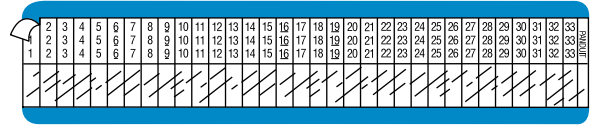

Type PSM

Legend	Part Number					Mkrs Per Card Full/Half †	Std. Pkg. Qty.*
	GMC1 Vinyl Cloth	GMAC Acetate Cloth	GMA1 Aluminum	GMM1 Polyester	GMV3 Self-Lam Vinyl		
1-33 34-66 67-99	PCM-1-33 PCM-34-66 PCM-67-99	PACM-1-33 PACM-34-66 PACM-67-99	PALM-1-33 PALM-34-66 PALM-67-99	PPM-1-33 PPM-34-66 PPM-67-99	PSM-1-33 PSM-34-66 PSM-67-99	33/66 33/66 33/66	25 Cards
100-124 125-149 150-174 Thru 675-699	PCM-100-124 PCM-125-149 PCM-150-174 Thru PCM-675-699	— — — —	— — — —	PPM-100-124 PPM-125-149 PPM-150-174 Thru PPM-675-699	— — — —	25/50 25/50 25/50 25/50	
Thru 1975-1999	Thru PCM-1975-1999	— —	— —	— —	— —	25/50	

†Half length markers available for PCM parts above. To order, substitute PCMH for PCM.

Marker Cards (cont.)

Consecutive Numbers Repeated

Marker Type	Marker Length In. (mm)	For Max. Wire O.D.
Full	1.50 (38.1)	0.38 (9.5)
Half	0.75 (19.1)	0.19 (4.7)



Type PCM, PALM and PPM



Type PSM

Legend	Part Number				Mkrs Per Card Full/Half †	Std. Pkg. Qty.*
	GMC1 Vinyl Cloth	GMA1 Aluminum	GMM1 Polyester	GMV3 Self-Lam Vinyl		
(12) ea. 1-3	PCM-1-3	—	—	—	36/72	25 Cards
(9) ea. 1-4	PCM-1-4	—	—	—	36/72	
(8) ea. 1 (7) ea. 2-5	PCM-1-5	—	—	—	36/72	
(6) ea. 1-6	PCM-1-6	—	PPM-1-6	—	36/72	
(5) ea. 1-4 (4) ea. 5-8	PCM-1-8	—	—	—	36/72	
(4) ea. 1-9	PCM-1-9	—	—	—	36/72	
(4) ea. 0-5 (3) ea. 6-9	PCM-0-9	—	PPM-0-9	PSM-0-9	36/72	
(4) ea. 1-3 (3) ea. 4-10	PCM-1-10	PALM-1-10	—	—	36/72	
(3) ea. 1-12	PCM-1-12	—	PPM-1-12	—	36/72	
(4) ea. 1-4 (3) ea. 5-16	PCM-1-16	—	—	—	36/72	
(2) ea. 1-18	PCM-1-18	—	PPM-1-18	—	36/72	
(2) ea. 19-36	PCM-19-36	—	—	—	36/72	

†Half length markers available for PCM parts above. To order, substitute PCMH for PCM.

Suffix Numbers

Suffix numbers are used to extend numbers or to create alpha-numeric codes. For example, adding suffix number 10 to number 700 creates 70010.



Type PCM



Type PSM

Legend	Part Number		Mkrs Per Card	Std. Pkg. Qty.*
	GMC1 Vinyl Cloth	GMV3 Self-Lam Vinyl		
00	PCM-00	PSM-00	36	25 Cards
01	PCM-01	PSM-01	36	
Thru 09	PCM-09	Thru PSM-09	36	
00-09	PCM-00-09	—	36	

NOTE: Part PCM-00-09 is a card of markers in 00 to 09 sequence with three sequences on a card.

Marker Cards (cont.)

Solid Letters

Marker Type	Marker Length In. (mm)	For Max. Wire O.D.
Full	1.50 (38.1)	0.38 (9.5)
Half	0.75 (19.1)	0.19 (4.7)



Type PCM, PACM, PALM and PPM



Type PSM

Legend	Part Number					Mkrs Per Card Full/Half †	Std. Pkg. Qty.*
	GMC1 Vinyl Cloth	GMAC Acetate Cloth	GMA1 Aluminum	GMM1 Polyester	GMV3 Self-Lam Vinyl		
A B Thru Z	PCM-A PCM-B Thru PCM-Z	PACM-A PACM-B Thru PACM-Z	PALM-A PALM-B Thru PALM-Z	PPM-A PPM-B Thru PPM-Z	PSM-A PSM-B Thru PSM-Z	36/72 36/72 36/72	25 Cards

†Half length markers available for PCM parts above. To order, substitute PCMH for PCM.

Consecutive Letters



PCM-A-Z, PALM-A-Z, PPM-A-Z



PSM-A-Z



PCM-A-Z-0-9



PSM-A-Z-0-9

Legend	Part Number				Mkrs Per Card Full/Half †	Std. Pkg. Qty.*
	GMC1 Vinyl Cloth	GMA1 Aluminum	GMM1 Polyester	GMV3 Self-Lam Vinyl		
(2) ea. A thru J (1) ea. K thru Z	PCM-A-Z	PALM-A-Z	PPM-A-Z	PSM-A-Z	36/72	25 Cards
(1) ea. A thru Z (1) ea. 0 thru 9	PCM-A-Z-0-9	—	—	PSM-A-Z-0-9	36/72	

†Half length markers available for PCM parts above. To order, substitute PCMH for PCM.

Marker Cards (cont.)

Marker Type	Marker Length In. (mm)	For Max. Wire O.D.
Full	1.50 (38.1)	0.38 (9.5)
Half	0.75 (19.1)	0.19 (4.7)

Solid Letters and Numbers (Used in combination with each other)



Type PCM, PALM and PPM



Type PSM

Legend	Part Number				Mkrs Per Card Full/Half †	Std. Pkg. Qty.*
	GMC1 Vinyl Cloth	GMA1 Aluminum	GMM1 Polyester	GMV3 Self-Lam Vinyl		
A1 A2 A3 A4 A5	PCM-A1 PCM-A2 PCM-A3 PCM-A4 PCM-A5	PALM-A1 PALM-A2 — — —	PPM-A1 PPM-A2 — — —	PSM-A1 PSM-A2 PSM-A3 — —	36/72 36/72 36/72 36/72 36/72	25 Cards
B1 Thru B5	PCM-B1 Thru PCM-B5	— — — — —	— — — — —	— — — — —	36/72 36/72	
C1 C2 Thru C5	PCM-C1 PCM-C2 Thru PCM-C5	— — — — —	PPM-C1 PPM-C2 — — —	— — — — —	36/72 36/72 36/72	
D1 Thru D5	— — — — —	— — — — —	— — — — —	PSM-D1 Thru PSM-D5	36/72 36/72	
E1 Thru E5	PCM-E1 Thru PCM-E5	— — — — —	— — — — —	— — — — —	36/72 36/72	
F1 F2 F3 F4 F5	PCM-F1 PCM-F2 PCM-F3 PCM-F4 PCM-F5	PALM-F1 PALM-F2 — — —	PPM-F1 PPM-F2 PPM-F3 — —	— — — — —	36/72 36/72 36/72 36/72 36/72	
H1 Thru H4 H5	PCM-H1 Thru PCM-H4 PCM-H5	— — — — —	PPM-H1 Thru PPM-H4 —	— — — — —	36/72 36/72 36/72	
J1 Thru J4	PCM-J1 Thru PCM-J4	— — — — —	— — — — —	— — — — —	36/72 36/72	
L1 L2 L3 L4 L5	PCM-L1 PCM-L2 PCM-L3 PCM-L4 PCM-L5	PALM-L1 PALM-L2 PALM-L3 — —	PPM-L1 PPM-L2 PPM-L3 — —	PSM-L1 PSM-L2 PSM-L3 — —	36/72 36/72 36/72 36/72 36/72	
M1 Thru M5	PCM-M1 Thru PCM-M5	— — — — —	— — — — —	— — — — —	36/72 36/72	
P1 P2 P3 P4	PCM-P1 PCM-P2 PCM-P3 PCM-P4	PALM-P1 PALM-P2 — — —	PPM-P1 PPM-P2 — — —	— — — — —	36/72 36/72 36/72 36/72	
R1 Thru R5	PCM-R1 Thru PCM-R5	— — — — —	— — — — —	— — — — —	36/72 36/72	
S1 S2 S3 S4 S5	PCM-S1 PCM-S2 PCM-S3 PCM-S4 PCM-S5	PALM-S1 PALM-S2 — — —	PPM-S1 PPM-S2 PPM-S3 PPM-S4 —	— — — — —	36/72 36/72 36/72 36/72 36/72	
T1 T2 T3 T4 T5 T6 Thru T10	PCM-T1 PCM-T2 PCM-T3 PCM-T4 PCM-T5 PCM-T6 Thru PCM-T10	PALM-T1 PALM-T2 PALM-T3 PALM-T4 PALM-T5 PALM-T6 — —	PPM-T1 PPM-T2 PPM-T3 PPM-T4 — — — —	PSM-T1 PSM-T2 PSM-T3 — — — —	36/72 36/72 36/72 36/72 36/72 36/72 36/72	

†Half length markers available for PCM parts above. To order, substitute PCMH for PCM.

More legends shown on next page.

Marker Cards (cont.)

Solid Letters and Numbers (cont.)

Marker Type	Marker Length In. (mm)	For Max. Wire O.D.
Full	1.50 (38.1)	0.38 (9.5)
Half	0.75 (19.1)	0.19 (4.7)

Legend	Part Number				Mkrs Per Card Full/Half †	Std. Pkg. Qty.*
	GMC1 Vinyl Cloth	GMA1 Aluminum	GMM1 Polyester	GMV3 Self-Lam Vinyl		
X1	PCM-X1	PALM-X1	PPM-X1	PSM-X1	36/72	25 Cards
X2	PCM-X2	PALM-X2	PPM-X2	PSM-X2	36/72	
X3	PCM-X3	—	PPM-X3	—	36/72	
X4	PCM-X4	—	PPM-X4	—	36/72	
Y1	PCM-Y1	—	—	—	36/72	
Y2	PCM-Y2	—	—	—	36/72	
Z1	PCM-Z1	—	—	—	36/72	
Z2	PCM-Z2	—	—	—	36/72	
Z3	PCM-Z3	—	—	—	36/72	

†Half length markers available for PCM parts above. To order, substitute PCMH for PCM.

Consecutive Letters and Numbers Repeated



Type PCM

Legend	Part Number	Mkrs Per Card Full/Half †	Std. Pkg. Qty.*
	GMC1 Vinyl Cloth		
(9) ea. A1-A4	PCM-A1-A4	36/72	25 Cards
(9) ea. F1-F4	PCM-F1-F4	36/72	
(9) ea. H1-H4	PCM-H1-H4	36/72	
(9) ea. L1-L4	PCM-L1-L4	36/72	
(9) ea. T1-T4	PCM-T1-T4	36/72	
(9) ea. W1-W4	PCM-W1-W4	36/72	
(9) ea. X1-X4	PCM-X1-X4	36/72	

†Half length markers available for PCM parts above. To order, substitute PCMH for PCM.

Solid NEMA Colors (Blank)



Type PCM and PPM

Color	Part Number		Mkrs Per Card Full/Half †	Std. Pkg. Qty.*
	GMC1 Vinyl Cloth	GMM1 Polyester		
Black	PCM-BLK	PPM-BLK	36/72	25 Cards
Brown	PCM-BRN	PPM-BRN	36/72	
Dark Blue	PCM-DBL	PPM-DBL	36/72	
Dark Green	PCM-DGN	PPM-DGN	36/72	
Gray	PCM-GRY	PPM-GRY	63/72	
Light Blue	PCM-LBL	PPM-LBL	36/72	
Light Green	PCM-LGN	PPM-LGN	36/72	
Orange	PCM-ORN	PPM-ORN	36/72	
Pink	PCM-PNK	PPM-PNK	36/72	
Purple	PCM-PUR	PPM-PUR	36/72	
Red	PCM-RED	PPM-RED	36/72	
Tan	PCM-TAN	PPM-TAN	36/72	
White	PCM-WHT	PPM-WHT	36/72	
Yellow	PCM-YEL	PPM-YEL	36/72	

†Half length markers available for PCM parts above. To order, substitute PCMH for PCM.

Marker Cards (cont.)

Solid Machine Tool Symbols

Marker Type	Marker Length In. (mm)	For Max. Wire O.D.
Full	1.50 (38.1)	0.38 (9.5)
Half	0.75 (19.1)	0.19 (4.7)



Type PCM



Type PSM

Legend	Part Number		Mkrs Per Card Full/Half†	Std. Pkg. Qty.*
	GMC1 Vinyl Cloth	GMV3 Self-Lam Vinyl		
1L1	PCM-1L1	PSM-1L1	25/50	25 Cards
1L2	PCM-1L2	PSM-1L2	25/50	
1L3	PCM-1L3	PSM-1L3	25/50	
2L1	PCM-2L1	PSM-2L1	25/50	
2L2	PCM-2L2	PSM-2L2	25/50	
2L3	PCM-2L3	PSM-2L3	25/50	
3L1	PCM-3L1	PSM-3L1	25/50	
3L2	PCM-3L2	PSM-3L2	25/50	
3L3	PCM-3L3	PSM-3L3	25/50	
4L1	PCM-4L1	PSM-4L1	25/50	
4L2	PCM-4L2	PSM-4L2	25/50	
4L3	PCM-4L3	PSM-4L3	25/50	
4L4	—	PSM-4L4	25/50	
5L1	PCM-5L1	—	25/50	
5L2	PCM-5L2	—	25/50	
5L3	PCM-5L3	—	25/50	
6L1	PCM-6L1	—	25/50	
6L2	PCM-6L2	—	25/50	
6L3	PCM-6L3	—	25/50	
7L1	PCM-7L1	—	25/50	
7L2	PCM-7L2	—	25/50	
7L3	PCM-7L3	—	25/50	
8L1	PCM-8L1	—	25/50	
8L2	PCM-8L2	—	25/50	
8L3	PCM-8L3	—	25/50	
9L1	PCM-9L1	—	25/50	
9L2	PCM-9L2	—	25/50	
9L3	PCM-9L3	—	25/50	
10L1	PCM-10L1	—	25/50	
10L2	PCM-10L2	—	25/50	
10L3	PCM-10L3	—	25/50	
1T1	PCM-1T1	PSM-1T1	25/50	
1T2	PCM-1T2	PSM-1T2	25/50	
1T3	PCM-1T3	PSM-1T3	25/50	
2T1	PCM-2T1	PSM-2T1	25/50	
2T2	PCM-2T2	PSM-2T2	25/50	
2T3	PCM-2T3	PSM-2T3	25/50	
3T1	PCM-3T1	PSM-3T1	25/50	
3T2	PCM-3T2	PSM-3T2	25/50	
3T3	PCM-3T3	PSM-3T3	25/50	
4T1	PCM-4T1	PSM-4T1	25/50	
4T2	PCM-4T2	PSM-4T2	25/50	
4T3	PCM-4T3	PSM-4T3	25/50	
5T1	PCM-5T1	—	25/50	
5T2	PCM-5T2	—	25/50	
5T3	PCM-5T3	—	25/50	
6T1	PCM-6T1	—	25/50	
6T2	PCM-6T2	—	25/50	
6T3	PCM-6T3	—	25/50	
7T1	PCM-7T1	—	25/50	
7T2	PCM-7T2	—	25/50	
7T3	PCM-7T3	—	25/50	

†Half length markers available for PCM parts above. To order, substitute PCMH for PCM.

Marker Cards (cont.)

Consecutive Machine Tool - Repeated

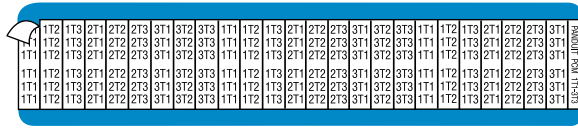

Type PCM

Marker Type	Marker Length In. (mm)	For Max. Wire O.D.
Full	1.50 (38.1)	0.38 (9.5)
Half	0.75 (19.1)	0.19 (4.7)

Legend	Part Number	Mkrs Per Card Full/Half†	Std. Pkg. Qty.*
	GMC1 Vinyl Cloth		
1T1, 1T2, 1T3 2T1, 2T2, 2T3 3T1, 3T2, 3T3	PCM-1T1-3T3	25/50	25 Cards
4T1, 4T2, 4T3 5T1, 5T2, 5T3 6T1, 6T2, 6T3	PCM-4T1-6T3	25/50	
7T1, 7T2, 7T3 8T1, 8T2, 8T3 9T1, 9T2, 9T3	PCM-7T1-9T3	25/50	

†Half length markers available for PCM parts above. To order, substitute PCMH for

Solid Symbols – Misc.



Type PCM and PPM



Type PSM

Legend	Meaning	Part Number			Mkrs Per Card Full/Half†	Std. Pkg. Qty.*
		GMC1 Vinyl Cloth	GMM1 Polyester	GMV3 Self-Lam Vinyl		
A+	A plus	PCM-A-PLS	—	—	36/72	25 Cards
A-	A minus	PCM-A-MNS	—	—	36/72	
A+, A-	A plus, A minus	PCM-A-PM	—	—	18/36	
B+	B plus	PCM-B-PLS	—	—	36/72	
B-	B minus	PCM-B-MNS	—	—	36/72	
NEG	Negative	PCM-NEG	—	—	25/50	
POS	Positive	PCM-POS	—	—	25/50	
+	Plus	PCM-PLS	PPM-PLS	—	36/72	
-	Minus	PCM-MIN	PPM-MIN	—	36/72	
±	Plus or Minus	PCM-PLM	—	—	36/72	
PHASE A	—	PCM-APH	—	—	18/36	
PHASE B	—	PCM-BPH	—	—	18/36	
PHASE C	—	PCM-CPH	—	—	18/36	
1-PHASE	Single Phase	PCM-1PH	—	—	18/36	
AC	Alternating Current	PCM-AC	PPM-AC	—	36/72	
BAT	Battery	PCM-BAT	—	—	25/50	
COM	Common	PCM-COM	—	—	25/50	
DC	Direct Current	PCM-DC	PPM-DC	—	36/72	
GRD	Ground	PCM-GRD	—	—	25/50	
GND	Ground	PCM-GND	PPM-GND	—	25/50	
HOT	Hot	PCM-HOT	—	—	25/50	
IGN	Ignition	PCM-IGN	—	—	25/50	
IN	In	PCM-IN	—	—	36/72	
LINE	Line	PCM-LIN	—	—	18/36	
LOAD	Load	PCM-LOAD	—	—	18/36	
NEUT	Neutral	PCM-NEUT	—	—	18/36	
OUT	Out	PCM-OUT	—	—	25/50	
SPARE	Spare	PCM-SPR	—	PSM-SPARE	18/36	
SS	—	PCM-SS	—	—	36/72	
~	Cycle Symbol	PCM-CYS	—	—	36/72	
⊥	Ground	PCM-GRS	—	—	36/72	
→	Horizontal Arrow	PCM-HRA	—	—	36/72	
↑	Vertical Arrow	PCM-INDA	—	—	36/72	

†Half length markers available for PCM and above. To order, substitute PCMH for PCM.

Marker Cards (cont.)

Solid Voltage Symbols

Marker Type	Marker Length In. (mm)	For Max. Wire O.D.
Full	1.50 (38.1)	0.38 (9.5)
Half	0.75 (19.1)	0.19 (4.7)



Type PCM and PPM

Legend	Part Number		Mkrs Per Card Full/Half†	Std. Pkg. Qty.*
	GMC1 Vinyl Cloth	GMM1 Polyester		
6V	PCM-6V	—	36/72	25 Cards
12V	PCM-12V	—	25/50	
24V	PCM-24V	—	25/50	
110V	PCM-110V	—	20/40	
115V	PCM-115V	—	20/40	
120V	PCM-120V	—	20/40	
220V	PCM-220V	PPM-220V	20/40	
230V	PCM-230V	—	20/40	
240V	PCM-240V	—	20/40	
277V	PCM-277V	—	20/40	
460V	PCM-460V	—	20/40	
480V	PCM-480V	—	20/40	

*Order number of cards required in multiples of Std. Pkg. Qty.

†Half length markers available for PCM parts above. To order, substitute PCMH for PCM.

Number Combination Package - 1 Card Each Number



Legend	Part Number		Mkrs Per Card Full/Half†	Std. Pkg. Qty.*
	GMC1 Vinyl Cloth	GMM1 Polyester		
1 thru 25	PCMCP-1-25	PPMCP-1-25	36/72	1 Pkg. (25 cards per pkg.)
26 thru 50	PCMCP-26-50	PPMCP-26-50	36/72	
51 thru 75	PCMCP-51-75	PPMCP-51-75	36/72	
76 thru 100	PCMCP-76-100	PPMCP-76-100	36/72	
101 thru 125	PCMCP-101-125	PPMCP-101-125	25/50	
126 thru 150	PCMCP-126-150	PPMCP-126-150	25/50	
151 thru 175	PCMCP-151-175	PPMCP-151-175	25/50	
176 thru 200	PCMCP-176-200	PPMCP-176-200	25/50	
201 thru 225	PCMCP-201-225	PPMCP-201-225	25/50	
226 thru 250	PCMCP-226-250	PPMCP-226-250	25/50	
251 thru 275	PCMCP-251-275	PPMCP-251-275	25/50	
276 thru 300	PCMCP-276-300	PPMCP-276-300	25/50	
301 thru 325	PCMCP-301-325	PPMCP-301-325	25/50	
326 thru 350	PCMCP-326-350	PPMCP-326-350	25/50	
351 thru 375	PCMCP-351-375	PPMCP-351-375	25/50	
376 thru 400	PCMCP-376-400	PPMCP-376-400	25/50	
401 thru 425	PCMCP-401-425	—	25/50	
426 thru 450	PCMCP-426-450	—	25/50	
451 thru 475	PCMCP-451-475	—	25/50	
476 thru 500	PCMCP-476-500	—	25/50	
501 thru 525	PCMCP-501-525	—	25/50	
526 thru 550	PCMCP-526-550	—	25/50	
551 thru 575	PCMCP-551-575	—	25/50	
576 thru 600	PCMCP-576-600	—	25/50	

†Half length markers available for PCMCP parts above. To order, substitute PCMHCP for PCMCP.

*Order number of packages required in multiples of Std. Pkg. Qty.

Letter Combination Package - 1 Card Each Letter



Legend	Part Number		Mkrs Per Card Full/Half	Std. Pkg. Qty.*
	GMC1 Vinyl Cloth	GMM1 Polyester		
A thru Z (1 card each)	PCMCP-A-Z	PPMCP-A-Z	36/72	1 Pkg. (26 cards per pkg.)

†Half length markers available for PCMCP parts above. To order, substitute PCMHCP for PCMCP.

*Order number of packages required in multiples of Std. Pkg. Qty.

Marker Cards (cont.)

Consecutive Numbers and Electrical Symbols



Legend	Part Number	Marker Size In. (mm)	For Max Wire O.D.	Mkrs Per Card Full/Half †	Std. Pkg. Qty.*
	GMC1 Vinyl Cloth				
(1) ea. 1-15 (4) ea. AC, DC, POS, NEG. (3) ea. GND (2) ea. Blank	PCM-1-15SYM	Full 0.22 x 1.38 (5.6 x 34.9) Half 0.22 x 0.69 (5.6 x 17.4)	0.38 (9.5) 0.19 (4.7)	36/ 72	25 Cards

*Order number of cards required in multiples of Std. Pkg. Qty.
†Half length markers available for PCM parts above. To order, substitute PCMH for PCM.

Blank Write-on Markers Material: GMV3 Self-Laminating Vinyl



Max. Wire O.D. In. (mm)	Max. Flat Cable In. (mm)	Part Number	Write-On Area Width x Length In. (mm)	Marker Size Width x Length In. (mm)	Markers Per Card	Std. Pkg. Qty.*	
0.25 (6.3)	—	PSWM-375	0.38 x 0.75 (9.5 x 19.1)	0.38 x 1.50 (9.5 x 38.1)	25	25 Cards	
		PSWM-750	0.75 x 0.75 (19.1 x 19.1)	0.75 x 1.50 (19.1 x 38.1)	12		
		PSWM-1500	1.50 x 0.75 (38.1 x 19.1)	1.50 x 1.50 (38.1 x 38.1)	6		
0.13 (3.2)	—	PSWMH-375	0.38 x 0.38 (9.5 x 9.5)	0.38 x 0.75 (9.5 x 19.1)	50		
		PSWMH-750	0.75 x 0.38 (19.1 x 9.5)	0.75 x 0.75 (19.1 x 19.1)	24		
		PSWMH-1500	1.50 x 0.38 (38.1 x 9.5)	1.50 x 0.75 (38.1 x 19.1)	12		
0.69 (17.5)	1.00 (25.4)	PSCC-3	1.00 x 0.75 (25.4 x 19.1)	1.00 x 3.00 (25.4 x 76.2)	3		3
1.25 (31.8)	1.88 (47.6)	PSCC-5	1.00 x 1.00 (25.4 x 25.4)	1.00 x 5.00 (25.4 x 127.0)	3		

*Order number of cards required in multiples of Std. Pkg. Qty.

Miniature Markers

Material: GMT TEDLAR ▲

- For smaller diameter wires
- Black legend on white background

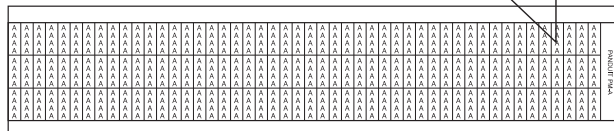
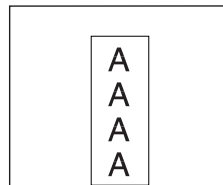

Numbers

Legend	Part Number	Marker Size W X L In. (mm)	Max. Wire O.D. In. (mm)	Markers Per Card	Std. Pkg. Qty.*
0	PM-0	0.18 x 0.50 (4.6 x 12.7)	0.13 (3.2)	150	25 Cards
1	PM-1			150	
Thru 25	Thru PM-25			150	
0 Thru 49	PM-0-49			(3) ea.	
50 Thru 99	PM-50-99			(3) ea.	

Letters

Legend	Part Number	Marker Size W X L In. (mm)	Max. Wire O.D. In. (mm)	Markers Per Card	Std. Pkg. Qty.*
A Thru T U thru Z	PM-A-Z	0.18 x 0.50 (4.6 x 12.7)	0.13 (3.2)	(6) ea. (5) ea.	25 Cards

*Order number of cards required in multiples of Std. Pkg. Qty.
▲TEDLAR is the registered trademark of E. I. DuPont Co.



Conductor Identification Labels

Material: GMY Polyester

- Identification of equipment terminals and terminations of certain designated conductors, ref. IEC 445:1988, DIN EN 60445, DIN 40009, DIN 40011, DIN 40012 and further developments
- Resistant to temperatures up to 275°F (135°C)

Style	Marker Diameter In. (mm)	Markers Per Card
A	0.49 (12.5)	20
B	0.63 (16.0)	20
C	0.79 (20.0)	10
D	0.98 (25.0)	10
E	1.24 (31.5)	10

Part Number					Identification of Conductor—Ends (ref. IEC445, DIN EN 60445)	Legend	Color (Legend/Background)	Std. Pkg. Qty.*
Style A	Style B	Style C	Style D	Style E				
PESS-A-L1	PESS-B-L1	PESS-C-L1	PESS-D-L1	PESS-E-L1	Alternating Current	Outer conductor 1 Outer conductor 2 Outer conductor 3 Neutral conductor	White/Black White/Black White/Black White/Blue	10 cards
PESS-A-L2	PESS-B-L2	PESS-C-L2	PESS-D-L2	PESS-E-L2				
PESS-A-L3	PESS-B-L3	PESS-C-L3	PESS-D-L3	PESS-E-L3				
PESS-A-N	PESS-B-N	PESS-C-N	PESS-D-N	PESS-E-N				
PESS-A-L+	PESS-B-L+	PESS-C-L+	PESS-D-L+	PESS-E-L+	Direct Current	Positive Negative Middle conductor	White/Black White/Black White/Blue	
PESS-A-L-	PESS-B-L-	PESS-C-L-	PESS-D-L-	PESS-E-L-				
PESS-A-M	PESS-B-M	PESS-C-M	PESS-D-M	PESS-E-M				
PESS-A-PE	PESS-B-PE	PESS-C-PE	PESS-D-PE	PESS-E-PE	Protective conductor		Black/Green and Yellow	
PESS-A-PU	PESS-B-PU	PESS-C-PU	PESS-D-PU	PESS-E-PU	Protective conductor no earth			
PESS-A-PEN	PESS-B-PEN	PESS-C-PEN	PESS-D-PEN	PESS-E-PEN	Neutral conductor with protective-function (PEN conductor)			
PESS-A-E	PESS-B-E	PESS-C-E	PESS-D-E	PESS-E-E	Earth		White/Black	
PESS-A-TE	PESS-B-TE	PESS-C-TE	PESS-D-TE	PESS-E-TE	Parasitic current			
PESS-A-MM	PESS-B-MM	PESS-C-MM	PESS-D-MM	PESS-E-MM	Ground			
PESS-A-AQ	PESS-B-AQ	PESS-C-AQ	PESS-D-AQ	PESS-E-AQ	Equal Potential connection			

Part Number					Machinery Materials Identification (ref. DIN 40011)	Legend	Color (Legend/Background)	Std. Pkg. Qty.*
Style A	Style B	Style C	Style D	Style E				
PESS-A-PS	PESS-B-PS	PESS-C-PS	PESS-D-PS	PESS-E-PS	Direct current positive		Black/White	10 Cards
PESS-A-NS	PESS-B-NS	PESS-C-NS	PESS-D-NS	PESS-E-NS	Direct current negative			
PESS-A-SS	PESS-B-SS	PESS-C-SS	PESS-D-SS	PESS-E-SS	Safety function			
PESS-A-ES	PESS-B-ES	PESS-C-ES	PESS-D-ES	PESS-E-ES	Earth			
PESS-A-FS	PESS-B-FS	PESS-C-FS	PESS-D-FS	PESS-E-FS	Parasitic current			
PESS-A-SG	PESS-B-SG	PESS-C-SG	PESS-D-SG	PESS-E-SG	Ground			
PESS-A-SU	PESS-B-SU	PESS-C-SU	PESS-D-SU	PESS-E-SU	Protective isolation			
PESS-A-CE	PESS-B-CE	PESS-C-CE	PESS-D-CE	PESS-E-CE	Certified			

Part Number					Machinery Materials Identification (ref. DIN 40012)	Legend	Color (Legend/Background)	Std. Pkg. Qty.*
Style A	Style B	Style C	Style D	Style E				
PESS-A-EX1	PESS-B-EX1	PESS-C-EX1	PESS-D-EX1	PESS-E-EX1	Explosion Protection		Black/White	10 Cards
PESS-A-EX2	PESS-B-EX2	PESS-C-EX2	PESS-D-EX2	PESS-E-EX2	Explosion Protection			
PESS-A-SCH	PESS-B-SCH	PESS-C-SCH	PESS-D-SCH	PESS-E-SCH	Firedamp Protection			

*Order number of cards required in multiples of Std. Pkg. Qty.

Marker Tape

Wire Marker Tape Dispenser

Material: GMM1 Polyester



EASY TO USE...

1. Open cover, pull out desired length of tape
2. Close cover and press firmly to cut tape

TO RELOAD TAPE...

1. Open cover, drop in tape

UNIQUE DESIGN DISPENSER...

- The tape is cut by depressing the cover and is not torn off by hand. This provides a clean cut-off, with no serrations and insures better adhesion.
- Holds 10 rolls of tape
- Legend is visible through cover window for fast selection
- Tough polypropylene construction, single piece design

Each Roll Features

Universal spool size makes tape usable in other dispenser systems. The tape can be cut to any length so you only use what you actually need. Tabbed end at the beginning of the roll for easier starting



Part Number	Legend	Roll Length	Rolls per Legend per Pkg.	Std. Pkg. Qty.*
DISPENSER				
PMD	(Empty Dispenser)	—	—	1
PMD-0-9	Dispenser filled, legend 0 thru 9	8 ft. (2.4m)	1	1
PMD-NEMA	Dispenser filled, solid colors shown below			

*Order number of dispensers required in multiples of Std. Pkg. Qty.

TAPE

PMDR-0-9 thru PMDR-90-99	0 thru 9 thru 90 thru 99	8 ft. (2.4m)	1	1 Pkg. (10 rolls)
PMDR-0 PMDR-1 thru PMDR-9	0 1 thru 9	8 ft. (2.4m)	10	10 Rolls
PMDR-A thru PMDR-Z	A thru Z	8 ft. (2.4m)	10	10 Rolls
PMDR-L1 PMDR-L2 PMDR-L3	L1 L2 L3	8 ft. (2.4m)	10	10 Rolls
PMDR-T1 PMDR-T2 PMDR-T3	T1 T2 T3	8 ft. (2.4m)	10	10 Rolls
PMDR-CYS PMDR-GRS PMDR-MIN PMDR-PLS	(Cycle Symbol) (Ground Symbol) (Minus Symbol) (Plus Symbol)	8 ft. (2.4m)	10	10 Rolls
PMDR-NEMA	One of each of the NEMA colors featured below	8 ft. (2.4m)	1	1 Pkg. (10 Rolls)
PMDR-BLK	(Black)	8 ft. (2.4m)	10	10 Rolls
PMDR-BL	(Light Blue)			
PMDR-BRN	(Brown)			
PMDR-GRY	(Gray)			
PMDR-GRN	(Light Green)			
PMDR-ORN	(Orange)			
PMDR-PUR	(Purple)			
PMDR-RED	(Red)			
PMDR-WHT	(White)			
PMDR-YEL	(Yellow)			
PMDR-YEL-GRN	(Yellow/Green Striped)			

Legend Height: 1/8" (3.2mm)

*Order number of rolls required in multiples of Std. Pkg. Qty.

Self-Laminating Marker Dispenser

Material: GMV3 Self-Laminating Vinyl



- Dispenser made of tough polypropylene
- Rolls load easily into reusable dispenser
- Mark with Panduit Marking Pens found on [page 137](#)

Part Number	Description	Write-On Area Width x Length In. (mm)	Total Marker Width x Length In. (mm)	Markers Per Roll	Std. Pkg. Qty.*
DISPENSER KIT					
PLD-1	(1) Dispenser, (1) PLDR-1 Tape, (1) PFX-0 Pen	1.00 x 0.38 (25.4 x 9.5)	1.00 x 1.50 (25.4 x 38.1)	200	1 Kit
PLD-2	(1) Dispenser, (1) PLDR-2 Tape, (1) PFX-0 Pen	1.00 x 0.75 (25.4 x 19.1)	1.00 x 3.00 (25.4 x 76.2)	100	1 Kit
TAPE					
PLDR-1	For cable O.D. up to 1/4" (6.3 mm); Flat cable up to 1/2" (12.7 mm) wide	1.00 x 0.38 (25.4 x 9.5)	1.00 x 1.50 (25.4 x 38.1)	200	1 Roll
PLDR-2	For cable O.D. up to 11/16" (17.5 mm); Flat cable up to 1" (25.4 mm) wide	1.00 x 0.75 (25.4 x 19.1)	1.00 x 3.00 (25.4 x 76.2)	100	1 Roll

*Order number of kits or rolls required in multiples of Std. Pkg. Qty.

NOTE: Empty dispenser not sold separately

Slip-On Wire Markers

Material: GMV11 Vinyl Extrusion

- Fully encircle wires, ensuring permanent identification for wire marking applications
- Durable PVC material is impervious to most chemicals and solvents and can be used in most harsh environments
- Available with white or yellow background



Wire O.D. In. (mm)	0.05 - 0.12 (1.3 - 3.0)	0.10 - 0.20 (2.5 - 5.1)	0.16 - 0.39 (4.1 - 9.9)	0.32 - 0.63 (8.1 - 16.0)	0.55 - 0.98 (14.0 - 24.9)
AWG	22 - 16	16 - 10	10 - 4	6 - 00	0 - 350MCM

Standard Pack

Legend	Part Number†				
A	SM02W-A	SM1W-A	SM2W-A	SM3W-A	SM4W-A
B	SM02W-B	SM1W-B	SM2W-B	SM3W-B	SM4W-B
Thru	Thru	Thru	Thru	Thru	Thru
Z	SM02W-Z	SM1W-Z	SM2W-Z	SM3W-Z	SM4W-Z
A-J	SM02W-A-J	SM1W-A-J	SM2W-A-J	—	—
K-T	SM02W-K-T	SM1W-K-T	SM2W-K-T	—	—
U-Z, +, -, /, Blank	SM02W-U-Z	SM1W-U-Z	SM2W-U-Z	—	—
0	SM02W-0	SM1W-0	SM2W-0	SM3W-0	SM4W-0
1	SM02W-1	SM1W-1	SM2W-1	SM3W-1	SM4W-1
Thru	Thru	Thru	Thru	Thru	Thru
9	SM02W-9	SM1W-9	SM2W-9	SM3W-9	SM4W-9
0-9	SM02W-0-9	SM1W-0-9	SM2W-0-9	—	—
+	SM02W-PLS	SM1W-PLS	SM2W-PLS	SM3W-PLS	SM4W-PLS
-	SM02W-MNS	SM1W-MNS	SM2W-MNS	SM3W-MNS	SM4W-MNS
/	SM02W-SLH	SM1W-SLH	SM2W-SLH	SM3W-SLH	SM4W-SLH
(Ground Symbol)	SM02W-GND	SM1W-GND	SM2W-GND	SM3W-GND	SM4W-GND
Blank	SM02W-BLNK	SM1W-BLNK	SM2W-BLNK	SM3W-BLNK	SM4W-BLNK
Std. Pkg. Contents	10 strips of 25 markers	10 strips of 25 markers	10 strips of 25 markers	1 bag of 100 loose markers	1 bag of 20 loose markers
Std. Pkg. Qty.*	1 Pkg.	1 Pkg.	1 Pkg.	1 Pkg.	1 Pkg.

Bulk Pack

Legend	Part Number†				
A	SMB02W-A	SMB1W-A	SMB2W-A	SMB3W-A	SMB4W-A
B	SMB02W-B	SMB1W-B	SMB2W-B	SMB3W-B	SMB4W-B
Thru	Thru	Thru	Thru	Thru	Thru
Z	SMB02W-Z	SMB1W-Z	SMB2W-Z	SMB3W-Z	SMB4W-Z
0	SMB02W-0	SMB1W-0	SMB2W-0	SMB3W-0	SMB4W-0
1	SMB02W-1	SMB1W-1	SMB2W-1	SMB3W-1	SMB4W-1
Thru	Thru	Thru	Thru	Thru	Thru
9	SMB02W-9	SMB1W-9	SMB2W-9	SMB3W-9	SMB4W-9
+	SMB02W-PLS	SMB1W-PLS	SMB2W-PLS	SMB3W-PLS	SMB4W-PLS
-	SMB02W-MNS	SMB1W-MNS	SMB2W-MNS	SMB3W-MNS	SMB4W-MNS
/	SMB02W-SLH	SMB1W-SLH	SMB2W-SLH	SMB3W-SLH	SMB4W-SLH
(Ground Symbol)	SMB02W-GND	SMB1W-GND	SMB2W-GND	SMB3W-GND	SMB4W-GND
Blank	SMB02W-BLNK	SMB1W-BLNK	SMB2W-BLNK	SMB3W-BLNK	SMB4W-BLNK
Bulk Pkg. Contents	1 strip of 1000 markers	1 strip of 1000 markers	1 strip of 1000 markers	1 bag of 250 loose markers	5 bags of 20 loose markers
Bulk Pkg. Qty.*	1 Pkg.	1 Pkg.	1 Pkg.	1 Pkg.	1 Pkg.

*Order number of packages required in multiples of Std. Pkg. Qty.

†Part numbers shown have white background. To order yellow background replace "W" with "Y". For example, SM02Y-A has yellow background.

Clip-On Wire Markers

Clip-On Wire Markers

Material: GMACT Acetal

- Easy to install – markers snap on wire
- Can be removed and reused
- Exceed requirements of MIL-H-5606 and MIL-L-7808
- Available with white or yellow background

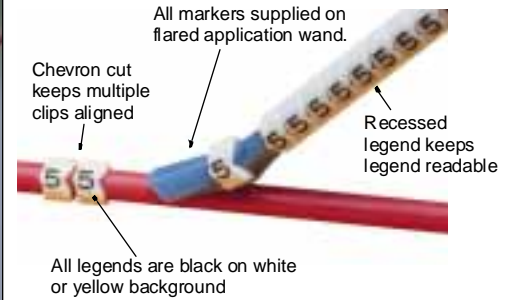

Refer to Wire Size Selection Guide on [page 196](#) to review diameters of commonly used wire and cable.

Wire O.D. In. (mm)	0.08 - 0.10 (2.0 - 2.5)	0.11 - 0.13 (2.8 - 3.3)	0.13 - 0.15 (3.3 - 3.8)	0.19 - 0.23 (4.8 - 5.8)	0.23 - 0.37 (5.8 - 9.4)	0.23 - 0.37 (5.8 - 9.4)	0.36 - 0.45 (9.1 - 11.4)	0.45 - 0.62 (11.4 - 15.7)
-----------------------	----------------------------	----------------------------	----------------------------	----------------------------	----------------------------	----------------------------	-----------------------------	------------------------------

Legend	Part Number†							
A	PCA07-A	PCA11-A	PCA13-A	PCA18-A	PCA23-A	–	PCA36-A	PCA45-A
B	PCA07-B	PCA11-B	PCA13-B	PCA18-B	PCA23-B	–	PCA36-B	PCA45-B
Thru	Thru	Thru	Thru	Thru	Thru	–	Thru	Thru
Z	PCA07-Z	PCA11-Z	PCA13-Z	PCA18-Z	PCA23-Z	–	PCA36-Z	PCA45-Z
A-J	PCA07-A-J	PCA11-A-J	PCA13-A-J	PCA18-A-J	–	–	–	–
K-T	PCA07-K-T	PCA11-K-T	PCA13-K-T	PCA18-K-T	–	–	–	–
U-Z	PCA07-U-Z	PCA11-U-Z	PCA13-U-Z	PCA18-U-Z	–	–	–	–
A-D	–	–	–	–	–	PCA23-A-D	PCA36-A-D	PCA45-A-D
E-H	–	–	–	–	–	PCA23-E-H	PCA36-E-H	PCA45-E-H
I-L	–	–	–	–	–	PCA23-I-L	PCA36-I-L	PCA45-I-L
M-P	–	–	–	–	–	PCA23-M-P	PCA36-M-P	PCA45-M-P
Q-T	–	–	–	–	–	PCA23-Q-T	PCA36-Q-T	PCA45-Q-T
U-X	–	–	–	–	–	PCA23-U-X	PCA36-U-X	PCA45-U-X
Y-Z	–	–	–	–	–	PCA23-Y-Z	PCA36-Y-Z	PCA45-Y-Z
0	PCA07-0	PCA11-0	PCA13-0	PCA18-0	PCA23-0	–	PCA36-0	PCA45-0
1	PCA07-1	PCA11-1	PCA13-1	PCA18-1	PCA23-1	–	PCA36-1	PCA45-1
Thru	Thru	Thru	Thru	Thru	Thru	–	Thru	Thru
9	PCA07-9	PCA11-9	PCA13-9	PCA18-9	PCA23-9	–	PCA36-9	PCA45-9
0-9	PCA07-0-9	PCA11-0-9	PCA13-0-9	PCA18-0-9	–	–	–	–
0-3	–	–	–	–	–	PCA23-0-3	PCA36-0-3	PCA45-0-3
4-7	–	–	–	–	–	PCA23-4-7	PCA36-4-7	PCA45-4-7
8, 9, +, -	–	–	–	–	–	PCA23-8-9	PCA36-8-9	PCA45-8-9
+	PCA07-PLS	PCA11-PLS	PCA13-PLS	PCA18-PLS	PCA23-PLS	–	PCA36-PLS	PCA45-PLS
–	PCA07-MIN	PCA11-MIN	PCA13-MIN	PCA18-MIN	PCA23-MIN	–	PCA36-MIN	PCA45-MIN
30 Clips per application wand = 300 Clips total/pkg.					20 Clips per wand = 60 clips total/pkg.	20 Clips per wand = 80 clips total/pkg.	15 Clips per wand = 60 clips total/pkg.	
10 Wands/Pkg.					3 Wands/Pkg.	4 Wands/Pkg.	4 Wands/Pkg.	
Std. Pkg. Qty.* = 1 pkg.								

*Order number of packages required in multiples of Std. Pkg. Qty.

†Part numbers shown have white background. To order yellow background replace "PCA" with "PCAY". For example, PCAY07-A has yellow background.

Cable Marking Products

Selection of Styles



Self-Laminating Cable Marker Holders **Page 152**

Durable tag to mark large cables and cable bundles. Holders can be used with labels printed on any printer, or legend can be hand-written directly onto holder. Clear overlamine protects legend.



Clear Heat Shrink Tubing **Page 153**

Clear heat shrink is applied over label to protect legends on wires and cables. Available for diameters from 0.19" - 2.00" (4.8 mm - 50.8 mm).



Fiber Optic Cable Marker Tags **Page 154**

Self-laminating tag for marking fiber optic cable in manhole and indoor environments. Clear overlamine protects legend.



Ground Warning Tags **Page 154**

UV resistant tags provide ground clamp warning.



Fiber Optic Conduit Markers **Page 155**

Durable markers available in adhesive and snap-on styles.



Underground Hazard Tape **Page 155**

Used to warn of buried cable lines, these non-adhesive tapes will not biodegrade. Available in detectable aluminum foil laminate and polyethylene materials in a variety of legends, colors and sizes.

Self-Laminating Cable Marker Holders for Large Cables and Bundles



- Durable tag to mark a wide range of cables and cable bundles
- Can be used with printer generated labels or hand-written
- Attaches easily with Panduit intermediate or standard cross-section nylon cable ties or Panduit **TAK-TY™** Hook and Loop Cable Ties
- Ideal for use with Panduit hand-held printers, such as the LS3E, LS5 and LS5E
- Clear overlaminates protect legend
- Can be applied as a wrap-around marker (parallel to cable) or flag marker (45° or 90° to cable)
- Available in white, yellow, orange, gray and brown
- Large label area provides ample room for complex labeling schemes

Marker Holders

Part Number	Color	Size In. (mm)	Holders Per Pkg.	Std. Pkg. Qty.*
SLCT-WH	White	3.00 x 1.31 (76.2 x 33.3)	25	1 Pkg.
SLCT-YL	Yellow			
SLCT-OR	Orange			
SLCT-IG	Gray			
SLCT-BR	Brown			

*Order number of packages required in multiples of Std. Pkg. Qty.

Recommended Labels

Part Number	Printer Used	Size In. (mm)	Color	Std. Pkg. Qty.*
L3PL3WH	Panduit LS3E	2.00 x 1.00 (50.8 x 25.4)	White	1 Roll (100 Labels)
L3PL3CL			Clear	
LS5-33	Panduit LS5 / LS5E	1.00 x 40 ft. (25.4 x 12.2 m)	Black/White	1 Cartridge
LS5-30			Black/Clear	
PLL-17-Y2-1	Laser	1.88 x 0.83 (47.6 x 21.1)	White	1000 Labels
JL41PO-0.5	Ink Jet	2.00 x 0.90 (50.8 x 22.9)	White	500 Labels
PDL-301	Dot-Matrix	2.00 x 0.90 (50.8 x 22.9)	White	1000 Labels

* For LS3E Labels, order number of rolls required in multiples of Std. Pkg. Qty.
 For LS5 Cartridges, order number of cartridges required in multiples of Std. Pkg. Qty.
 For Laser, Ink Jet and Dot-Matrix Labels, order number of labels required in multiples of Std. Pkg. Qty.

Cable Ties

Part Number	Max. Bundle Diameter In. (mm)	Min. Loop Tensile Strength Lbs. (N)	Std. Pkg. Qty.*
PAN-TY® Nylon Self-Locking Cable Ties			
PLT1.5L-C	1.38 (35)	40 (178)	100
PLT2L-C	2.00 (51)		
PLT3L-C	3.00 (76)		
PLT4L-C	4.00 (102)		
PLT2S-C	1.88 (48)	50 (222)	100
PLT3S-C	3.00 (76)		
PLT4S-C	4.00 (102)		
PLT5S-C	5.00 (127)		
TAK-TY® Hook and Loop Cable Ties			
HLT2L-X0†	1.90 (48)	40 (178)	10
HLT3L-X0†	3.20 (81)		
TAK-TY® Hook and Loop Continuous 15 Ft. Roll			
HLM-15R0†	N/A	18 (80)	1 Roll

*Order number of ties required in multiples of Std. Pkg. Qty.

†TAK-TY parts shown are black, contact factory for part number information on other colors

Create Custom Cable Markers Quickly and Easily — On-Site!



1. Print label with the LS3E Hand-Held Dot-Matrix Printer or print label on any other printer. When a printer is not available, legend can also be written directly on marker holder.



2. Apply label to marker holder.



3. Remove liner on overlaminates flap to expose adhesive.



4. Fold down overlaminates flap to protect label.



5. Attach to cable bundle with Panduit cable ties.

Clear Heat Shrink Tubing for Protected Wire and Cable Marking

- Use with any label to provide protected legends for harsh environments
- Use with Panduit Heat Shrink Tools and Accessories shown on [page 123](#)



- Available in 3 package sizes
- Material: Clear 2:1 Polyolefin
- Temperature Range: -67°F to 275°F (-55°C to 135°C)
- Mil Spec: MIL-I 23053/5 Class 2
- Shrink Temperature: 248°F (120°C)

Heat Shrink Tubing					Suggested Labels			
Part Number	Nominal Cable O.D.* In. (mm)	Length	Pieces Per Pkg.	Std. Pkg. Qty.*	Printer Used	Panduit Label Part Number	Label Width x Length In. (mm)	Label Std. Pkg. Qty.*
HSTT38-YC	0.19 - 0.38 (4.8 - 9.5)	6" (152 mm)	12	1 Pkg.	Ink Jet Thermal Transfer Dot-Matrix	JL412PO-1 TTC4T-10 PDL-189	1.38 x 0.19 (34.9 x 4.8) 0.65 x 0.20 (16.5 x 5.1) 0.65 x 0.20 (16.5 x 5.1)	1000 Labels 10,000 Labels 5000 Labels
HSTT38-48-QC		4' (1.2 m) Piece	25	25 Pieces				
HSTT38-QC		25' (7.5 m) Reel	1	1 Reel				
HSTT50-YC	0.25 - 0.50 (6.4 - 12.7)	6" (152 mm)	10	1 Pkg.	LS3E Laser Ink Jet Thermal Transfer Dot-Matrix	LC-7 PLL-14-PO-5 JL412PO-1 TTC6T-10 PDL-190	1.00 x 0.28 (25.4 x 7.0) 1.50 x 0.25 (38.1 x 6.4) 1.38 x 0.19 (34.9 x 4.8) 0.90 x 0.25 (22.9 x 6.4) 0.75 x 0.25 (19.1 x 6.4)	1 Roll (500 Labels) 5000 Labels 1000 Labels 10,000 Labels 5000 Labels
HSTT50-48-5C		4' (1.2 m) Piece	5	5 Pieces				
HSTT50-QC		25' (7.5 m) Reel	1	1 Reel				
HSTT75-YC	0.38 - 0.75 (9.5 - 19.1)	6" (152 mm)	8	1 Pkg.	LS3E Laser Ink Jet Thermal Transfer Dot-Matrix	LC-9 PLL-8-PO-10 JL412PO-1 TTC6T-10 PDL-132	1.00 x 0.40 (25.4 x 10.2) 1.00 x 0.38 (25.4 x 9.5) 1.38 x 0.19 (34.9 x 4.8) 0.90 x 0.25 (22.9 x 6.4) 1.25 x 0.38 (31.8 x 9.5)	1 Roll (500 Labels) 10,000 Labels 1000 Labels 10,000 Labels 5000 Labels
HSTT75-48-5C		4' (1.2 m) Piece	5	5 Pieces				
HSTT75-QC		25' (7.5 m) Reel	1	1 Reel				
HSTT100-YC	0.50 - 1.00 (12.7 - 25.4)	6" (152 mm)	6	1 Pkg.	LS3E Laser Ink Jet Thermal Transfer Dot-Matrix	LC-10 PLL-8-PO-10 JL33PO-2.5 TTC8T-10 PDL-188	1.00 x 0.50 (25.4 x 12.7) 1.00 x 0.38 (25.4 x 9.5) 1.44 x 0.50 (36.5 x 12.7) 1.00 x 0.50 (25.4 x 12.7) 1.00 x 0.50 (25.4 x 12.7)	1 Roll (500 Labels) 10,000 Labels 2500 Labels 10,000 Labels 5000 Labels
HSTT100-48-5C		4' (1.2 m) Piece	5	5 Pieces				
HSTT100-CC		100' (30.5 m) Reel	1	1 Reel				
HSTT150-48-5C	0.75 - 1.50 (19.1 - 38.1)	4' (1.2 m) Piece	5	5 Pieces	LS3E Laser Ink Jet Thermal Transfer Dot-Matrix	LC-4 PLL-10-PO-5 JL33PO-2.5 TTC8T-10 PDL-188	1.00 x 0.75 (25.4 x 19.1) 1.00 x 0.75 (25.4 x 19.1) 1.44 x 0.50 (36.5 x 12.7) 1.00 x 0.50 (25.4 x 12.7) 1.00 x 0.50 (25.4 x 12.7)	1 Roll (500 Labels) 5000 Labels 2500 Labels 10,000 Labels 5000 Labels
HSTT150-CC		100' (30.5 m) Reel	1	1 Reel				
HSTT200-48-5C	1.00 - 2.00 (25.4 - 50.8)	4' (1.2 m) Piece	5	5 Pieces	LS3E Laser Ink Jet Thermal Transfer Dot-Matrix	LC-2 PLL-10-PO-5 JL33PO-2.5 TTC8T-10 PDL-188	1.00 x 1.00 (25.4 x 25.4) 1.00 x 0.75 (25.4 x 19.1) 1.44 x 0.50 (36.5 x 12.7) 1.00 x 0.50 (25.4 x 12.7) 1.00 x 0.50 (25.4 x 12.7)	1 Roll (250 Labels) 5000 Labels 2500 Labels 10,000 Labels 5000 Labels
HSTT200-LC		50' (15.2 m) Reel	1	1 Reel				

Heat Shrink Data Label Kits

- Fast and easy way to produce subsurface printed custom labels with any dot-matrix printer
- Each kit contains 1000 pre-cut clear heat shrink tubes, 1.50" (38.1 mm) long and 1000 dot-matrix labels listed

Part Number	Nominal Cable O.D.* In. (mm)	Labels Included	Label Size Width x Length In. (mm)	Std Pkg. Qty.*
HSDL9-12-94	0.06 - 0.13 (1.6 - 3.2)	PDL-94	0.90 x 0.25 (22.9 x 6.3)	1000 Kits
HSDL9-12-285		PDL-285	0.90 x 0.25 (22.9 x 6.3)	1000 Kits
HSDL9-25-94	0.13 - 0.25 (3.2 - 6.4)	PDL-94	0.90 x 0.25 (22.9 x 6.3)	1000 Kits
HSDL9-25-285		PDL-285	0.90 x 0.25 (22.9 x 6.3)	1000 Kits
HSDL9-37-31	0.18 - 0.35 (4.4 - 8.9)	PDL-31	1.00 x 0.38 (25.4 x 9.5)	1000 Kits
HSDL9-50-31	0.25 - 0.50 (6.4 - 12.7)	PDL-31	1.00 x 0.38 (25.4 x 9.5)	1000 Kits
HSDL9-75-20	0.38 - 0.75 (9.5 - 19.1)	PDL-20	1.00 x 0.38 (25.4 x 9.5)	1000 Kits
HSDL9-100-293	0.50 - 1.00 (12.7 - 25.4)	PDL-293	1.00 x 0.38 (25.4 x 9.5)	1000 Kits

* Refer to Wire Size Selection Guide on [page 196](#) to review diameters of commonly used cables
* Order number required in multiples of Std. Pkg. Qty.



Self-Laminating Fiber Optic Cable Marker Tags

- Durable tag for marking fiber optic cable in manhole and indoor environments
- Clear overlaminates protect legend
- Can be marked with Panduit Permanent Marker Pens (see [pg. 137](#))
- Can be installed as a wrap or flag with Panduit Intermediate Cable Ties shown below

(6) slots: 0.31" x 0.13" (7.9 x 3.2 mm)

Part Number	Material	Size Width x Length In. (mm)	Legend / Background Color	Legend	Tags Per Pkg.	Std. Pkg. Qty.*
PST-FO†	GMV4 Self-Laminating Rigid Vinyl	3.50 x 2.00 (88.9 x 50.8)	Black/Yellow	CAUTION FIBER OPTIC CABLE TYPE _____ COUNT _____	5 Tags	1 Pkg.
PST-FOBLNK			Yellow	Blank		

†Also available in Spanish and Portuguese. To order, add part number suffix -E for Spanish or -P for Portuguese
*Order number of packages required in multiples of Std. Pkg. Qty.



Ground Warning Tags

- U.V. resistant legend is printed on both sides
- Install with Panduit Intermediate Cable Ties shown below
- PT-BLNK tag can be marked with Panduit Permanent Marker Pens (see [pg. 137](#)) for indoor use

(1) slot: 0.13" x 0.63" (3.2 x 15.9 mm)

Part Number	Material	Size Width x Length In. (mm)	Legend / Background Color	Legend	Tags Per Pkg.	Std. Pkg. Qty.*
PT-CGND†	GMPE3 Semi-Rigid Polyethylene	2.75 x 1.38 (69.9 x 34.9)	Black/Yellow —	WARNING...CABLE TV CO. REPAIR SERVICE	100 Tags	1 Pkg.
PT-EGND†				WARNING...ELECTRICAL CO. REPAIR SERVICE		
PT-TGND†				WARNING...TELEPHONE CO. REPAIR SERVICE		
PT-GND†				WARNING, GROUND WIRE, DO NOT REMOVE		
PT-BLNK				(Blank)		

†Also available in Spanish and Portuguese. To order, add part number suffix -E for Spanish or -P for Portuguese
*Order number of packages required in multiples of Std. Pkg. Qty.

Intermediate Cross Section Cable Ties

- For use with Panduit Cable Markers
- Available in two styles
 - **DOME-TOP® BARB-TY®** Cable Ties have a metal barb
 - **PAN-TY®** Cable Ties are an all plastic, one-piece construction
- Sizes to accommodate up to 4.00" (101.5 mm) bundles
- Indoor and Outdoor materials available

Part Number	Max. Bundle Diameter In. (mm)	Length In. (mm)	Width In. (mm)	Min. Loop Tensile Strength Lbs. (N)	Material†	Std. Pkg. Qty.*
DOME-TOP BARB-TY Cable Ties						
BT1.5I-C	1.50 (38.1)	6.1 (155)	0.14 (3.6)	40 (178)	Natural Nylon 6.6 (Indoor)	100
BT2I-C	2.00 (50.8)	8.0 (203)				
BT3I-C	3.00 (76.2)	11.1 (282)				
BT4I-C	4.00 (101.6)	14.3 (363)				
PAN-TY Cable Ties						
PLT1.5I-C	1.38 (34.9)	5.6 (142)	0.14 (3.6)	40 (178)	Natural Nylon 6.6 (Indoor)	100
PLT2I-C	2.00 (50.8)	8.0 (203)				
PLT2.5I-C	2.50 (63.5)	9.7 (246)				
PLT3I-C	3.00 (76.2)	11.4 (290)				
PLT4I-C	4.00 (101.6)	14.6 (371)				

*Order number of pieces required in multiples of Std. Pkg. Qty.
†Ties also available in Black Weather Resistant Nylon 6.6. To order, add "0" to part number, i.e. BT1.5I-C0.

Fiber Optic Conduit Markers



- Durable markers available in adhesive or snap-on styles

Style	Pipe / Conduit O.D. In. (mm)	Marker Size Width x Length In. (mm)	Markers Per Card	Std. Pkg. Qty.*
Adhesive Marker Cards				
A	3.00 (76.2) and Over	9.00 x 2.25 (228.6 x 57.2)	1	5 Cards
B	1.25 - 3.00 (31.8 - 76.2)	4.50 x 1.19 (114.3 x 28.6)	4	
C	1.25 (31.8) and Under	2.25 x 0.50 (57.1 x 12.7)	18	
Snap-On Markers (Non-Adhesive)				
M	2.25 - 6.00 (57.2 - 152.4)	14.00 x 23.00 (355.6 x 584.2)	1	1 Marker
R	0.75 - 2.25 (19.1 - 57.2)	8.00 x 8.00 (203.2 x 203.2)	1	

* For Styles A, B and C, order number of cards required in multiples of Std. Pkg. Qty.; for Styles M and R, order number of markers required in multiples of Std. Pkg. Qty.

Part Numbers					Legend	Color (Legend/ Background)
Style A	Style B	Style C	Style M	Style R		
PCV-FOA†	PCV-FOB†	PCV-FOC†	PCV-FOM	PCV-FOR	Fiber Optic	Black/Orange
PCV-FOCA	PCV-FOCB	PCV-FOCC	PCV-FOCM	PCV-FOCR	Fiber Optic Cable	
PCV-FOSA	PCV-FOSB	PCV-FOSC	—	—	⚡— (Fiber Optic Symbol)	

†Also available in Spanish and Portuguese. To order, add part number suffix -E for Spanish or -P for Portuguese

Underground Hazard Tape



- Used to warn of buried cable lines
- Non-adhesive tape will not biodegrade
- Available in detectable aluminum foil laminate and polyethylene materials

Legend	Background Color	Detectable Tape Part Number			Polyethylene Tape Part Number		Std. Pkg. Qty.*
		2" x 1000 ft. (51 mm x 305 m)	3" x 1000 ft. (76 mm x 305 m)	6" x 1000 ft. (152 mm x 305 m)	3" x 2000 ft. (76 mm x 610 m)	6" x 1000 ft. (152 mm x 305 m)	
CAUTION CAUTION CAUTION CABLE T.V. LINE BURIED BELOW	Orange	HTDU20-TV	HTDU30-TV	HTDU60-TV	—	HTU60-TV†	1 Roll
	Green	—	—	—	HTU3G-TV†	HTU6G-TV†	
CAUTION CAUTION CAUTION ELECTRIC LINE BURIED BELOW	Red	HTDU2R-E	HTDU3R-E	HTDU6R-E	HTU3R-E†	HTU6R-E†	
	Yellow	—	—	—	HTU3Y-E†	HTU6Y-E†	
CAUTION CAUTION CAUTION TELEPHONE LINE BURIED BELOW	Orange	HTDU20-T	HTDU30-T	HTDU60-T	HTU30-T†	HTU60-T	
	Green	—	—	—	HTU3G-T†	HTU6G-T†	
CAUTION CAUTION CAUTION BURIED FIBER OPTIC CABLE	Orange	HTDU20-FO	HTDU30-FO	HTDU60-FO	HTU30-FO†	HTU60-FO†	

†Also available in Spanish and Portuguese. To order, add part number suffix -E for Spanish or -P for Portuguese
*Order number of rolls required in multiples of Std. Pkg. Qty.

Voltage and Fiber Optic Markers

Available in two styles:



Adhesive Marker Cards

- Durable GMV1 Indoor Vinyl Material
- Available in 3 sizes



Snap-On Markers (Non-Adhesive)

- Pre-coiled, sub-surface printed markers for indoor use
- Available in 2 sizes

Style	Type	Pipe / Conduit O.D. In. (mm)	Marker Size Width x Length In. (mm)	Markers Per Card	Std. Pkg. Qty.*
A	Adhesive Marker Cards	3.00 (76.2) and Over	9.00 x 2.25 (228.6 x 57.1)	1	5 Cards
B		1.25 - 3.00 (31.7 - 76.2)	4.50 x 1.13 (114.3 x 28.6)	4	
C		1.25 (31.7) and Under	2.25 x 0.50 (57.1 x 12.7)	18	
M	Snap-On Markers (Non-Adhesive)	2.25 - 6.00 (57.2 - 152.4)	14.00 x 23.00 (355.6 x 584.2)	1	1 Marker
R		0.75 - 2.25 (19.1 x 57.2)	8.00 x 8.00 (203.2 x 203.2)	1	

*For Styles A, B, and C, order number of cards required in multiples of Std. Pkg. Qty; for Styles M and R, order number of markers required in multiples of Std. Pkg. Qty.

Part Number†					Legend	Color (Legend/Bkrd)
Style A	Style B	Style C	Style M	Style R		
PCV-VOLTSA	PCV-VOLTSB	PCV-VOLTSC	—	—	— VOLTS	Black/Orange
PCV-110A	PCV-110B	PCV-110C	—	—	110 Volts	
PCV-115A	PCV-115B	PCV-115C	—	—	115 Volts	
PCV-120A	PCV-120B	PCV-120C	PCV-120M	PCV-120R	120 Volts	
PCV-208A	PCV-208B	PCV-208C	PCV-208M	PCV-208R	208 Volts	
PCV-220A	PCV-220B	PCV-220C	—	—	220 Volts	
PCV-230A	PCV-230B	PCV-230C	—	—	230 Volts	
PCV-240A	PCV-240B	PCV-240C	—	—	240 Volts	
PCV-250A	PCV-250B	PCV-250C	—	—	250 Volts	
PCV-277A	PCV-277B	PCV-277C	—	—	277 Volts	
PCV-380A	PCV-380B	PCV-380C	—	—	380 Volts	
PCV-415A	PCV-415B	PCV-415C	—	—	415 Volts	
PCV-440A	PCV-440B	PCV-440C	—	—	440 Volts	
PCV-460A	PCV-460B	PCV-460C	—	—	460 Volts	
PCV-480A	PCV-480B	PCV-480C	PCV-480M	PCV-480R	480 Volts	
PCV-550A	PCV-550B	PCV-550C	—	—	550 Volts	
PCV-600A	PCV-600B	PCV-600C	PCV-600M	PCV-600R	600 Volts	
PCV-2200A	PCV-2200B	—	—	—	2200 Volts	
PCV-2300A	PCV-2300B	PCV-2300C	—	—	2300 Volts	
PCV-2400A	PCV-2400B	PCV-2400C	—	—	2400 Volts	
PCV-4160A	PCV-4160B	PCV-4160C	PCV-4160M	—	4160 Volts	
PCV-4800A	PCV-4800B	—	—	—	4800 Volts	
PCV-5000A	PCV-5000B	—	—	—	5000 Volts	
PCV-6900A	PCV-6900B	—	—	—	6900 Volts	
PCV-7200A	PCV-7200B	—	—	—	7200 Volts	
PCV-12000A	PCV-12000B	PCV-12000C	—	—	12000 Volts	
PCV-12470A	PCV-12470B	PCV-12470C	—	—	12470 Volts	
PCV-13000A	PCV-13000B	—	—	—	13000 Volts	
PCV-13200A	PCV-13200B	PCV-13200C	—	—	13200 Volts	
PCV-13800A	PCV-13800B	PCV-13800C	—	—	13800 Volts	

†Most legends also available in Spanish and Portuguese. To order, add part number suffix -E for Spanish or -P for Portuguese

More legends shown on the following page.

Voltage and Fiber Optic Markers (cont.)

Part Number†					Legend	Color (Legend/Bkrd)
Style A	Style B	Style C	Style M	Style R		
PCV-120/208A	PCV-120/208B	PCV-120/208C	PCV-120/208M	PCV-120/208R	120/208 Volts	Black/Orange
PCV-240/480A	PCV-240/480B	PCV-240/480C	—	—	240/480 Volts	Black/Orange
PCV-277/480A	PCV-277/480B	PCV-277/480C	—	—	277/480 Volts	Black/Orange
PCV-ACA	PCV-ACB	PCV-ACC	—	—	AC	Black/Orange
PCV-DCA	PCV-DCB	PCV-DCC	—	—	DC	Black/Orange
PCV-A/CA	PCV-A/CB	PCV-A/CC	—	—	Air Cond.	Black/Orange
PCV-BLANKA	PCV-BLANKB	PCV-BLANKC	—	—	Blank-No Legend	Black/Orange
PCV-CHTA	PCV-CHTB	PCV-CHTC	PCV-CHTM	PCV-CHTR	Caution-Heat Traced	Black/Orange
PCV-CNA	PCV-CNB	PCV-CNC	—	—	Circuit #	Black/Orange
PCV-CBA	PCV-CBB	PCV-CBC	—	—	Circuit Breaker	Black/Orange
PCV-EOOSA	PCV-EOOSB	PCV-EOOSC	—	—	Electric Out of Service	Black/Orange
PCV-ESA	PCV-ESB	PCV-ESC	—	—	Emergency Service	Black/Orange
PCV-EXL TSA	PCV-EXL TSB	PCV-EXL TSC	—	—	Exit Lights	Black/Orange
PCV-FAA	PCV-FAB	PCV-FAC	—	—	Fire Alarm	Black/Orange
PCV-FOA	PCV-FOB	PCV-FOC	PCV-FOM	PCV-FOR	Fiber Optic	Black/Orange
PCV-FOCA	PCV-FOCB	PCV-FOCC	PCV-FOCM	PCV-FOCR	Fiber Optic Cable	Black/Orange
PCV-FOSA	PCV-FOSB	PCV-FOSC	—	—	 (Fiber Optic Symbol)	Black/Orange
PCV-FBOXA	PCV-FBOXB	PCV-FBOXC	—	—	Fuse Box	Black/Orange
PCV-HTCRTA	PCV-HTCRTB	PCV-HTCRTC	—	—	Heating Circuit	Black/Orange
PCV-INSAA	PCV-INSAB	PCV-INSAC	—	—	Intrinsically Safe	Black/Orange
PCV-INTRA	PCV-INTRB	PCV-INTRC	—	—	Intrinsic Safety Wiring	Black/Orange
PCV-LTSA	PCV-LTSB	PCV-LTSC	—	—	Lights	Black/Orange
PCV-L/PA	PCV-L/PB	PCV-L/PC	—	—	Light & Power	Black/Orange
PCV-MAINA	PCV-MAINB	PCV-MAINC	—	—	Main	Black/Orange
PCV-OOA	PCV-OOB	PCV-OOC	—	—	On/Off	Black/Orange
PCV-PWRA	PCV-PWRB	PCV-PWRC	—	—	Power	Black/Orange
PCV-1PHA	PCV-1PHB	PCV-1PHC	—	—	Single Phase	Black/Orange
PCV-SPAREA	PCV-SPAREB	PCV-SPAREC	—	—	Spare	Black/Orange
PCV-TELEA	PCV-TELEB	PCV-TELEC	—	—	Telephone	Black/Orange
PCV-3PHA	PCV-3PHB	PCV-3PHC	—	—	Three Phase	Black/Orange

†Most legends also available in Spanish and Portuguese. To order, add part number suffix -E for Spanish or -P for Portuguese

Voltage and Ampere Markers















- Durable vinyl cloth markers
- Black legend on yellow background

Style	Marker Size Width x Length In. (mm)	Markers Per Card
A	8.98 x 2.24 (228.0 x 57.0)	1
B	4.49 x 1.02 (114.0 x 26.0)	4
C	2.24 x 0.51 (57.0 x 13.0)	18
D	1.12 x 0.51 (28.5 x 13.0)	36
F	0.75 x 0.35 (19.0 x 9.0)	48

Part Number					Legend	Color (Legend/Bkrnd)	Material	Std. Pkg. Qty.*
Style A	Style B	Style C	Style D	Style F				
PESC-A-5V	PESC-B-5V	PESC-C-5V	PESC-D-5V	—	5 Volt	Black/Yellow	GMC1 Vinyl Cloth	5 Cards
PESC-A-6V	PESC-B-6V	PESC-C-6V	PESC-D-6V	—	6 Volt			
PESC-A-12V	PESC-B-12V	PESC-C-12V	PESC-D-12V	—	12 Volt			
PESC-A-24V	PESC-B-24V	PESC-C-24V	PESC-D-24V	—	24 Volt			
PESC-A-48V	PESC-B-48V	PESC-C-48V	PESC-D-48V	—	48 Volt			
PESC-A-60V	PESC-B-60V	PESC-C-60V	PESC-D-60V	—	60 Volt			
PESC-A-110V	PESC-B-110V	PESC-C-110V	PESC-D-110V	—	110 Volt			
PESC-A-220V	PESC-B-220V	PESC-C-220V	PESC-D-220V	—	220 Volt			
PESC-A-230V	PESC-B-230V	PESC-C-230V	PESC-D-230V	—	230 Volt			
PESC-A-240V	PESC-B-240V	PESC-C-240V	PESC-D-240V	—	240 Volt			
PESC-A-380V	PESC-B-380V	PESC-C-380V	PESC-D-380V	—	380 Volt			
PESC-A-400V	PESC-B-400V	PESC-C-400V	PESC-D-400V	—	400 Volt			
PESC-A-440V	PESC-B-440V	PESC-C-440V	PESC-D-440V	—	440 Volt			
PESC-A-500V	PESC-B-500V	PESC-C-500V	PESC-D-500V	—	500 Volt			
PESC-A-600V	PESC-B-600V	PESC-C-600V	PESC-D-600V	—	600 Volt			
—	—	—	—	PESC-F-L1	L1			
—	—	—	—	PESC-F-L2	L2			
—	—	—	—	PESC-F-L3	L3			
—	—	—	—	PESC-F-N	N			
—	—	—	—	PESC-F-LPLS	L+			
—	—	—	—	PESC-F-LMIN	L-			
—	—	—	—	PESC-F-M	M			
—	—	—	—	PESC-F-AC	AC			
—	—	—	—	PESC-F-DC	DC			
—	—	—	—	PESC-F-ON	On			
—	—	—	—	PESC-F-OFF	Off			
—	—	—	—	PESC-F-VOLT	Volt			
—	—	—	—	PESC-F-2A	2A			
—	—	—	—	PESC-F-4A	4A			
—	—	—	—	PESC-F-6A	6A			
—	—	—	—	PESC-F-10A	10A			
—	—	—	—	PESC-F-16A	16A			
—	—	—	—	PESC-F-25A	25A			
—	—	—	—	PESC-F-35A	35A			
—	—	—	—	PESC-F-50A	50A			
—	—	—	—	PESC-F-63A	63A			
—	—	—	—	PESC-F-75A	75A			

*Order number of cards required in multiples of Std. Pkg. Qty.

Electrical Symbols

Part Number	Legend	Description	Marker Size Width x Length In. (mm)	Markers Per Card	Color (Legend/ Background)	Material	Std. Pkg. Qty.*
PESC-H-PE PESC-J-PE		Protective Conductor	0.51 x 0.51 (13.0 x 13.0) 0.75 x 0.75 (19.0 x 19.0)	60 36	Black/Yellow	GMC1 Vinyl Cloth	10 Cards
PESC-H-PU PESC-J-PU		Protective Conductor No Earth	0.51 x 0.51 (13.0 x 13.0) 0.75 x 0.75 (19.0 x 19.0)	60 36			
PESC-H-PEN PESC-J-PEN		Neutral Conductor with Protective-Function (PEN conductor)	0.51 x 0.51 (13.0 x 13.0) 0.75 x 0.75 (19.0 x 19.0)	60 36			
PESC-H-N PESC-J-N		Neutral Conductor	0.51 x 0.51 (13.0 x 13.0) 0.75 x 0.75 (19.0 x 19.0)	60 36			
PESC-H-EC PESC-J-EC		Safety Function	0.51 x 0.51 (13.0 x 13.0) 0.75 x 0.75 (19.0 x 19.0)	60 36			
PESC-H-E PESC-J-E		Earth (Ground)	0.51 x 0.51 (13.0 x 13.0) 0.75 x 0.75 (19.0 x 19.0)	60 36			
PESC-H-DT PESC-J-DT		Splash Proof Against Splashes from All Directions (per DIN 40050 Part 2)	0.51 x 0.51 (13.0 x 13.0) 0.75 x 0.75 (19.0 x 19.0)	60 36			
PESC-H-AT PESC-J-AT		Warning of Dangerous Electrical Voltage	0.51 x 0.51 (13.0 x 13.0) 0.75 x 0.75 (19.0 x 19.0)	60 36			
PESC-H-LT PESC-J-LT		Warning of Laser Beam	0.51 x 0.51 (13.0 x 13.0) 0.75 x 0.75 (19.0 x 19.0)	60 36			
PESC-H-HT PESC-J-HT		Static Sensitive Device; Handling Precautions Required	0.51 x 0.51 (13.0 x 13.0) 0.75 x 0.75 (19.0 x 19.0)	60 36			
PESC-H-BT PESC-J-BT		Warning of Battery Hazards	0.51 x 0.51 (13.0 x 13.0) 0.75 x 0.75 (19.0 x 19.0)	60 36			
PESC-H-SI PESC-J-SI		Protective Isolation	0.51 x 0.51 (13.0 x 13.0) 0.75 x 0.75 (19.0 x 19.0)	60 36			

*Order number of cards required in multiples of Std. Pkg. Qty.

Electrical / Voltage / Fiber Optic

Warning Labels

- Pre-titled labels used for industrial and electrical applications on product, packages or facilities to warn or inform
- Eliminate hazardous situations and create safe work environments

Choose the legend and style that suits your informational needs:



Individual Labels in Packages and Roll Mounted Labels

- Available in paper and indoor/outdoor vinyl materials
- Choose from a wide variety of stock legends
- Sold by the package or roll



PLD Dispenser Labels

- Packaged in a dispenser for label protection and your convenience
- Made of durable indoor vinyl film
- Choose from a wide variety of stock legends
- Sold by the dispenser

Warning Label Material Selection Guide

Material Code	Material	Temperature Range	Description	Color	Outdoor	Hazardous Environment	UL Rec.	CSA
—	Litho Paper	-65°F to 200°F (-54°C to 93°C)	Economical paper labels for indoor and temporary marking	White	No	No	No	No
GMM	Laminated Polyester	-40°F to 275°F (-40°C to 135°C)	Laminated material protects legend from abrasion and chemicals	White	Yes	Yes	No	No
GMP1	Destructible Paper	-65°F to 200°F (-54°C to 93°C)	Label will destruct upon removal; for permanent and tamper resistant labeling applications	White	No	No	No	No
GMV	Vinyl	-0°F to 170°F (-18°C to 77°C)	High quality indoor vinyl film; resists oil, water and solvents	White	No	No	Yes	Yes
GMV1	Vinyl	-40°F to 176°F (-40°C to 80°C)	Long lasting, general purpose vinyl film for indoor and outdoor marking	White	Yes (2 yrs)	No	No	No
GMV10L	Laminated Vinyl	-40°F to 225°F (-40°C to 107°C)	Laminated vinyl film for indoor/outdoor use; laminate protects legend from abrasion and chemicals	White, Yellow	Yes	Yes	No	No
GMV10	Destructible Vinyl	-65°F to 200°F (-54°C to 93°C)	Label will destruct upon removal; for permanent and tamper resistant labeling applications	White	Yes	No	No	No
GMV	Polyester	-40°F to 311°F (-40°C to 154°C)	Provides durability, high temperature resistance, and dimensional stability	White	Yes	Yes	Yes	Yes

Static Awareness Labels



WL1



WL3

Rolls

Part Number	Material	Legend	Color (Legend/Background)	Label Size Width x Length In. (mm)	Labels per Roll	Std. Pkg. Qty.*
WL1	Litho Paper	Static Awareness Warning	Black/Yellow	2.00 x 2.00 (50.8 x 50.8)	500	1 Roll
WL3	Litho Paper	Static Awareness Warning	Black/Yellow	2.00 x 2.00 (50.8 x 50.8)	500	

*Order number of rolls required in multiples of Std. Pkg. Qty.



PLD-49



PLD-58
MIL STD. 129J



PLD-33



PLD-60
EIA STD. 471



PLD-59
MIL and EIA

PLD Dispenser

Part Number	Material	Legend	Color (Legend/Background)	Label Size Width x Length In. (mm)	Labels per Dispenser	Std. Pkg. Qty.*
PLD-49	GMM Polyester	Anti-Static	Black/Yellow	1.50 x 1.00 (38.1 x 25.4)	200	1 Disp.
PLD-58	GMM Polyester	Static Awareness (MIL STD 129J)	Black/Yellow	1.50 x 1.00 (38.1 x 25.4)	200	
PLD-60	GMM Polyester	Static Awareness (EIA STD 471)	Black/Yellow	3.00 x 1.00 (76.2 x 25.4)	100	
PLD-59	GMM Polyester	Static Awareness (MIL STD and EIA)	Black/Yellow	3.00 x 1.00 (76.2 x 25.4)	100	
PLD-33	GMM Polyester	Caution Static Eliminators	Black/Yellow	1.50 x 1.00 (38.1 x 25.4)	200	

*Order number of dispensers required in multiples of Std. Pkg. Qty.

Electrical Labels



WL25



WL32
ISO 3864



WL33
ISO 3864

Individual Labels in Packages

Part Number	Material	Legend	Color (Legend/Background)	Label Size Width x Length In. (mm)	Labels per Pkg.	Std. Pkg. Qty.*
WL25	GMY Polyester	Warning...Lift & Lock	Black/Yellow	3.50 x 1.50 (88.9 x 38.1)	50	1 Pkg.
WL32	GMV1OL Vinyl	Caution Risk Of Electrical Shock Sym.	Black/Yellow	1.50 (38.1) Triangle	50	
WL33	GMV1OL Vinyl	Caution Risk Of Electrical Shock Sym.	Black/Yellow	4.50 (114.3) Triangle	50	

*Order number of packages required in multiples of Std. Pkg. Qty.



PLD-52
ISO 3864



PLD-82
NEC 210-4(d)



- PLD-36 Caution 120V
- PLD-44 Caution 208V
- PLD-37 Caution 220V
- PLD-45 Caution 230V
- PLD-38 Caution 240V
- PLD-46 Caution 277V
- PLD-47 Caution 277/480V
- PLD-48 Caution 380V
- PLD-39 Caution 440V
- PLD-40 Caution 460V



PLD-32



PLD-76
NEC 110.22



PLD-12



PLD-43

PLD Dispensers

Part Number	Material	Legend	Color (Legend/Background)	Label Size Width x Length In. (mm)	Labels per Dispenser	Std. Pkg. Qty.*
PLD-52	GMM Polyester	Attention Symbol	Black/Yellow	1.50 x 1.00 (38.1 x 25.4)	200	1 Disp.
PLD-82	GMM Polyester	Board Identification Circuit I.D.	Black/White	1.50 x 1.00 (38.1 x 25.4)	200	
PLD-36	GMM Polyester	Caution 120V	Black/Yellow	1.50 x 1.00 (38.1 x 25.4)	200	
PLD-44	GMM Polyester	Caution 208V	Black/Yellow	1.50 x 1.00 (38.1 x 25.4)	200	
PLD-37	GMM Polyester	Caution 220V	Black/Yellow	1.50 x 1.00 (38.1 x 25.4)	200	
PLD-45	GMM Polyester	Caution 230V	Black/Yellow	1.50 x 1.00 (38.1 x 25.4)	200	
PLD-38	GMM Polyester	Caution 240V	Black/Yellow	1.50 x 1.00 (38.1 x 25.4)	200	
PLD-46	GMM Polyester	Caution 277V	Black/Yellow	1.50 x 1.00 (38.1 x 25.4)	200	
PLD-47	GMM Polyester	Caution 277/480V	Black/Yellow	1.50 x 1.00 (38.1 x 25.4)	200	
PLD-48	GMM Polyester	Caution 380V	Black/Yellow	1.50 x 1.00 (38.1 x 25.4)	200	
PLD-39	GMM Polyester	Caution 440V	Black/Yellow	1.50 x 1.00 (38.1 x 25.4)	200	
PLD-40	GMM Polyester	Caution 460V	Black/Yellow	1.50 x 1.00 (38.1 x 25.4)	200	
PLD-32	GMM Polyester	Caution R.F. Voltage	Black/Yellow	1.50 x 1.00 (38.1 x 25.4)	200	
PLD-76	GMM Polyester	Caution Series Rated System	Black/Yellow	1.50 x 1.00 (38.1 x 25.4)	200	
PLD-12	GMM Polyester	Circuit No.	Orange/White	1.50 x 1.00 (38.1 x 25.4)	200	
PLD-43	GMM Polyester	Danger High Voltage	Red & Black/White	1.50 x 1.00 (38.1 x 25.4)	200	

*Order number of dispensers required in multiples of Std. Pkg. Qty.

Electrical Labels (cont.)



PLD-67
NEC 110-31



PLD-75
NEC 800



PLD-74



PLD-73
NEC 700.9A



PLD-79
NEC 760.4



PLD-70
NEC 210.8



PLD-57
ISO 3864



PLD-56
ISO 3864



PLD-80
NEC 504.80(b)



PLD-71
NEC 240.53



PLD-81
NEC 230.70(b)



PLD-69
NEC 210



PLD-54



PLD-53

PLD Dispensers (cont.)

Part Number	Material	Legend	Color (Legend/Background)	Label Size Width x Length In. (mm)	Labels per Dispenser	Std. Pkg. Qty.*	
PLD-67	GMM Polyester	Danger High Voltage	Red/White	1.00 x 1.50 (25.4 x 38.1)	200	1 Disp.	
PLD-75	GMM Polyester	Electrical Hazard	Red/White	1.50 x 1.00 (38.1 x 25.4)	200		
PLD-74	GMM Polyester	Electrical Shock Caution	Black/Yellow	1.50 x 1.00 (38.1 x 25.4)	200		
PLD-73	GMM Polyester	Emergency Systems	Red/White	1.50 x 1.00 (38.1 x 25.4)	200		
PLD-79	GMM Polyester	Fire Protective Signaling	Red/White	1.50 x 1.00 (38.1 x 25.4)	200		
PLD-70	GMM Polyester	Ground Fault Protected	Black/Clear	1.00 x 0.38 (25.4 x 9.5)	800		
PLD-57	GMM Polyester	N.E.C. Ground Symbol	Green/White	0.75 (19.1) Diameter	300		
PLD-56	GMM Polyester	International High Voltage Symbol	Black/Yellow	1.50 x 1.00 (38.1 x 25.4)	200		
PLD-80	GMM Polyester	Intrinsically Safe Wiring	Light Blue/White	1.50 x 1.00 (38.1 x 25.4)	200		
PLD-71	GMM Polyester	Warning For Continued Protection...Use Same Fuse	White/Black	2.00 x 1.00 (50.8 x 25.4)	150		
PLD-81	GMM Polyester	Service Disconnect	Black/White	1.50 x 1.00 (38.1 x 25.4)	200		
PLD-69	GMM Polyester	This Outlet Controlled By Wall Switch	Black/Clear	1.00 x 0.38 (25.4 x 9.5)	800		
FRENCH							
PLD-54	GMM Polyester	Danger Haute Tension	Red & Black/White	1.50 x 1.00 (38.1 x 25.4)	200		1 Disp.
SPANISH							
PLD-53	GMM Polyester	Peligro Alto Voltaje	Red & Black/White	1.50 x 1.00 (38.1 x 25.4)	200	1 Disp.	

*Order number of dispensers required in multiples of Std. Pkg. Qty.

Hot Surface Warning Labels



WL35



WL36

Individual Labels in Packages

Part Number	Material	Legend	Color (Legend/Background)	Label Size Width x Length In. (mm)	Labels per Pkg	Std. Pkg. Qty.*
WL35	GMV1OL Vinyl	Caution Hot Surface Warning Symbol	Black/Yellow	2.00 (50.8) Triangle	50	1 Pkg
WL36	GMV1OL Vinyl	Warning Hot Surface Warning Symbol	Black/Yellow	2.00 (50.8) Triangle	50	1 Pkg

*Order number of packages required in multiples of Std. Pkg. Qty.

Packaging / Shipping Labels



PLD-83

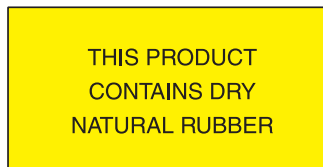

PLD-84



PLD-85



PLD-86

PLD Dispensers

Part Number	Material	Legend	Color (Legend/Background)	Label Size Width x Length In. (mm)	Labels per Dispenser	Std. Pkg. Qty.*
PLD-83	GMM Polyester	Product Contains Natural Rubber	Black/Yellow	2.00 x 1.00 (50.8 x 25.4)	150	1 Disp.
PLD-84	GMM Polyester	Product Contains Dry Natural Rubber	Black/Yellow	2.00 x 1.00 (50.8 x 25.4)	150	
PLD-85	GMM Polyester	Packaging Contains Natural Rubber	Black/Yellow	2.00 x 1.00 (50.8 x 25.4)	150	
PLD-86	GMM Polyester	Packaging Contains Dry Natural Rubber	Black/Yellow	2.00 x 1.00 (50.8 x 25.4)	150	

*Order number of dispensers required in multiples of Std. Pkg. Qty.

ISO Labels — Warning Symbols

- The International Organization for Standardization (ISO) has established a system to communicate safety information without the use of words. This is accepted in most countries worldwide. Colors and shapes recognizable worldwide are prescribed.
ISO symbology for "Caution" or "Risk of Danger" is a triangle (using black and yellow as its primary colors) to denote "WARNING." The 11 symbols below are those generally accepted as usable without supplementary signs to explain the essence of the message.
- Ref. ISO 3864 (DIN 40008, DIN 4844)

Part Number	Legend	Description	Triangular Length In. (mm)	Markers Per Card	Material	Std. Pkg. Qty.*
PESW-A-1 PESW-B-1 PESW-C-1 PESW-D-1 PESW-E-1		Warning of dangerous electrical voltage	0.49 (12.5) 0.98 (25.0) 1.97 (50.0) 3.94 (100.0) 7.87 (200.0)	10 10 10 3 1	GMV10L Laminated Vinyl	10 Cards
PESW-A-2 PESW-B-2 PESW-C-2 PESW-D-2 PESW-E-2		Warning of flammable materials	0.49 (12.5) 0.98 (25.0) 1.97 (50.0) 3.94 (100.0) 7.87 (200.0)	10 10 10 3 1		
PESW-A-3 PESW-B-3 PESW-C-3 PESW-D-3 PESW-E-3		Warning of explosive materials	0.49 (12.5) 0.98 (25.0) 1.97 (50.0) 3.94 (100.0) 7.87 (200.0)	10 10 10 3 1		
PESW-A-4 PESW-B-4 PESW-C-4 PESW-D-4 PESW-E-4		Warning of toxic materials	0.49 (12.5) 0.98 (25.0) 1.97 (50.0) 3.94 (100.0) 7.87 (200.0)	10 10 10 3 1		
PESW-A-5 PESW-B-5 PESW-C-5 PESW-D-5 PESW-E-5		Warning of acids	0.49 (12.5) 0.98 (25.0) 1.97 (50.0) 3.94 (100.0) 7.87 (200.0)	10 10 10 3 1		
PESW-A-6 PESW-B-6 PESW-C-6 PESW-D-6 PESW-E-6		Warning of radio-active materials or ionizing rays	0.49 (12.5) 0.98 (25.0) 1.97 (50.0) 3.94 (100.0) 7.87 (200.0)	10 10 10 3 1		
PESW-A-7 PESW-B-7 PESW-C-7 PESW-D-7 PESW-E-7		Warning of battery hazards	0.49 (12.5) 0.98 (25.0) 1.97 (50.0) 3.94 (100.0) 7.87 (200.0)	10 10 10 3 1		
PESW-A-8 PESW-B-8 PESW-C-8 PESW-D-8 PESW-E-8		Warning of laser-beam	0.49 (12.5) 0.98 (25.0) 1.97 (50.0) 3.94 (100.0) 7.87 (200.0)	10 10 10 3 1		
PESW-A-9 PESW-B-9 PESW-C-9 PESW-D-9 PESW-E-9		Warning of hazardous area	0.49 (12.5) 0.98 (25.0) 1.97 (50.0) 3.94 (100.0) 7.87 (200.0)	10 10 10 3 1		
PESW-A-10 PESW-B-10 PESW-C-10 PESW-D-10 PESW-E-10		Warning of explosive atmosphere	0.49 (12.5) 0.98 (25.0) 1.97 (50.0) 3.94 (100.0) 7.87 (200.0)	10 10 10 3 1		
PESW-A-11 PESW-B-11 PESW-C-11 PESW-D-11 PESW-E-11		Warning of static sensitive device	0.49 (12.5) 0.98 (25.0) 1.97 (50.0) 3.94 (100.0) 7.87 (200.0)	10 10 10 3 1		

*Order number of cards required in multiples of Std. Pkg. Qty.

ISO Labels — Prohibition Signs

- The circle denotes a prohibition or mandatory action. The following symbols in red, white and black prohibit certain behavior.
- Ref. ISO 3864 (DIN 40008, DIN 4844)

Part Number	Symbol	Description	Marker Diameter In. (mm)	Markers Per Card	Material	Std. Pkg. Qty.*
PESV-C-1 PESV-D-1 PESV-E-1		Do not throw switch	1.97 (50.0) 3.94 (100.0) 7.87 (200.0)	5 1 1	GMV10L Laminated Vinyl	10 Cards
PESV-C-2 PESV-D-2 PESV-E-2		Do not touch	1.97 (50.0) 3.94 (100.0) 7.87 (200.0)	5 1 1		
PESV-C-3 PESV-D-3 PESV-E-3		No smoking	1.97 (50.0) 3.94 (100.0) 7.87 (200.0)	5 1 1		
PESV-C-4 PESV-D-4 PESV-E-4		No fires or open flames	1.97 (50.0) 3.94 (100.0) 7.87 (200.0)	5 1 1		
PESV-C-5 PESV-D-5 PESV-E-5		Pedestrians prohibited	1.97 (50.0) 3.94 (100.0) 7.87 (200.0)	5 1 1		
PESV-C-6 PESV-D-6 PESV-E-6		No admittance	1.97 (50.0) 3.94 (100.0) 7.87 (200.0)	5 1 1		

*Order number of cards required in multiples of Std. Pkg. Qty.

ISO Labels — Mandatory Labels

- The below symbol denotes a mandatory action without the use of words. The most common mandatory action in the Electrical Industry is to insure the electrical supply is switched off.
- Ref. ISO3864 (DIN 40008 and Further Developments)

Part Number	Symbol	Description	Marker Diameter In. (mm)	Markers Per Card	Material	Std. Pkg. Qty.*
PESG-A-1 PESG-B-1 PESG-C-1 PESG-D-1		Switch off electrical supply before working on equipment	0.49 (12.5) 0.98 (25.0) 1.97 (50.0) 3.94 (100.0)	10 10 5 1	GMV10L Laminated Vinyl	10 Cards

*Order number of cards required in multiples of Std. Pkg. Qty.

Quality / Inspection / Production Control Labels and Tags



Calibration Labels

- Easy write-on surface
- Available in card, book and roll format
- Self-laminating markers available to provide legend protection



Quality Assurance Labels and Tags

- Easy write-on surface
- Available in card and dispenser format
- Wide variety of legends and sizes
- Fluorescent material available for high visibility



Inspection Labels and Tags

- Offered in a variety of legends for recording inspections, services of eye wash stations, fire extinguishers and machinery
- Dated inspection plates and DIN 40010 symbol signs available
- Inspection arrows and marker dots in a variety of colors



Production Control Tags

- For organizing inventory, quality control, OEM and maintenance applications
- Economical card stock tags for indoor or temporary use
- Also available in fluorescent card stock material for high visibility

Material Selection Guide

Material Code	Material Type	Temperature Range	Key Features	Color	Outdoor Rated	Hazardous Environment	UL Rec	CSA
GMC1	Vinyl Cloth	-40°F to 180°F (-40°C to 82°C)	General purpose wire marker material; resists oil and abrasion; can be removed and reused	White Yellow	No	No	No	No
GMP1	Destructible Paper	-65°F to 200°F (-54°C to 93°C)	Litho paper with destructible adhesive for permanent applications	White	No	No	No	No
GMM	Laminated Polyester	-40°F to 275°F (-40°C to 135°C)	Laminated material protects legend from abrasion and chemicals	White	Yes	Yes	No	No
GMV	Vinyl Film	0°F to 170°F (-18°C to 77°C)	Indoor vinyl film with write-on surface	White Yellow	No	No	Yes	Yes
GMV1	Vinyl Film	-40°F to 176°F (-40°C to 80°C)	General purpose indoor/outdoor vinyl film	White	Yes (2 years)	No	No	No
GMV5	Semi-Rigid Vinyl	-40°F to 150°F (-40°C to 66°C)	Non-adhesive vinyl tag stock with easy write-on surface	White Yellow	Yes (2 years)	No	No	No
GMV10	Destructible Vinyl	-65°F to 200°F (-54°C to 93°C)	Vinyl film with destructible adhesive for permanent application; breaks into pieces upon removal	White	Yes	No	No	No
GMV	Polyester	-40°F to 311°F (-40°C to 154°C)	Provides durability, high temperature resistance, and dimensional stability	White	Yes	Yes	Yes	Yes



Calibration Labels



- Mounted on cards for easy application and control of unused labels
- Easy write-on surface
- Durable indoor vinyl material resists oil and solvents and has permanent acrylic adhesive
- Ideal for small tools, gauges, etc.

Part Number	Material	Marker Size Width x Length In. (mm)	Markers Per Card	Std. Pkg. Qty.*
QL-*	GMV1 Vinyl	2.00 x 0.50 (50.8 x 12.7)	18	25 Cards

*Order number of cards required in multiples of Std. Pkg. Qty.

ACCEPTED / ACEPTADO
BY / POR _____ DATE / FECHA _____

QL-17

CALIBRATE BEFORE EACH USE

QL-8

CALIBRATE DAILY

QL-6

CALIBRATE MONTHLY

QL-3

CALIBRATE WEEKLY

QL-9

CALIBRATION / CALIBRACION
BY/POR _____ DATE/FECHA _____
DUE/VENUE _____ ID#/NO. ID. _____

QL-19RED†

CALIBRATION NOT REQUIRED

QL-4

CALIBRATION NOT REQUIRED NO REQUIERE CALIBRACION

QL-18

DEFECTIVE DO NOT USE

QL-13

DO NOT REMOVE FROM QC AREA

QL-11

INACTIVE
BY _____ DATE _____

QL-16

INVENTORY	
NO	DATE
COUNT	BY

QL-2

NOT IN CALIBRATION SYSTEM

QL-7

OUT OF CALIBRATION DO NOT USE
--

QL-10

OUT OF CALIBRATION DO NOT USE SIN CALIBRAR NO USAR

QL-20

PREVENTIVE MAINTENANCE
BY _____ DATE _____
NEXT MAINT. DATE _____

QL-15RED†

STANDARDIZE BEFORE EACH USE

QL-5

TOOL NO.
DEPT.

QL-12RED†

VERIFICATION
BY _____ DATE _____
DUE _____ I.D.# _____

QL-14RED†

†Other background colors available. To order, replace "RED" with "YEL" for yellow, "ORNG" for orange, "GRN" for green, "LTBLU" for light blue and "LTGRN" for light green.

Self-Laminating Calibration Labels



- Work well on small instruments
- Durable indoor vinyl material, with clear overlaminate provides easy write-on surface and protects the legend
- Permanent acrylic adhesive
- Choose from a variety of colors for multiple department or personnel identification

Marker Cards

Part Number	Legend	Write-On Area Color (Legend/Background)	Write-On Area Size W X L In. (mm)	Total Marker Size W X L In. (mm)	Markers Per Card	Material	Std. Pkg. Qty.*				
QL-21WHT	<table border="1"> <tr> <td>C</td> <td rowspan="7">ID# _____ BY _____ DATE _____ DUE _____</td> </tr> <tr> <td>A</td> </tr> <tr> <td>L</td> </tr> </table>	C	ID# _____ BY _____ DATE _____ DUE _____	A	L	Black/White	2.25 x 0.38 (57.1 x 9.5)	5.25 x 0.38 (133.4 x 9.5)	25	GMV3 Self-Lam Vinyl	10 Cards
C		ID# _____ BY _____ DATE _____ DUE _____									
A											
L											
QL-21YEL				Black/Yellow							
QL-21RED				Black/Red							
QL-21ORNG				Black/Orange							
QL-21GRN	Black/Green										
QL-21LTBLU	Black/Light Blue										
QL-21LTGRN	Black/Light Green										

*Order number of cards required in multiples of Std. Pkg. Qty.

Marker Books

Part Number	Legend	Write-On Area Color (Legend/Background)	Write-On Area Size W X L In. (mm)	Total Marker Size W X L In. (mm)	Markers Per Page	Pages Per Book	Material	Std. Pkg. Qty.*					
PSCB-3CAL	<table border="1"> <tr> <td>CALIBRATED</td> </tr> <tr> <td>NO: _____</td> </tr> <tr> <td>BY: _____</td> </tr> <tr> <td>DATE: _____</td> </tr> <tr> <td>DUE: _____</td> </tr> </table>	CALIBRATED	NO: _____	BY: _____	DATE: _____	DUE: _____	Green/White	1.00 x 0.75 (25.4 x 19.1)	1.00 x 3.00 (25.4 x 76.2)	6	10	GMV3 Self-Lam Vinyl	1 Book
CALIBRATED													
NO: _____													
BY: _____													
DATE: _____													
DUE: _____													
PSCB-6CAL	Green/White	1.00 x 1.00 (25.4 x 25.4)	1.00 x 6.00 (25.4 x 152.4)	3									

*Order number of books required in multiples of Std. Pkg. Qty.

Calibration Dots



- Ideal for small instruments used in hard to reach areas
- Durable indoor vinyl material provides easy write-on surface
- Permanent acrylic adhesive
- Used for quality control

Part Number	Legend	Color (Legend/Background)	Marker Diameter In. (mm)	Labels Per Roll	Material	Std. Pkg. Qty.*
QL-1WHT		Black/White	0.75 (19.1)	500	GMV1 Vinyl	1 Roll
QL-1YEL		Black/Yellow				
QL-1RED		Black/Red				
QL-1ORNG		Black/Orange				
QL-1GRN		Black/Green				
QL-1LTBLU		Black/Light Blue				
QL-1LTGRN		Black/Light Green				

*Order number of rolls required in multiples of Std. Pkg. Qty.

Write-On Labels on Cards



- For quality control, OEM, maintenance and field service applications
- Available in two sizes
- Mark with ball point pen or Panduit Marking Pens (see [pg. 137](#))

Part Number	Material	Marker Size Width x Length In. (mm)	Markers Per Card	Std. Pkg. Qty.*
PCWL-*	GMC1 Vinyl Cloth	1.50 x 0.63 (38.1 x 15.9)	14	25 Cards
PCWLL-*	GMC1 Vinyl Cloth	2.25 x 1.00 (57.2 x 25.4)	9	25 Cards

*Order number of cards required in multiples of Std. Pkg. Qty.

ACCEPTED	
BY _____	DATE _____

PCWL-ACC
PCWLL-ACC

BATCH NO.	DATE
_____	_____

PCWL-BN

CALIBRATED	
BY _____	DATE _____
DUE _____	

PCWL-CALD
PCWLL-CALD

CALIBRATION	
BY _____	DATE _____
DUE _____	

PCWL-CAL
PCWLL-CAL

CALIBRATION	
GUAGE NO. _____	
ACCURACY _____	
BY _____	DATE _____
DUE _____	

PCWL-VCAL

CALIBRATION	
BY _____	DATE _____
DUE _____	
GAGE ID _____	

PCWL-ICAL

CALIBRATION	
BY _____	DATE _____
DUE _____	
ID# _____	

PCWL-CALN
PCWLL-CALN

CAUTION	
---------	--

PCWL-CAU

CERTIFICATION	
BY _____	DATE _____
DUE _____	

PCWL-CER
PCWLL-CER

DATE INSTALLED	
BY _____	

PCWL-DI

DO NOT USE	
AFTER _____	

PCWL-DNU
PCWLL-DNU

DUE FOR INSPECTION	

DO NOT REMOVE	

PCWL-DFI

HOLD	
FOR _____	
UNTIL _____	

PCWL-HLD

HOLD FOR INSPECTION	
BY _____	DATE _____
REASON: _____	

PCWL-HFI

INSPECTED	
DATE _____	INITIALS _____

PCWL-INS
PCWLL-INS

MAINTENANCE	
BY _____	
DATE _____	

PCWL-MAIN
PCWLL-MAIN

QA APPROVED	
BY _____	
DATE _____	

PCWL-QA
PCWLL-QA

REJECTED		DATE
REASON _____		_____
	BY _____	

PCWL-REJ
PCWLL-REJ

RETURN TO VENDOR	
BY _____	DATE _____
REASON: _____	

PCWL-RTV

RE-WORK		DATE
BY: _____		_____
REASON: _____		

PCWL-RW

--

Part Number	Color
PCWLL-BL	White
PCWLL-BLB	Blue
PCWLL-BLG	Green
PCWLL-BLO	Orange
PCWLL-BLR	Red
PCWLL-BLY	Yellow

CALIBRATION	
BY _____	DATE _____
DUE JAN. _____	

Part Number	Month	Color
PCWL-CAL-JAN	JAN	Orange
PCWL-CAL-FEB	FEB	Black
PCWL-CAL-MAR	MAR	Light Blue
PCWL-CAL-APR	APR	Pink
PCWL-CAL-MAY	MAY	Gold
PCWL-CAL-JUN	JUN	Yellow
PCWL-CAL-JUL	JUL	Light Green
PCWL-CAL-AUG	AUG	Red
PCWL-CAL-SEP	SEP	Dark Blue
PCWL-CAL-OCT	OCT	Tan
PCWL-CAL-NOV	NOV	Dark Green
PCWL-CAL-DEC	DEC	Gray

Write-on Quality Labels in Dispenser



- Packaged in a dispenser for label protection and your convenience
- Made of durable laminated polyester film
- Other legends available — Static Awareness (see [page 162](#)) and Electrical (see [page 163](#))

Part Number	Material	Marker Size Width x Length In. (mm)	Markers Per Dispenser	Std. Pkg. Qty.*
PLD-*	GMM Laminated Polyester	1.50 x 1.00 (38.1 x 25.4)	200	1 Disp.

*Order number of dispensers required in multiples of Std. Pkg. qty.

ACCEPTED
BY _____
DATE _____

PLD-4

CALIBRATION
BY _____ DATE _____
DUE _____

PLD-22

CALIBRATION
BY _____ DATE _____
DUE _____

PLD-3

CAUTION

PLD-30

CAUTION
PINCH POINT

PLD-31

DO NOT USE
AFTER _____

PLD-11

DO NOT USE
UNTIL TESTED & CALIBRATED

PLD-42

EXPERIMENT
NO. _____
DATE _____ BY _____

PLD-5

HOLD FOR INSPECTION
DATE _____ BY _____
REASON _____

PLD-21

INVENTORY	
NO.	DATE
COUNT	BY

PLD-26

MAINTENANCE
BY _____
DATE _____

PLD-29

Q.C. CHECKED
BY _____
DATE _____

PLD-55

REJECTED
DATE _____ BY _____
REASON _____

PLD-8

REPAIRED BY
INITIALS _____
DATE _____

PLD-16

STOCK NO.

PLD-6

TESTED
DATE _____
BY _____

PLD-7

TOOL NO.	DEPT.

PLD-20

--

PLD-17

--

PLD-18



Fluorescent Paper Write-On Quality Labels

- Bright colors draw immediate attention and make sure important information is noticed
- Write-on surface can be marked with pencil, pen, or Panduit Permanent Marker Pens (see [pg. 137](#))

Part Number	Material	Marker Size Width x Length In. (mm)	Markers Per Sheet	Std. Pkg. Qty.*
QLF-*	GMP1 Paper	2.00 x 1.50 (50.8 x 38.1)	28	500

*Order number of markers required in multiples of Std. Pkg. Qty.



QLF-ACC



QLF-BATCH



QLF-BIN

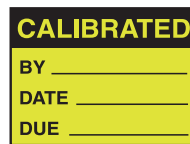

QLF-CALD

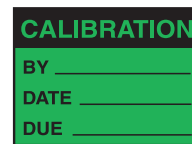

QLF-CALN

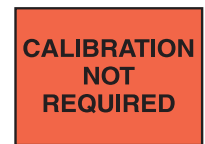

QLF-CNR



QLF-CAU



QLF-CERT

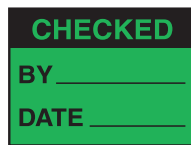

QLF-CHK



QLF-DATE

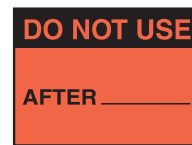

QLF-DNU



QLF-DUE



QLF-HBC



QLF-HOLD



QLF-INS



QLF-INV



QLF-MAIN



QLF-PACK

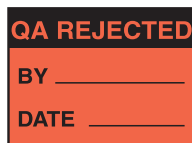

QLF-QA



QLF-RE



QLF-REJ



QLF-REP



QLF-SER



QLF-SHELF



QLF-STOCK



QLF-TEST



QLF-BLANK



Quality Control Action Tags



Attach tag to indicate action to be taken

- Unique labels and tags identify the “before and after” of eight common workplace actions
- Ideal for documents, machinery, small parts, bins and more
- Tags feature a perforation so user can tear off the lower portion of the tag once the status has been changed
- Economical card stock tags for indoor or temporary use
- Package consists of 25 tags and 25 Panduit PLT1.5I Cable Ties (5.6" / 142 mm length)

Part Number	Size W X L In. (mm)	Tags Per Pkg.	Std. Pkg. Qty.*
PCT-***-Q	5.75 x 3.00 (146.1 x 76.2)	25	1 Pkg.

*Order number of packages required in multiples of Std. Pkg. Qty.



Sign tag and tear at perforation once the status has changed



PCT-211-Q



PCT-205-Q



PCT-208-Q



PCT-204-Q

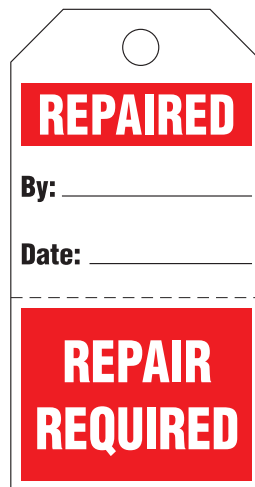

PCT-207-Q



PCT-206-Q

PANDUIT® PAN-CODE™ Inspection Labels and Tags



Inspection Labels and Tags



- Ideal for recording inspections, services of eye wash stations, fire extinguishers and machinery
- Tags are made of economical card stock material for indoor use and are supplied with Panduit PLT1.5I Cable Ties (5.6" / 142 mm length)
- Labels are made of self-adhesive paper for easy application

Part Number	Type	Material	Size Width x Length In. (mm)	Qty. Per Package	Std. Pkg. Qty.*
PCT-***-Q	Tag	GMV5 Rigid Plastic	3.00 x 5.75 (76.2 x 146.05)	25	1 Pkg.
PES-**-Q	Label	Paper	3.00 x 5.00 (76.2 x 127.0)	25	1 Pkg.

*Order number of packages required in multiples of Std. Pkg. Qty.

EYE WASH STATION INSPECTION
REPLACE WATER / 6 MOS.

DATE	WATER CHANGED YES / NO	STATION CLEANED YES / NO	INITIALS

PCT-126-Q
PES-L1-Q

EYEWASH/SOWER INSPECTION RECORD

Equipment ID _____
Location _____

Test

Date	Initials	Comments

PCT-141-Q

FIRE EXTINGUISHER INSPECTION

Last Hydro. Test or Purchase Date _____
Inspection good for 1 year from date shown.

Inspection Record

Date	Initials

**Consult extinguisher instructions for service recommendations. Contact service company.

PCT-127-Q
PES-L7-Q

FORKLIFT INSPECTION

Date: Tires Lift / Lower System Battery Directional/Speed Control

Initials: Steering Emerg. Disconnect Controls Hour Meter Horn Brakes Options

Comments: _____

PCT-144-Q
PES-L5-Q

INSPECTION RECORD

Equipment ID _____
Location _____

DATE	BY	REMARKS

DO NOT REMOVE TAG

PCT-128-Q
PES-L2-Q

INSPECTION / TEST RECORD

Equipment ID _____
Location _____

Test

Date	By	Results

PCT-216-Q
PES-L3-Q

SERVICE RECORD

Equipment ID _____
Location _____

DATE	BY	SERVICE PERFORMED

PCT-143-Q
PES-L6-Q

SERVICE RECORD

Equipment ID _____
Location _____

Last Service Date	By	Next Service Date

PCT-217-Q
PES-L4-Q

VALVE INSPECTION

Valve ID _____
Location _____

DATE	BY	RESULTS

PCT-142-Q



Inspection Plates

- The ideal system for fast recognition of inspection intervals and maintenance dates for safety testing
- Label is destroyed upon removal
- Available for different years and in 7 languages where text is included

Part Number	Legend	Year	Color (Legend/Background)	Marker Diameter In. (mm)	Markers Per Card	Material	Std. Pkg. Qty.*
PEIP-A-00 PEIP-A-01 PEIP-A-02 PEIP-A-03 PEIP-A-04		00 01 02 03 04	White/Violet White/Green White/Blue White/Red White/Brown	0.59 (15.0)	10	GMV10 Destructible Vinyl	10 Cards
PEIP-A-BL PEIP-A-BR PEIP-A-GR PEIP-A-OR PEIP-A-VI PEIP-A-YL		—	White/Blue White/Brown White/Green White/Orange White/Violet White/Yellow	0.59 (15.0)	10		
PEIP-C-03† PEIP-C-04†		98 thru 03 99 thru 04	Black/Yellow	1.18 (30.0)	5		
PEIP-C-03-2† PEIP-C-04-2†		98 thru 03 99 thru 04	Black/Yellow	1.18 (30.0)	5		
PEIP-D-00 PEIP-D-01 PEIP-D-02 PEIP-D-03 PEIP-D-04		00 01 02 03 04	White/Violet White/Green White/Blue White/Red White/Brown	1.38 (35.0)	5		

*Order number of cards required in multiples of Std. Pkg. Qty.

†Also available in German, French, Italian, Dutch, Spanish, and Portuguese. Contact factory for part numbers.

Inspection Signs

- Ref. DIN 40010

Part Number	Legend	Description	Color (Legend/Background)	Marker Height In. (mm)	Markers Per Card	Material	Std. Pkg. Qty.*
PESS-A-VDE1 PESS-B-VDE1 PESS-C-VDE1 PESS-D-VDE1 PESS-E-VDE1		VDE-Sign	Black/White	0.49 (12.5) 0.63 (16.0) 0.79 (20.0) 0.98 (25.0) 1.24 (31.5)	20 20 10 10 10	Polyester	10 Cards
PESS-A-VDE2 PESS-B-VDE2 PESS-C-VDE2 PESS-D-VDE2 PESS-E-VDE2		VDE-Spark Protection Sign	Black/White	0.49 (12.5) 0.63 (16.0) 0.79 (20.0) 0.98 (25.0) 1.24 (31.5)	20 20 10 10 10		
PESS-A-VDE3 PESS-B-VDE3 PESS-C-VDE3 PESS-D-VDE3 PESS-E-VDE3		VDE-Electronic certificate	Black/White	0.49 (12.5) 0.63 (16.0) 0.79 (20.0) 0.98 (25.0) 1.24 (31.5)	20 20 10 10 10		
PESS-A-CECC PESS-B-CECC PESS-C-CECC PESS-D-CECC PESS-E-CECC		CEE certificate	Black/White	0.49 (12.5) 0.63 (16.0) 0.79 (20.0) 0.98 (25.0) 1.24 (31.5)	20 20 10 10 10		
PESS-A-GS1 PESS-B-GS1 PESS-C-GS1 PESS-D-GS1 PESS-E-GS1		VDE-GS-Symbol	Black/White	0.49 (12.5) 0.63 (16.0) 0.79 (20.0) 0.98 (25.0) 1.24 (31.5)	20 20 10 10 10		
PESS-A-GS2 PESS-B-GS2 PESS-C-GS2 PESS-D-GS2 PESS-E-GS2		VDE-GS-Symbol	Black/White	0.49 (12.5) 0.63 (16.0) 0.79 (20.0) 0.98 (25.0) 1.24 (31.5)	20 20 10 10 10		

*Order number of cards required in multiples of Std. Pkg. Qty.



Inspection Arrows

Part Number	Color (Legend/Background)	Marker Size W X L In. (mm)	Material	Markers Per Card	Std. Pkg. Qty.*
PARW125-RED	Black/Red	0.13 x 0.19 (3.2 x 4.7)	GMC1 Vinyl Cloth	576	25 Cards
PARW125-YEL	Black/Yellow				
PARW125-WHT	Black/White				

*Order number of cards required in multiples of Std. Pkg. Qty.



Marker Dots on Cards

Part Number	NEMA Color	Marker Diameter In. (mm)	Material	Markers Per Card	Std. Pkg. Qty.*
PDOT25-BLK	Black	0.25 (6.4)	GMV1 Vinyl	144	25 Cards
PDOT25-BLU	Blue				
PDOT25-DGN	Dark Green				
PDOT25-GRY	Gray				
PDOT25-LGN	Light Green				
PDOT25-ORN	Orange				
PDOT25-RED	Red				
PDOT25-WHT	White				
PDOT25-YEL	Yellow				

*Order number of cards required in multiples of Std. Pkg. Qty.



PLD-62



PLD-63



PLD-64



PLD-65



PLD-77



PLD-78

NEC 834-3(c)

Marker Dots in Dispenser

- Packaged in a dispenser for label protection and your convenience
- Made of durable laminated polyester film

Part Number	Material	Marker Diameter In. (mm)	Markers Per Dispenser	Std. Pkg. Qty.*
PLD-*	GMM Laminated Polyester	0.75 (19.1)	300	1 Disp.

*Order number of dispensers required in multiples of Std. Pkg. qty.



Production Control Tags

- For organizing inventory, quality control, OEM, and maintenance applications
- Economical card stock tags for indoor or temporary use
- Package consists of 25 tags and 25 Panduit PLT1.5I Cable Ties (5.6" / 142 mm length)

Part Number	Size W X L In. (mm)	Tags Per Pkg.	Std. Pkg. Qty.*
PCT-***-Q	5.75 x 3.00(146.1 x 76.2)	25	1 Pkg.

*Order number of packages required in multiples of Std. Pkg. Qty.

ACCEPTED

REMARKS _____

SIGNED BY _____ DATE _____

PCT-183-Q

CALIBRATED

REMARKS _____

SIGNED BY _____ DATE _____

PCT-184-Q

DUE FOR INSPECTION

REMARKS _____

SIGNED BY _____ DATE _____

PCT-185-Q

DUE FOR MAINTENANCE

REMARKS _____

SIGNED BY _____ DATE _____

PCT-186-Q

HOLD

REMARKS _____

SIGNED BY _____ DATE _____

PCT-187-Q

INSPECTED

REMARKS _____

SIGNED BY _____ DATE _____

PCT-188-Q

OK FOR SHIPMENT

REMARKS _____

SIGNED BY _____ DATE _____

PCT-189-Q

REJECTED

REMARKS _____

SIGNED BY _____ DATE _____

PCT-190-Q

REPAIR

REMARKS _____

SIGNED BY _____ DATE _____

PCT-191-Q

RETURN TO STOCK

REMARKS _____

SIGNED BY _____ DATE _____

PCT-192-Q

RETURN TO VENDOR

REMARKS _____

SIGNED BY _____ DATE _____

PCT-193-Q

RETURNED GOODS

REMARKS _____

SIGNED BY _____ DATE _____

PCT-83-Q

RE-WORK

REMARKS _____

SIGNED BY _____ DATE _____

PCT-194-Q

SAMPLE

REMARKS _____

SIGNED BY _____ DATE _____

PCT-195-Q

SCRAP

REMARKS _____

SIGNED BY _____ DATE _____

PCT-196-Q

SPECIAL INSTRUCTIONS

REMARKS _____

SIGNED BY _____ DATE _____

PCT-197-Q

TESTED

REMARKS _____

SIGNED BY _____ DATE _____

PCT-75-Q

TOP PRIORITY

REMARKS _____

SIGNED BY _____ DATE _____

PCT-91-Q

PCT-94-Q

PCT-95-Q



Fluorescent Tags



- Eye-catching colors draw immediate attention
- Communicate a variety of information quickly and effectively
- Economical card stock tags for indoor or temporary use
- Package consists of 25 tags and 25 Panduit PLT1.5I Cable Ties (5.6" / 142 mm length)

Part Number	Size W X L In. (mm)	Tags Per Pkg.	Std. Pkg. Qty.*
PCT-***-Q	5.75 x 3.00(146.1 x 76.2)	25	1 Pkg.

*Order number of packages required in multiples of Std. Pkg. Qty.



PCT-174F-Q



PCT-172F-Q



PCT-173F-Q

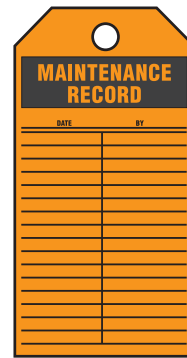

PCT-175F-Q



PCT-170F-Q

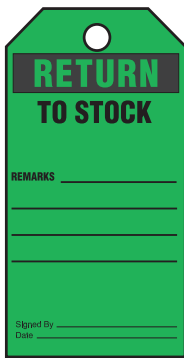

PCT-169F-Q

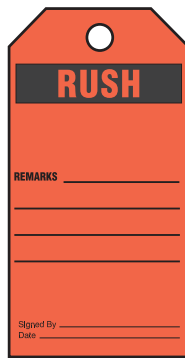

PCT-171F-Q



PCT-168F-Q



PCT-178F-Q



PCT-182F-Q



PCT-180F-Q



PCT-179F-Q

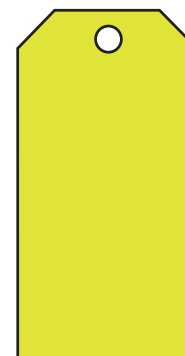

PCT-95F-Q

Blank Labels by Size

Label Size Width x Length In. (mm)	Material	Color	Print Method*	Part Number	Page No.
0.20 x 0.65 (5.1 x 16.5)	Polyester	White	IJ	JL32Y-10	55
0.20 x 0.65 (5.1 x 16.5)	Vinyl Cloth	White	IJ	JL32C-10	55
0.25 x 0.25 (6.4 x 6.4)	Polyester	White	L	PLL-30-Y2-10	75
0.25 x 0.25 (6.4 x 6.4)	Polyester	White	TT	TTC1Y-10	42
0.25 x 0.65 (6.4 x 16.5)	Polyester	White	IJ	JL4Y-10	55
0.25 x 0.75 (6.4 x 19.1)	Polyester	White	IJ	JL274Y-10	55
0.25 x 0.80 (6.4 x 20.3)	Polyester	White	IJ	JL5Y-10	55
0.25 x 0.90 (6.4 x 22.9)	Polyester	White	IJ	JL287Y-10	55
0.25 x 1.00 (6.4 x 25.4)	Destructible Paper	White	IJ	JL7P-10	55
0.25 x 1.00 (6.4 x 25.4)	Polyester	White	IJ	JL7Y-10	55
0.25 x 1.00 (6.4 x 25.4)	Polyolefin	White	IJ	JL7PO-10	55
0.25 x 1.44 (6.4 x 36.6)	Polyester	White	DM	PDL-177	112
0.25 x 1.44 (6.4 x 36.6)	TEDLAR*	White	DM	PDL-179	112
0.25 x 1.44 (6.4 x 36.6)	Vinyl	White	DM	PDL-178	112
0.25 x 1.44 (6.4 x 36.6)	Vinyl Cloth	White	DM	PDL-176	112
0.25 x 1.50 (6.4 x 38.1)	Polyester	White	IJ	JL14Y-10	55
0.25 x 1.50 (6.4 x 38.1)	Polyolefin	White	IJ	JL14PO-10	55
0.25 x 1.50 (6.4 x 38.1)	Vinyl Cloth	White	IJ	JL14C-10	55
0.25 x 1.88 (6.4 x 47.6)	Polyester	White	IJ	JL15Y-10	55
0.28 x 0.25 (7.11 x 6.4)	Vinyl Cloth	White	DM	PDL-347	112
0.30 x 0.20 (7.6 x 5.1)	TEDLAR	White	DM	PDL-7966-10	112
0.30 x 0.25 (7.6 x 6.4)	Polyester	White	L	PLL-1-Y2-10	75
0.30 x 0.25 (7.6 x 6.4)	Polyester	Yellow	L	PLL-1-Y2Y-10	75
0.30 x 0.30 (7.6 x 7.6)	Polyester	White	DM	PDL-253	112
0.30 x 0.30 (7.6 x 7.6)	Polyester	White	DM	PDL-253-10	112
0.30 x 0.30 (7.6 x 7.6)	Polyimide	Amber	DM	PDL-252	112
0.30 x 0.30 (7.6 x 7.6)	Polyimide	Amber	DM	PDL-252-10	112
0.30 x 0.75 (7.6 x 19.1)	TEDLAR	White	DM	PDL-256	112
0.30 x 0.75 (7.6 x 19.1)	Vinyl Cloth	White	DM	PDL-254	112
0.30 x 0.94 (7.6 x 23.8)	TEDLAR	White	DM	PDL-259	112
0.30 x 0.94 (7.6 x 23.8)	Vinyl Cloth	White	DM	PDL-257	112
0.30 x 2.90 (7.6 x 73.7)	Polyolefin	White	IJ	JLEFPD-1	55
0.31 x 0.38 (7.87 x 9.5)	Vinyl Cloth	White	DM	PDL-351	112
0.31 x 0.50 (7.87 x 12.7)	Vinyl Cloth	White	DM	PDL-353	112
0.31 x 700 (7.87 x 17780)	Vinyl Cloth	White	DM	PDL-349	112
0.35 x 0.59 (9.0 x 15.0)	Polyester	Yellow	L	PEL-25-Y2Y-10	76
0.38 x 0.38 (9.5 x 9.5)	Destructible Vinyl	White	DM	PDL-263	112
0.38 x 0.38 (9.5 x 9.5)	Polyester	White	DM	PDL-264	112
0.38 x 0.38 (9.5 x 9.5)	Polyester	White	DM	PDL-264-10	112
0.38 x 0.38 (9.5 x 9.5)	Polyester	White	IJ	JL2Y-10	55
0.38 x 0.38 (9.5 x 9.5)	Polyester	White	L	PLL-2-Y2-10	72
0.38 x 0.38 (9.5 x 9.5)	Polyester	White	TT	TTC2Y-10	42
0.38 x 0.38 (9.5 x 9.5)	Polyester	Yellow	L	PLL-2-Y2Y-10	72
0.38 x 0.38 (9.5 x 9.5)	Polyimide	Amber	DM	PDL-262	112
0.38 x 0.38 (9.5 x 9.5)	Polyimide	Amber	DM	PDL-262-10	112
0.38 x 0.38 (9.5 x 9.5)	Vinyl Cloth	White	DM	PDL-260	112
0.38 x 1.00 (9.5 x 25.4)	Destructible Paper	White	IJ	JL8P-10	55
0.38 x 1.00 (9.5 x 25.4)	Polyester	White	IJ	JL8Y-10	55
0.38 x 1.00 (9.5 x 25.4)	Polyolefin	White	IJ	JL8PO-10	55
0.38 x 1.00 (9.5 x 25.4)	Vinyl Cloth	White	IJ	JL8C-10	55
0.38 x 1.44 (9.5 x 36.6)	Polyester	White	DM	PDL-181	112
0.38 x 1.44 (9.5 x 36.6)	TEDLAR	White	DM	PDL-183	112
0.38 x 1.44 (9.5 x 36.6)	Vinyl	White	DM	PDL-182	112

Label Size Width x Length In. (mm)	Material	Color	Print Method*	Part Number	Page No.
0.38 x 1.44 (9.5 x 36.6)	Vinyl Cloth	White	DM	PDL-180	112
0.38 x 1.88 (9.5 x 47.6)	Polyolefin	White	IJ	JL16PO-2.5	55
0.38 x 1.88 (9.5 x 47.6)	Polyester	White	IJ	JL16Y-5	55
0.38 x 2.00 (9.5 x 50.8)	Polyester	White	IJ	JL111Y-5	55
0.38 x 2.00 (9.5 x 50.8)	Vinyl Cloth	White	IJ	JL111C-5	55
0.38 x 3.00 (9.5 x 76.2)	Polyolefin	White	IJ	JL19PO-1	55
0.38 x 3.00 (9.5 x 76.2)	Polyester	White	IJ	JL19Y-2.5	55
0.38 x 700 (9.5 x 17780)	Vinyl Cloth	White	DM	PDL-355	112
0.43 x 0.75 (11.0 x 19.1)	Polyester	Yellow	L	PEL-26-Y2Y-5	76
0.43 x 1.50 (11.0 x 38.1)	Polyester	Yellow	L	PEL-27-Y2Y-5	76
0.44 x 2.56 (11.1 x 65.0)	Polyester	White	DM	PDL-101	112
0.44 x 2.56 (11.1 x 65.0)	TEDLAR	White	DM	PDL-100	112
0.44 x 2.56 (11.1 x 65.0)	Vinyl	White	DM	PDL-103	112
0.44 x 2.56 (11.1 x 65.0)	Vinyl Cloth	White	DM	PDL-102	112
0.44 x 3.63 (11.1 x 92.1)	Polyester	White	DM	PDL-105	113
0.44 x 3.63 (11.1 x 92.1)	TEDLAR	White	DM	PDL-104	113
0.44 x 3.63 (11.1 x 92.1)	Vinyl	White	DM	PDL-107	113
0.44 x 3.63 (11.1 x 92.1)	Vinyl Cloth	White	DM	PDL-106	113
0.44 x 3.63 (11.1 x 92.1)	Vinyl Cloth	White	DM	PDL-106-1	113
0.44 x 3.63 (11.1 x 92.1)	Vinyl Cloth	White	DM	PDL-106-10	113
0.50 x 0.44 (12.7 x 11.1)	Destructible Vinyl	White	DM	PDL-46	113
0.50 x 0.44 (12.7 x 11.1)	Polyester	Silver	DM	PDL-48	113
0.50 x 0.44 (12.7 x 11.1)	Polyester	Silver	DM	PDL-48-1	113
0.50 x 0.44 (12.7 x 11.1)	Polyester	Silver	DM	PDL-48-10	113
0.50 x 0.44 (12.7 x 11.1)	Polyester	Silver	TT	TTC3YS-10	42
0.50 x 0.44 (12.7 x 11.1)	Polyester	White	DM	PDL-47	113
0.50 x 0.44 (12.7 x 11.1)	Polyester	White	DM	PDL-47-10	113
0.50 x 0.44 (12.7 x 11.1)	Polyester	White	L	PLL-31-Y2-10	72
0.50 x 0.44 (12.7 x 11.1)	Polyester	White	TT	TTC3Y-10	42
0.50 x 0.44 (12.7 x 11.1)	Removable Paper	White	DM	PDL-91	113
0.50 x 0.44 (12.7 x 11.1)	Removable Polyolefin	White	L	PLL-31-POR-10	72
0.50 x 0.44 (12.7 x 11.1)	Tamp. Evid. Polyester	Silver	TT	TTC3YST-10	42
0.50 x 0.44 (12.7 x 11.1)	Vinyl Cloth	White	DM	PDL-45	113
0.50 x 0.44 (12.7 x 11.1)	Vinyl Cloth	White	DM	PDL-45-1	113
0.50 x 0.44 (12.7 x 11.1)	Vinyl Cloth	White	DM	PDL-45-10	113
0.50 x 0.50 (12.7 x 12.7)	Polyester	Silver	L	PEL-9-Y1-10	76
0.50 x 0.50 (12.7 x 12.7)	Polyester	White	L	PEL-9-Y2-10	76
0.50 x 0.50 (12.7 x 12.7)	Tamp. Evid. Polyester	Silver	L	PEL-9-Y1C-10	76
0.50 x 0.75 (12.7 x 19.1)	Destructible Paper	White	DM	PDL-122	113
0.50 x 0.75 (12.7 x 19.1)	Destructible Paper	White	DM	PDL-89	113
0.50 x 0.75 (12.7 x 19.1)	Polyester	White	DM	PDL-121	113
0.50 x 0.75 (12.7 x 19.1)	Polyester	White	DM	PDL-90	113
0.50 x 0.75 (12.7 x 19.1)	Polyester	White	TT	TTC45Y-1	42
0.50 x 0.75 (12.7 x 19.1)	TEDLAR	White	DM	PDL-120	113
0.50 x 0.75 (12.7 x 19.1)	TEDLAR	White	DM	PDL-120-10	113
0.50 x 0.75 (12.7 x 19.1)	TEDLAR	White	DM	PDL-44	113
0.50 x 0.75 (12.7 x 19.1)	Vinyl Cloth	White	DM	PDL-119	113
0.50 x 0.75 (12.7 x 19.1)	Vinyl Cloth	White	DM	PDL-43	113
0.50 x 0.75 (12.7 x 19.1)	Vinyl Cloth	White	DM	PDL-43-10	113

* DM = Dot-Matrix, IJ = Ink Jet, L = Laser, TT = Thermal Transfer
 * TEDLAR is a registered trademark of E.I DuPont Co.

Blank Labels by Size (cont.)

Label Size Width x Length In. (mm)	Material	Color	Print Method*	Part Number	Page No.
0.50 x 0.80 (12.7 x 20.3)	Destructible Paper	White	IJ	JL172P-10	55
0.50 x 0.80 (12.7 x 20.3)	Polyester	White	IJ	JL172Y-10	55
0.50 x 0.94 (12.7 x 23.8)	TEDLAR ▲	White	DM	PDL-267	113
0.50 x 0.94 (12.7 x 23.8)	Vinyl Cloth	White	DM	PDL-269	113
0.50 x 1.00 (12.7 x 25.4)	Destructible Paper	White	IJ	JL9P-10	55
0.50 x 1.00 (12.7 x 25.4)	Polyester	White	IJ	JL9Y-10	55
0.50 x 1.00 (12.7 x 25.4)	Polyolefin	White	IJ	JL9PO-10	55
0.50 x 1.00 (12.7 x 25.4)	Vinyl Cloth	White	IJ	JL9C-10	55
0.50 x 1.44 (12.7 x 36.5)	Polyester	White	DM	PDL-14	113
0.50 x 1.44 (12.7 x 36.5)	Polyester	White	DM	PDL-14-10	113
0.50 x 1.44 (12.7 x 36.5)	Polyester	White	DM	PDL-185	113
0.50 x 1.44 (12.7 x 36.5)	TEDLAR	White	DM	PDL-187	113
0.50 x 1.44 (12.7 x 36.5)	Vinyl	White	DM	PDL-15	113
0.50 x 1.44 (12.7 x 36.5)	Vinyl	White	DM	PDL-186	113
0.50 x 1.44 (12.7 x 36.5)	Vinyl Cloth	White	DM	PDL-13	113
0.50 x 1.44 (12.7 x 36.5)	Vinyl Cloth	White	DM	PDL-13-1	113
0.50 x 1.44 (12.7 x 36.5)	Vinyl Cloth	White	DM	PDL-13-10	113
0.50 x 1.44 (12.7 x 36.5)	Vinyl Cloth	White	DM	PDL-184	113
0.50 x 1.44 (12.7 x 36.5) With Horizontal Slit	Destructible Paper	White	DM	PDL-138	114
0.50 x 1.44 (12.7 x 36.5) With Horizontal Slit	Polyester	White	DM	PDL-136	114
0.50 x 1.44 (12.7 x 36.5) With Horizontal Slit	TEDLAR	White	DM	PDL-137	114
0.50 x 1.44 (12.7 x 36.5) With Horizontal Slit	Vinyl Cloth	White	DM	PDL-135	114
0.50 x 1.50 (12.7 x 38.1)	Destructible Paper	White	IJ	JL12P-5	55
0.50 x 1.50 (12.7 x 38.1)	Polyester	White	IJ	JL12Y-5	55
0.50 x 1.50 (12.7 x 38.1)	Polyolefin	White	L	PLL-33-PO-5	72
0.50 x 7.88 (12.7 x 200.0)	Polyester	White	TT	TTC-DS110-1	42
0.56 x 0.19 (14.3 x 4.8)	Polyolefin	White	IJ	JL24PO-5	55
0.56 x 0.19 (14.3 x 4.8)	Polyester	Clear	DM	PDL-402-10	114
0.56 x 0.19 (14.3 x 4.8)	Polyester	Clear	DM	PDL-402-D	114
0.56 x 0.19 (14.3 x 4.8)	Polyester	Clear	L	PLL-24-Y3-1	72
0.56 x 0.19 (14.3 x 4.8)	Polyester	Clear	L	PLL-24-Y3-5	72
0.56 x 0.19 (14.3 x 4.8)	Polyester	White	DM	PDL-405-10	114
0.56 x 0.19 (14.3 x 4.8)	Polyester	White	DM	PDL-405-D	114
0.56 x 0.19 (14.3 x 4.8)	Polyester	White	L	PLL-24-Y2-1	72
0.56 x 0.19 (14.3 x 4.8)	Polyester	White	L	PLL-24-Y2-5	72
0.56 x 0.25 (14.3 x 6.4)	Polyester	Clear	L	PEL-29-Y3M-10	76
0.56 x 0.25 (14.3 x 6.4)	Polyester	White	L	PEL-29-Y2-10	76
0.56 x 0.56 (14.3 x 14.3)	Polyester	Clear	L	PEL-28-Y3M-5	76
0.56 x 0.56 (14.3 x 14.3)	Polyester	White	L	PEL-28-Y2-5	76
0.56 x 0.56 (14.3 x 14.3)	Polyester	Clear	DM	PDL-401	114
0.56 x 0.56 (14.3 x 14.3)	Polyester	Clear	DM	PDL-401-10	114
0.56 x 0.56 (14.3 x 14.3)	Polyester	Clear	DM	PDL-401-D	114
0.56 x 0.56 (14.3 x 14.3)	Polyester	Clear	L	PLL-23-Y3-1	72
0.56 x 0.56 (14.3 x 14.3)	Polyester	Clear	L	PLL-23-Y3-5	72
0.56 x 0.56 (14.3 x 14.3)	Polyester	Electrical Ivory	DM	PDL-400	114
0.56 x 0.56 (14.3 x 14.3)	Polyester	White	DM	PDL-406-10	114
0.56 x 0.56 (14.3 x 14.3)	Polyester	White	DM	PDL-406-D	114

Label Size Width x Length In. (mm)	Material	Color	Print Method*	Part Number	Page No.
0.56 x 0.56 (14.3 x 14.3)	Polyester	White	L	PLL-23-Y2-1	72
0.56 x 0.56 (14.3 x 14.3)	Polyester	White	L	PLL-23-Y2-5	72
0.56 x 0.56 (14.3 x 14.3)	Polyolefin	White	IJ	JL23PO-1	55
0.59 x 0.35 (15.0 x 9.0)	Vinyl Cloth	White	DM	PDL-194	114
0.59 x 0.35 (15.0 x 9.0)	Vinyl Cloth	Yellow	DM	PDL-193	114
0.61 x 0.33 (15.5 x 8.4)	Polyolefin	White	IJ	JLCPL-1	55
0.65 x 0.20 (16.5 x 5.1)	TEDLAR	White	TT	TTC4T-10	114
0.65 x 0.20 (16.5 x 5.1)	Destructible Paper	White	DM	PDL-82	114
0.65 x 0.20 (16.5 x 5.1)	Destructible Vinyl	White	DM	PDL-35	114
0.65 x 0.20 (16.5 x 5.1)	Destructible Vinyl	White	DM	PDL-35-1	114
0.65 x 0.20 (16.5 x 5.1)	Destructible Vinyl	White	DM	PDL-35-10	114
0.65 x 0.20 (16.5 x 5.1)	Polyester	Silver	DM	PDL-234	114
0.65 x 0.20 (16.5 x 5.1)	Polyester	Silver	DM	PDL-234-10	114
0.65 x 0.20 (16.5 x 5.1)	Polyester	White	DM	PDL-36	114
0.65 x 0.20 (16.5 x 5.1)	Polyester	White	DM	PDL-36-10	72
0.65 x 0.20 (16.5 x 5.1)	Polyester	White	L	PLL-32-Y2-10	42
0.65 x 0.20 (16.5 x 5.1)	Polyester	White	TT	TTC4Y-10	72
0.65 x 0.20 (16.5 x 5.1)	Polyester	Yellow	L	PLL-32-Y2Y-10	114
0.65 x 0.20 (16.5 x 5.1)	Polyimide	Amber	DM	PDL-233	114
0.65 x 0.20 (16.5 x 5.1)	Polyimide	Amber	DM	PDL-233-10	42
0.65 x 0.20 (16.5 x 5.1)	Tamp. Evid. Polyester	Silver	TT	TTC4YST-10	114
0.65 x 0.20 (16.5 x 5.1)	TEDLAR	White	DM	PDL-83	114
0.65 x 0.20 (16.5 x 5.1)	TEDLAR	White	DM	PDL-83-10	42
0.65 x 0.20 (16.5 x 5.1)	Vinyl	White	DM	PDL-189	114
0.65 x 0.20 (16.5 x 5.1)	Vinyl Cloth	White	DM	PDL-34	114
0.65 x 0.20 (16.5 x 5.1)	Vinyl Cloth	White	DM	PDL-34-1	114
0.65 x 0.20 (16.5 x 5.1)	Vinyl Cloth	White	DM	PDL-34-10	114
0.65 x 0.20 (16.5 x 5.1) With Tamper Resistant Slits	Polyester	White	DM	PDL-269	114
0.65 x 0.25 (16.5 x 6.4)	Polyester	White	L	PLL-4-Y2-10	72
0.65 x 0.25 (16.5 x 6.4)	Polyester	Yellow	L	PLL-4-Y2Y-10	72
0.70 x 0.25 (17.8 x 6.4)	Polyester	Silver	L	PEL-1-Y1-10	76
0.70 x 0.25 (17.8 x 6.4)	Polyester	White	L	PEL-1-Y2-10	76
0.70 x 0.33 (17.8 x 8.5)	Polyester	Silver	L	PEL-4-Y1-10	76
0.70 x 0.33 (17.8 x 8.5)	Polyester	White	L	PEL-4-Y2-10	76
0.70 x 0.33 (17.8 x 8.5)	Polyester	Yellow	L	PEL-4-Y2Y-10	76
0.70 x 0.33 (17.8 x 8.5)	Tamp. Evid. Polyester	Silver	L	PEL-4-Y1C-10	76
0.70 x 0.50 (17.8 x 12.7)	Polyester	Matte Clear	L	PEL-10-Y3M-5	76
0.70 x 0.50 (17.8 x 12.7)	Polyester	Silver	L	PEL-10-Y1-5	76
0.70 x 0.50 (17.8 x 12.7)	Polyester	White	L	PEL-10-Y2-5	76
0.70 x 0.50 (17.8 x 12.7)	Polyester	Yellow	L	PEL-10-Y2Y-5	76
0.75 x 0.25 (19.1 x 6.4)	Destructible Paper	White	DM	PDL-85	115
0.75 x 0.25 (19.1 x 6.4)	Destructible Vinyl	White	DM	PDL-273	115
0.75 x 0.25 (19.1 x 6.4)	Destructible Vinyl	White	DM	PDL-38	115
0.75 x 0.25 (19.1 x 6.4)	Destructible Vinyl	White	DM	PDL-38-10	115
0.75 x 0.25 (19.1 x 6.4)	Polyester	Silver	DM	PDL-236	115
0.75 x 0.25 (19.1 x 6.4)	Polyester	Silver	DM	PDL-236-10	115

* DM = Dot-Matrix, IJ = Ink Jet, L = Laser, TT = Thermal Transfer
 ▲TEDLAR is a registered trademark of E.I DuPont Co.

Blank Labels by Size (cont.)

Label Size Width x Length In. (mm)	Material	Color	Print Method*	Part Number	Page No.
0.75 x 0.25 (19.1 x 6.4)	Polyester	Silver	DM	PDL-275	115
0.75 x 0.25 (19.1 x 6.4)	Polyester	Silver	TT	TTC5YS-10	42
0.75 x 0.25 (19.1 x 6.4)	Polyester	White	DM	PDL-274	115
0.75 x 0.25 (19.1 x 6.4)	Polyester	White	DM	PDL-274-10	115
0.75 x 0.25 (19.1 x 6.4)	Polyester	White	DM	PDL-39	115
0.75 x 0.25 (19.1 x 6.4)	Polyester	White	DM	PDL-39-10	115
0.75 x 0.25 (19.1 x 6.4)	Polyester	White	TT	TTC5Y-10	42
0.75 x 0.25 (19.1 x 6.4)	Polyimide	Amber	DM	PDL-235	115
0.75 x 0.25 (19.1 x 6.4)	Polyimide	Amber	DM	PDL-235-10	115
0.75 x 0.25 (19.1 x 6.4)	Polyimide	Amber	DM	PDL-272	115
0.75 x 0.25 (19.1 x 6.4)	Tamp. Evid. Polyester	Silver	TT	TTC5YST-10	42
0.75 x 0.25 (19.1 x 6.4)	TEDLAR *	White	DM	PDL-84	115
0.75 x 0.25 (19.1 x 6.4)	TEDLAR	White	TT	TTC5T-10	42
0.75 x 0.25 (19.1 x 6.4)	Vinyl	White	DM	PDL-190	115
0.75 x 0.25 (19.1 x 6.4)	Vinyl Cloth	White	DM	PDL-270	115
0.75 x 0.25 (19.1 x 6.4)	Vinyl Cloth	White	DM	PDL-37	115
0.75 x 0.25 (19.1 x 6.4)	Vinyl Cloth	White	DM	PDL-37-1	115
0.75 x 0.25 (19.1 x 6.4)	Vinyl Cloth	White	DM	PDL-37-10	115
0.75 x 0.25 (19.1 x 6.4)	Vinyl Cloth	White	DM	PDL-37-50	115
0.75 x 0.25 (19.1 x 6.4) With Tamper Resistant Slits	Polyester	White	DM	PDL-277	115
0.75 x 0.25 (19.1 x 6.4) With Tamper Resistant Slits	Polyester	White	DM	PDL-277-10	115
0.75 x 0.25 (19.1 x 6.4) With Tamper Resistant Slits	Polyimide	Amber	DM	PDL-276	115
0.75 x 0.50 (19.1 x 12.7)	Polyester	White	IJ	JL3Y-10	55
0.75 x 0.50 (19.1 x 12.7)	Vinyl Cloth	White	IJ	JL3C-10	55
0.75 x 1.00 (19.1 x 25.4)	Destructible Paper	White	IJ	JL10P-5	55
0.75 x 1.00 (19.1 x 25.4)	Polyester	White	IJ	JL10Y-5	55
0.75 x 1.00 (19.1 x 25.4)	Vinyl Cloth	White	IJ	JL10C-5	55
0.75 x 1.25 (19.1 x 31.8)	Polyester	White	IJ	JL901Y-5	55
0.75 x 1.25 (19.1 x 31.8)	Polyolefin	White	IJ	JL901P0-5	55
0.75 x 1.25 (19.1 x 31.8)	Vinyl Cloth	White	IJ	JL901C-5	55
0.75 x 1.50 (19.1 x 38.1)	Destructible Paper	White	IJ	JL35P-2.5	55
0.75 x 1.50 (19.1 x 38.1)	Polyester	White	IJ	JL35Y-2.5	55
0.75 x 1.50 (19.1 x 38.1)	Polyolefin	White	IJ	JL35P0-2.5	55
0.75 x 1.50 (19.1 x 38.1)	Vinyl Cloth	White	IJ	JL35C-2.5	55
0.79 x 0.31 (20.0 x 8.0)	Polyester	Yellow	L	PEL-24-Y2Y-10	76
0.79 x 0.32 (20.0 x 8.0)	Vinyl Cloth	White	DM	PDL-192	115
0.79 x 0.32 (20.0 x 8.0)	Vinyl Cloth	Yellow	DM	PDL-191	115
0.80 x 0.20 (20.3 x 5.1)	Polyester	White	DM	PDL-279	115
0.80 x 0.20 (20.3 x 5.1)	Polyester	White	DM	PDL-279-10	115
0.80 x 0.20 (20.3 x 5.1)	Polyester	White	L	PLL-20-Y2-10	72
0.80 x 0.20 (20.3 x 5.1)	Polyester	Yellow	L	PLL-20-Y2Y-10	72
0.80 x 0.20 (20.3 x 5.1)	Polyimide	Amber	DM	PDL-278	115
0.80 x 0.25 (20.3 x 6.4)	Destructible Paper	White	DM	PDL-167	115
0.80 x 0.25 (20.3 x 6.4)	Polyester	White	L	PLL-5-Y2-10	72
0.80 x 0.25 (20.3 x 6.4)	Polyester	Yellow	L	PLL-5-Y2Y-10	72
0.80 x 0.33 (20.3 x 8.5)	Polyester	Silver	L	PEL-5-Y1-10	76
0.80 x 0.33 (20.3 x 8.5)	Polyester	White	L	PEL-5-Y2-10	76
0.80 x 0.33 (20.3 x 8.5)	Polyester	Yellow	L	PEL-5-Y2Y-10	76
0.80 x 0.50 (20.3 x 12.7)	Destructible Paper	White	DM	PDL-174	115

Label Size Width x Length In. (mm)	Material	Color	Print Method*	Part Number	Page No.
0.80 x 0.50 (20.3 x 12.7)	Polyester	White	DM	PDL-172	115
0.80 x 0.50 (20.3 x 12.7)	Polyester	White	DM	PDL-172-10	115
0.80 x 0.50 (20.3 x 12.7)	Polyester	White	L	PLL-6-Y2-10	72
0.80 x 0.50 (20.3 x 12.7)	Polyester	White	L	PLL-6-Y2-5	72
0.80 x 0.50 (20.3 x 12.7)	Polyester	Yellow	L	PLL-6-Y2Y-10	72
0.80 x 0.50 (20.3 x 12.7)	Polyester	Yellow	L	PLL-6-Y2Y-5	72
0.80 x 0.50 (20.3 x 12.7)	Polyimide	Amber	DM	PDL-173	
0.80 x 0.50 (20.3 x 12.7)	Removable Paper	White	DM	PDL-170	115
0.80 x 0.50 (20.3 x 12.7)	Removable Paper	White	DM	PDL-170-10	115
0.80 x 0.50 (20.3 x 12.7)	Vinyl	White	DM	PDL-171	115
0.80 x 0.50 (20.3 x 12.7)	Polyester	White	DM	PDL-172R	115
0.80 x 0.94 (20.3 x 23.8)	TEDLAR	White	DM	PDL-282	116
0.80 x 0.94 (20.3 x 23.8)	Vinyl Cloth	White	DM	PDL-280	116
0.80 x 0.94 (20.3 x 23.8)	Vinyl Cloth	White	DM	PDL-280-10	116
0.80 x 1.44 (20.3 x 36.5)	TEDLAR	White	DM	PDL-10	116
0.80 x 1.44 (20.3 x 36.5)	TEDLAR	White	DM	PDL-10-1	116
0.80 x 1.44 (20.3 x 36.5)	Vinyl	White	DM	PDL-11	116
0.80 x 1.44 (20.3 x 36.5)	Vinyl Cloth	White	DM	PDL-9	116
0.80 x 1.44 (20.3 x 36.5)	Vinyl Cloth	White	DM	PDL-9-10	116
0.80 x 1.44 (20.3 x 36.5)	Vinyl Cloth	White	DM	PDL-9-10T	116
0.80 x 1.50 (20.3 x 38.1)	Polyolefin	White	IJ	JL42P0-1	56
0.81 x 0.50 (20.7 x 12.7)	Polyester	Silver	DM	PDL-175	116
0.83 x 1.88 (21.2 x 47.6)	Destructible Paper	White	IJ	JL17P-2.5	56
0.83 x 1.88 (21.2 x 47.6)	Polyester	White	IJ	JL17Y-2.5	56
0.83 x 1.88 (21.2 x 47.6)	Polyolefin	White	IJ	JL17P0-1	56
0.83 x 1.88 (21.2 x 47.6)	Polyolefin	White	IJ	JL17P0-2.5	56
0.90 x 0.25 (22.9 x 6.4)	Destructible Paper	White	DM	PDL-67	116
0.90 x 0.25 (22.9 x 6.4)	Destructible Paper	White	DM	PDL-92	116
0.90 x 0.25 (22.9 x 6.4)	Polyester	Silver	DM	PDL-68	116
0.90 x 0.25 (22.9 x 6.4)	Polyester	White	DM	PDL-285	116
0.90 x 0.25 (22.9 x 6.4)	Polyester	White	DM	PDL-94	116
0.90 x 0.25 (22.9 x 6.4)	Polyester	White	DM	PDL-94-1	116
0.90 x 0.25 (22.9 x 6.4)	Polyester	White	DM	PDL-94-10	116
0.90 x 0.25 (22.9 x 6.4)	Polyester	White	TT	TTC6Y-10	42
0.90 x 0.25 (22.9 x 6.4)	Polyimide	Amber	DM	PDL-283	116
0.90 x 0.25 (22.9 x 6.4)	Polyimide	Amber	DM	PDL-50	116
0.90 x 0.25 (22.9 x 6.4)	Polyimide	Amber	DM	PDL-50-10	116
0.90 x 0.25 (22.9 x 6.4)	TEDLAR	White	DM	PDL-23	116
0.90 x 0.25 (22.9 x 6.4)	TEDLAR	White	DM	PDL-23-1	116
0.90 x 0.25 (22.9 x 6.4)	TEDLAR	White	DM	PDL-23-10	116
0.90 x 0.25 (22.9 x 6.4)	TEDLAR	White	DM	PDL-284	116
0.90 x 0.25 (22.9 x 6.4)	TEDLAR	White	DM	PDL-49	116
0.90 x 0.25 (22.9 x 6.4)	TEDLAR	White	DM	PDL-49-10	116
0.90 x 0.25 (22.9 x 6.4)	TEDLAR	White	TT	TTC6T-10	42
0.90 x 0.25 (22.9 x 6.4)	Vinyl Cloth	White	DM	PDL-66	116
0.90 x 0.25 (22.9 x 6.4)	Vinyl Cloth	White	DM	PDL-93	116
0.90 x 0.25 (22.9 x 6.4) With Tamper Resistant Slits	Polyester	White	DM	PDL-287	116
0.90 x 0.25 (22.9 x 6.4) With Tamper Resistant Slits	Polyimide	Amber	DM	PDL-286	116
0.98 x 0.59 (25.0 x 15.0)	TEDLAR	White	DM	PDL-4565-1	116

* DM = Dot-Matrix, IJ = Ink Jet, L = Laser, TT = Thermal Transfer
* TEDLAR is a registered trademark of E.I. DuPont Co.

Blank Labels by Size (cont.)

Label Size Width x Length In. (mm)	Material	Color	Print Method*	Part Number	Page No.
1.00 x 0.25 (25.4 x 6.4)	Polyester	Matte Clear	L	PEL-2-Y3M-10	76
1.00 x 0.25 (25.4 x 6.4)	Polyester	Silver	L	PEL-2-Y1-10	76
1.00 x 0.25 (25.4 x 6.4)	Polyester	White	L	PEL-2-Y2-10	76
1.00 x 0.25 (25.4 x 6.4)	Polyester	White	L	PLL-7-Y2-10	72
1.00 x 0.25 (25.4 x 6.4)	Polyester	Yellow	L	PEL-2-Y2Y-10	76
1.00 x 0.25 (25.4 x 6.4)	Polyester	Yellow	L	PLL-7-Y2Y-10	76
1.00 x 0.33 (25.4 x 8.5)	Polyester	Silver	L	PEL-6-Y1-5	76
1.00 x 0.33 (25.4 x 8.5)	Polyester	White	L	PEL-6-Y2-5	76
1.00 x 0.33 (25.4 x 8.5)	Tamp. Evid. Polyester	Silver	L	PEL-6-Y1C-5	76
1.00 x 0.38 (25.4 x 9.5)	Destructible Paper	White	DM	PDL-74	116
1.00 x 0.38 (25.4 x 9.5)	Polyester	Silver	TT	TTC7YS-10	42
1.00 x 0.38 (25.4 x 9.5)	Polyester	White	DM	PDL-31	116
1.00 x 0.38 (25.4 x 9.5)	Polyester	White	DM	PDL-31-10	116
1.00 x 0.38 (25.4 x 9.5)	Polyester	White	L	PLL-8-Y2-10	72
1.00 x 0.38 (25.4 x 9.5)	Polyester	White	L	PLL-8-Y2-5	72
1.00 x 0.38 (25.4 x 9.5)	Polyester	White	TT	TTC7Y-10	42
1.00 x 0.38 (25.4 x 9.5)	Polyester	Yellow	L	PLL-8-Y2Y-10	72
1.00 x 0.38 (25.4 x 9.5)	Polyester	Yellow	L	PLL-8-Y2Y-5	72
1.00 x 0.38 (25.4 x 9.5)	Polyolefin	White	L	PLL-8-PO-10	72
1.00 x 0.38 (25.4 x 9.5)	TEDLAR *	White	DM	PDL-75	116
1.00 x 0.38 (25.4 x 9.5)	Vinyl Cloth	White	DM	PDL-30	116
1.00 x 0.38 (25.4 x 9.5)	Vinyl Cloth	White	DM	PDL-30-1	116
1.00 x 0.38 (25.4 x 9.5)	Vinyl Cloth	White	DM	PDL-30-10	116
1.00 x 0.50 (25.4 x 12.7)	Aluminum	Silver	DM	PDL-97	117
1.00 x 0.50 (25.4 x 12.7)	Destructible Polyethylene	White	TT	TTC8ET-10	42
1.00 x 0.50 (25.4 x 12.7)	Destructible Vinyl	White	DM	PDL-21	117
1.00 x 0.50 (25.4 x 12.7)	Destructible Vinyl	White	DM	PDL-21-1	117
1.00 x 0.50 (25.4 x 12.7)	Destructible Vinyl	White	DM	PDL-21-10	117
1.00 x 0.50 (25.4 x 12.7)	Destructible Vinyl	White	DM	PDL-7294-1	117
1.00 x 0.50 (25.4 x 12.7)	Polyester	Clear	DM	PDL-363	117
1.00 x 0.50 (25.4 x 12.7)	Polyester	Clear	L	PLL-9-Y3C-5	73
1.00 x 0.50 (25.4 x 12.7)	Polyester	Clear	TT	TTC8YC-10	42
1.00 x 0.50 (25.4 x 12.7)	Polyester	Silver	DM	PDL-158	117
1.00 x 0.50 (25.4 x 12.7)	Polyester	Silver	DM	PDL-22	117
1.00 x 0.50 (25.4 x 12.7)	Polyester	Silver	DM	PDL-22-1	117
1.00 x 0.50 (25.4 x 12.7)	Polyester	Silver	DM	PDL-22-10	117
1.00 x 0.50 (25.4 x 12.7)	Polyester	Silver	L	PEL-11-Y1-5	76
1.00 x 0.50 (25.4 x 12.7)	Polyester	Silver	L	PLL-9-Y2S-10	73
1.00 x 0.50 (25.4 x 12.7)	Polyester	Silver	TT	TTC8YS-10	42
1.00 x 0.50 (25.4 x 12.7)	Polyester	White	DM	PDL-157	117
1.00 x 0.50 (25.4 x 12.7)	Polyester	White	DM	PDL-20	117
1.00 x 0.50 (25.4 x 12.7)	Polyester	White	DM	PDL-20-1	117
1.00 x 0.50 (25.4 x 12.7)	Polyester	White	DM	PDL-20-10	117
1.00 x 0.50 (25.4 x 12.7)	Polyester	White	L	PEL-11-Y2-5	76
1.00 x 0.50 (25.4 x 12.7)	Polyester	White	L	PLL-9-Y2-10	73
1.00 x 0.50 (25.4 x 12.7)	Polyester	White	L	PLL-9-Y2-5	73
1.00 x 0.50 (25.4 x 12.7)	Polyester	White	TT	TTC8Y-10	42

Label Size Width x Length In. (mm)	Material	Color	Print Method*	Part Number	Page No.
1.00 x 0.50 (25.4 x 12.7)	Polyester	Yellow	L	PLL-9-Y2Y-10	73
1.00 x 0.50 (25.4 x 12.7)	Polyester	Yellow	L	PLL-9-Y2Y-5	73
1.00 x 0.50 (25.4 x 12.7)	Polyester	Yellow	L	PEL-11-Y2Y-5	76
1.00 x 0.50 (25.4 x 12.7)	Polyimide	Amber	DM	PDL-98	117
1.00 x 0.50 (25.4 x 12.7)	Removable Paper	White	DM	PDL-65	117
1.00 x 0.50 (25.4 x 12.7)	Removable Polyolefin	White	L	PLL-9-POR-10	73
1.00 x 0.50 (25.4 x 12.7)	Tamp. Evid. Polyester	Silver	L	PEL-11-Y1C-5	76
1.00 x 0.50 (25.4 x 12.7)	Tamp. Evid. Polyester	Silver	TT	TTC8YST-10	42
1.00 x 0.50 (25.4 x 12.7)	TEDLAR	White	DM	PDL-99	117
1.00 x 0.50 (25.4 x 12.7)	TEDLAR	White	DM	PDL-99-10	117
1.00 x 0.50 (25.4 x 12.7)	TEDLAR	White	TT	TTC8T-10	42
1.00 x 0.50 (25.4 x 12.7)	TEDLAR	Yellow	DM	PDL-230	117
1.00 x 0.50 (25.4 x 12.7)	Vinyl	White	DM	PDL-188	117
1.00 x 0.50 (25.4 x 12.7)	Vinyl Cloth	White	DM	PDL-19	117
1.00 x 0.50 (25.4 x 12.7)	Vinyl Cloth	White	DM	PDL-19-1	117
1.00 x 0.50 (25.4 x 12.7)	Vinyl Cloth	White	DM	PDL-19-10	117
1.00 x 0.75 (25.4 x 19.1)	Polyester	Clear	L	PLL-10-Y3C-2.5	73
1.00 x 0.75 (25.4 x 19.1)	Polyester	White	L	PLL-10-Y2-2.5	73
1.00 x 0.75 (25.4 x 19.1)	Polyolefin	White	L	PLL-10-PO-5	73
1.00 x 0.75 (25.4 x 19.1)	TEDLAR	White	DM	PDL-290	117
1.00 x 0.75 (25.4 x 19.1)	TEDLAR	White	DM	PDL-290-1	117
1.00 x 0.75 (25.4 x 19.1)	Vinyl Cloth	White	DM	PDL-288	117
1.00 x 0.94 (25.4 x 23.8)	Litho Paper	White	DM	PL115-12	105
1.00 x 0.94 (25.4 x 23.8)	TEDLAR	White	DM	PDL-293	117
1.00 x 0.94 (25.4 x 23.8)	Vinyl Cloth	White	DM	PDL-291	117
1.00 x 1.00 (25.4 x 25.4)	Polyester	Clear	L	PLL-11-Y3C-2.5	73
1.00 x 1.00 (25.4 x 25.4)	Polyester	White	L	PLL-11-Y2-2.5	73
1.00 x 1.33 (25.4 x 33.8)	Polyester	White	L	PLL-12-Y2-1	73
1.00 x 1.33 (25.4 x 33.8)	Polyester	White	L	PLL-12-Y2-2.5	73
1.00 x 1.44 (25.4 x 36.5) With Horizontal Perforation	TEDLAR	White	DM	PDL-296	117
1.00 x 1.44 (25.4 x 36.5) With Horizontal Perforation	Vinyl Cloth	White	DM	PDL-294	117
1.00 x 1.75 (25.4 x 44.5)	Destructible Paper	White	IJ	JL902P-2.5	56
1.00 x 1.75 (25.4 x 44.5)	Polyester	White	IJ	JL902Y-2.5	56
1.13 x 0.53 (28.6 x 13.5)	TEDLAR	White	DM	PDL-4674-3	117
1.13 x 0.53 (28.6 x 13.5)	Vinyl Cloth	White	DM	PDL-4674-1	117
1.18 x 0.37 (30.0 x 9.5)	TEDLAR	White	DM	PDL-4565-2	117
1.25 x 0.25 (31.8 x 6.4)	Polyester	White	TT	TTC9Y-10	42
1.25 x 0.38 (31.8 x 9.5)	Destructible Paper	White	DM	PDL-370	118
1.25 x 0.38 (31.8 x 9.5)	Destructible Paper	White	DM	PDL-70	118
1.25 x 0.38 (31.8 x 9.5)	Polyester	White	DM	PDL-131	118
1.25 x 0.38 (31.8 x 9.5)	Polyester	White	DM	PDL-71	118
1.25 x 0.38 (31.8 x 9.5)	Polyester	White	L	PLL-34-Y2-10	73
1.25 x 0.38 (31.8 x 9.5)	Polyester	White	TT	TTC10Y-10	42
1.25 x 0.38 (31.8 x 9.5)	Polyester	White / Red	DM	PDL-5712-2	118
1.25 x 0.38 (31.8 x 9.5)	Polyester	Yellow	L	PLL-34-Y2Y-10	73
1.25 x 0.38 (31.8 x 9.5)	Removable Polyolefin	White	L	PLL-34-POR-10	73

* DM = Dot-Matrix, IJ = Ink Jet, L = Laser, TT = Thermal Transfer
 * TEDLAR is a registered trademark of E.I DuPont Co.

Blank Labels by Size (cont.)

Label Size Width x Length In. (mm)	Material	Color	Print Method*	Part Number	Page No.
1.25 x 0.38 (31.8 x 9.5)	TEDLAR ^	Gray	DM	PDL-129	118
1.25 x 0.38 (31.8 x 9.5)	TEDLAR	Silver	DM	PDL-26	118
1.25 x 0.38 (31.8 x 9.5)	TEDLAR	White	DM	PDL-128	118
1.25 x 0.38 (31.8 x 9.5)	TEDLAR	White	DM	PDL-128-10	118
1.25 x 0.38 (31.8 x 9.5)	TEDLAR	White	DM	PDL-25	118
1.25 x 0.38 (31.8 x 9.5)	TEDLAR	White	DM	PDL-25-10	118
1.25 x 0.38 (31.8 x 9.5)	TEDLAR	White	TT	TTC10T-10	42
1.25 x 0.38 (31.8 x 9.5)	TEDLAR	Yellow	DM	PDL-127	118
1.25 x 0.38 (31.8 x 9.5)	TEDLAR	Yellow	DM	PDL-24	118
1.25 x 0.38 (31.8 x 9.5)	Vinyl	White	DM	PDL-132	118
1.25 x 0.38 (31.8 x 9.5)	Vinyl	White	DM	PDL-132-10	118
1.25 x 0.38 (31.8 x 9.5)	Vinyl Cloth	White	DM	PDL-130	118
1.25 x 0.38 (31.8 x 9.5)	Vinyl Cloth	White	DM	PDL-69	118
1.38 x 0.19 (34.9 x 4.8)	Polyester	Clear	TT	TTC-MJ-5	42
1.38 x 0.19 (34.9 x 4.8)	Polyolefin	White	IJ	JL412PO-1	56
1.38 x 0.28 (34.9 x 7.1)	Polyester	Clear	DM	PDL-407-1	118
1.38 x 0.28 (34.9 x 7.1)	Polyester	White	DM	PDL-409-1	118
1.40 x 0.25 (35.6 x 6.4)	Polyester	Silver	L	PEL-3-Y1-5	77
1.40 x 0.25 (35.6 x 6.4)	Polyester	White	L	PEL-3-Y2-5	77
1.40 x 0.25 (35.6 x 6.4)	Tamp. Evid. Polyester	Silver	L	PEL-3-Y1C-5	77
1.44 x 0.50 (36.5 x 12.7)	Polyester	White	IJ	JL33Y-5	56
1.44 x 0.50 (36.5 x 12.7)	Polyolefin	White	IJ	JL33PO-2.5	56
1.44 x 0.50 (36.5 x 12.7)	Vinyl Cloth	White	IJ	JL33C-5	56
1.44 x 0.80 (36.5 x 20.3)	Vinyl Cloth	White	IJ	JL900C-2.5	56
1.50 x 0.25 (38.1 x 6.4)	Polyester	Silver	DM	PDL-7542-10	118
1.50 x 0.25 (38.1 x 6.4)	Polyester	White	DM	PDL-358	118
1.50 x 0.25 (38.1 x 6.4)	Polyester	White	L	PLL-14-Y2-10	73
1.50 x 0.25 (38.1 x 6.4)	Polyester	White	L	PLL-14-Y2-5	73
1.50 x 0.25 (38.1 x 6.4)	Polyester	White	TT	TTC11Y-10	42
1.50 x 0.25 (38.1 x 6.4)	Polyester	Yellow	L	PLL-14-Y2Y-5	73
1.50 x 0.25 (38.1 x 6.4)	Polyimide	Amber	DM	PDL-357	118
1.50 x 0.25 (38.1 x 6.4)	Polyolefin	White	L	PLL-14-PO-5	73
1.50 x 0.25 (38.1 x 6.4)	Removable Polyolefin	White	L	PLL-14-POR-5	73
1.50 x 0.25 (38.1 x 6.4) With Vertical Perforation	Polyester	White	DM	PDL-87	118
1.50 x 0.25 (38.1 x 6.4) With Vertical Perforation	Polyester	White	DM	PDL-87-10	118
1.50 x 0.25 (38.1 x 6.4) With Vertical Perforation	Removable Paper	White	DM	PDL-359-10	118
1.50 x 0.25 (38.1 x 6.4) With Vertical Perforation	Removable Paper	White	DM	PDL-40	118
1.50 x 0.25 (38.1 x 6.4) With Vertical Perforation	Removable Paper	White	DM	PDL-40-10	118
1.50 x 0.25 (38.1 x 6.4) With Vertical Perforation	TEDLAR	White	DM	PDL-86	118
1.50 x 0.25 (38.1 x 6.4) With Vertical Perforation	Vinyl	White	DM	PDL-629	118
1.50 x 0.25 (38.1 x 6.4) With Vertical Perforation	Vinyl Cloth	White	DM	PDL-360-10	118
1.50 x 0.25 (38.1 x 6.4) With Vertical Perforation	Vinyl Cloth	White	DM	PDL-41	118
1.50 x 0.25 (38.1 x 6.4) With Vertical Perforation	Vinyl Cloth	White	DM	PDL-41-1	118
1.50 x 0.25 (38.1 x 6.4) With Vertical Perforation	Vinyl Cloth	White	DM	PDL-41-10	118

Label Size Width x Length In. (mm)	Material	Color	Print Method*	Part Number	Page No.
1.50 x 0.33 (38.1 x 8.5)	Polyester	Matte Clear	L	PEL-7-Y3M-5	77
1.50 x 0.33 (38.1 x 8.5)	Polyester	Silver	L	PEL-7-Y1-5	77
1.50 x 0.33 (38.1 x 8.5)	Polyester	White	L	PEL-7-Y2-5	77
1.50 x 0.33 (38.1 x 8.5)	Polyester	Yellow	L	PEL-7-Y2Y-5	77
1.50 x 0.50 (38.1 x 12.7)	Polyester	Silver	L	PEL-12-Y1-2.5	77
1.50 x 0.50 (38.1 x 12.7)	Polyester	White	L	PEL-12-Y2-2.5	77
1.50 x 0.50 (38.1 x 12.7)	Polyester	White	TT	TTC12Y-10	42
1.50 x 0.50 (38.1 x 12.7)	Polyester	Yellow	L	PEL-12-Y2Y-2.5	77
1.50 x 0.75 (38.1 x 19.1)	Destructible Paper	White	DM	PDL-73	119
1.50 x 0.75 (38.1 x 19.1)	Destructible Paper	White	DM	PDL-73-10	119
1.50 x 0.75 (38.1 x 19.1)	Polyester	Silver	DM	PDL-29	119
1.50 x 0.75 (38.1 x 19.1)	Polyester	Silver	DM	PDL-29-1	119
1.50 x 0.75 (38.1 x 19.1)	Polyester	Silver	DM	PDL-29-10	119
1.50 x 0.75 (38.1 x 19.1)	Polyester	Silver	L	PLL-35-Y2S-2.5	73
1.50 x 0.75 (38.1 x 19.1)	Polyester	Silver	TT	TTC13YS-10	42
1.50 x 0.75 (38.1 x 19.1)	Polyester	White	DM	PDL-231	119
1.50 x 0.75 (38.1 x 19.1)	Polyester	White	DM	PDL-231-10	119
1.50 x 0.75 (38.1 x 19.1)	Polyester	White	TT	TTC13Y-10	42
1.50 x 0.75 (38.1 x 19.1)	Polyolefin	White	L	PLL-35-PO-2.5	73
1.50 x 0.75 (38.1 x 19.1)	Removable Polyolefin	White	L	PLL-35-POR-2.5	73
1.50 x 0.75 (38.1 x 19.1)	TEDLAR	White	DM	PDL-27	119
1.50 x 0.75 (38.1 x 19.1)	TEDLAR	White	DM	PDL-27-10	119
1.50 x 0.75 (38.1 x 19.1)	TEDLAR	Yellow	DM	PDL-28	119
1.50 x 0.75 (38.1 x 19.1)	Vinyl Cloth	White	DM	PDL-72	119
1.50 x 0.81 (38.1 x 20.6)	Polyester	White	TT	TTC14Y-2.5	42
1.50 x 0.90 (38.1 x 22.9)	Vinyl Cloth	White	DM	PDL-298	119
1.50 x 0.90 (38.1 x 22.9)	Vinyl Cloth	Yellow	DM	PDL-297	119
1.50 x 1.00 (38.1 x 25.4)	Paper	White	TT	TTC15P-2.5	42
1.50 x 1.00 (38.1 x 25.4)	Polyester	White	TT	TTC15Y-2.5	42
1.50 x 1.13 (38.1 x 28.6)	Polyester	White	TT	TTC16Y-2.5	42
1.63 x 0.38 (41.3 x 9.5)	Polyester	Silver	DM	PDL-7572-10R	119
1.63 x 0.38 (41.3 x 9.5)	Polyester	Silver	DM	PDL-7572-1R	119
1.63 x 1.25 (41.3 x 31.8)	Polyester	White	TT	TTC17Y-2.5	42
1.80 x 0.38 (45.7 x 9.5)	Polyester	White	TT	TTC-EFPL-1	42
1.80 x 0.38 (45.7 x 9.5)	Polyolefin	Blue	DM/L	EFPL-BU-1	100
1.80 x 0.38 (45.7 x 9.5)	Polyolefin	Gray	DM/L	EFPL-IG-1	100
1.80 x 0.38 (45.7 x 9.5)	Polyolefin	Green	DM/L	EFPL-GR-1	100
1.80 x 0.38 (45.7 x 9.5)	Polyolefin	Orange	DM/L	EFPL-EI-1	100
1.80 x 0.38 (45.7 x 9.5)	Polyolefin	Ivory	DM/L	EFPL-OR-1	100
1.80 x 0.38 (45.7 x 9.5)	Polyolefin	Red	DM/L	EFPL-RD-1	100
1.80 x 0.38 (45.7 x 9.5)	Polyolefin	Violet	DM/L	EFPL-VL-1	100
1.80 x 0.38 (45.7 x 9.5)	Polyolefin	White	DM/L	EFPL-1	100
1.80 x 0.38 (45.7 x 9.5)	Polyolefin	Yellow	DM/L	EFPL-YL-1	100
1.80 x 0.38 (45.7 x 9.5)	Polyolefin	White	IJ	JLEFPS-1	56
1.80 x 0.38 (45.7 x 9.5)	Semi-Rigid Vinyl	White	DM/L	EFPT-1	69
1.88 x 0.25 (47.6 x 6.4)	Polyester	White	L	PLL-15-Y2-5	73
1.88 x 0.25 (47.6 x 6.4)	Polyester	White	L	PLL-15-Y2-10	73
1.88 x 0.25 (47.6 x 6.4)	Polyester	Yellow	L	PLL-15-Y2Y-5	73
1.88 x 0.38 (47.6 x 9.5)	Polyester	White	L	PLL-16-Y2-2.5	73
1.88 x 0.38 (47.6 x 9.5)	Polyester	White	L	PLL-16-Y2-5	73

* DM = Dot-Matrix, IJ = Ink Jet, L = Laser, TT = Thermal Transfer
^TEDLAR is a registered trademark of E.I DuPont Co.

Blank Labels by Size (cont.)

Label Size Width x Length In. (mm)	Material	Color	Print Method*	Part Number	Page No.
1.88 x 0.38 (47.6 x 9.5)	Polyester	Yellow	L	PLL-16-Y2Y-2.5	73
1.88 x 0.38 (47.6 x 9.5)	Polyester	Yellow	L	PLL-16-Y2Y-5	73
1.88 x 0.38 (47.6 x 9.5)	Polyolefin	White	L	PLL-16-PO-2.5	73
1.88 x 0.83 (47.6 x 21.2)	Polyester	White	L	PLL-17-Y2-1	73
1.88 x 0.83 (47.6 x 21.2)	Polyester	White	L	PLL-17-Y2-2.5	73
1.88 x 0.83 (47.6 x 21.2)	Polyester	Yellow	L	PLL-17-Y2Y-2.5	73
1.88 x 0.83 (47.6 x 21.2)	Polyolefin	White	L	PLL-17-PO-2.5	73
1.88 x 1.33 (47.6 x 33.8)	Polyester	White	L	PLL-18-Y2-1	74
1.88 x 1.33 (47.6 x 33.8)	Polyester	White	L	PLL-18-Y2-1.5	74
1.88 x 1.33 (47.6 x 33.8)	Polyester	Yellow	L	PLL-18-Y2Y-1	74
1.88 x 1.33 (47.6 x 33.8)	Polyester	Yellow	L	PLL-18-Y2Y-1.5	74
1.88 x 1.33 (47.6 x 33.8)	Polyolefin	White	IJ	JL18PO-1	56
1.95 x 0.40 (49.5 x 10.2)	Semi-Rigid Vinyl	White	DM	PDL-408-TL	119
2.00 x 0.25 (50.8 x 6.4)	Polyester	White	TT	TTC18Y-2.5	42
2.00 x 0.33 (50.8 x 8.5)	Polyester	Silver	L	PEL-8-Y1-2.5	77
2.00 x 0.33 (50.8 x 8.5)	Polyester	White	L	PEL-8-Y2-2.5	77
2.00 x 0.33 (50.8 x 8.5)	Tamp. Evid. Polyester	Silver	L	PEL-8-Y1C-2.5	77
2.00 x 0.38 (50.8 x 9.5)	Destructible Paper	White	DM	PDL-112	119
2.00 x 0.38 (50.8 x 9.5)	Destructible Paper	White	DM	PDL-78	119
2.00 x 0.38 (50.8 x 9.5)	Polyester	Clear	DM	PDL110G5	119
2.00 x 0.38 (50.8 x 9.5)	Polyester	Silver	DM	PDL-7517	119
2.00 x 0.38 (50.8 x 9.5)	Polyester	White	DM	PDL-111	119
2.00 x 0.38 (50.8 x 9.5)	Polyester	White	DM	PDL-111-1	119
2.00 x 0.38 (50.8 x 9.5)	Polyester	White	DM	PDL-77	119
2.00 x 0.38 (50.8 x 9.5)	Polyimide	Amber	DM	PDL-237	119
2.00 x 0.38 (50.8 x 9.5)	TEDLAR *	White	DM	PDL-110	119
2.00 x 0.38 (50.8 x 9.5)	TEDLAR	White	DM	PDL-110-1	119
2.00 x 0.38 (50.8 x 9.5)	TEDLAR	White	DM	PDL-76	119
2.00 x 0.38 (50.8 x 9.5)	Vinyl	White	DM	PDL-113	119
2.00 x 0.38 (50.8 x 9.5)	Vinyl Cloth	White	DM	PDL-114	119
2.00 x 0.38 (50.8 x 9.5)	Vinyl Cloth	White	DM	PDL-32	119
2.00 x 0.38 (50.8 x 9.5)	Vinyl Cloth	White	DM	PDL-32-1	119
2.00 x 0.38 (50.8 x 9.5)	Vinyl Cloth	White	DM	PDL-32-10	119
2.00 x 0.50 (50.8 x 12.7)	Polyester	Silver	L	PEL-13-Y1-2.5	77
2.00 x 0.50 (50.8 x 12.7)	Polyester	White	L	PEL-13-Y2-2.5	77
2.00 x 0.50 (50.8 x 12.7)	Polyester	White	TT	TTC19Y-2.5	42
2.00 x 0.83 (50.8 x 21.2)	Polyester	Silver	L	PEL-14-Y1-1	77
2.00 x 0.83 (50.8 x 21.2)	Polyester	White	L	PEL-14-Y2-1	77
2.00 x 0.90 (50.8 x 22.9)	Destructible Paper	White	DM	PDL-300	119
2.00 x 0.90 (50.8 x 22.9)	Polyester	Silver	DM	PDL-302	119
2.00 x 0.90 (50.8 x 22.9)	Polyester	White	DM	PDL-301	119
2.00 x 0.90 (50.8 x 22.9)	Polyolefin	White	IJ	JL41PO-0.5	56
2.00 x 0.90 (50.8 x 22.9)	Removable Paper	White	DM	PDL-299	119
2.00 x 1.00 (50.8 x 25.4)	Paper	White	TT	TTC20P-2.5	42
2.00 x 1.00 (50.8 x 25.4)	Polyester	Clear	TT	TTC20YC-2.5	42
2.00 x 1.00 (50.8 x 25.4)	Polyester	Silver	L	PEL-15-Y1-1	77
2.00 x 1.00 (50.8 x 25.4)	Polyester	Silver	TT	TTC20YS-2.5	42
2.00 x 1.00 (50.8 x 25.4)	Polyester	White	L	PEL-15-Y2-1	77
2.00 x 1.00 (50.8 x 25.4)	Polyester	White	TT	TTC20Y-2.5	42
2.00 x 1.00 (50.8 x 25.4)	Polyester	Yellow	L	PEL-15-Y2Y-1	77

Label Size Width x Length In. (mm)	Material	Color	Print Method*	Part Number	Page No.
2.00 x 1.00 (50.8 x 25.4)	Tamp. Evid. Polyester	Silver	L	PEL-15-Y1C-1	77
2.00 x 1.00 (50.8 x 25.4)	Tamp. Evid. Polyester	Silver	TT	TTC20YST-2.5	42
2.00 x 1.25 (50.8 x 31.8)	Aluminum	Silver	DM	PDL-148	119
2.00 x 1.25 (50.8 x 31.8)	Destructible Paper	White	DM	PDL-149	119
2.00 x 1.25 (50.8 x 31.8)	Paper	White	TT	TTC21P-2.5	42
2.00 x 1.25 (50.8 x 31.8)	Polyester	Silver	DM	PDL-145	119
2.00 x 1.25 (50.8 x 31.8)	Polyester	White	DM	PDL-150	119
2.00 x 1.25 (50.8 x 31.8)	Vinyl	White	DM	PDL-146	119
2.00 x 1.25 (50.8 x 31.8)	Vinyl Cloth	White	DM	PDL-147	119
2.00 x 1.44 (50.8 x 36.5)	Destructible Paper	White	DM	PDL-304	120
2.00 x 1.44 (50.8 x 36.5)	Polyester	Silver	DM	PDL-306	120
2.00 x 1.44 (50.8 x 36.5)	Polyester	White	DM	PDL-305	120
2.00 x 1.44 (50.8 x 36.5)	Polyester	White	DM	PDL-305-10	120
2.00 x 1.44 (50.8 x 36.5)	Removable Paper	White	DM	PDL-303	120
2.50 x 0.94 (63.5 x 23.8)	Litho Paper	White	DM	PL2515-1	103
2.50 x 0.94 (63.5 x 23.8)	Litho Paper	White	DM	PL2515-2	103
2.50 x 0.94 (63.5 x 23.8)	Litho Paper	White	DM	PL2515-3	103
2.50 x 0.94 (63.5 x 23.8)	Litho Paper	White	DM	PL2515-4	103
2.50 x 0.94 (63.5 x 23.8)	Litho Paper	White	DM	PL2515-5	103
2.50 x 1.00 (63.5 x 25.4)	Polyester	Silver	L	PLL-36-Y2S-1	74
2.50 x 1.00 (63.5 x 25.4)	Polyester	White	L	PLL-36-Y2-1	74
2.50 x 1.00 (63.5 x 25.4)	Polyolefin	White	L	PLL-36-PO-1	74
2.50 x 1.00 (63.5 x 25.4)	Removable Polyolefin	White	L	PLL-36-POR-1	74
2.50 x 1.33 (63.5 x 33.9)	Polyester	Silver	L	PEL-16-Y1-0.5	77
2.50 x 1.33 (63.5 x 33.9)	Polyester	White	L	PEL-16-Y2-0.5	77
2.50 x 1.33 (63.5 x 33.9)	Tamp. Evid. Polyester	Silver	L	PEL-16-Y1C-0.5	77
2.50 x 4.25 (63.5 x 108.0)	TEDLAR	White	DM	PDL-7557-1	120
2.75 x 0.44 (69.9 x 11.1)	Litho Paper	White	DM	PL2757-1	103
2.75 x 0.44 (69.9 x 11.1)	Litho Paper	White	DM	PL2757-4	103
2.75 x 0.94 (69.9 x 23.8)	Litho Paper	White	DM	PL27515-1	103
2.75 x 0.94 (69.9 x 23.8)	Litho Paper	White	DM	PL27515-3	103
2.75 x 0.94 (69.9 x 23.8)	Litho Paper	White	DM	PL27515-4	103
2.75 x 1.25 (69.9 x 31.8)	Paper	White	TT	TTC22P-2.5	43
2.75 x 1.25 (69.9 x 31.8)	Polyester	Silver	TT	TTC22YS-2.5	43
2.75 x 1.25 (69.9 x 31.8)	Polyester	White	TT	TTC22Y-2.5	43
2.75 x 1.44 (69.9 x 36.5)	Litho Paper	White	DM	PL27517-1	103
2.75 x 1.94 (69.9 x 49.2)	Litho Paper	White	DM	PL275115-1	103
2.75 x 2.75 (69.9 x 69.9)	Destructible Paper	White	IJ	JL903P-0.5	56
2.80 x 1.00 (71.1 x 25.4)	Destructible Paper	White	DM	PDL-163	120
2.80 x 1.00 (71.1 x 25.4)	Vinyl Cloth	White	DM	PDL-164	120
2.80 x 1.50 (71.1 x 38.1)	Destructible Paper	White	DM	PDL-165	120
2.80 x 1.50 (71.1 x 38.1)	Vinyl Cloth	White	DM	PDL-166	120
2.83 x 1.00 (72.0 x 25.4)	Litho Paper	White	L	LL2561-100	75
2.83 x 1.00 (72.0 x 25.4)	Litho Paper	White	L	LL2561-100G	75
2.83 x 1.00 (72.0 x 25.4)	Litho Paper	White	L	LL2561-250	75
2.83 x 1.00 (72.0 x 25.4)	Litho Paper	White	L	LL2561-500	75

* DM = Dot-Matrix, IJ = Ink Jet, L = Laser, TT = Thermal Transfer
 * TEDLAR is a registered trademark of E.I. DuPont Co.

Blank Labels by Size (cont.)

Label Size Width x Length In. (mm)	Material	Color	Print Method*	Part Number	Page No.
2.83 x 1.00 (72.0 x 25.4)	Polyester	White	L	PLL-26-Y2-1	74
2.83 x 1.38 (72.0 x 34.9)	Litho Paper	White	L	LL256138-100	75
2.83 x 1.38 (72.0 x 34.9)	Polyester	White	L	PLL-27-Y2-1	74
2.83 x 1.50 (72.0 x 38.1)	Litho Paper	White	L	LL25615-100G	75
2.83 x 1.50 (72.0 x 38.1)	Polyester	White	L	PLL-28-Y2-1	74
2.90 x 0.30 (73.7 x 7.6)	Polyester	White	TT	TTC-EFPL10-1	43
2.90 x 0.30 (73.7 x 7.6)	Polyolefin	Blue	DM/L	EFPL10-BU-1	100
2.90 x 0.30 (73.7 x 7.6)	Polyolefin	Gray	DM/L	EFPL10-IG-1	100
2.90 x 0.30 (73.7 x 7.6)	Polyolefin	Green	DM/L	EFPL10-GR-1	100
2.90 x 0.30 (73.7 x 7.6)	Polyolefin	Ivory	DM/L	EFPL10-EI-1	100
2.90 x 0.30 (73.7 x 7.6)	Polyolefin	Orange	DM/L	EFPL10-OR-1	100
2.90 x 0.30 (73.7 x 7.6)	Polyolefin	Red	DM/L	EFPL10-RD-1	100
2.90 x 0.30 (73.7 x 7.6)	Polyolefin	Violet	DM/L	EFPL10-VL-1	100
2.90 x 0.30 (73.7 x 7.6)	Polyolefin	White	DM/L	EFPL10-1	100
2.90 x 0.30 (73.7 x 7.6)	Polyolefin	Yellow	DM/L	EFPL10-YL-1	100
2.90 x 0.30 (73.7 x 7.6)	Semi-Rigid Vinyl	White	DM/L	EFPT10-1	69
2.90 x 0.94 (73.7 x 23.8)	Litho Paper	White	DM	PL2915-4	103
3.00 x 0.25 (76.2 x 6.4)	Polyester	White	TT	TTC23Y-2.5	43
3.00 x 0.33 (76.2 x 8.5)	Semi-Rigid Vinyl	White	DM	PDL-410-TL	120
3.00 x 0.38 (76.2 x 9.5)	Destructible Paper	White	DM	PDL-81	120
3.00 x 0.38 (76.2 x 9.5)	Polyester	White	DM	PDL-80	120
3.00 x 0.38 (76.2 x 9.5)	Polyester	White	L	PLL-19-Y2-1	74
3.00 x 0.38 (76.2 x 9.5)	Polyester	White	L	PLL-19-Y2-2.5	74
3.00 x 0.38 (76.2 x 9.5)	Polyester	Yellow	L	PLL-19-Y2Y-1	74
3.00 x 0.38 (76.2 x 9.5)	Polyester	Yellow	L	PLL-19-Y2Y-2.5	74
3.00 x 0.38 (76.2 x 9.5)	Polyimide	Amber	DM	PDL-232	120
3.00 x 0.38 (76.2 x 9.5)	Removable Polyolefin	White	L	PLL-19-POR-2.5	74
3.00 x 0.38 (76.2 x 9.5)	TEDLAR *	White	DM	PDL-79	120
3.00 x 0.38 (76.2 x 9.5)	Vinyl Cloth	White	DM	PDL-33	120
3.00 x 0.90 (76.2 x 22.9)	Destructible Paper	White	DM	PDL-310	120
3.00 x 0.90 (76.2 x 22.9)	Destructible Paper	White	TT	TTC46P-5	43
3.00 x 0.90 (76.2 x 22.9)	Polyester	Silver	DM	PDL-312	120
3.00 x 0.90 (76.2 x 22.9)	Polyester	White	DM	PDL-311	120
3.00 x 0.90 (76.2 x 22.9)	Removable Paper	White	DM	PDL-309	120
3.00 x 0.90 (76.2 x 22.9)	Vinyl Cloth	White	DM	PDL-308	120
3.00 x 0.90 (76.2 x 22.9)	Vinyl Cloth	Yellow	DM	PDL-307	120
3.00 x 0.94 (76.2 x 23.8)	Litho Paper	White	DM	PL315-1	103
3.00 x 0.94 (76.2 x 23.8)	Litho Paper	White	DM	PL315-4	103
3.00 x 1.00 (76.2 x 25.4)	Paper	White	TT	TTC24P-2.5	43
3.00 x 1.00 (76.2 x 25.4)	Polyester	Clear	TT	TTC24YC-2.5	43
3.00 x 1.00 (76.2 x 25.4)	Polyester	Silver	TT	TTC24YS-2.5	43
3.00 x 1.00 (76.2 x 25.4)	Polyester	White	TT	TTC24Y-2.5	43
3.00 x 1.00 (76.2 x 25.4)	Tamp. Evid. Polyester	Silver	TT	TTC24YST-2.5	43
3.00 x 1.44 (76.2 x 36.5)	Destructible Paper	White	DM	PDL-314	120
3.00 x 1.44 (76.2 x 36.5)	Polyester	Silver	DM	PDL-316	120
3.00 x 1.44 (76.2 x 36.5)	Polyester	White	DM	PDL-315	120
3.00 x 1.44 (76.2 x 36.5)	Removable Paper	White	DM	PDL-313	120

Label Size Width x Length In. (mm)	Material	Color	Print Method*	Part Number	Page No.
3.00 x 1.90 (76.2 x 48.3)	Destructible Paper	White	DM	PDL-318	120
3.00 x 1.90 (76.2 x 48.3)	Polyester	Silver	DM	PDL-320	120
3.00 x 1.90 (76.2 x 48.3)	Polyester	White	DM	PDL-319	120
3.00 x 1.90 (76.2 x 48.3)	Removable Paper	White	DM	PDL-317	120
3.00 x 2.00 (76.2 x 50.8)	Aluminum	Silver	DM	PDL-143	120
3.00 x 2.00 (76.2 x 50.8)	Destructible Paper	White	DM	PDL-141	120
3.00 x 2.00 (76.2 x 50.8)	Paper	White	TT	TTC25P-1	43
3.00 x 2.00 (76.2 x 50.8)	Polyester	Clear	TT	TTC25YC-1	43
3.00 x 2.00 (76.2 x 50.8)	Polyester	Silver	DM	PDL-139	120
3.00 x 2.00 (76.2 x 50.8)	Polyester	Silver	TT	TTC25YS-1	43
3.00 x 2.00 (76.2 x 50.8)	Polyester	White	DM	PDL-144	120
3.00 x 2.00 (76.2 x 50.8)	Polyester	White	TT	TTC25Y-1	43
3.00 x 2.00 (76.2 x 50.8)	Tamp. Evid. Polyester	Silver	TT	TTC25YST-1	43
3.00 x 2.00 (76.2 x 50.8)	Vinyl	White	DM	PDL-140	120
3.00 x 2.00 (76.2 x 50.8)	Vinyl Cloth	White	DM	PDL-142	120
3.00 x 5.00 (76.2 x 127.0)	Paper	White	TT	TTC26P-1	43
3.20 x 0.90 (81.3 x 22.9)	Litho Paper	White	DM	PL3278-4	104
3.20 x 0.90 (81.3 x 22.9)	Litho Paper	White	DM	PL329-4	104
3.20 x 0.94 (81.3 x 23.8)	Litho Paper	White	DM	PL3215-4	103
3.25 x 0.31 (82.6 x 7.92)	Polyester	White	TT	TTC27Y-10	43
3.25 x 0.50 (82.6 x 12.7)	Polyester	White	TT	TTC28Y-10	43
3.25 x 0.63 (82.6 x 15.9)	Polyester	White	TT	TTC29Y-5	43
3.25 x 0.81 (82.6 x 20.6)	Polyester	White	TT	TTC30Y-2.5	43
3.25 x 1.25 (82.6 x 31.8)	Aluminum	Silver	DM	PDL-154	120
3.25 x 1.25 (82.6 x 31.8)	Destructible Paper	White	DM	PDL-155	120
3.25 x 1.25 (82.6 x 31.8)	Polyester	Silver	DM	PDL-151	120
3.25 x 1.25 (82.6 x 31.8)	Polyester	White	DM	PDL-156	120
3.25 x 1.25 (82.6 x 31.8)	Vinyl	White	DM	PDL-152	120
3.25 x 1.25 (82.6 x 31.8)	Vinyl Cloth	White	DM	PDL-153	120
3.30 x 0.94 (83.8 x 23.8)	Litho Paper	White	DM	PL3315-4	103
3.50 x 0.44 (88.9 x 11.1)	Litho Paper	White	DM	PL357-1	103
3.50 x 0.44 (88.9 x 11.1)	Litho Paper	White	DM	PL357-2	103
3.50 x 0.44 (88.9 x 11.1)	Litho Paper	White	DM	PL357-3	103
3.50 x 0.64 (88.9 x 16.1)	Litho Paper	Blue	DM	PL3510-1FB	104
3.50 x 0.64 (88.9 x 16.1)	Litho Paper	Brown	DM	PL3510-1FBR	104
3.50 x 0.64 (88.9 x 16.1)	Litho Paper	Green	DM	PL3510-1FG	104
3.50 x 0.64 (88.9 x 16.1)	Litho Paper	Orange	DM	PL3510-1FO	104
3.50 x 0.64 (88.9 x 16.1)	Litho Paper	Pink	DM	PL3510-1FP	104
3.50 x 0.64 (88.9 x 16.1)	Litho Paper	Purple	DM	PL3510-1FPU	104
3.50 x 0.64 (88.9 x 16.1)	Litho Paper	Red	DM	PL3510-1FR	104
3.50 x 0.64 (88.9 x 16.1)	Litho Paper	White	DM	PL3510-1F	104
3.50 x 0.64 (88.9 x 16.1)	Litho Paper	Yellow	DM	PL3510-1FY	104
3.50 x 0.94 (88.9 x 23.8)	Litho Paper	White	DM	PL3515-1	103
3.50 x 0.94 (88.9 x 23.8)	Litho Paper	White	DM	PL3515-2	103
3.50 x 0.94 (88.9 x 23.8)	Litho Paper	White	DM	PL3515-3	103
3.50 x 0.94 (88.9 x 23.8)	Litho Paper	White	DM	PL3515-4	103
3.50 x 0.94 (88.9 x 23.8)	Litho Paper	Blue	DM	PL3515-1TB	104
3.50 x 0.94 (88.9 x 23.8)	Litho Paper	Green	DM	PL3515-1TG	104
3.50 x 0.94 (88.9 x 23.8)	Litho Paper	Pink	DM	PL3515-1TP	104
3.50 x 0.94 (88.9 x 23.8)	Litho Paper	Tan	DM	PL3515-1TT	104
3.50 x 0.94 (88.9 x 23.8)	Litho Paper	Yellow	DM	PL3515-1TY	104

* DM = Dot-Matrix, IJ = Ink Jet, L = Laser, TT = Thermal Transfer
 * TEDLAR is a registered trademark of E.I. DuPont Co.

Blank Labels by Size (cont.)

Label Size Width x Length In. (mm)	Material	Color	Print Method*	Part Number	Page No.
3.50 x 0.94 (88.9 x 23.8)	Litho Paper	White	DM	PL3515-1TRL	105
3.50 x 0.94 (88.9 x 23.8)	Removable Litho Paper	White	DM	PL3515-1R	105
3.50 x 0.94 (88.9 x 23.8)	Removable Litho Paper	White	DM	PL3515-3R	105
3.50 x 1.00 (88.9 x 25.4)	Paper	White	TT	TTC31P-1	43
3.50 x 1.00 (88.9 x 25.4)	Polyester	White	TT	TTC31Y-1	43
3.50 x 1.44 (88.9 x 36.5)	Litho Paper	White	DM	PL3517-TRL	105
3.50 x 1.44 (88.9 x 36.5)	Litho Paper	White	DM	PL3517-1	103
3.50 x 1.44 (88.9 x 36.5)	Litho Paper	White	DM	PL3517-3	103
3.50 x 1.94 (88.9 x 49.2)	Litho Paper	White	DM	PL35115-1	103
3.50 x 1.94 (88.9 x 49.2)	Litho Paper	White	DM	PL35115-3	103
3.50 x 8.00 (88.9 x 203.2)	Paper	White	TT	TTC32P-1	43
3.50 x 8.00 (88.9 x 203.2)	Polyester	White	TT	TTC32Y-1	43
3.63 x 1.00 (92.1 x 25.4)	Destructible Paper	White	DM	PDL-159	121
3.63 x 1.00 (92.1 x 25.4)	Vinyl Cloth	White	DM	PDL-160	121
3.63 x 1.50 (92.1 x 38.1)	Destructible Paper	White	DM	PDL-161	121
3.63 x 1.50 (92.1 x 38.1)	Vinyl Cloth	White	DM	PDL-162	121
3.63 x 4.22 (92.1 x 107.1)	Paper	White	TT	TTC34P-5	43
3.63 x 5.79 (92.1 x 147.1)	Paper	White	TT	TTC33P-5	43
3.88 x 1.44 (98.4 x 36.5)	Litho Paper	White	DM	PL3817-1TRL	105
3.88 x 1.75 (98.4 x 44.5)	Litho Paper	White	DM	PL38175-1TRL	105
3.90 x 0.90 (99.1 x 22.9)	Vinyl Cloth	White	DM	PDL-322	121
3.90 x 0.90 (99.1 x 22.9)	Vinyl Cloth	Yellow	DM	PDL-321	121
3.90 x 1.44 (99.1 x 36.5)	Destructible Paper	White	DM	PDL-326	121
3.90 x 1.44 (99.1 x 36.5)	Polyester	Silver	DM	PDL-328	121
3.90 x 1.44 (99.1 x 36.5)	Polyester	White	DM	PDL-327	121
3.90 x 1.44 (99.1 x 36.5)	Removable Paper	White	DM	PDL-325	121
3.90 x 1.44 (99.1 x 36.5)	Vinyl Cloth	White	DM	PDL-324	121
3.90 x 1.44 (99.1 x 36.5)	Vinyl Cloth	Yellow	DM	PDL-323	121
3.90 x 2.90 (99.1 x 73.7)	Vinyl Cloth	White	DM	PDL-330	121
3.90 x 2.90 (99.1 x 73.7)	Vinyl Cloth	Yellow	DM	PDL-329	121
4.00 x 0.44 (101.6 x 11.1)	Litho Paper	White	DM	PL47-1	103
4.00 x 0.94 (101.6 x 23.8)	Litho Paper	Blue	DM	PL417-1TB	104
4.00 x 0.94 (101.6 x 23.8)	Litho Paper	Green	DM	PL417-1TG	104
4.00 x 0.94 (101.6 x 23.8)	Litho Paper	Pink	DM	PL417-1TP	104
4.00 x 0.94 (101.6 x 23.8)	Litho Paper	Tan	DM	PL417-1TT	104
4.00 x 0.94 (101.6 x 23.8)	Litho Paper	White	DM	PL415-1	103
4.00 x 0.94 (101.6 x 23.8)	Litho Paper	White	DM	PL415-2	103
4.00 x 0.94 (101.6 x 23.8)	Litho Paper	White	DM	PL415-3	103
4.00 x 0.94 (101.6 x 23.8)	Litho Paper	Yellow	DM	PL417-1TY	104
4.00 x 0.94 (101.6 x 23.8)	Removable Litho Paper	White	DM	PL417-1R	105
4.00 x 1.00 (101.6 x 25.4)	Paper	White	TT	TTC35P-2.5	43
4.00 x 1.00 (101.6 x 25.4)	Polyester	White	TT	TTC35Y-2.5	43
4.00 x 1.44 (101.6 x 36.5)	Litho Paper	White	DM	PL417-1	103
4.00 x 1.44 (101.6 x 36.5)	Litho Paper	White	DM	PL417-1TRL	104
4.00 x 1.44 (101.6 x 36.5)	Litho Paper	White	DM	PL417-2	103
4.00 x 1.44 (101.6 x 36.5)	Litho Paper	White	DM	PL417-3	103
4.00 x 1.75 (101.6 x 44.5)	Litho Paper	White	DM	PL4175-1TRL	105
4.00 x 1.94 (101.6 x 49.2)	Litho Paper	White	DM	PL4115-1	103
4.00 x 1.94 (101.6 x 49.2)	Litho Paper	White	DM	PL4115-3	103

Label Size Width x Length In. (mm)	Material	Color	Print Method*	Part Number	Page No.
4.00 x 2.00 (101.6 x 50.8)	Paper	White	TT	TTC36P-1	43
4.00 x 2.00 (101.6 x 50.8)	Polyester	Silver	TT	TTC36YS-1	43
4.00 x 2.00 (101.6 x 50.8)	Polyester	White	TT	TTC36Y-1	43
4.00 x 2.44 (101.6 x 61.9)	Litho Paper	White	DM	PL427-1	103
4.00 x 2.94 (101.6 x 74.6)	Litho Paper	White	DM	PL4215-1	103
4.00 x 2.94 (101.6 x 74.6)	Litho Paper	White	DM	PL4215-3	103
4.00 x 3.00 (101.6 x 76.2)	Paper	White	TT	TTC37P-1	43
4.00 x 3.00 (101.6 x 76.2)	Polyester	White	TT	TTC37Y-1	43
4.00 x 4.00 (101.6 x 101.6)	Paper	White	TT	TTC38P-1	43
4.00 x 4.00 (101.6 x 101.6)	Polyester	White	TT	TTC38Y-1	43
4.00 x 5.00 (101.6 x 127.0)	Paper	White	TT	TTC39P-1	43
4.00 x 5.00 (101.6 x 127.0)	Polyester	White	TT	TTC39Y-1	43
4.00 x 6.00 (101.6 x 152.4)	Paper	White	TT	TTC40P-1	43
4.00 x 6.50 (101.6 x 165.1)	Paper	White	TT	TTC41P-1	43
4.00 x 6.50 (101.6 x 165.1)	Polyester	White	TT	TTC41Y-1	43
4.00 x 12.88 (101.6 x 327.0)	Paper	White	TT	TTC42P-5	43
4.00 x 12.88 (101.6 x 327.0)	Polyester	White	TT	TTC42Y-5	43
4.25 x 2.00 (108.0 x 50.8)	Litho Paper	White	L	LL4252-100G	75
4.25 x 2.00 (108.0 x 50.8)	Litho Paper	White	L	LL425275-250	75
4.25 x 2.00 (108.0 x 50.8)	Polyester	White	L	PLL-29-Y2-1	74
4.25 x 2.94 (108.0 x 74.6)	Litho Paper	White	DM	PL425215-1	103
4.25 x 13.00 (108.0 x 330.2)	Litho Paper	White	L	LL42513-100G	75
5.00 x 0.44 (127.0 x 11.1)	Litho Paper	White	DM	PL57-1	103
5.00 x 0.94 (127.0 x 23.8)	Litho Paper	White	DM	PL515-1	103
5.00 x 0.94 (127.0 x 23.8)	Litho Paper	White	DM	PL515-2	103
5.00 x 1.44 (127.0 x 36.5)	Litho Paper	White	DM	PL517-1	103
5.00 x 1.94 (127.0 x 49.2)	Litho Paper	White	DM	PL5115-1	103
5.00 x 2.94 (127.0 x 74.6)	Litho Paper	White	DM	PL5215-1	103
5.00 x 2.94 (127.0 x 74.6)	Litho Paper	White	DM	PL5215-2	103
5.00 x 3.94 (127.0 x 100.0)	Litho Paper	White	DM	PL5315-1	103
5.00 x 3.94 (127.0 x 100.0)	Litho Paper	White	DM	PL5315-2	103
5.00 x 4.00 (127.0 x 101.6)	Paper	White	TT	TTC43P-1	44
5.00 x 4.00 (127.0 x 101.6)	Polyester	White	TT	TTC43Y-1	44
5.75 x 2.94 (146.1 x 74.6)	Litho Paper	White	DM	PL575215-1	103
6.00 x 0.90 (152.4 x 22.9)	Vinyl Cloth	White	DM	PDL-332	121
6.00 x 0.90 (152.4 x 22.9)	Vinyl Cloth	Yellow	DM	PDL-331	121
6.00 x 1.44 (152.4 x 36.6)	Vinyl Cloth	White	DM	PDL-334	121
6.00 x 1.44 (152.4 x 36.6)	Vinyl Cloth	Yellow	DM	PDL-333	121
6.00 x 1.90 (152.4 x 48.3)	Vinyl Cloth	White	DM	PDL-336	121
6.00 x 1.90 (152.4 x 48.3)	Vinyl Cloth	Yellow	DM	PDL-335	121
6.00 x 2.90 (152.4 x 73.7)	Vinyl Cloth	White	DM	PDL-338	121
6.00 x 2.90 (152.4 x 73.7)	Vinyl Cloth	Yellow	DM	PDL-337	121
6.00 x 3.94 (152.4 x 100.0)	Destructible Paper	White	DM	PDL-340	121
6.00 x 3.94 (152.4 x 100.0)	Removable Paper	White	DM	PDL-339	121
6.00 x 3.98 (152.4 x 100.0)	Litho Paper	White	DM	PL6315-1	105
6.00 x 3.98 (152.4 x 100.0)	Litho Paper	White	DM	PL6315-2	105
6.00 x 3.98 (152.4 x 100.0)	Litho Paper	White	DM	PL65315-2	105
6.00 x 4.00 (152.4 x 101.6)	Paper	White	TT	TTC44P-1	44
6.00 x 4.00 (152.4 x 101.6)	Polyester	White	TT	TTC44Y-1	44
7.50 x 0.50 (190.5 x 12.7)	Polyester	Clear	DM	PDL-404-1	121
7.50 x 0.50 (190.5 x 12.7)	Polyester	Clear	DM	PDL-404-2.5	121
7.50 x 0.50 (190.5 x 12.7)	Polyester	White	DM	PDL-403-1	121
7.50 x 0.50 (190.5 x 12.7)	Polyester	Blue	DM	PDL-403-1B	121

* DM = Dot-Matrix, IJ = Ink Jet, L = Laser, TT = Thermal Transfer

Blank Labels by Size (cont.)

Label Size Width x Length In. (mm)	Material	Color	Print Method*	Part Number	Page No.
7.50 x 0.50 (190.5 x 12.7)	Polyester	Brown	DM	PDL-403-1BR	121
7.50 x 0.50 (190.5 x 12.7)	Polyester	Green	DM	PDL-403-1G	121
7.50 x 0.50 (190.5 x 12.7)	Polyester	Gray	DM	PDL-403-1GR	121
7.50 x 0.50 (190.5 x 12.7)	Polyester	Orange	DM	PDL-403-1OR	121
7.50 x 0.50 (190.5 x 12.7)	Polyester	Purple	DM	PDL-403-1PR	121
7.50 x 0.50 (190.5 x 12.7)	Polyester	Red	DM	PDL-403-1R	121
7.50 x 0.50 (190.5 x 12.7)	Polyester	Yellow	DM	PDL-403-1Y	121
7.50 x 0.50 (190.5 x 12.7)	Polyester	White	DM	PDL-403-2.5	121
7.75 x 0.44 (196.9 x 11.1)	Litho Paper	White	DM	PL7757-1	103
7.75 x 0.94 (196.9 x 23.8)	Litho Paper	White	DM	PL77515-1	103
7.88 x 0.50 (200.0 x 12.7)	Polyester	Clear	L	PLL-22-Y3-1	74
7.88 x 0.50 (200.0 x 12.7)	Polyester	White	L	PLL-22-Y2-1	74
7.88 x 0.50 (200.0 x 12.7)	Polyolefin	Blue	L	PLL-22-PO-1B	74
7.88 x 0.50 (200.0 x 12.7)	Polyolefin	Brown	L	PLL-22-PO-1BR	74
7.88 x 0.50 (200.0 x 12.7)	Polyolefin	Gray	L	PLL-22-PO-1GR	74
7.88 x 0.50 (200.0 x 12.7)	Polyolefin	Green	L	PLL-22-PO-1G	74
7.88 x 0.50 (200.0 x 12.7)	Polyolefin	Orange	L	PLL-22-PO-1OR	74
7.88 x 0.50 (200.0 x 12.7)	Polyolefin	Purple	L	PLL-22-PO-1PR	74
7.88 x 0.50 (200.0 x 12.7)	Polyolefin	Red	L	PLL-22-PO-1R	74
7.88 x 0.50 (200.0 x 12.7)	Polyolefin	White	IJ	JL22PO-1	56
7.88 x 0.50 (200.0 x 12.7)	Polyolefin	White	L	PLL-22-PO-1	74
7.88 x 0.50 (200.0 x 12.7)	Polyolefin	Yellow	L	PLL-22-PO-1Y	74
8.00 x 1.44 (203.2 x 36.5)	Vinyl Cloth	White	DM	PDL-342	121
8.00 x 1.44 (203.2 x 36.5)	Vinyl Cloth	Yellow	DM	PDL-341	121
8.27 x 11.69 (210.0 x 297.0)	Polyester	Clear	L	PEL-A4-Y3-25	77
8.27 x 11.69 (210.0 x 297.0)	Polyester	Matte Clear	L	PEL-A4-Y3M-25	77
8.27 x 11.69 (210.0 x 297.0)	Polyester	Silver	L	PEL-A4-Y1-25	77
8.27 x 11.69 (210.0 x 297.0)	Polyester	White	L	PEL-A4-Y2-25	77
8.27 x 11.69 (210.0 x 297.0)	Polyester	Yellow	L	PEL-A4-Y2Y-25	77
8.27 x 11.69 (210.0 x 297.0)	Tamp. Evid. Polyester	Silver	L	PEL-A4-Y1C-25	77
8.50 x 11.00 (215.9 x 279.4)	Destructible Paper	White	IJ	JL25P-SH	56
8.50 x 11.00 (215.9 x 279.4)	Litho Paper	White	L	LL8511-100	75
8.50 x 11.00 (215.9 x 279.4)	Polyester	Clear	L	PLL-25-Y3C-SH	74
8.50 x 11.00 (215.9 x 279.4)	Polyester	Silver	L	PLL-25-Y2S-SH	74
8.50 x 11.00 (215.9 x 279.4)	Polyester	White	IJ	JL25Y-SH	56
8.50 x 11.00 (215.9 x 279.4)	Polyester	White	L	PLL-25-Y2-SH	74
8.50 x 11.00 (215.9 x 279.4)	Polyester	Yellow	L	PLL-25-Y2Y-SH	74
8.50 x 11.00 (215.9 x 279.4)	Polyolefin	White	L	PLL-25-PO-SH	74
8.50 x 11.00 (215.9 x 279.4)	Removable Polyolefin	White	L	PLL-25-POR-SH	74
12.00 x 1.90 (304.8 x 48.3)	Vinyl Cloth	White	DM	PDL-344	121
12.00 x 1.90 (304.8 x 48.3)	Vinyl Cloth	Yellow	DM	PDL-343	121
12.00 x 2.90 (304.8 x 73.7)	Vinyl Cloth	White	DM	PDL-346	121
12.00 x 2.90 (304.8 x 73.7)	Vinyl Cloth	Yellow	DM	PDL-345	121
13.00 x 3.94 (304.8 x 100.0)	Litho Paper	White	DM	PL130315-2	105

* DM = Dot-Matrix, IJ = Ink Jet, L = Laser, TT = Thermal Transfer

Self-Laminating Labels by Size

Label Size Width x Length In. (mm)	Print-On Area Size Width x Length In. (mm)	Material	Print-On Area Color	Print Method*	Part Number	Page No.
0.30 x 0.75 (7.6 x 19.1)	0.30 x 0.38 (7.6 x 9.5)	Self-Laminating Polyolefin	White	DM	PDL-239VF	106
0.30 x 0.75 (7.6 x 19.1)	0.30 x 0.38 (7.6 x 9.5)	Self-Laminating TEDLAR ^	White	DM	PDL-238	106
0.30 x 0.75 (7.6 x 19.1)	0.30 x 0.38 (7.6 x 9.5)	Self-Laminating Vinyl	White	DM	PDL-239	106
0.30 x 0.94 (7.6 x 23.8)	0.30 x 0.38 (7.6 x 9.5)	Self-Laminating TEDLAR	White	DM	PDL-240	106
0.30 x 0.94 (7.6 x 23.8)	0.30 x 0.38 (7.6 x 9.5)	Self-Laminating Vinyl	White	DM	PDL-241	106
0.36 x 0.94 (9.1 x 23.8)	0.36 x 0.38 (9.1 x 9.5)	Self-Laminating TEDLAR	White	DM	PDL-169	106
0.36 x 0.94 (9.1 x 23.8)	0.36 x 0.38 (9.1 x 9.5)	Self-Laminating Vinyl	White	DM	PDL-168	106
0.50 x 0.75 (12.7 x 19.1)	0.50 x 0.34 (12.7 x 8.6)	Self-Laminating Polyester	White	L	PLL-3-Y3-5	70
0.50 x 0.75 (12.7 x 19.1)	0.50 x 0.38 (12.7 x 9.5)	Self-Laminating TEDLAR	White	DM	PDL-118	106
0.50 x 0.75 (12.7 x 19.1)	0.50 x 0.38 (12.7 x 9.5)	Self-Laminating TEDLAR	White	DM	PDL-118-1	106
0.50 x 0.75 (12.7 x 19.1)	0.50 x 0.38 (12.7 x 9.5)	Self-Laminating TEDLAR	White	DM	PDL-118-10	106
0.50 x 0.75 (12.7 x 19.1)	0.50 x 0.38 (12.7 x 9.5)	Self-Laminating TEDLAR	White	DM	PDL-88	106
0.50 x 0.75 (12.7 x 19.1)	0.50 x 0.38 (12.7 x 9.5)	Self-Laminating Vinyl	White	DM	PDL-117	106
0.50 x 0.75 (12.7 x 19.1)	0.50 x 0.38 (12.7 x 9.5)	Self-Laminating Vinyl	White	DM	PDL-42	106
0.50 x 0.75 (12.7 x 19.1)	0.50 x 0.38 (12.7 x 9.5)	Self-Laminating Vinyl	White	DM	PDL-42-10	106
0.50 x 0.75 (12.7 x 19.1)	0.50 x 0.41 (12.7 x 10.4)	Self-Laminating Vinyl	White	TT	TTSL8VC3-10	44
0.50 x 0.94 (12.7 x 23.8)	0.50 x 0.38 (12.7 x 9.5)	Self-Laminating TEDLAR	White	DM	PDL-242	106
0.50 x 0.94 (12.7 x 23.8)	0.50 x 0.38 (12.7 x 9.5)	Self-Laminating Vinyl	White	DM	PDL-243	106
0.50 x 1.38 (12.7 x 34.9)	0.50 x 0.50 (12.7 x 12.7)	Self-Laminating TEDLAR	White	DM	PDL-53-10	106
0.50 x 1.38 (12.7 x 34.9)	0.50 x 0.50 (12.7 x 12.7)	Self-Laminating TEDLAR	White	DM	PDL-53	106
0.50 x 1.38 (12.7 x 34.9)	0.50 x 0.50 (12.7 x 12.7)	Self-Laminating TEDLAR	Blue/White	DM	PDL-53B	106
0.50 x 1.38 (12.7 x 34.9)	0.50 x 0.50 (12.7 x 12.7)	Self-Laminating TEDLAR	Brown/White	DM	PDL-53BR	106
0.50 x 1.38 (12.7 x 34.9)	0.50 x 0.50 (12.7 x 12.7)	Self-Laminating TEDLAR	Green/White	DM	PDL-53G	106
0.50 x 1.38 (12.7 x 34.9)	0.50 x 0.50 (12.7 x 12.7)	Self-Laminating TEDLAR	Gray/White	DM	PDL-53GR	106
0.50 x 1.38 (12.7 x 34.9)	0.50 x 0.50 (12.7 x 12.7)	Self-Laminating TEDLAR	Orange/White	DM	PDL-53OR	106
0.50 x 1.38 (12.7 x 34.9)	0.50 x 0.50 (12.7 x 12.7)	Self-Laminating TEDLAR	Purple/White	DM	PDL-53PR	106
0.50 x 1.38 (12.7 x 34.9)	0.50 x 0.50 (12.7 x 12.7)	Self-Laminating TEDLAR	Red/White	DM	PDL-53R	106
0.50 x 1.38 (12.7 x 34.9)	0.50 x 0.50 (12.7 x 12.7)	Self-Laminating TEDLAR	Yellow/White	DM	PDL-53Y	106
0.50 x 1.44 (12.7 x 36.5)	0.50 x 0.50 (12.7 x 12.7)	Self-Laminating Polyolefin	White	DM	PDL-1VF	106
0.50 x 1.44 (12.7 x 36.5)	0.50 x 0.50 (12.7 x 12.7)	Self-Laminating TEDLAR	White	DM	PDL-61	106
0.50 x 1.44 (12.7 x 36.5)	0.50 x 0.50 (12.7 x 12.7)	Self-Laminating Vinyl	White	DM	PDL-1-1	106
0.50 x 1.44 (12.7 x 36.5)	0.50 x 0.50 (12.7 x 12.7)	Self-Laminating Vinyl	White	DM	PDL-1-10	106
0.50 x 1.44 (12.7 x 36.5)	0.50 x 0.50 (12.7 x 12.7)	Self-Laminating Vinyl	White	DM	PDL-1	106
0.50 x 1.44 (12.7 x 36.5)	0.50 x 0.50 (12.7 x 12.7)	Self-Laminating Vinyl	Blue/White	DM	PDL-1B	106
0.50 x 1.44 (12.7 x 36.5)	0.50 x 0.50 (12.7 x 12.7)	Self-Laminating Vinyl	Brown/White	DM	PDL-1BR	106
0.50 x 1.44 (12.7 x 36.5)	0.50 x 0.50 (12.7 x 12.7)	Self-Laminating Vinyl	Green/White	DM	PDL-1G	106
0.50 x 1.44 (12.7 x 36.5)	0.50 x 0.50 (12.7 x 12.7)	Self-Laminating Vinyl	Gray/White	DM	PDL-1GR	106
0.50 x 1.44 (12.7 x 36.5)	0.50 x 0.50 (12.7 x 12.7)	Self-Laminating Vinyl	Orange/White	DM	PDL-1OR	106
0.50 x 1.44 (12.7 x 36.5)	0.50 x 0.50 (12.7 x 12.7)	Self-Laminating Vinyl	Purple/White	DM	PDL-1PR	106
0.50 x 1.44 (12.7 x 36.5)	0.50 x 0.50 (12.7 x 12.7)	Self-Laminating Vinyl	Red/White	DM	PDL-1R	106
0.50 x 1.44 (12.7 x 36.5)	0.50 x 0.50 (12.7 x 12.7)	Self-Laminating Vinyl	Yellow/white	DM	PDL-1Y	106
0.50 x 1.44 (12.7 x 36.5)	0.50 x 0.50 (12.7 x 12.7)	Self-Laminating Vinyl	White	DM	PDL-12	106
0.50 x 1.50 (12.7 x 38.1)	0.50 x 0.50 (12.7 x 12.7)	Self-Laminating Polyester	White	L	PLL-33-Y3-5	70
0.50 x 1.50 (12.7 x 38.1)	0.50 x 0.50 (12.7 x 12.7)	Self-Laminating Vinyl	White	TT	TTSL1VC3-10	44
0.50 x 2.00 (12.7 x 50.8)	0.50 x 1.00 (12.7 x 25.4)	Self-Laminating Vinyl	White	TT	TTSL10VC3-5	44
0.60 x 1.44 (15.2 x 36.5)	0.60 x 0.50 (15.2 x 12.7)	Self-Laminating Vinyl	White	DM	PDL-6556-2	106
0.70 x 1.33 (17.8 x 33.9)	0.70 x 0.33 (17.8 x 8.5)	Self-Laminating Polyester	White	L	PEL-17-Y3-2.5	71
0.70 x 1.33 (17.8 x 33.9)	0.70 x 0.33 (17.8 x 8.5)	Self-Laminating Polyester	Blue	L	PEL-17-Y3-BLU-2.5	71
0.70 x 1.33 (17.8 x 33.9)	0.70 x 0.33 (17.8 x 8.5)	Self-Laminating Polyester	Brown	L	PEL-17-Y3-BRN-2.5	71
0.70 x 1.33 (17.8 x 33.9)	0.70 x 0.33 (17.8 x 8.5)	Self-Laminating Polyester	Green	L	PEL-17-Y3-GRN-2.5	71
0.70 x 1.33 (17.8 x 33.9)	0.70 x 0.33 (17.8 x 8.5)	Self-Laminating Polyester	Gray	L	PEL-17-Y3-GRY-2.5	71
0.70 x 1.33 (17.8 x 33.9)	0.70 x 0.33 (17.8 x 8.5)	Self-Laminating Polyester	Orange	L	PEL-17-Y3-ORN-2.5	71
0.70 x 1.33 (17.8 x 33.9)	0.70 x 0.33 (17.8 x 8.5)	Self-Laminating Polyester	Purple	L	PEL-17-Y3-PUR-2.5	71
0.70 x 1.33 (17.8 x 33.9)	0.70 x 0.33 (17.8 x 8.5)	Self-Laminating Polyester	Red	L	PEL-17-Y3-RED-2.5	71

* DM = Dot-Matrix, IJ = Ink Jet, L = Laser, TT = Thermal Transfer
 ^TEDLAR is a registered trademark of E.I. DuPont Co.

Self-Laminating Labels by Size (cont.)

Label Size Width x Length In. (mm)	Print-On Area Size Width x Length In. (mm)	Material	Print-On Area Color	Print Method*	Part Number	Page No.
0.70 x 1.33 (17.8 x 33.9)	0.70 x 0.33 (17.8 x 8.5)	Self-Laminating Polyester	Yellow	L	PEL-17-Y3-YEL-2.5	71
0.75 x 1.75 (19.1 x 44.5)	0.75 x 0.50 (19.1 x 12.7)	Self-Laminating TEDLAR [▲]	White	DM	PDL-244	107
0.75 x 1.75 (19.1 x 44.5)	0.75 x 0.50 (19.1 x 12.7)	Self-Laminating Vinyl	White	DM	PDL-245	107
0.75 x 1.75 (19.1 x 44.5)	0.75 x 0.50 (19.1 x 12.7)	Self-Laminating Vinyl	White	DM	PDL-245-1	107
0.75 x 1.75 (19.1 x 44.5)	0.75 x 0.50 (19.1 x 12.7)	Self-Laminating Vinyl	White	DM	PDL-245-10	107
0.80 x 0.94 (20.3x 23.9)	0.80 x 0.38 (20.3 x 9.6)	Self-Laminating Vinyl	White	TT	TTSL247VC3-10	44
0.80 x 0.94 (20.3 x 23.8)	0.80 x 0.38 (20.3 x 9.5)	Self-Laminating TEDLAR	White	DM	PDL-246	107
0.80 x 0.94 (20.3 x 23.8)	0.80 x 0.38 (20.3 x 9.5)	Self-Laminating Vinyl	White	DM	PDL-247	107
0.80 x 1.44 (20.3 x 36.5)	0.80 x 0.50 (20.3 x 12.7)	Self-Laminating Polyolefin	White	DM	PDL-8VF	107
0.80 x 1.44 (20.3 x 36.5)	0.80 x 0.50 (20.3 x 12.7)	Self-Laminating TEDLAR	White	DM	PDL-60	107
0.80 x 1.44 (20.3 x 36.5)	0.80 x 0.50 (20.3 x 12.7)	Self-Laminating TEDLAR	Blue/White	DM	PDL-60B	107
0.80 x 1.44 (20.3 x 36.5)	0.80 x 0.50 (20.3 x 12.7)	Self-Laminating TEDLAR	Brown/White	DM	PDL-60BR	107
0.80 x 1.44 (20.3 x 36.5)	0.80 x 0.50 (20.3 x 12.7)	Self-Laminating TEDLAR	Green/White	DM	PDL-60G	107
0.80 x 1.44 (20.3 x 36.5)	0.80 x 0.50 (20.3 x 12.7)	Self-Laminating TEDLAR	Gray/White	DM	PDL-60GR	107
0.80 x 1.44 (20.3 x 36.5)	0.80 x 0.50 (20.3 x 12.7)	Self-Laminating TEDLAR	Orange/White	DM	PDL-60OR	107
0.80 x 1.44 (20.3 x 36.5)	0.80 x 0.50 (20.3 x 12.7)	Self-Laminating TEDLAR	Purple/White	DM	PDL-60PR	107
0.80 x 1.44 (20.3 x 36.5)	0.80 x 0.50 (20.3 x 12.7)	Self-Laminating TEDLAR	Red/White	DM	PDL-60R	107
0.80 x 1.44 (20.3 x 36.5)	0.80 x 0.50 (20.3 x 12.7)	Self-Laminating TEDLAR	Yellow/White	DM	PDL-60Y	107
0.80 x 1.44 (20.3 x 36.5)	0.80 x 0.50 (20.3 x 12.7)	Self-Laminating Vinyl	White	DM	PDL-8-1	107
0.80 x 1.44 (20.3 x 36.5)	0.80 x 0.50 (20.3 x 12.7)	Self-Laminating Vinyl	White	DM	PDL-8-10	107
0.80 x 1.44 (20.3 x 36.5)	0.80 x 0.50 (20.3 x 12.7)	Self-Laminating Vinyl	White	DM	PDL-8	107
0.80 x 1.44 (20.3 x 36.5)	0.80 x 0.50 (20.3 x 12.7)	Self-Laminating Vinyl	Blue/White	DM	PDL-8B	107
0.80 x 1.44 (20.3 x 36.5)	0.80 x 0.50 (20.3 x 12.7)	Self-Laminating Vinyl	Brown/White	DM	PDL-8BR	107
0.80 x 1.44 (20.3 x 36.5)	0.80 x 0.50 (20.3 x 12.7)	Self-Laminating Vinyl	Green/White	DM	PDL-8G	107
0.80 x 1.44 (20.3 x 36.5)	0.80 x 0.50 (20.3 x 12.7)	Self-Laminating Vinyl	Gray/White	DM	PDL-8GR	107
0.80 x 1.44 (20.3 x 36.5)	0.80 x 0.50 (20.3 x 12.7)	Self-Laminating Vinyl	Orange/White	DM	PDL-8OR	107
0.80 x 1.44 (20.3 x 36.5)	0.80 x 0.50 (20.3 x 12.7)	Self-Laminating Vinyl	Purple/White	DM	PDL-8PR	107
0.80 x 1.44 (20.3 x 36.5)	0.80 x 0.50 (20.3 x 12.7)	Self-Laminating Vinyl	Red/White	DM	PDL-8R	107
0.80 x 1.44 (20.3 x 36.5)	0.80 x 0.50 (20.3 x 12.7)	Self-Laminating Vinyl	Yellow/White	DM	PDL-8Y	107
0.82 x 2.00 (20.8 x 50.8)	0.82 x 0.63 (20.8 x 15.9)	Self-Laminating Vinyl	White	DM	PDL-5859-2	107
0.82 x 2.00 (20.8 x 50.8)	0.82 x 0.63 (20.8 x 15.9)	Self-Laminating Vinyl	Yellow	DM	PDL-5859-4	107
0.90 x 2.17 (22.9 x 55.0)	0.90 x 0.50 (22.9 x 12.7)	Self-Laminating Polyester	White	L	PEL-18-Y3-1	71
0.90 x 2.17 (22.9 x 55.0)	0.90 x 0.50 (22.9 x 12.7)	Self-Laminating Polyester	Blue	L	PEL-18-Y3-BLU-1	71
0.90 x 2.17 (22.9 x 55.0)	0.90 x 0.50 (22.9 x 12.7)	Self-Laminating Polyester	Brown	L	PEL-18-Y3-BRN-1	71
0.90 x 2.17 (22.9 x 55.0)	0.90 x 0.50 (22.9 x 12.7)	Self-Laminating Polyester	Green	L	PEL-18-Y3-GRN-1	71
0.90 x 2.17 (22.9 x 55.0)	0.90 x 0.50 (22.9 x 12.7)	Self-Laminating Polyester	Gray	L	PEL-18-Y3-GRY-1	71
0.90 x 2.17 (22.9 x 55.0)	0.90 x 0.50 (22.9 x 12.7)	Self-Laminating Polyester	Orange	L	PEL-18-Y3-ORN-1	71
0.90 x 2.17 (22.9 x 55.0)	0.90 x 0.50 (22.9 x 12.7)	Self-Laminating Polyester	Purple	L	PEL-18-Y3-PUR-1	71
0.90 x 2.17 (22.9 x 55.0)	0.90 x 0.50 (22.9 x 12.7)	Self-Laminating Polyester	Red	L	PEL-18-Y3-RED-1	71
0.90 x 2.17 (22.9 x 55.0)	0.90 x 0.50 (22.9 x 12.7)	Self-Laminating Polyester	Yellow	L	PEL-18-Y3-YEL-1	71
0.90 x 2.17 (22.9 x 55.0)	0.90 x 0.50 (22.9 x 12.7)	Self-Laminating Polyolefin	White	L	PEL-18-PO3-1	71
1.00 x 0.75 (25.4 x 19.1)	1.00 x 0.34 (25.4 x 8.6)	Self-Laminating Polyester	White	L	PLL-10-Y3-2.5	70
1.00 x 0.75 (25.4 x 19.1)	1.00 x 0.34 (25.4 x 8.6)	Self-Laminating Polyester	White	L	PLL-10-Y3-5	70
1.00 x 0.75 (25.4 x 19.1)	1.00 x 0.35 (25.4 x 8.9)	Self-Laminating Vinyl	White	TT	TTSL-9VC3-10	44
1.00 x 0.75 (25.4 x 19.1)	1.00 x 0.38 (25.4 x 9.5)	Self-Laminating Polyolefin	White	DM	PDL-249VF	107
1.00 x 0.75 (25.4 x 19.1)	1.00 x 0.38 (25.4 x 9.5)	Self-Laminating TEDLAR	White	DM	PDL-248	107
1.00 x 0.75 (25.4 x 19.1)	1.00 x 0.38 (25.4 x 9.5)	Self-Laminating Vinyl	White	DM	PDL-249	107
1.00 x 0.75 (25.4 x 19.1)	1.00 x 0.38 (25.4 x 9.5)	Self-Laminating Vinyl	White	DM	PDL-249-1	107
1.00 x 0.75 (25.4 x 19.1)	1.00 x 0.38 (25.4 x 9.5)	Self-Laminating Vinyl	White	DM	PDL-249-10	107
1.00 x 0.94 (25.4 x 23.8)	1.00 x 0.38 (25.4 x 9.5)	Self-Laminating TEDLAR	White	DM	PDL-250	107
1.00 x 0.94 (25.4 x 23.8)	1.00 x 0.38 (25.4 x 9.5)	Self-Laminating Vinyl	White	DM	PDL-251	107
1.00 x 1.00 (25.4 x 25.4)	1.00 x 0.34 (25.4 x 8.6)	Self-Laminating Polyester	White	L	PLL-11-Y3-2.5	70
1.00 x 1.00 (25.4 x 25.4)	1.00 x 0.34 (25.4 x 8.6)	Self-Laminating Polyester	Blue	L	PLL-11-Y3B-2.5	70
1.00 x 1.00 (25.4 x 25.4)	1.00 x 0.34 (25.4 x 8.6)	Self-Laminating Polyester	Brown	L	PLL-11-YBR3-2.5	70

* DM = Dot-Matrix, IJ = Ink Jet, L = Laser, TT = Thermal Transfer
[▲] TEDLAR is a registered trademark of E.I. DuPont Co.

Self-Laminating Labels by Size (cont.)

Label Size Width x Length In. (mm)	Print-On Area Size Width x Length In. (mm)	Material	Print-On Area Color	Print Method*	Part Number	Page No.
1.00 x 1.00 (25.4 x 25.4)	1.00 x 0.34 (25.4 x 8.6)	Self-Laminating Polyester	Green	L	PLL-11-Y3G-2.5	70
1.00 x 1.00 (25.4 x 25.4)	1.00 x 0.34 (25.4 x 8.6)	Self-Laminating Polyester	Gray	L	PLL-11-Y3IG-2.5	70
1.00 x 1.00 (25.4 x 25.4)	1.00 x 0.34 (25.4 x 8.6)	Self-Laminating Polyester	Orange	L	PLL-11-Y3OR-2.5	70
1.00 x 1.00 (25.4 x 25.4)	1.00 x 0.34 (25.4 x 8.6)	Self-Laminating Polyester	Purple	L	PLL-11-Y3PR-2.5	70
1.00 x 1.00 (25.4 x 25.4)	1.00 x 0.34 (25.4 x 8.6)	Self-Laminating Polyester	Red	L	PLL-11-Y3RD-2.5	70
1.00 x 1.00 (25.4 x 25.4)	1.00 x 0.34 (25.4 x 8.6)	Self-Laminating Polyester	Yellow	L	PLL-11-Y3YL-2.5	70
1.00 x 1.33 (25.4 x 33.8)	1.00 x 0.50 (25.4 x 12.7)	Self-Laminating Polyester	White	L	PLL-12-Y3-1	70
1.00 x 1.33 (25.4 x 33.8)	1.00 x 0.50 (25.4 x 12.7)	Self-Laminating Polyester	White	L	PLL-12-Y3-2.5	70
1.00 x 1.33 (25.4 x 33.8)	1.00 x 0.50 (25.4 x 12.7)	Self-Laminating Polyester	Blue	L	PLL-12-Y3-2.5	70
1.00 x 1.33 (25.4 x 33.8)	1.00 x 0.50 (25.4 x 12.7)	Self-Laminating Polyester	Brown	L	PLL-12-Y3B-2.5	70
1.00 x 1.33 (25.4 x 33.8)	1.00 x 0.50 (25.4 x 12.7)	Self-Laminating Polyester	Green	L	PLL-12-YBR3-2.5	70
1.00 x 1.33 (25.4 x 33.8)	1.00 x 0.50 (25.4 x 12.7)	Self-Laminating Polyester	Gray	L	PLL-12-Y3G-2.5	70
1.00 x 1.33 (25.4 x 33.8)	1.00 x 0.50 (25.4 x 12.7)	Self-Laminating Polyester	Orange	L	PLL-12-Y3IG-2.5	70
1.00 x 1.33 (25.4 x 33.8)	1.00 x 0.50 (25.4 x 12.7)	Self-Laminating Polyester	Purple	L	PLL-12-Y3OR-2.5	70
1.00 x 1.33 (25.4 x 33.8)	1.00 x 0.50 (25.4 x 12.7)	Self-Laminating Polyester	Red	L	PLL-12-Y3RD-2.5	70
1.00 x 1.33 (25.4 x 33.8)	1.00 x 0.50 (25.4 x 12.7)	Self-Laminating Polyester	Yellow	L	PLL-12-Y3RD-2.5	70
1.00 x 1.33 (25.4 x 33.8)	1.00 x 0.50 (25.4 x 12.7)	Self-Laminating Polyester	White	L	PLL-39-Y3-1	70
1.00 x 1.38 (25.4 x 34.9)	1.00 x 0.50 (25.4 x 12.7)	Self-Laminating TEDLAR ▲	White	DM	PDL-54	108
1.00 x 1.38 (25.4 x 34.9)	1.00 x 0.50 (25.4 x 12.7)	Self-Laminating TEDLAR	Blue/White	DM	PDL-54B	108
1.00 x 1.38 (25.4 x 34.9)	1.00 x 0.50 (25.4 x 12.7)	Self-Laminating TEDLAR	Brown/White	DM	PDL-54BR	108
1.00 x 1.38 (25.4 x 34.9)	1.00 x 0.50 (25.4 x 12.7)	Self-Laminating TEDLAR	Green/White	DM	PDL-54G	108
1.00 x 1.38 (25.4 x 34.9)	1.00 x 0.50 (25.4 x 12.7)	Self-Laminating TEDLAR	Gray/White	DM	PDL-54GR	108
1.00 x 1.38 (25.4 x 34.9)	1.00 x 0.50 (25.4 x 12.7)	Self-Laminating TEDLAR	Orange/White	DM	PDL-54OR	108
1.00 x 1.38 (25.4 x 34.9)	1.00 x 0.50 (25.4 x 12.7)	Self-Laminating TEDLAR	Purple/White	DM	PDL-54PR	108
1.00 x 1.38 (25.4 x 34.9)	1.00 x 0.50 (25.4 x 12.7)	Self-Laminating TEDLAR	Red/White	DM	PDL-54R	108
1.00 x 1.38 (25.4 x 34.9)	1.00 x 0.50 (25.4 x 12.7)	Self-Laminating TEDLAR	Yellow/White	DM	PDL-54Y	108
1.00 x 1.44 (25.4 x 36.5)	1.00 x 0.50 (25.4 x 12.7)	Self-Laminating Polyolefin	White	DM	PDL-2VF	108
1.00 x 1.44 (25.4 x 36.5)	1.00 x 0.50 (25.4 x 12.7)	Self-Laminating Vinyl	White	DM	PDL-2-1	108
1.00 x 1.44 (25.4 x 36.5)	1.00 x 0.50 (25.4 x 12.7)	Self-Laminating Vinyl	White	DM	PDL-2-10	108
1.00 x 1.44 (25.4 x 36.5)	1.00 x 0.50 (25.4 x 12.7)	Self-Laminating Vinyl	White	DM	PDL-2	108
1.00 x 1.44 (25.4 x 36.5)	1.00 x 0.50 (25.4 x 12.7)	Self-Laminating Vinyl	Blue/White	DM	PDL-2B	108
1.00 x 1.44 (25.4 x 36.5)	1.00 x 0.50 (25.4 x 12.7)	Self-Laminating Vinyl	Brown/White	DM	PDL-2BR	108
1.00 x 1.44 (25.4 x 36.5)	1.00 x 0.50 (25.4 x 12.7)	Self-Laminating Vinyl	Green/White	DM	PDL-2G	108
1.00 x 1.44 (25.4 x 36.5)	1.00 x 0.50 (25.4 x 12.7)	Self-Laminating Vinyl	Gray/White	DM	PDL-2GR	108
1.00 x 1.44 (25.4 x 36.5)	1.00 x 0.50 (25.4 x 12.7)	Self-Laminating Vinyl	Orange/White	DM	PDL-2OR	108
1.00 x 1.44 (25.4 x 36.5)	1.00 x 0.50 (25.4 x 12.7)	Self-Laminating Vinyl	Purple/White	DM	PDL-2PR	108
1.00 x 1.44 (25.4 x 36.5)	1.00 x 0.50 (25.4 x 12.7)	Self-Laminating Vinyl	Red/White	DM	PDL-2R	108
1.00 x 1.44 (25.4 x 36.5)	1.00 x 0.50 (25.4 x 12.7)	Self-Laminating Vinyl	Yellow/White	DM	PDL-2Y	108
1.00 x 1.44 (25.4 x 36.5)	1.00 x 0.62 (25.4 x 15.8)	Self-Laminating Vinyl	White	DM	PDL-9025-10	108
1.00 x 1.50 (25.4 x 38.1)	1.00 x 0.50 (25.4 x 12.7)	Self-Laminating Vinyl	White	TT	TTSL2VC3-10	44
1.00 x 2.44 (25.4 x 61.9)	1.00 x 0.75 (25.4 x 19.1)	Self-Laminating Polyolefin	White	DM	PDL-4VF	108
1.00 x 2.44 (25.4 x 61.9)	1.00 x 0.75 (25.4 x 19.1)	Self-Laminating TEDLAR	White	DM	PDL-56	108
1.00 x 2.44 (25.4 x 61.9)	1.00 x 0.75 (25.4 x 19.1)	Self-Laminating TEDLAR	Blue/White	DM	PDL-56B	108
1.00 x 2.44 (25.4 x 61.9)	1.00 x 0.75 (25.4 x 19.1)	Self-Laminating TEDLAR	Brown/White	DM	PDL-56BR	108
1.00 x 2.44 (25.4 x 61.9)	1.00 x 0.75 (25.4 x 19.1)	Self-Laminating TEDLAR	Green/White	DM	PDL-56G	108
1.00 x 2.44 (25.4 x 61.9)	1.00 x 0.75 (25.4 x 19.1)	Self-Laminating TEDLAR	Gray/White	DM	PDL-56GR	108
1.00 x 2.44 (25.4 x 61.9)	1.00 x 0.75 (25.4 x 19.1)	Self-Laminating TEDLAR	Orange/White	DM	PDL-56OR	108
1.00 x 2.44 (25.4 x 61.9)	1.00 x 0.75 (25.4 x 19.1)	Self-Laminating TEDLAR	Purple/White	DM	PDL-56PR	108
1.00 x 2.44 (25.4 x 61.9)	1.00 x 0.75 (25.4 x 19.1)	Self-Laminating TEDLAR	Red/White	DM	PDL-56R	108
1.00 x 2.44 (25.4 x 61.9)	1.00 x 0.75 (25.4 x 19.1)	Self-Laminating TEDLAR	Yellow/White	DM	PDL-56Y	108
1.00 x 2.44 (25.4 x 61.9)	1.00 x 0.75 (25.4 x 19.1)	Self-Laminating Vinyl	White	DM	PDL-4-10	108
1.00 x 2.44 (25.4 x 61.9)	1.00 x 0.75 (25.4 x 19.1)	Self-Laminating Vinyl	White	DM	PDL-4	108
1.00 x 2.44 (25.4 x 61.9)	1.00 x 0.75 (25.4 x 19.1)	Self-Laminating Vinyl	Blue/White	DM	PDL-4B	108
1.00 x 2.44 (25.4 x 61.9)	1.00 x 0.75 (25.4 x 19.1)	Self-Laminating Vinyl	Brown/White	DM	PDL-4BR	108

* DM = Dot-Matrix, IJ = Ink Jet, L = Laser, TT = Thermal Transfer
 ▲TEDLAR is a registered trademark of E.I. DuPont Co.

Self-Laminating Labels by Size (cont.)

Label Size Width x Length In. (mm)	Print-On Area Size Width x Length In. (mm)	Material	Print-On Area Color	Print Method*	Part Number	Page No.
1.00 x 2.44 (25.4 x 61.9)	1.00 x 0.75 (25.4 x 19.1)	Self-Laminating Vinyl	Green/White	DM	PDL-4G	108
1.00 x 2.44 (25.4 x 61.9)	1.00 x 0.75 (25.4 x 19.1)	Self-Laminating Vinyl	Gray/White	DM	PDL-4GR	108
1.00 x 2.44 (25.4 x 61.9)	1.00 x 0.75 (25.4 x 19.1)	Self-Laminating Vinyl	Orange/White	DM	PDL-4OR	108
1.00 x 2.44 (25.4 x 61.9)	1.00 x 0.75 (25.4 x 19.1)	Self-Laminating Vinyl	Purple/White	DM	PDL-4PR	108
1.00 x 2.44 (25.4 x 61.9)	1.00 x 0.75 (25.4 x 19.1)	Self-Laminating Vinyl	Red/White	DM	PDL-4R	108
1.00 x 2.44 (25.4 x 61.9)	1.00 x 0.75 (25.4 x 19.1)	Self-Laminating Vinyl	Yellow/White	DM	PDL-4Y	108
1.00 x 2.44 (25.4 x 62.0)	1.00 x 1.00 (25.4 x 25.4)	Self-Laminating Vinyl	White	TT	TTSL4VC3-5	44
1.00 x 2.67 (25.4 x 67.7)	1.00 x 0.67 (25.4 x 16.9)	Self-Laminating Polyester	White	L	PEL-19-Y3-1	71
1.00 x 2.67 (25.4 x 67.7)	1.00 x 0.67 (25.4 x 16.9)	Self-Laminating Polyester	Blue	L	PEL-19-Y3-BLU-1	71
1.00 x 2.67 (25.4 x 67.7)	1.00 x 0.67 (25.4 x 16.9)	Self-Laminating Polyester	Brown	L	PEL-19-Y3-BRN-1	71
1.00 x 2.67 (25.4 x 67.7)	1.00 x 0.67 (25.4 x 16.9)	Self-Laminating Polyester	Green	L	PEL-19-Y3-GRN-1	71
1.00 x 2.67 (25.4 x 67.7)	1.00 x 0.67 (25.4 x 16.9)	Self-Laminating Polyester	Gray	L	PEL-19-Y3-GRY-1	71
1.00 x 2.67 (25.4 x 67.7)	1.00 x 0.67 (25.4 x 16.9)	Self-Laminating Polyester	Orange	L	PEL-19-Y3-ORN-1	71
1.00 x 2.67 (25.4 x 67.7)	1.00 x 0.67 (25.4 x 16.9)	Self-Laminating Polyester	Purple	L	PEL-19-Y3-PUR-1	71
1.00 x 2.67 (25.4 x 67.7)	1.00 x 0.67 (25.4 x 16.9)	Self-Laminating Polyester	Red	L	PEL-19-Y3-RED-1	71
1.00 x 2.67 (25.4 x 67.7)	1.00 x 0.67 (25.4 x 16.9)	Self-Laminating Polyester	Yellow	L	PEL-19-Y3-YEL-1	71
1.00 x 3.17 (25.4 x 80.5)	1.00 x 0.97 (25.4 x 24.6)	Self-Laminating Polyester	White	L	PLL-13-Y3-1	70
1.00 x 3.17 (25.4 x 80.5)	1.00 x 0.97 (25.4 x 24.6)	Self-Laminating Polyester	White	L	PLL-13-Y3-D	70
1.00 x 3.87 (25.4 x 98.3)	1.00 x 1.00 (25.4 x 25.4)	Self-Laminating TEDLAR ▲	White	DM	PDL-58	109
1.00 x 3.87 (25.4 x 98.3)	1.00 x 1.00 (25.4 x 25.4)	Self-Laminating TEDLAR	Blue/White	DM	PDL-58B	109
1.00 x 3.87 (25.4 x 98.3)	1.00 x 1.00 (25.4 x 25.4)	Self-Laminating TEDLAR	Brown/White	DM	PDL-58BR	109
1.00 x 3.87 (25.4 x 98.3)	1.00 x 1.00 (25.4 x 25.4)	Self-Laminating TEDLAR	Green/White	DM	PDL-58G	109
1.00 x 3.87 (25.4 x 98.3)	1.00 x 1.00 (25.4 x 25.4)	Self-Laminating TEDLAR	Gray/White	DM	PDL-58GR	109
1.00 x 3.87 (25.4 x 98.3)	1.00 x 1.00 (25.4 x 25.4)	Self-Laminating TEDLAR	Orange/White	DM	PDL-58OR	109
1.00 x 3.87 (25.4 x 98.3)	1.00 x 1.00 (25.4 x 25.4)	Self-Laminating TEDLAR	Purple/White	DM	PDL-58PR	109
1.00 x 3.87 (25.4 x 98.3)	1.00 x 1.00 (25.4 x 25.4)	Self-Laminating TEDLAR	Red/White	DM	PDL-58R	109
1.00 x 3.87 (25.4 x 98.3)	1.00 x 1.00 (25.4 x 25.4)	Self-Laminating TEDLAR	Yellow/White	DM	PDL-58Y	109
1.00 x 3.94 (25.4 x 100.1)	1.00 x 1.00 (25.4 x 25.4)	Self-Laminating Polyolefin	White	DM	PDL-6VF	109
1.00 x 3.94 (25.4 x 100.1)	1.00 x 1.00 (25.4 x 25.4)	Self-Laminating Vinyl	White	DM	PDL-6-10	109
1.00 x 3.94 (25.4 x 100.1)	1.00 x 1.00 (25.4 x 25.4)	Self-Laminating Vinyl	White	DM	PDL-6-2.5	109
1.00 x 3.94 (25.4 x 100.1)	1.00 x 1.00 (25.4 x 25.4)	Self-Laminating Vinyl	White	DM	PDL-6	109
1.00 x 3.94 (25.4 x 100.1)	1.00 x 1.00 (25.4 x 25.4)	Self-Laminating Vinyl	Blue/White	DM	PDL-6B	109
1.00 x 3.94 (25.4 x 100.1)	1.00 x 1.00 (25.4 x 25.4)	Self-Laminating Vinyl	Brown/White	DM	PDL-6BR	109
1.00 x 3.94 (25.4 x 100.1)	1.00 x 1.00 (25.4 x 25.4)	Self-Laminating Vinyl	Green/White	DM	PDL-6G	109
1.00 x 3.94 (25.4 x 100.1)	1.00 x 1.00 (25.4 x 25.4)	Self-Laminating Vinyl	Gray/White	DM	PDL-6GR	109
1.00 x 3.94 (25.4 x 100.1)	1.00 x 1.00 (25.4 x 25.4)	Self-Laminating Vinyl	Orange/White	DM	PDL-6OR	109
1.00 x 3.94 (25.4 x 100.1)	1.00 x 1.00 (25.4 x 25.4)	Self-Laminating Vinyl	Purple/White	DM	PDL-6PR	109
1.00 x 3.94 (25.4 x 100.1)	1.00 x 1.00 (25.4 x 25.4)	Self-Laminating Vinyl	Red/White	DM	PDL-6R	109
1.00 x 3.94 (25.4 x 100.1)	1.00 x 1.00 (25.4 x 25.4)	Self-Laminating Vinyl	Yellow/White	DM	PDL-6Y	109
1.00 x 3.94 (25.4 x 100.1)	1.00 x 1.00 (25.4 x 25.4)	Self-Laminating Vinyl	White	TT	TTSL6V3-2.5	44
1.00 x 5.45 (25.4 x 138.4)	1.00 x 1.00 (25.4 x 25.4)	Self-Laminating Polyester	White	L	PLL-38-Y3-1	70
1.00 x 5.94 (25.4 x 150.9)	1.00 x 1.50 (25.4 x 38.1)	Self-Laminating TEDLAR	White	DM	PDL-123	109
1.00 x 5.94 (25.4 x 150.9)	1.00 x 1.50 (25.4 x 38.1)	Self-Laminating TEDLAR	White	DM	PDL-95	109
1.00 x 5.94 (25.4 x 150.9)	1.00 x 1.50 (25.4 x 38.1)	Self-Laminating Vinyl	White	DM	PDL-124	109
1.00 x 5.94 (25.4 x 150.9)	1.00 x 1.50 (25.4 x 38.1)	Self-Laminating Vinyl	White	DM	PDL-124-10	109
1.00 x 5.94 (25.4 x 150.9)	1.00 x 1.50 (25.4 x 38.1)	Self-Laminating Vinyl	White	DM	PDL-124-2.5	109
1.00 x 5.94 (25.4 x 150.9)	1.00 x 1.50 (25.4 x 38.1)	Self-Laminating Vinyl	White	DM	PDL-51	109
1.00 x 7.44 (25.4 x 189.0)	1.00 x 1.50 (25.4 x 38.1)	Self-Laminating TEDLAR	White	DM	PDL-125	109
1.00 x 7.44 (25.4 x 189.0)	1.00 x 1.50 (25.4 x 38.1)	Self-Laminating TEDLAR	White	DM	PDL-96	109
1.00 x 7.44 (25.4 x 189.0)	1.00 x 1.50 (25.4 x 38.1)	Self-Laminating Vinyl	White	DM	PDL-126	109
1.00 x 7.44 (25.4 x 189.0)	1.00 x 1.50 (25.4 x 38.1)	Self-Laminating Vinyl	White	DM	PDL-126-10	109
1.00 x 7.44 (25.4 x 189.0)	1.00 x 1.50 (25.4 x 38.1)	Self-Laminating Vinyl	White	DM	PDL-52	109
1.00 x 7.44 (25.4 x 189.0)	1.00 x 1.50 (25.4 x 38.1)	Self-Laminating Vinyl	White	DM	PDL-52-2.5	109
1.13 x 3.75 (28.6 x 95.3)	1.13 x 1.25 (28.6 x 31.8)	Self-Laminating Vinyl	White	DM	PDL-5859-1	109

* DM = Dot-Matrix, IJ = Ink Jet, L = Laser, TT = Thermal Transfer
 ▲TEDLAR is a registered trademark of E.I DuPont Co.

Self-Laminating Labels by Size (cont.)

Label Size Width x Length In. (mm)	Print-On Area Size Width x Length In. (mm)	Material	Print-On Area Color	Print Method*	Part Number	Page No.
1.13 x 3.75 (28.6 x 95.3)	1.13 x 1.25 (28.6 x 31.8)	Self-Laminating Vinyl	Yellow	DM	PDL-5859-3	109
1.17 x 3.00 (29.6 x 76.2)	1.17 x 0.83 (29.6 x 21.2)	Self-Laminating Vinyl	White	DM	CCS-WHT	109
1.17 x 3.00 (29.6 x 76.2)	1.17 x 0.83 (29.6 x 21.2)	Self-Laminating Vinyl	Yellow	DM	CCS-YEL	109
1.20 x 2.25 (30.5 x 57.2)	1.20 x 0.60 (30.5 x 15.2)	Self-Laminating Vinyl	White	DM	PDL-6626-10	109
1.20 x 2.67 (30.5 x 67.7)	1.20 x 0.83 (30.5 x 21.2)	Self-Laminating Polyester	White	L	PEL-20-Y3-1	71
1.40 x 3.67 (35.6 x 93.1)	1.40 x 1.00 (35.6 x 25.4)	Self-Laminating Polyester	White	L	PEL-21-Y3-0.5	71
1.40 x 3.67 (35.6 x 93.1)	1.40 x 1.00 (35.6 x 25.4)	Self-Laminating Polyester	Blue	L	PEL-21-Y3-BLU-0.5	71
1.40 x 3.67 (35.6 x 93.1)	1.40 x 1.00 (35.6 x 25.4)	Self-Laminating Polyester	Brown	L	PEL-21-Y3-BRN-0.5	71
1.40 x 3.67 (35.6 x 93.1)	1.40 x 1.00 (35.6 x 25.4)	Self-Laminating Polyester	Green	L	PEL-21-Y3-GRN-0.5	71
1.40 x 3.67 (35.6 x 93.1)	1.40 x 1.00 (35.6 x 25.4)	Self-Laminating Polyester	Gray	L	PEL-21-Y3-GRY-0.5	71
1.40 x 3.67 (35.6 x 93.1)	1.40 x 1.00 (35.6 x 25.4)	Self-Laminating Polyester	Orange	L	PEL-21-Y3-ORN-0.5	71
1.40 x 3.67 (35.6 x 93.1)	1.40 x 1.00 (35.6 x 25.4)	Self-Laminating Polyester	Purple	L	PEL-21-Y3-PUR-0.5	71
1.40 x 3.67 (35.6 x 93.1)	1.40 x 1.00 (35.6 x 25.4)	Self-Laminating Polyester	Red	L	PEL-21-Y3-RED-0.5	71
1.40 x 3.67 (35.6 x 93.1)	1.40 x 1.00 (35.6 x 25.4)	Self-Laminating Polyester	Yellow	L	PEL-21-Y3-YEL-0.5	71
1.40 x 5.50 (35.6 x 140.0)	1.40 x 1.00 (35.6 x 25.4)	Self-Laminating Polyester	White	L	PEL-22-Y3-0.5	71
1.50 x 2.25 (38.1 x 57.2)	1.50 x 0.50 (38.1 x 12.7)	Self-Laminating Vinyl	White	DM	PDL-3523-1	109
1.50 x 3.63 (38.1 x 92.1)	1.50 x 0.80 (38.1 x 20.3)	Self-Laminating Vinyl	White	DM	PDL-361-1	109
1.80 x 5.50 (45.7 x 140.0)	1.80 x 1.17 (45.7 x 29.6)	Self-Laminating Polyester	White	L	PEL-23-Y3-0.5	71
1.88 x 3.17 (47.6 x 80.5)	1.88 x 0.97 (47.6 x 24.6)	Self-Laminating Polyester	White	L	PLL-37-Y3-1	70
1.90 x 3.19 (48.3 x 81.0)	1.90 x 0.75 (48.3 x 19.1)	Self-Laminating TEDLAR ▲	White	DM	PDL-108	110
1.90 x 3.19 (48.3 x 81.0)	1.90 x 0.75 (48.3 x 19.1)	Self-Laminating TEDLAR	White	DM	PDL-64	110
1.90 x 3.19 (48.3 x 81.0)	1.90 x 0.75 (48.3 x 19.1)	Self-Laminating Vinyl	White	DM	PDL-109	110
1.90 x 3.19 (48.3 x 81.0)	1.90 x 0.75 (48.3 x 19.1)	Self-Laminating Vinyl	White	DM	PDL-109-2.5	110
1.90 x 3.19 (48.3 x 81.0)	1.90 x 0.75 (48.3 x 19.1)	Self-Laminating Vinyl	White	DM	PDL-18	110
1.90 x 3.19 (48.3 x 81.0)	1.90 x 0.75 (48.3 x 19.1)	Self-Laminating Vinyl	White	DM	PDL-18-10	110
1.90 x 3.19 (48.3 x 81.0)	1.90 x 0.75 (48.3 x 19.1)	Self-Laminating Vinyl	White	DM	PDL-18-2.5	110
2.00 x 1.38 (50.8 x 34.9)	2.00 x 0.50 (50.8 x 12.7)	Self-Laminating TEDLAR	White	DM	PDL-55	110
2.00 x 1.38 (50.8 x 34.9)	2.00 x 0.50 (50.8 x 12.7)	Self-Laminating TEDLAR	Blue/White	DM	PDL-55B	110
2.00 x 1.38 (50.8 x 34.9)	2.00 x 0.50 (50.8 x 12.7)	Self-Laminating TEDLAR	Brown/White	DM	PDL-55BR	110
2.00 x 1.38 (50.8 x 34.9)	2.00 x 0.50 (50.8 x 12.7)	Self-Laminating TEDLAR	Green/White	DM	PDL-55G	110
2.00 x 1.38 (50.8 x 34.9)	2.00 x 0.50 (50.8 x 12.7)	Self-Laminating TEDLAR	Gray/White	DM	PDL-55GR	110
2.00 x 1.38 (50.8 x 34.9)	2.00 x 0.50 (50.8 x 12.7)	Self-Laminating TEDLAR	Orange/White	DM	PDL-55OR	110
2.00 x 1.38 (50.8 x 34.9)	2.00 x 0.50 (50.8 x 12.7)	Self-Laminating TEDLAR	Purple/White	DM	PDL-55PR	110
2.00 x 1.38 (50.8 x 34.9)	2.00 x 0.50 (50.8 x 12.7)	Self-Laminating TEDLAR	Red/White	DM	PDL-55R	110
2.00 x 1.38 (50.8 x 34.9)	2.00 x 0.50 (50.8 x 12.7)	Self-Laminating TEDLAR	Yellow/White	DM	PDL-55Y	110
2.00 x 1.44 (50.8 x 36.5)	2.00 x 0.50 (50.8 x 12.7)	Self-Laminating Polyolefin	White	DM	PDL-3VF	110
2.00 x 1.44 (50.8 x 36.5)	2.00 x 0.50 (50.8 x 12.7)	Self-Laminating Vinyl	White	DM	PDL-3-1	110
2.00 x 1.44 (50.8 x 36.5)	2.00 x 0.50 (50.8 x 12.7)	Self-Laminating Vinyl	White	DM	PDL-3-10	110
2.00 x 1.44 (50.8 x 36.5)	2.00 x 0.50 (50.8 x 12.7)	Self-Laminating Vinyl	White	DM	PDL-3	110
2.00 x 1.44 (50.8 x 36.5)	2.00 x 0.50 (50.8 x 12.7)	Self-Laminating Vinyl	Blue/White	DM	PDL-3B	110
2.00 x 1.44 (50.8 x 36.5)	2.00 x 0.50 (50.8 x 12.7)	Self-Laminating Vinyl	Brown/White	DM	PDL-3BR	110
2.00 x 1.44 (50.8 x 36.5)	2.00 x 0.50 (50.8 x 12.7)	Self-Laminating Vinyl	Green/White	DM	PDL-3G	110
2.00 x 1.44 (50.8 x 36.5)	2.00 x 0.50 (50.8 x 12.7)	Self-Laminating Vinyl	Gray/White	DM	PDL-3GR	110
2.00 x 1.44 (50.8 x 36.5)	2.00 x 0.50 (50.8 x 12.7)	Self-Laminating Vinyl	Orange/White	DM	PDL-3OR	110
2.00 x 1.44 (50.8 x 36.5)	2.00 x 0.50 (50.8 x 12.7)	Self-Laminating Vinyl	Purple/White	DM	PDL-3PR	110
2.00 x 1.44 (50.8 x 36.5)	2.00 x 0.50 (50.8 x 12.7)	Self-Laminating Vinyl	Red/White	DM	PDL-3R	110
2.00 x 1.44 (50.8 x 36.5)	2.00 x 0.50 (50.8 x 12.7)	Self-Laminating Vinyl	Yellow/White	DM	PDL-3Y	110
2.00 x 1.50 (50.8 x 38.1)	2.00 x 0.50 (50.8 x 12.7)	Self-Laminating Polyester	White	L	PLL-40-Y3-1	70
2.00 x 1.50 (50.8 x 38.1)	2.00 x 0.50 (50.8 x 12.7)	Self-Laminating Vinyl	White	TT	TTSL3VC3-1	44
2.00 x 2.44 (50.8 x 61.9)	2.00 x 0.75 (50.8 x 19.1)	Self-Laminating Polyolefin	White	DM	PDL-5VF-10	110
2.00 x 2.44 (50.8 x 61.9)	2.00 x 0.75 (50.8 x 19.1)	Self-Laminating TEDLAR	White	DM	PDL-57	110
2.00 x 2.44 (50.8 x 61.9)	2.00 x 0.75 (50.8 x 19.1)	Self-Laminating TEDLAR	Blue/White	DM	PDL-57B	110
2.00 x 2.44 (50.8 x 61.9)	2.00 x 0.75 (50.8 x 19.1)	Self-Laminating TEDLAR	Brown/White	DM	PDL-57BR	110
2.00 x 2.44 (50.8 x 61.9)	2.00 x 0.75 (50.8 x 19.1)	Self-Laminating TEDLAR	Green/White	DM	PDL-57G	110

* DM = Dot-Matrix, IJ = Ink Jet, L = Laser, TT = Thermal Transfer
 ▲TEDLAR is a registered trademark of E.I. DuPont Co.

Self-Laminating Labels by Size (cont.)

Label Size Width x Length In. (mm)	Print-On Area Size Width x Length In. (mm)	Material	Print-On Area Color	Print Method*	Part Number	Page No.
2.00 x 2.44 (50.8 x 61.9)	2.00 x 0.75 (50.8 x 19.1)	Self-Laminating TEDLAR ^	Gray/White	DM	PDL-57GR	110
2.00 x 2.44 (50.8 x 61.9)	2.00 x 0.75 (50.8 x 19.1)	Self-Laminating TEDLAR	Orange/White	DM	PDL-57OR	110
2.00 x 2.44 (50.8 x 61.9)	2.00 x 0.75 (50.8 x 19.1)	Self-Laminating TEDLAR	Purple/White	DM	PDL-57PR	110
2.00 x 2.44 (50.8 x 61.9)	2.00 x 0.75 (50.8 x 19.1)	Self-Laminating TEDLAR	Red/White	DM	PDL-57R	110
2.00 x 2.44 (50.8 x 61.9)	2.00 x 0.75 (50.8 x 19.1)	Self-Laminating TEDLAR	Yellow/White	DM	PDL-57Y	110
2.00 x 2.44 (50.8 x 61.9)	2.00 x 0.75 (50.8 x 19.1)	Self-Laminating Vinyl	White	DM	PDL-5-10	110
2.00 x 2.44 (50.8 x 61.9)	2.00 x 0.75 (50.8 x 19.1)	Self-Laminating Vinyl	White	DM	PDL-5-2.5	110
2.00 x 2.44 (50.8 x 61.9)	2.00 x 0.75 (50.8 x 19.1)	Self-Laminating Vinyl	White	DM	PDL-5	110
2.00 x 2.44 (50.8 x 61.9)	2.00 x 0.75 (50.8 x 19.1)	Self-Laminating Vinyl	Blue/White	DM	PDL-5B	110
2.00 x 2.44 (50.8 x 61.9)	2.00 x 0.75 (50.8 x 19.1)	Self-Laminating Vinyl	Brown/White	DM	PDL-5BR	110
2.00 x 2.44 (50.8 x 61.9)	2.00 x 0.75 (50.8 x 19.1)	Self-Laminating Vinyl	Green/White	DM	PDL-5G	110
2.00 x 2.44 (50.8 x 61.9)	2.00 x 0.75 (50.8 x 19.1)	Self-Laminating Vinyl	Gray/White	DM	PDL-5GR	110
2.00 x 2.44 (50.8 x 61.9)	2.00 x 0.75 (50.8 x 19.1)	Self-Laminating Vinyl	Orange/White	DM	PDL-5OR	110
2.00 x 2.44 (50.8 x 61.9)	2.00 x 0.75 (50.8 x 19.1)	Self-Laminating Vinyl	Purple/White	DM	PDL-5PR	110
2.00 x 2.44 (50.8 x 61.9)	2.00 x 0.75 (50.8 x 19.1)	Self-Laminating Vinyl	Red/White	DM	PDL-5R	110
2.00 x 2.44 (50.8 x 61.9)	2.00 x 0.75 (50.8 x 19.1)	Self-Laminating Vinyl	Yellow/White	DM	PDL-5Y	110
2.00 x 3.17 (50.8 x 80.5)	2.00 x 1.00 (50.8 x 25.4)	Self-Laminating Polyester	White	L	PLL-21-Y3-1	70
2.00 x 3.87 (50.8 x 98.3)	2.00 x 1.00 (50.8 x 25.4)	Self-Laminating TEDLAR	White	DM	PDL-59-10	111
2.00 x 3.87 (50.8 x 98.3)	2.00 x 1.00 (50.8 x 25.4)	Self-Laminating TEDLAR	White	DM	PDL-59	111
2.00 x 3.87 (50.8 x 98.3)	2.00 x 1.00 (50.8 x 25.4)	Self-Laminating TEDLAR	Blue/White	DM	PDL-59B	111
2.00 x 3.87 (50.8 x 98.3)	2.00 x 1.00 (50.8 x 25.4)	Self-Laminating TEDLAR	Brown/White	DM	PDL-59BR	111
2.00 x 3.87 (50.8 x 98.3)	2.00 x 1.00 (50.8 x 25.4)	Self-Laminating TEDLAR	Green/White	DM	PDL-59G	111
2.00 x 3.87 (50.8 x 98.3)	2.00 x 1.00 (50.8 x 25.4)	Self-Laminating TEDLAR	Gray/White	DM	PDL-59GR	111
2.00 x 3.87 (50.8 x 98.3)	2.00 x 1.00 (50.8 x 25.4)	Self-Laminating TEDLAR	Orange/White	DM	PDL-59OR	111
2.00 x 3.87 (50.8 x 98.3)	2.00 x 1.00 (50.8 x 25.4)	Self-Laminating TEDLAR	Purple/White	DM	PDL-59PR	111
2.00 x 3.87 (50.8 x 98.3)	2.00 x 1.00 (50.8 x 25.4)	Self-Laminating TEDLAR	Red/White	DM	PDL-59R	111
2.00 x 3.87 (50.8 x 98.3)	2.00 x 1.00 (50.8 x 25.4)	Self-Laminating TEDLAR	Yellow/White	DM	PDL-59Y	111
2.00 x 3.94 (50.8 x 100.1)	2.00 x 1.00 (50.8 x 25.4)	Self-Laminating Polyolefin	White	DM	PDL-7VF	111
2.00 x 3.94 (50.8 x 100.1)	2.00 x 1.00 (50.8 x 25.4)	Self-Laminating Vinyl	White	DM	PDL-7-10	111
2.00 x 3.94 (50.8 x 100.1)	2.00 x 1.00 (50.8 x 25.4)	Self-Laminating Vinyl	White	DM	PDL-7-2.5	111
2.00 x 3.94 (50.8 x 100.1)	2.00 x 1.00 (50.8 x 25.4)	Self-Laminating Vinyl	White	DM	PDL-7	111
2.00 x 3.94 (50.8 x 100.1)	2.00 x 1.00 (50.8 x 25.4)	Self-Laminating Vinyl	Blue/White	DM	PDL-7B	111
2.00 x 3.94 (50.8 x 100.1)	2.00 x 1.00 (50.8 x 25.4)	Self-Laminating Vinyl	Green/White	DM	PDL-7G	111
2.00 x 3.94 (50.8 x 100.1)	2.00 x 1.00 (50.8 x 25.4)	Self-Laminating Vinyl	Red/White	DM	PDL-7R	111
2.00 x 3.94 (50.8 x 100.1)	2.00 x 1.00 (50.8 x 25.4)	Self-Laminating Vinyl	Yellow/White	DM	PDL-7Y	111
2.00 x 3.94 (50.8 x 100.1)	2.00 x 1.00 (50.8 x 25.4)	Self-Laminating Vinyl	White	TT	TTSL7VC3-1	44
2.00 x 5.94 (50.8 x 150.9)	2.00 x 1.50 (50.8 x 38.1)	Self-Laminating TEDLAR	White	DM	PDL-134	111
2.00 x 5.94 (50.8 x 150.9)	2.00 x 1.50 (50.8 x 38.1)	Self-Laminating TEDLAR	White	DM	PDL-62	111
2.00 x 5.94 (50.8 x 150.9)	2.00 x 1.50 (50.8 x 38.1)	Self-Laminating Vinyl	White	DM	PDL-133	111
2.00 x 5.94 (50.8 x 150.9)	2.00 x 1.50 (50.8 x 38.1)	Self-Laminating Vinyl	White	DM	PDL-16	111
2.00 x 5.94 (50.8 x 150.9)	2.00 x 1.50 (50.8 x 38.1)	Self-Laminating Vinyl	White	DM	PDL-16-10	111
2.00 x 5.94 (50.8 x 150.9)	2.00 x 1.50 (50.8 x 38.1)	Self-Laminating Vinyl	White	DM	PDL-16-2.5	111
2.00 x 7.44 (50.8 x 189.0)	2.00 x 1.50 (50.8 x 38.1)	Self-Laminating TEDLAR	White	DM	PDL-116	111
2.00 x 7.44 (50.8 x 189.0)	2.00 x 1.50 (50.8 x 38.1)	Self-Laminating TEDLAR	White	DM	PDL-63	111
2.00 x 7.44 (50.8 x 189.0)	2.00 x 1.50 (50.8 x 38.1)	Self-Laminating Vinyl	White	DM	PDL-115	111
2.00 x 7.44 (50.8 x 189.0)	2.00 x 1.50 (50.8 x 38.1)	Self-Laminating Vinyl	White	DM	PDL-115-2.5	111
2.00 x 7.44 (50.8 x 189.0)	2.00 x 1.50 (50.8 x 38.1)	Self-Laminating Vinyl	White	DM	PDL-17	111
2.00 x 7.44 (50.8 x 189.0)	2.00 x 1.50 (50.8 x 38.1)	Self-Laminating Vinyl	White	DM	PDL-17-2.5	111
2.00 x 9.00 (50.8 x 228.6)	2.00 x 1.50 (50.8 x 38.1)	Self-Laminating Vinyl	White	DM	PDL-362-1	111

* DM = Dot-Matrix, IJ = Ink Jet, L = Laser, TT = Thermal Transfer
 ^TEDLAR is a registered trademark of E.I DuPont Co.

PANDUIT® Wire Size Selection Guide

To use this guide, place your wire or cable in the appropriate circle to determine wire outside diameter

Diameter 0.10" (2.5mm)	
Diameter 0.20" (5.1mm)	
Diameter 0.28" (7.1mm)	
Diameter 0.54" (13.7mm)	
Diameter 0.94" (23.9mm)	
Diameter 1.40" (35.5mm)	
Diameter 1.90" (48.3 mm)	
Diameter 2.40" (61.0mm)	

The charts below indicate the approximate cable outside diameter of various electrical and communication cables.

Electrical Cables

Size	Approx. Wire Outside Diameter In. (mm)			
	TF	THW	TW	TFN / THHN / THWN
18 AWG	0.11 (2.8)	0.11 (2.8)	0.11 (2.8)	0.09 (2.3)
16 AWG	0.12 (3.0)	0.12 (3.0)	0.12 (3.0)	0.10 (2.5)
14 AWG	0.13 (3.3)	0.16 (4.1)	0.16 (4.1)	0.10 (2.5)
12 AWG	0.15 (3.8)	0.18 (4.6)	0.18 (4.6)	0.12 (3.0)
10 AWG	0.17 (4.3)	0.20 (5.1)	0.20 (5.1)	0.15 (3.8)
8 AWG	0.24 (6.1)	0.28 (7.1)	0.28 (7.1)	0.22 (5.6)
6 AWG	0.32 (8.1)	0.32 (8.1)	0.32 (8.1)	0.26 (6.6)
4 AWG	0.37 (9.4)	0.37 (9.4)	0.37 (9.4)	0.33 (8.4)
3 AWG	0.40 (10.2)	0.40 (10.2)	0.40 (10.2)	0.36 (9.1)
2 AWG	0.43 (10.9)	0.43 (10.9)	0.43 (10.9)	0.39 (9.9)
1 AWG	0.51 (12.9)	0.51 (12.9)	0.51 (12.9)	0.45 (11.4)
1/0	0.55 (14.0)	0.55 (14.0)	0.55 (14.0)	0.49 (12.4)
2/0	0.59 (15.0)	0.59 (15.0)	0.59 (15.0)	0.54 (13.7)
3/0	0.65 (16.5)	0.65 (16.5)	0.65 (16.5)	0.59 (15.0)
4/0	0.70 (17.8)	0.70 (17.8)	0.70 (17.8)	0.65 (16.5)
250 MCM	0.79 (20.1)	0.79 (20.1)	0.79 (20.1)	0.72 (18.3)
300 MCM	0.84 (21.3)	0.84 (21.3)	0.84 (21.3)	0.77 (19.6)
350 MCM	0.89 (22.6)	0.89 (22.6)	0.89 (22.6)	0.82 (20.8)
400 MCM	0.94 (23.9)	0.94 (23.9)	0.94 (23.9)	0.87 (22.1)
500 MCM	1.03 (26.2)	1.03 (26.2)	1.03 (26.2)	0.95 (24.1)
600 MCM	1.14 (29.0)	1.14 (29.0)	1.14 (29.0)	1.06 (26.9)
700 MCM	1.21 (30.7)	1.21 (30.7)	1.21 (30.7)	1.13 (28.7)
750 MCM	1.25 (31.8)	1.25 (31.8)	1.25 (31.8)	1.16 (29.5)
800 MCM	1.28 (32.5)	1.28 (32.5)	1.28 (32.5)	1.20 (30.5)
900 MCM	1.34 (34.0)	1.34 (34.0)	1.34 (34.0)	1.26 (32.0)
1000 MCM	1.40 (35.6)	1.40 (35.6)	1.40 (35.6)	1.32 (33.5)
1250 MCM	1.58 (40.1)	1.58 (40.1)	1.58 (40.1)	
1500 MCM	1.70 (43.2)	1.70 (43.2)	1.70 (43.2)	
1750 MCM	1.82 (46.2)	1.82 (46.2)	1.82 (46.2)	
2000 MCM	1.92 (48.8)	1.92 (48.8)	1.92 (48.8)	

Category 3 and Category 5 Cable

Size	Category 3	Category 5			
	Voice Grade 24 AWG UTP	Data Grade 24 AWG UTP	Data Grade 24 AWG STP	Data Grade 22 AWG UTP	Data Grade 22 AWG STP
2 Pair	0.12 (3.0)				
3 Pair	0.15 (3.8)				
4 Pair	0.19 (4.8)	0.22 (5.6)	0.25 (6.3)	0.23 (5.8)	0.29 (7.4)
25 Pair		0.42 (10.7)	0.51 (12.9)	0.54 (13.7)	0.63 (16.0)
50 Pair	0.46 (11.7)	0.66 (16.8)			
100 Pair	0.63 (16.0)	0.96 (24.4)			
300 Pair	1.07 (27.2)				

Coaxial Cable

Size	Coax
RG58/u	0.19 (4.8)
RG59/u	0.24 (6.1)
RG62A/u	0.24 (6.1)
RG6/u	0.27 (6.8)
RG11/u	0.40 (10.2)

Fiber Optic Distribution (62.5/125)

Size	Non-Plenum	Plenum
6 Strand	0.26 (6.6)	0.18 (4.6)
8 Strand	0.27 (6.9)	0.18 (4.6)
12 Strand	0.28 (7.1)	0.21 (5.3)
18 Strand	0.49 (12.4)	0.47 (11.9)
24 Strand	0.54 (13.7)	0.52 (13.2)
36 Strand	0.54 (13.7)	0.52 (13.2)
48 Strand	0.59 (15.0)	0.56 (14.2)
72 Strand	0.72 (18.3)	0.71 (18.0)

PANUIT® Alphabetical Part Number Index

Part Number	Page
BT1.5I-C through BT4I-C	154
CCS-WHT	109
CCS-YEL	109
CORD-S	8
CPPLF-5	68
CPPLF-5*	68
DS110	67
DS110-*	67
EFPL-1	100
EFPL-1*	100
EFPL10-1	100
EFPL10-1*	100
EFPT-1	69
EFPT10-1	69
HLT2I-X0 through HLT3I-X0	152
HLM-15R0	152
HSDL9*	122
HSG-***	123
HSTT-**	153
HTDU-**	155
HTU-**	155
JL2Y-10	55
JL3C-10	55
JL3Y-10	55
JL4Y-10	55
JL5Y-10	55
JL7P-10	55
JL7PO-10	55
JL7Y-10	55
JL8C-10	55
JL8P-10	55
JL8PO-10	55
JL8Y-10	55
JL9C-10	55
JL9P-10	55
JL9PO-10	55
JL9Y-10	55
JL10C-5	55
JL10P-5	55
JL10Y-5	55
JL12P-5	55
JL12Y-5	55
JL14C-10	55
JL14PO-10	55
JL14Y-10	55
JL15Y-10	55
JL16PO-2.5	55
JL16Y-5	55
JL17P-2.5	56
JL17PO-1	56
JL17PO-2.5	56
JL17Y-2.5	56
JL18PO-1	56
JL19PO-1	55
JL19Y-2.5	55
JL22PO-1	56
JL23PO-1	55
JL24PO-5	55
JL25P-SH	56
JL25Y-SH	56
JL32C-10	55
JL32Y-10	55
JL33C-5	56
JL33PO-2.5	56
JL33Y-5	56
JL35C-2.5	55
JL35P-2.5	55
JL35PO-2.5	55
JL35Y-2.5	55
JL41PO-0.5	56
JL42PO-1	56
JL111C-5	55

Part Number	Page
JL111Y-5	55
JL172P-10	55
JL172Y-10	55
JL274Y-10	55
JL287Y-10	55
JL412PO-1	56
JL900C-2.5	56
JL901C-5	55
JL901PO-5	55
JL901Y-5	55
JL902P-2.5	56
JL902Y-2.5	56
JL903P-0.5	56
JLCPL-1	55
JLEFPD-1	55
JLEFPS-1	56
JSL***	54
JT1	54
JT500	54
JT600	54
JTK	54
L3PCM**	8
L3PL3CL through WH	152
LC-1 through LC-11	10
LC-14 through LC-15	11
LC-38 through LC-41	11
LHS12W*	45
LHS12Y*	45
LHS18W*	45
LHS18Y*	45
LHS25W*	45
LHS25Y*	45
LHS50W*	45
LHS50Y*	45
LHS100W*	45
LHS100Y*	45
LHSW*	10
LHSY*	10
LL2561-***	75
LL256138-100	75
LL25615-100G	75
LL42513-100G	75
LL4252-100G	75
LL425275-250	75
LL8511-100	75
LS3-BS	8
LS3-CASE	8
LS3-RIB	7
LS3E	7
LS3EA	8
LS3EACS	7
LS3EAK-S	7
LS3EAP	7
LS3EC-S	7
LS3ECAP	7
LS3E-BP	7
LS3E-CP	8
LS3E-ES	7
LS3E-KIT	7
LS3E-MAN-A	7
LS3E-PS	7
LS4*	16
LS4H*	15
LS4M	16
LS5-D	13
LS5-HS*	14
LS5-KIT	12
LS5-1 through LS5-3	13
LS5-10 through LS5-16	14
LS5-17 through LS5-20	14
LS5-30	13
LS5-30C	14

Part Number	Page
LS5-32	13
LS5-33	13
LS5-33C	14
LS5-33T	13
LS5-34	13
LS5-35	13
LS5-35C	14
LS5-37	13
LS5-38	13
LS5-38C	14
LS5-39 through LS5-50	13
LS5-60	13
LS5-70 through LS5-90	13
LS5-530 through LS5-548	13
LS5-DC	12
LS5-DCT	13
LS5E	12
LW*	9
LWS-1 through -54	9
LWS-11P	11
MP150-C	129
MP175-C	129
MP200-C	129
MP250-C	129
MP250W175-C	129
MP350-C	129
PACM-0 through -25	138
PACM-1-33 through -67-99	138
PACM-A through -Z	140
PALM-0 through -25	138
PALM-1-10	139
PALM-1-33 through -67-99	138
PALM-A through -Z	140
PALM-A-Z	140
PALM-A1 through -A2	141
PALM-F1 through -F2	141
PALM-L1 through -L3	141
PALM-P1 through -P2	141
PALM-S1 through -S2	141
PALM-T1 through -T6	142
PALM-X1 through -X2	142
PARW125*	178
PCA07* through PCA45*	150
PCAY07* through PCAY45*	150
PCM-0 through -600	138
PCM-0-9	139
PCM-00 through -09	139
PCM-00-09	139
PCM-1-15SYM	146
PCM-1-3 through -1-18	139
PCM-1-33 through -1975-1999	138
PCM-19-36	139
PCM-110V	145
PCM-115V	145
PCM-120V	145
PCM-12V	145
PCM-1L1 through -10L3	143
PCM-1PH	144
PCM-1T1 through -7T3	143
PCM-1T1-3T3	144
PCM-220V	145
PCM-230V	145
PCM-240V	145
PCM-24V	145
PCM-277V	145
PCM-460V	145
PCM-480V	145
PCM-4T1-6T3	144
PCM-6V	145
PCM-7T1-9T3	144
PCM-A through -Z	140
PCM-A-MNS	144

PANDUIT® Alphabetical Part Number Index

Part Number	Page
PCM-A-PLS.....	144
PCM-A-PM.....	144
PCM-A-Z.....	140
PCM-A-Z-0-9.....	140
PCM-A1 through -A5.....	141
PCM-A1-A4.....	142
PCM-AC.....	144
PCM-APH.....	144
PCM-B-MNS.....	144
PCM-B-PLS.....	144
PCM-B1 through -B5.....	141
PCM-BAT.....	144
PCM-BLK through -YEL.....	142
PCM-BPH.....	144
PCM-C1 through -C5.....	141
PCM-COM.....	144
PCM-CPH.....	144
PCM-CYS.....	144
PCM-DC.....	144
PCM-E1 through -E5.....	141
PCM-F1 through -F5.....	141
PCM-F1-F4.....	142
PCM-GND.....	144
PCM-GRD.....	144
PCM-GRS.....	144
PCM-H1 through -H5.....	141
PCM-H1-H4.....	142
PCM-HOT.....	144
PCM-HRA.....	144
PCM-IGN.....	144
PCM-IN.....	144
PCM-INDA.....	144
PCM-J1 through -J4.....	141
PCM-L1 through -L5.....	141
PCM-L1-L4.....	142
PCM-LIN.....	144
PCM-LOAD.....	144
PCM-M1 through -M5.....	141
PCM-MIN.....	144
PCM-NEG.....	144
PCM-NEUT.....	144
PCM-OUT.....	144
PCM-P1 through -P4.....	141
PCM-PLM.....	144
PCM-PLS.....	144
PCM-POS.....	144
PCM-R1 through -R5.....	141
PCM-S1 through -S5.....	141
PCM-SPR.....	144
PCM-SS.....	144
PCM-T1 through -T10.....	142
PCM-T1-T4.....	142
PCM-W1-W4.....	142
PCM-X1 through -X4.....	142
PCM-X1-X4.....	142
PCM-Y1 through -Y4.....	142
PCM-Z1 through -Z3.....	142
PCM18R-TL.....	19
PCM18RY-TL.....	19
PCM20R-TL.....	19
PCM20RY-TL.....	19
PCM25R-TL.....	19
PCM25RY-TL.....	19
PCM33R-TL.....	19
PCM33RY-TL.....	19
PCM36R-TL.....	19
PCM36RY-TL.....	19
PCMB-1 through -25.....	133
PCMB-LC.....	136
PCMBR-*.....	134
PCMCP-*-*.....	145
PCT-75-Q.....	179

Part Number	Page
PCT-83-Q.....	179
PCT-91-Q.....	179
PCT-94-Q.....	179
PCT-95-Q.....	179
PCT-95F-Q.....	180
PCT-126-Q.....	176
PCT-127-Q.....	176
PCT-128-Q.....	176
PCT-141-Q.....	176
PCT-142-Q.....	176
PCT-143-Q.....	176
PCT-144-Q.....	176
PCT-168F-Q.....	180
PCT-169F-Q.....	180
PCT-170F-Q.....	180
PCT-171F-Q.....	180
PCT-172F-Q.....	180
PCT-173F-Q.....	180
PCT-174F-Q.....	180
PCT-175F-Q.....	180
PCT-178F-Q.....	180
PCT-179F-Q.....	180
PCT-180F-Q.....	180
PCT-182F-Q.....	180
PCT-183-Q.....	179
PCT-184-Q.....	179
PCT-185-Q.....	179
PCT-186-Q.....	179
PCT-187-Q.....	179
PCT-188-Q.....	179
PCT-189-Q.....	179
PCT-190-Q.....	179
PCT-191-Q.....	179
PCT-192-Q.....	179
PCT-193-Q.....	179
PCT-194-Q.....	179
PCT-195-Q.....	179
PCT-196-Q.....	179
PCT-197-Q.....	179
PCT-204-Q thru -211-Q.....	175
PCT-216-Q.....	176
PCT-217-Q.....	176
PCV***.....	157 - 158
PCWL*.....	172
PCWLL*.....	172
PCYMB-1 through -9.....	133
PDL-1.....	106
PDL-1-1.....	106
PDL-1-10.....	106
PDL-1*.....	106
PDL-1VF.....	106
PDL-2.....	108
PDL-2-1.....	108
PDL-2-10.....	108
PDL-2*.....	108
PDL-2VF.....	108
PDL-3.....	110
PDL-3-1.....	110
PDL-3-10.....	110
PDL-3*.....	110
PDL-3VF.....	110
PDL-4.....	108
PDL-4-10.....	108
PDL-4*.....	108
PDL-5.....	110
PDL-5-2.5.....	110
PDL-5-10.....	110
PDL-5*.....	110
PDL-5VF-10.....	110
PDL-6.....	109
PDL-6-2.5.....	109
PDL-6-10.....	109

Part Number	Page
PDL-6*.....	109
PDL-7.....	111
PDL-7-2.5.....	111
PDL-7-10.....	111
PDL-7*.....	111
PDL-8.....	107
PDL-8-1.....	107
PDL-8-10.....	107
PDL-8*.....	107
PDL-9.....	116
PDL-9-10.....	116
PDL-9-10T.....	116
PDL-10.....	116
PDL-10-1.....	116
PDL-11.....	116
PDL-12.....	106
PDL-13.....	113
PDL-13-1.....	113
PDL-13-10.....	113
PDL-14.....	113
PDL-14-10.....	113
PDL-15.....	113
PDL-16.....	111
PDL-16-2.5.....	111
PDL-16-10.....	111
PDL-17.....	111
PDL-17-2.5.....	111
PDL-18.....	110
PDL-18-2.5.....	110
PDL-18-10.....	110
PDL-19.....	117
PDL-19-1.....	117
PDL-19-10.....	117
PDL-20.....	117
PDL-20-1.....	117
PDL-20-10.....	117
PDL-21.....	117
PDL-21-1.....	117
PDL-21-10.....	117
PDL-22.....	117
PDL-22-1.....	117
PDL-22-10.....	117
PDL-23.....	116
PDL-23-1.....	116
PDL-23-10.....	116
PDL-24.....	118
PDL-25.....	118
PDL-25-10.....	118
PDL-26.....	118
PDL-27.....	119
PDL-27-10.....	119
PDL-28.....	119
PDL-29.....	119
PDL-29-1.....	119
PDL-29-10.....	119
PDL-30.....	116
PDL-30-1.....	116
PDL-30-10.....	116
PDL-31.....	116
PDL-31-10.....	116
PDL-32.....	119
PDL-32-1.....	119
PDL-32-10.....	119
PDL-33.....	120
PDL-34.....	114
PDL-34-1.....	114
PDL-34-10.....	114
PDL-35.....	114
PDL-35-1.....	114
PDL-35-10.....	114
PDL-36.....	114
PDL-36-10.....	114

Part Number	Page
PDL-37	115
PDL-37-1	115
PDL-37-10	115
PDL-37-50	115
PDL-38	115
PDL-38-10	115
PDL-39	115
PDL-39-10	115
PDL-40	118
PDL-40-10	118
PDL-41	118
PDL-41-1	118
PDL-41-10	118
PDL-42	106
PDL-42-10	106
PDL-43	113
PDL-43-10	113
PDL-44	113
PDL-45	113
PDL-45-1	113
PDL-45-10	113
PDL-46	113
PDL-47	113
PDL-47-10	113
PDL-48	113
PDL-48-1	113
PDL-48-10	113
PDL-49	116
PDL-49-10	116
PDL-50	116
PDL-50-10	116
PDL-51	109
PDL-52	109
PDL-52-2.5	109
PDL-53	106
PDL-53-10	106
PDL-53*	106
PDL-54	108
PDL-54*	108
PDL-55	110
PDL-55*	110
PDL-56	108
PDL-56*	108
PDL-57	110
PDL-57*	110
PDL-58	109
PDL-58*	109
PDL-59	111
PDL-59-10	111
PDL-59*	111
PDL-60	107
PDL-60*	107
PDL-61	106
PDL-62	111
PDL-63	111
PDL-64	110
PDL-65	117
PDL-66	116
PDL-67	116
PDL-68	116
PDL-69	118
PDL-70	118
PDL-71	118
PDL-72	119
PDL-73	119
PDL-73-10	119
PDL-74	116
PDL-75	116
PDL-76	119
PDL-77	119
PDL-78	119
PDL-79	120

Part Number	Page
PDL-80	120
PDL-81	120
PDL-82	114
PDL-83	114
PDL-83-10	114
PDL-84	115
PDL-85	115
PDL-86	118
PDL-87	118
PDL-87-10	118
PDL-88	106
PDL-89	113
PDL-90	113
PDL-91	113
PDL-92	116
PDL-93	116
PDL-94	116
PDL-94-1	116
PDL-94-10	116
PDL-95	109
PDL-96	109
PDL-97	117
PDL-98	117
PDL-99	117
PDL-99-10	117
PDL-100	112
PDL-101	112
PDL-102	112
PDL-103	112
PDL-104	113
PDL-105	113
PDL-106	113
PDL-106-1	113
PDL-106-10	113
PDL-107	113
PDL-108	110
PDL-109	110
PDL-109-2.5	110
PDL-110	119
PDL-110-1	119
PDL-111	119
PDL-111-1	119
PDL-112	119
PDL-113	119
PDL-114	119
PDL-115	111
PDL-115-2.5	111
PDL-116	111
PDL-117	106
PDL-118	106
PDL-118-1	106
PDL-118-10	106
PDL-119	113
PDL-120	113
PDL-120-10	113
PDL-121	113
PDL-122	113
PDL-123	109
PDL-124	109
PDL-124-2.5	109
PDL-124-10	109
PDL-125	109
PDL-126	109
PDL-126-10	109
PDL-127	118
PDL-128	118
PDL-128-10	118
PDL-129	118
PDL-130	118
PDL-131	118
PDL-132	118
PDL-132-10	118

Part Number	Page
PDL-133	111
PDL-134	111
PDL-135	114
PDL-136	114
PDL-137	114
PDL-138	114
PDL-139	120
PDL-140	120
PDL-141	120
PDL-142	120
PDL-143	120
PDL-144	120
PDL-145	119
PDL-146	119
PDL-147	119
PDL-148	119
PDL-149	119
PDL-150	119
PDL-151	120
PDL-152	120
PDL-153	120
PDL-154	120
PDL-155	120
PDL-156	120
PDL-157	117
PDL-158	117
PDL-159	121
PDL-160	121
PDL-161	121
PDL-162	121
PDL-163	120
PDL-164	120
PDL-165	120
PDL-166	120
PDL-167	115
PDL-168	106
PDL-169	106
PDL-170	115
PDL-170-10	115
PDL-171	115
PDL-172	115
PDL-172-10	115
PDL-172R	115
PDL-173	115
PDL-174	115
PDL-175	116
PDL-176	112
PDL-177	112
PDL-178	112
PDL-179	112
PDL-180	112
PDL-181	112
PDL-182	112
PDL-183	112
PDL-184	113
PDL-185	113
PDL-186	113
PDL-187	113
PDL-188	117
PDL-189	114
PDL-190	115
PDL-191	115
PDL-192	115
PDL-193	114
PDL-194	114
PDL-230	117
PDL-231	119
PDL-231-10	119
PDL-232	120
PDL-233	114
PDL-233-10	114
PDL-234	114

PANDUIT® Alphabetical Part Number Index

Part Number	Page
PDL-234-10	114
PDL-235	115
PDL-235-10	115
PDL-236	115
PDL-236-10	115
PDL-237	119
PDL-238	106
PDL-239	106
PDL-239VF	106
PDL-240	106
PDL-241	106
PDL-242	106
PDL-243	106
PDL-244	107
PDL-245	107
PDL-245-1	107
PDL-245-10	107
PDL-246	107
PDL-247	107
PDL-248	107
PDL-249	107
PDL-249-1	107
PDL-249-10	107
PDL-249VF	107
PDL-250	107
PDL-251	107
PDL-252	112
PDL-252-10	112
PDL-253	112
PDL-253-10	112
PDL-254	112
PDL-256	112
PDL-257	112
PDL-259	112
PDL-260	112
PDL-262	112
PDL-262-10	112
PDL-263	112
PDL-264	112
PDL-264-10	112
PDL-265	113
PDL-267	113
PDL-269	114
PDL-270	115
PDL-272	115
PDL-273	115
PDL-274	115
PDL-274-10	115
PDL-275	115
PDL-276	115
PDL-277	115
PDL-277-10	115
PDL-278	115
PDL-279	115
PDL-279-10	115
PDL-280	116
PDL-280-10	116
PDL-282	116
PDL-283	116
PDL-284	116
PDL-285	116
PDL-286	116
PDL-287	116
PDL-288	117
PDL-290	117
PDL-290-1	117
PDL-291	117
PDL-293	117
PDL-294	117
PDL-296	117
PDL-297	119
PDL-298	119

Part Number	Page
PDL-299	119
PDL-300	119
PDL-301	119
PDL-302	119
PDL-303	120
PDL-304	120
PDL-305	120
PDL-305-10	120
PDL-306	120
PDL-307	120
PDL-308	120
PDL-309	120
PDL-310	120
PDL-311	120
PDL-312	120
PDL-313	120
PDL-314	120
PDL-315	120
PDL-316	120
PDL-317	120
PDL-318	120
PDL-319	120
PDL-320	120
PDL-321	121
PDL-322	121
PDL-323	121
PDL-324	121
PDL-325	121
PDL-326	121
PDL-327	121
PDL-328	121
PDL-329	121
PDL-330	121
PDL-331	121
PDL-332	121
PDL-333	121
PDL-334	121
PDL-335	121
PDL-336	121
PDL-337	121
PDL-338	121
PDL-339	121
PDL-340	121
PDL-341	121
PDL-342	121
PDL-343	121
PDL-344	121
PDL-345	121
PDL-346	121
PDL-347	112
PDL-349	112
PDL-351	112
PDL-353	112
PDL-355	112
PDL-357	118
PDL-358	118
PDL-359-10	118
PDL-360-10	118
PDL-361-1	109
PDL-362-1	111
PDL-363	117
PDL-370	118
PDL-400	114
PDL-401	114
PDL-401-10	114
PDL-401-D	114
PDL-402-10	114
PDL-402-D	114
PDL-403-1	121
PDL-403-2.5	121
PDL-403-1*	121
PDL-404-1	121

Part Number	Page
PDL-404-2.5	121
PDL-405-10	114
PDL-405-D	114
PDL-406-10	114
PDL-406-D	114
PDL-407-1	118
PDL-408-TL	119
PDL-409-1	118
PDL-410-TL	120
PDL-411-1	99
PDL-411-1*	99
PDL-412	99
PDL-500	90
PDL-629	118
PDL-3523-1	109
PDL-4565-1	116
PDL-4565-2	117
PDL-4674-1	117
PDL-4674-3	117
PDL-5712-2	118
PDL-5859-1	109
PDL-5859-2	107
PDL-5859-3	109
PDL-5859-4	107
PDL-6556-2	106
PDL-6626-10	109
PDL-7294-1	117
PDL-7517	119
PDL-7542-10	118
PDL-7557-1	120
PDL-7572-10R	119
PDL-7572-1R	119
PDL-7966-10	112
PDL-9025-10	108
PDL-PROG-LT	29
PDL110G5	119
PDLR*	127-128
PDOT25*	178
PDP*	125
PECWMS*	101
PEDL*	101
PEIP-A*	177
PEIP-C*	177
PEIP-D*	177
PEL-1-Y1-10	76
PEL-1-Y2-10	76
PEL-2-Y1-10	76
PEL-2-Y2-10	76
PEL-2-Y2Y-10	76
PEL-2-Y3M-10	76
PEL-3-Y1-5	77
PEL-3-Y1C-5	77
PEL-3-Y2-5	77
PEL-4-Y1-10	76
PEL-4-Y1C-10	76
PEL-4-Y2-10	76
PEL-4-Y2Y-10	76
PEL-5-Y1-10	76
PEL-5-Y2-10	76
PEL-5-Y2Y-10	76
PEL-6-Y1-5	76
PEL-6-Y1C-5	76
PEL-6-Y2-5	76
PEL-7-Y1-5	77
PEL-7-Y2-5	77
PEL-7-Y2Y-5	77
PEL-7-Y3M-5	77
PEL-8-Y1-2.5	77
PEL-8-Y1C-2.5	77
PEL-8-Y2-2.5	77
PEL-9-Y1-10	76
PEL-9-Y1C-10	76

Part Number	Page
PEL-9-Y2-10	76
PEL-10-Y1-5	76
PEL-10-Y2-5	76
PEL-10-Y2Y-5	76
PEL-10-Y3M-5	76
PEL-11-Y1-5	76
PEL-11-Y1C-5	76
PEL-11-Y2-5	76
PEL-11-Y2Y-5	76
PEL-12-Y1-2.5	77
PEL-12-Y2-2.5	77
PEL-12-Y2Y-2.5	77
PEL-13-Y1-2.5	77
PEL-13-Y2-2.5	77
PEL-14-Y1-1	77
PEL-14-Y2-1	77
PEL-15-Y1-1	77
PEL-15-Y1C-1	77
PEL-15-Y2-1	77
PEL-15-Y2Y-1	77
PEL-16-Y1-0.5	77
PEL-16-Y1C-0.5	77
PEL-16-Y2-0.5	77
PEL-17-***-2.5	71
PEL-17-Y3-2.5	71
PEL-18-***-1	71
PEL-18-Y3-1	71
PEL-19-***-1	71
PEL-19-Y3-1	71
PEL-20-Y3-1	71
PEL-21-***-0.5	71
PEL-21-Y3-0.5	71
PEL-22-Y3-0.5	71
PEL-23-Y3-0.5	71
PEL-24-Y2Y-10	76
PEL-25-Y2Y-10	76
PEL-26-Y2Y-5	76
PEL-27-Y2Y-5	76
PEL-28-Y2-5	76
PEL-28-Y3M-5	76
PEL-29-Y2-10	76
PEL-29-Y3M-10	76
PEL-A4-Y1-25	77
PEL-A4-Y1C-25	77
PEL-A4-Y2-25	77
PEL-A4-Y2Y-25	77
PEL-A4-Y3-25	77
PEL-A4-Y3M-25	77
PES-L*Q	176
PESC-A-***V	159
PESC-B-***V	159
PESC-C-***V	159
PESC-D-***V	159
PESC-F-***	159
PESC-H-**	160
PESC-J-**	160
PESG-A-1	167
PESG-B-1	167
PESG-C-1	167
PESG-D-1	167
PESS-A-AQ	147
PESS-A-CE	147
PESS-A-CECC	177
PESS-A-E	147
PESS-A-ES	147
PESS-A-EX1	147
PESS-A-EX2	147
PESS-A-FS	147
PESS-A-GS1	177
PESS-A-GS2	177
PESS-A-L+	147
PESS-A-L-	147

Part Number	Page
PESS-A-L1	147
PESS-A-L2	147
PESS-A-L3	147
PESS-A-M	147
PESS-A-MM	147
PESS-A-N	147
PESS-A-NS	147
PESS-A-PE	147
PESS-A-PEN	147
PESS-A-PS	147
PESS-A-PU	147
PESS-A-SCH	147
PESS-A-SG	147
PESS-A-SS	147
PESS-A-SU	147
PESS-A-TE	147
PESS-A-VDE1	177
PESS-A-VDE2	177
PESS-A-VDE3	177
PESS-B-AQ	147
PESS-B-CE	147
PESS-B-CECC	177
PESS-B-E	147
PESS-B-ES	147
PESS-B-EX1	147
PESS-B-EX2	147
PESS-B-FS	147
PESS-B-GS1	177
PESS-B-GS2	177
PESS-B-L+	147
PESS-B-L-	147
PESS-B-L1	147
PESS-B-L2	147
PESS-B-L3	147
PESS-B-M	147
PESS-B-MM	147
PESS-B-N	147
PESS-B-NS	147
PESS-B-PE	147
PESS-B-PEN	147
PESS-B-PS	147
PESS-B-PU	147
PESS-B-SCH	147
PESS-B-SG	147
PESS-B-SS	147
PESS-B-SU	147
PESS-B-TE	147
PESS-B-VDE1	177
PESS-B-VDE2	177
PESS-B-VDE3	177
PESS-C-AQ	147
PESS-C-CE	147
PESS-C-CECC	177
PESS-C-E	147
PESS-C-ES	147
PESS-C-EX1	147
PESS-C-EX2	147
PESS-C-FS	147
PESS-C-GS1	177
PESS-C-GS2	177
PESS-C-L+	147
PESS-C-L-	147
PESS-C-L1	147
PESS-C-L2	147
PESS-C-L3	147
PESS-C-M	147
PESS-C-MM	147
PESS-C-N	147
PESS-C-NS	147
PESS-C-PE	147
PESS-C-PEN	147
PESS-C-PS	147

Part Number	Page
PESS-C-PU	147
PESS-C-SCH	147
PESS-C-SG	147
PESS-C-SS	147
PESS-C-SU	147
PESS-C-TE	147
PESS-C-VDE1	177
PESS-C-VDE2	177
PESS-C-VDE3	177
PESS-D-AQ	147
PESS-D-CE	147
PESS-D-CECC	177
PESS-D-E	147
PESS-D-ES	147
PESS-D-EX1	147
PESS-D-EX2	147
PESS-D-FS	147
PESS-D-GS1	177
PESS-D-GS2	177
PESS-D-L+	147
PESS-D-L-	147
PESS-D-L1	147
PESS-D-L2	147
PESS-D-L3	147
PESS-D-M	147
PESS-D-MM	147
PESS-D-N	147
PESS-D-NS	147
PESS-D-PE	147
PESS-D-PEN	147
PESS-D-PS	147
PESS-D-PU	147
PESS-D-SCH	147
PESS-D-SG	147
PESS-D-SS	147
PESS-D-SU	147
PESS-D-TE	147
PESS-D-VDE1	177
PESS-D-VDE2	177
PESS-D-VDE3	177
PESS-E-AQ	147
PESS-E-CE	147
PESS-E-CECC	177
PESS-E-E	147
PESS-E-ES	147
PESS-E-EX1	147
PESS-E-EX2	147
PESS-E-FS	147
PESS-E-GS1	177
PESS-E-GS2	177
PESS-E-L+	147
PESS-E-L-	147
PESS-E-L1	147
PESS-E-L2	147
PESS-E-L3	147
PESS-E-M	147
PESS-E-MM	147
PESS-E-N	147
PESS-E-NS	147
PESS-E-PE	147
PESS-E-PEN	147
PESS-E-PS	147
PESS-E-PU	147
PESS-E-SCH	147
PESS-E-SG	147
PESS-E-SS	147
PESS-E-SU	147
PESS-E-TE	147
PESS-E-VDE1	177
PESS-E-VDE2	177
PESS-E-VDE3	177
PESS-SEL	76

PANDUIT® Alphabetical Part Number Index

Part Number	Page
PESV-C*	167
PESV-D*	167
PESV-E*	167
PESW-A*	166
PESW-B*	166
PESW-C*	166
PESW-D*	166
PESW-E*	166
PESWMS**	102
PFX-0	101
PFX-2	101
PJIBM*	137
PL115-12	105
PL130315-2	105
PL130315-2P	105
PL2515-1	103
PL2515-2	103
PL2515-3	103
PL2515-4	103
PL2515-5	103
PL275115-1	103
PL27515-1	103
PL27515-3	103
PL27515-4	103
PL27517-1	103
PL2757-1	103
PL2757-4	103
PL2915-4	103
PL2M2S-L	129
PL315-1	103
PL315-4	103
PL3215-4	103
PL3278-4	104
PL329-4	104
PL3315-4	103
PL3510-1F	104
PL3510-1F*	104
PL35115-1	103
PL35115-3	103
PL3515-1	103
PL3515-1R	105
PL3515-1TB	104
PL3515-1TG	104
PL3515-1TP	104
PL3515-1TRL	105
PL3515-1TT	104
PL3515-1TY	104
PL3515-2	103
PL3515-3	103
PL3515-3R	105
PL3515-4	103
PL3517-1	103
PL3517-3	103
PL3517-1TRL	105
PL357-1	103
PL357-2	103
PL357-3	103
PL3817-1TRL	105
PL38175-1TRL	105
PL3M2S-L	129
PL4115-1	103
PL4115-3	103
PL415-1	103
PL415-2	103
PL415-3	103
PL417-1	103
PL417-1R	105
PL417-1TB	104
PL417-1TG	104
PL417-1TP	104
PL417-1TRL	105
PL417-1TT	104

Part Number	Page
PL417-1TY	104
PL417-2	103
PL417-3	103
PL4175-1TRL	105
PL4215-1	103
PL4215-3	103
PL425215-1	103
PL427-1	103
PL47-1	103
PL5115-1	103
PL515-1	103
PL515-2	103
PL517-1	103
PL5215-1	103
PL5215-2	103
PL5315-1	103
PL5315-2	103
PL57-1	103
PL575215-1	103
PL6315-1	105
PL6315-2	105
PL65315-2	105
PL77515-1	103
PL7757-1	103
PLD-1	148
PLD-2	148
PLD-3	173
PLD-4	173
PLD-5	173
PLD-6	173
PLD-7	173
PLD-8	173
PLD-11	173
PLD-12	163
PLD-16	173
PLD-17	173
PLD-18	173
PLD-20	173
PLD-21	173
PLD-22	173
PLD-26	173
PLD-29	173
PLD-30	173
PLD-31	173
PLD-32	163
PLD-33	162
PLD-36	163
PLD-37	163
PLD-38	163
PLD-39	163
PLD-40	163
PLD-42	173
PLD-43	163
PLD-44	163
PLD-45	163
PLD-46	163
PLD-47	163
PLD-48	163
PLD-49	162
PLD-52	163
PLD-53	164
PLD-54	164
PLD-55	173
PLD-56	164
PLD-57	164
PLD-58	162
PLD-59	162
PLD-60	162
PLD-62	178
PLD-63	178
PLD-64	178
PLD-65	178

Part Number	Page
PLD-67	164
PLD-69	164
PLD-70	164
PLD-71	164
PLD-73	164
PLD-74	164
PLD-75	164
PLD-76	163
PLD-77	178
PLD-78	178
PLD-79	164
PLD-80	164
PLD-81	164
PLD-82	163
PLD-83	165
PLD-84	165
PLD-85	165
PLD-86	165
PLDR-1	148
PLDR-2	148
PLF1M-C	129
PLF1MA-C	129
PLF1MB-C	129
PLL-1-Y2-10	75
PLL-1-Y2Y-10	75
PLL-2-Y2-10	72
PLL-2-Y2Y-10	72
PLL-3-Y3-5	70
PLL-4-Y2-10	72
PLL-4-Y2Y-10	72
PLL-5-Y2-10	72
PLL-5-Y2Y-10	72
PLL-6-Y2-5	72
PLL-6-Y2-10	72
PLL-6-Y2Y-5	72
PLL-6-Y2Y-10	72
PLL-7-Y2-10	72
PLL-7-Y2Y-10	72
PLL-8-PO-10	72
PLL-8-Y2-5	72
PLL-8-Y2-10	72
PLL-8-Y2Y-5	72
PLL-8-Y2Y-10	72
PLL-9-POR-10	73
PLL-9-Y2-5	73
PLL-9-Y2-10	73
PLL-9-Y2S-10	73
PLL-9-Y2Y-5	73
PLL-9-Y2Y-10	73
PLL-9-Y3C-5	73
PLL-10-Y3-5	70
PLL-10-PO-5	73
PLL-10-Y3-2.5	70
PLL-10-Y3-5	70
PLL-10-Y3C-2.5	73
PLL-11-Y2-2.5	73
PLL-11-Y3-2.5	70
PLL-11-Y3*-2.5	70
PLL-11-Y3C-2.5	73
PLL-12-Y2-1	73
PLL-12-Y2-2.5	73
PLL-12-Y3-1	70
PLL-12-Y3-2.5	70
PLL-12-Y3*-2.5	70
PLL-13-Y3-1	70
PLL-13-Y3-D	70
PLL-14-PO-5	73
PLL-14-POR-5	73
PLL-14-Y2-5	73
PLL-14-Y2-10	73
PLL-14-Y2Y-5	73
PLL-15-Y2-5	73

Part Number	Page
PLL-15-Y2-10.....	73
PLL-15-Y2Y5.....	73
PLL-16-PO-2.5.....	73
PLL-16-Y2-2.5.....	73
PLL-16-Y2-5.....	73
PLL-16-Y2Y2.5.....	73
PLL-16-Y2Y5.....	73
PLL-17-PO-2.5.....	73
PLL-17-Y2-1.....	73
PLL-17-Y2-2.5.....	73
PLL-17-Y2Y2.5.....	73
PLL-18-Y2-1.....	74
PLL-18-Y2-1.5.....	74
PLL-18-Y2Y1.....	74
PLL-18-Y2Y1.5.....	74
PLL-19-POR-2.5.....	74
PLL-19-Y2-1.....	74
PLL-19-Y2-2.5.....	74
PLL-19-Y2Y1.....	74
PLL-19-Y2Y2.5.....	74
PLL-20-Y2-10.....	72
PLL-20-Y2Y10.....	72
PLL-21-Y3-1.....	70
PLL-22-PO-1.....	74
PLL-22-PO-1*.....	74
PLL-22-Y2-1.....	74
PLL-22-Y3-1.....	74
PLL-23-Y2-1.....	72
PLL-23-Y2-5.....	72
PLL-23-Y3-1.....	72
PLL-23-Y3-5.....	72
PLL-24-Y2-1.....	72
PLL-24-Y2-5.....	72
PLL-24-Y3-1.....	72
PLL-24-Y3-5.....	72
PLL-25-PO-SH.....	74
PLL-25-POR-SH.....	74
PLL-25-Y2-SH.....	74
PLL-25-Y2S-SH.....	74
PLL-25-Y2Y-SH.....	74
PLL-25-Y3C-SH.....	74
PLL-26-Y2-1.....	74
PLL-27-Y2-1.....	74
PLL-28-Y2-1.....	74
PLL-29-Y2-1.....	74
PLL-30-Y2-10.....	75
PLL-31-POR-10.....	72
PLL-31-Y2-10.....	72
PLL-32-Y2-10.....	72
PLL-32-Y2Y10.....	72
PLL-33-PO-5.....	72
PLL-33-Y3-5.....	70
PLL-34-POR-10.....	73
PLL-34-Y2-10.....	73
PLL-34-Y2Y10.....	73
PLL-35-PO-2.5.....	73
PLL-35-POR-2.5.....	73
PLL-35-Y2S-2.5.....	73
PLL-36-PO-1.....	74
PLL-36-POR-1.....	74
PLL-36-Y2-1.....	74
PLL-36-Y2S-1.....	74
PLL-37-Y3-1.....	70
PLL-38-Y3-1.....	70
PLL-39-Y3-1.....	70
PLL-40-Y3-1.....	70
PLM1M-C.....	129
PLM2M-C.....	129
PLM2S-C.....	129
PLM4S-C.....	129
PLMA1 through PLMA16.....	135
PLT1.5I-C through PLT4I-C.....	154

Part Number	Page
PLT2S-C through PLT5S-C.....	152
PM-*.....	146
PMD.....	148
PMD-0-9.....	148
PMD-NEMA.....	148
PMDR-*.....	148
PPM-0 through -49.....	138
PPM-0-9.....	139
PPM-1-33 through -675-699.....	138
PPM-1-12.....	139
PPM-1-18.....	139
PPM-1-6.....	139
PPM-220V.....	145
PPM-A through -Z.....	140
PPM-A-Z.....	140
PPM-A1 through -A2.....	141
PPM-AC.....	144
PPM-BLK through -YEL.....	142
PPM-C1 through -C2.....	141
PPM-DC.....	144
PPM-F1 through -F3.....	141
PPM-GND.....	144
PPM-H1 through -H4.....	141
PPM-L1 through -L3.....	141
PPM-MIN.....	144
PPM-P1 through -P2.....	141
PPM-PLS.....	144
PPM-S1 through -S4.....	141
PPM-T1 through -T4.....	142
PPM-X1 through -X4.....	142
PPMCP-*.....	145
PPS0710****.....	31
PPS1014****.....	31
PPS1420****.....	31
PROG-LITE.....	30
PROG-WIN2.....	28
PROG-WIN2CD.....	28
PRS0710****.....	31
PRS1014****.....	31
PRS1420****.....	31
PSCB-3.....	136
PSCB-3CAL.....	171
PSCB-3***.....	136
PSCB-5.....	136
PSCB-6.....	136
PSCB-6CAL.....	171
PSCB-6***.....	136
PSCB-12.....	136
PSCB-13.....	136
PSCB-16.....	136
PSCB-BLNK.....	137
PSCB-COM.....	137
PSCB-COMS.....	137
PSCB-D.....	137
PSCB-DS.....	137
PSCB-LAN.....	137
PSCB-V.....	137
PSCB-VS.....	137
PSCBF-***.....	137
PSCC-3.....	146
PSCC-5.....	146
PSM-0 through -200.....	138
PSM-0-9.....	139
PSM-00 through -09.....	139
PSM-1-33 through -67-99.....	138
PSM-1L1 through -4L4.....	143
PSM-1T1 through -4T3.....	143
PSM-A through -Z.....	140
PSM-A-Z.....	140
PSM-A-Z-0-9.....	140
PSM-A1 through -A3.....	141
PSM-D1 through -D5.....	141

Part Number	Page
PSM-L1 through -L3.....	141
PSM-SPARE.....	144
PSM-T1 through -T3.....	142
PSM-X1 through -X2.....	142
PST-4 thru -7.....	32
PST-FO.....	154
PST-FOBLNK.....	154
PSWBF-***.....	137
PSWM-***.....	146
PSWMH-***.....	146
PSWMS-****.....	102
PT-***.....	154
PTR-CLN.....	8
PTR1.....	17
PTR1-AC.....	17
PTR1-AC220.....	17
PTR1-RIB.....	17
PTR1-MAN.....	17
PTR1-STD.....	17
PTR2.....	20
PTR2-RS.....	20
PTR3.....	26
PX-0.....	101
PX-2.....	101
QL-1***.....	171
QL-2 through -20.....	170
QL-21***.....	171
QLF-***.....	174
SEZ-ELECKIT1.....	31
SEZ-PIPEKIT1.....	31
SEZ-PM.....	31
SEZ-PMC**.....	32
SEZ-TAG**.....	32
SLCT-*.....	152
SM02W-*.....	149
SM1W-*.....	149
SM2W-*.....	149
SM3W-*.....	149
SM4W-*.....	149
SMB02W-*.....	149
SMB1W-*.....	149
SMB2W-*.....	149
SMB3W-*.....	149
SMB4W-*.....	149
TTC-CPL-1.....	40
TTC-DS110-5.....	40
TTC-EFPL-1.....	41
TTC-EFPLC-1.....	41
TTC-EFPL10-1.....	41
TTC-MJ-5.....	41
TTC-MJWH-5.....	41
TTC1Y-10.....	42
TTC2Y-10.....	42
TTC3Y-10.....	42
TTC3YS-10.....	42
TTC3YST-10.....	42
TTC4T-10.....	42
TTC4Y-10.....	42
TTC4YST-10.....	42
TTC5T-10.....	42
TTC5Y-10.....	42
TTC5YS-10.....	42
TTC5YST-10.....	42
TTC6T-10.....	42
TTC6Y-10.....	42
TTC7Y-10.....	42
TTC7YS-10.....	42
TTC8ET-10.....	42
TTC8T-10.....	42
TTC8Y-10.....	42
TTC8YC-10.....	42
TTC8YS-10.....	42

PANDUIT® Alphabetical Part Number Index

Part Number	Page
TTC8YST-10.....	42
TTC9Y-10.....	42
TTC10T-10.....	42
TTC10Y-10.....	42
TTC11Y-10.....	42
TTC12Y-10.....	42
TTC13Y-10.....	42
TTC13YS-10.....	42
TTC14Y-2.5.....	42
TTC15P-2.5.....	42
TTC15Y-2.5.....	42
TTC16Y-2.5.....	42
TTC17Y-2.5.....	42
TTC18Y-2.5.....	42
TTC19Y-2.5.....	42
TTC20P-2.5.....	42
TTC20Y-2.5.....	42
TTC20YC-2.5.....	42
TTC20YS-2.5.....	42
TTC20YST-2.5.....	42
TTC21P-2.5.....	42
TTC22P-2.5.....	43
TTC22Y-2.5.....	43
TTC22YS-2.5.....	43
TTC23Y-2.5.....	43
TTC24P-2.5.....	43
TTC24Y-2.5.....	43
TTC24YC-2.5.....	43
TTC24YS-2.5.....	43
TTC24YST-2.5.....	43
TTC25P-1.....	43
TTC25Y-1.....	43
TTC25YC-1.....	43
TTC25YS-1.....	43
TTC25YST-1.....	43
TTC26P-1.....	43
TTC27Y-10.....	43
TTC28Y-10.....	43
TTC29Y-5.....	43
TTC30Y-2.5.....	43
TTC31P-1.....	43
TTC31Y-1.....	43
TTC32P-1.....	43
TTC32Y-1.....	43
TTC33P-5.....	43
TTC34P-5.....	43
TTC35P-2.5.....	43
TTC35Y-2.5.....	43
TTC36P-1.....	43
TTC36Y-1.....	43
TTC36YS-1.....	43
TTC37P-1.....	43
TTC37Y-1.....	43
TTC38P-1.....	43
TTC38Y-1.....	43
TTC39P-1.....	43
TTC39Y-1.....	43
TTC40P-1.....	43
TTC41P-1.....	43
TTC41Y-1.....	43
TTC42P-5.....	43
TTC42Y-5.....	43
TTC43P-1.....	44
TTC43Y-1.....	44
TTC44P-1.....	44
TTC44Y-1.....	44
TTC45Y-1.....	42
TTC46P-5.....	43
TTP2-***.....	21
TTP4-***.....	21
TTPA2-WHT.....	21
TTPA4-WHT.....	21

Part Number	Page
TTR-BL.....	46
TTR-WH.....	46
TTR2-BL.....	46
TTR2-WH.....	46
TTR4-BL-S.....	46
TTR4-BL-Z.....	46
TTR4W-BL-S.....	46
TTR4W-BL-Z.....	46
TTR6-BL-S.....	46
TTR6-BL-Z.....	46
TTR6W-BL-S.....	46
TTR6W-BL-Z.....	46
TTRW-BL.....	46
TTRW2-BL.....	46
TTSL-*.....	22
TTSL1VC3-10.....	44
TTSL2VC3-10.....	44
TTSL3VC3-1.....	44
TTSL4VC3-5.....	44
TTSL6V3-2.5.....	44
TTSL7VC3-1.....	44
TTSL8VC3-10.....	44
TTSL9VC3-10.....	44
TTSL10VC3-5.....	44
TTSL247VC3-10.....	44
TTSL250VC3-10.....	44
TTV2-***.....	21
TTV4-***.....	21
WL1.....	162
WL3.....	162
WL25.....	163
WL32.....	163
WL33.....	163
WL35.....	165
WL36.....	165

Компания «Life Electronics» занимается поставками электронных компонентов импортного и отечественного производства от производителей и со складов крупных дистрибьюторов Европы, Америки и Азии.

С конца 2013 года компания активно расширяет линейку поставок компонентов по направлению коаксиальный кабель, кварцевые генераторы и конденсаторы (керамические, пленочные, электролитические), за счёт заключения дистрибьюторских договоров

Мы предлагаем:

- Конкурентоспособные цены и скидки постоянным клиентам.
- Специальные условия для постоянных клиентов.
- Подбор аналогов.
- Поставку компонентов в любых объемах, удовлетворяющих вашим потребностям.
- Приемлемые сроки поставки, возможна ускоренная поставка.
- Доставку товара в любую точку России и стран СНГ.
- Комплексную поставку.
- Работу по проектам и поставку образцов.
- Формирование склада под заказчика.
- Сертификаты соответствия на поставляемую продукцию (по желанию клиента).
- Тестирование поставляемой продукции.
- Поставку компонентов, требующих военную и космическую приемку.
- Входной контроль качества.
- Наличие сертификата ISO.

В составе нашей компании организован Конструкторский отдел, призванный помогать разработчикам, и инженерам.

Конструкторский отдел помогает осуществить:

- Регистрацию проекта у производителя компонентов.
- Техническую поддержку проекта.
- Защиту от снятия компонента с производства.
- Оценку стоимости проекта по компонентам.
- Изготовление тестовой платы монтаж и пусконаладочные работы.



Тел: +7 (812) 336 43 04 (многоканальный)

Email: org@lifeelectronics.ru