



Typical Applications

Low noise MMIC VCO w/Divide-by-16 for:

- VSAT Radio
- Point to Point/Multipoint Radio
- Test Equipment & Industrial Controls
- Military End-Use
- Automotive Radar

Features

- Pout: +12 dBm
- Phase Noise: -95 dBc/Hz @100 KHz Typ.
- No External Resonator Needed
- Single Supply: +5V @ 220 mA
- 24 Lead 4x4mm QFN Package: 9 mm²

Functional Diagram

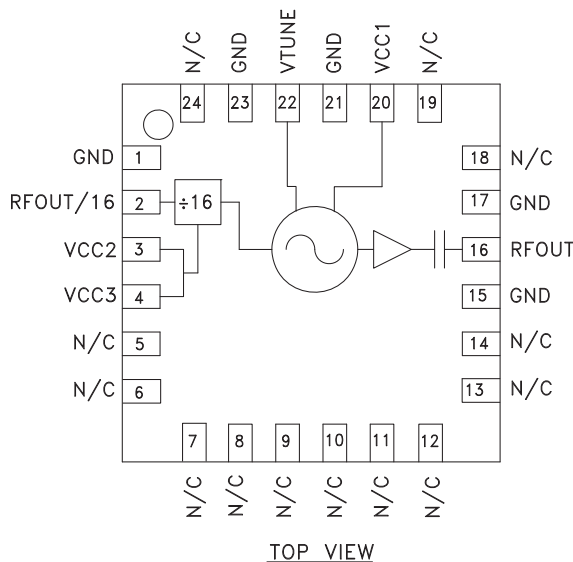

General Description

The HMC533LP4 & HMC533LP4E are GaAs InGaP Heterojunction Bipolar Transistor (HBT) MMIC VCOs. The HMC533LP4 & HMC533LP4E integrate resonators, negative resistance devices, varactor diodes and feature a divide-by-16 output. The VCO's phase noise performance is excellent over temperature, shock, and process due to the oscillator's monolithic structure. Power output is +12 dBm typical from a +5V supply voltage. Prescaler function can be disabled to conserve current if not required. The voltage controlled oscillator is packaged in a leadless QFN 4 x 4 mm surface mount package.

Electrical Specifications, $T_A = +25^\circ C$, V_{cc1} , V_{cc2} , $V_{cc3} = +5V$

Parameter	Min.	Typ.	Max.	Units	
Frequency Range	23.8 - 24.8			GHz	
Power Output	RFOUT +9	+12	+15	dBm	
	RFOUT/16 -7	-4	-1	dBm	
SSB Phase Noise @ 100 kHz Offset, $V_{tune} = +5V$ @ RFOUT		-95		dBc/Hz	
Tune Voltage	V_{tune}	2	13	V	
Supply Current	I_{cc}	180	220	260	mA
Tune Port Leakage Current ($V_{tune} = 13V$)			10	μA	
Output Return Loss		3		dB	
Harmonics/Subharmonics	1/2	26		dBc	
	3/2	37		dBc	
Pulling (into a 2.0:1 VSWR)		13		MHz/pp	
Pushing @ $V_{tune} = 5V$		80		MHz/V	
Frequency Drift Rate		2.3		MHz/ $^\circ C$	

Information furnished by Analog Devices is believed to be accurate and reliable. However, no responsibility is assumed by Analog Devices for its use, nor for any infringements of patents or other rights of third parties that may result from its use. Specifications subject to change without notice. No license is granted by implication or otherwise under any patent or patent rights of Analog Devices. Trademarks and registered trademarks are the property of their respective owners.

For price, delivery, and to place orders: Analog Devices, Inc., One Technology Way, P.O. Box 9106, Norwood, MA 02062-9106
Phone: 781-329-4700 • Order online at www.analog.com
Application Support: Phone: 1-800-ANALOG-D



Frequency vs. Tuning Voltage, T= 25°C

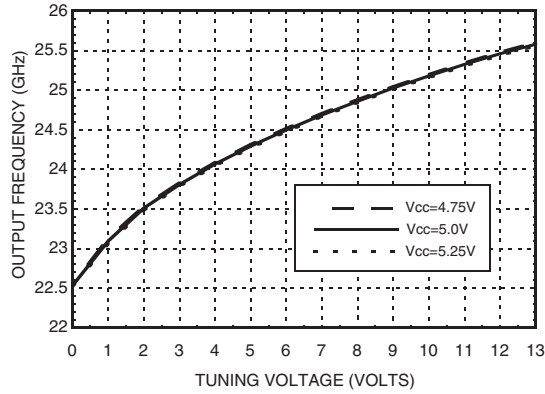

Frequency vs. Tuning Voltage, Vcc= +5V

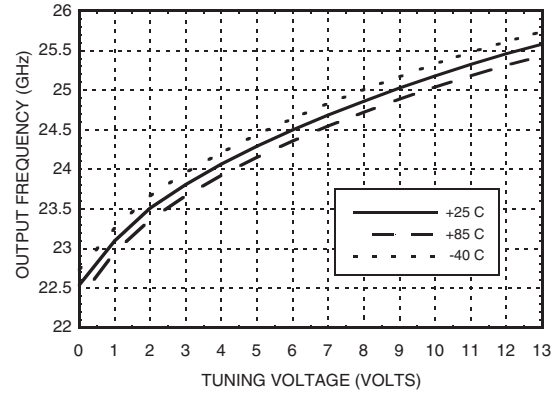

Sensitivity vs. Tuning Voltage, Vcc= +5V

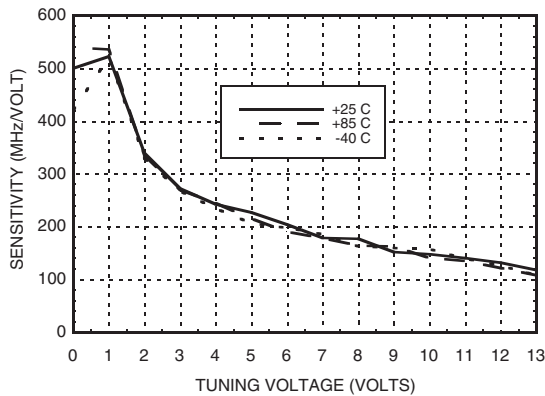

Output Power vs. Tuning Voltage, Vcc= +5V

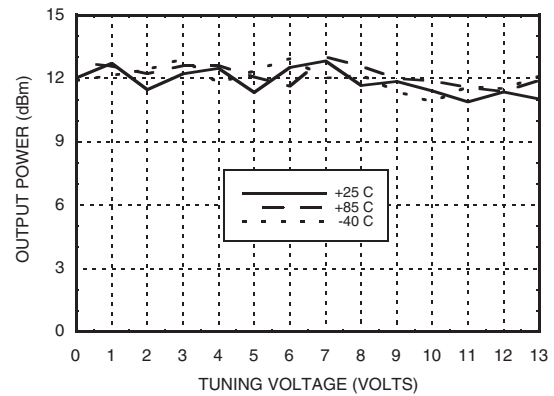

Information furnished by Analog Devices is believed to be accurate and reliable. However, no responsibility is assumed by Analog Devices for its use, nor for any infringements of patents or other rights of third parties that may result from its use. Specifications subject to change without notice. No license is granted by implication or otherwise under any patent or patent rights of Analog Devices. Trademarks and registered trademarks are the property of their respective owners.

For price, delivery, and to place orders: Analog Devices, Inc., One Technology Way, P.O. Box 9106, Norwood, MA 02062-9106 Phone: 781-329-4700 • Order online at www.analog.com Application Support: Phone: 1-800-ANALOG-D



SSB Phase Noise vs. Tuning Voltage

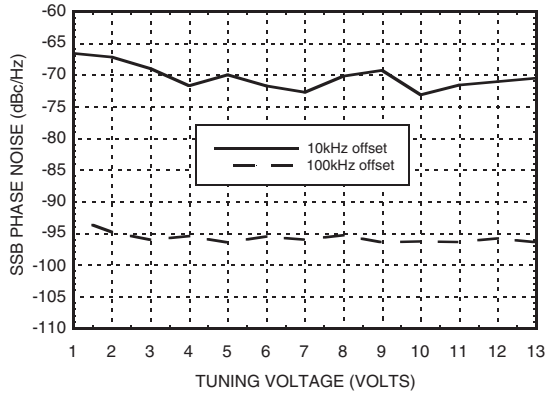

SSB Phase Noise @ $V_{tune} = +5V$

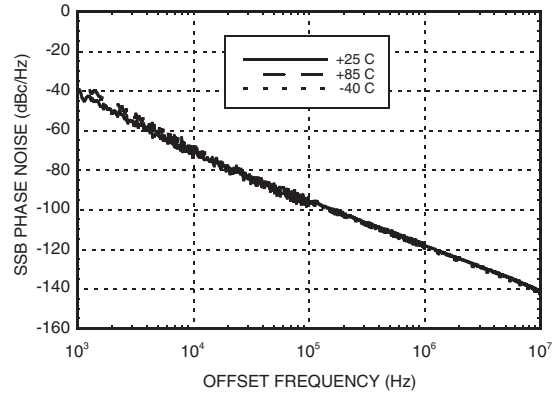

Divide-by-16 Frequency vs. Tuning Voltage, $V_{cc} = +5V$

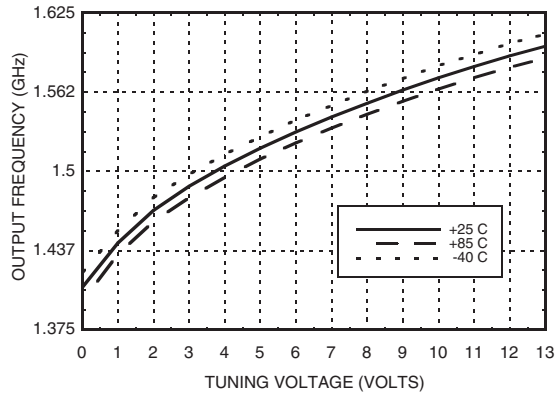

Divide-by-16 Output Power vs. Tuning Voltage, $V_{cc} = +5V$

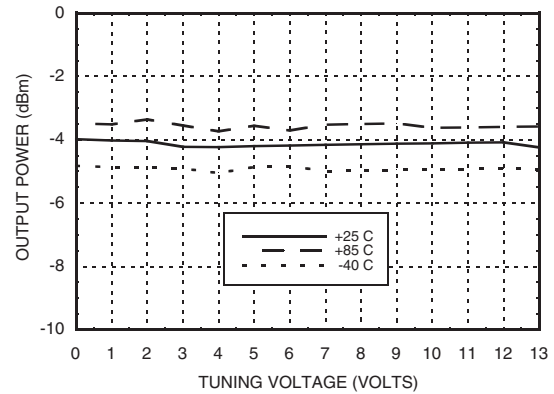

Absolute Maximum Ratings

Vcc1, Vcc2	5.5 V
Vtune	0 to 15V Max.
Junction Temperature	135 °C
Continuous P _{diss} (T=85 °C) (derate 28 mW/C above 85 °C)	1.4 W
Thermal Resistance	36 °C/W
Storage Temperature	-65 to +150 °C
Operating Temperature	-40 to +85 °C
ESD Sensitivity (HBM)	Class 1A

Typical Supply Current vs. Vcc

Vcc (V)	I _{cc} (mA)
4.75	200
5.0	220
5.25	240

Note: VCO will operate over full voltage range shown above.



ELECTROSTATIC SENSITIVE DEVICE
OBSERVE HANDLING PRECAUTIONS



Outline Drawing

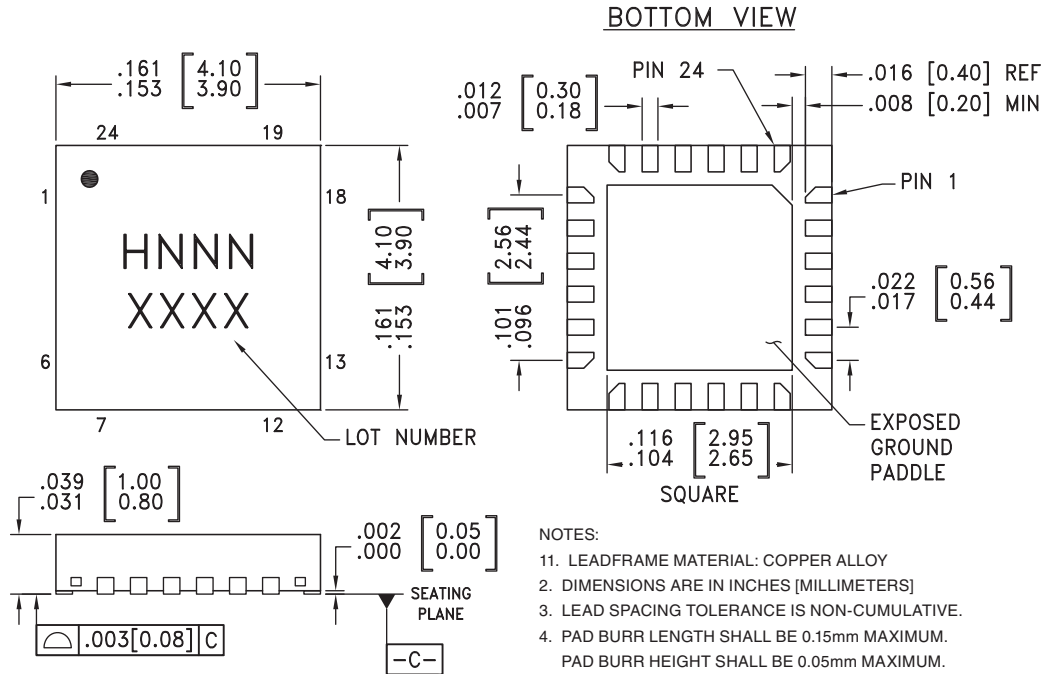

- NOTES:
1. LEADFRAME MATERIAL: COPPER ALLOY
 2. DIMENSIONS ARE IN INCHES [MILLIMETERS]
 3. LEAD SPACING TOLERANCE IS NON-CUMULATIVE.
 4. PAD BURR LENGTH SHALL BE 0.15mm MAXIMUM.
PAD BURR HEIGHT SHALL BE 0.05mm MAXIMUM.
 5. PACKAGE WARP SHALL NOT EXCEED 0.05mm.
 6. ALL GROUND LEADS AND GROUND PADDLE MUST BE SOLDERED TO PCB RF GROUND.
 7. REFER TO HITTITE APPLICATION NOTE FOR SUGGESTED LAND PATTERN.

Package Information

Part Number	Package Body Material	Lead Finish	MSL Rating	Package Marking ^[3]
HMC533LP4	Low Stress Injection Molded Plastic	Sn/Pb Solder	MSL1 ^[1]	H533 XXXX
HMC533LP4E	RoHS-compliant Low Stress Injection Molded Plastic	100% matte Sn	MSL1 ^[2]	H533 XXXX

- [1] Max peak reflow temperature of 235 °C
 [2] Max peak reflow temperature of 260 °C
 [3] 4-Digit lot number XXXX

Pin Descriptions

Pin Number	Function	Description	Interface Schematic
1, 15, 17, 21, 23	GND	Package bottom has an exposed metal paddle that must also be connected to RF/DC ground.	
2	RFOUT/16	Divided-by-16 Output	

Information furnished by Analog Devices is believed to be accurate and reliable. However, no responsibility is assumed by Analog Devices for its use, nor for any infringements of patents or other rights of third parties that may result from its use. Specifications subject to change without notice. No license is granted by implication or otherwise under any patent or patent rights of Analog Devices. Trademarks and registered trademarks are the property of their respective owners.

For price, delivery, and to place orders: Analog Devices, Inc., One Technology Way, P.O. Box 9106, Norwood, MA 02062-9106
 Phone: 781-329-4700 • Order online at www.analog.com
 Application Support: Phone: 1-800-ANALOG-D



Pin Descriptions

Pin Number	Function	Description	Interface Schematic
3, 4	VCC2, VCC3	Supply voltage for prescaler. If prescaler is not required, these pins may be left open to conserve 100 mA of current	
5-14, 18, 19, 24	N/C	No Connection. These pins may be connected to RF/DC ground. Performance will not be affected.	
16	RFOUT	RF output (AC coupled).	
20	VCC1	Supply Voltage, +5V	
22	VTUNE	Control Voltage Input. Modulation port bandwidth dependent on drive source impedance.	

Typical Application Circuit

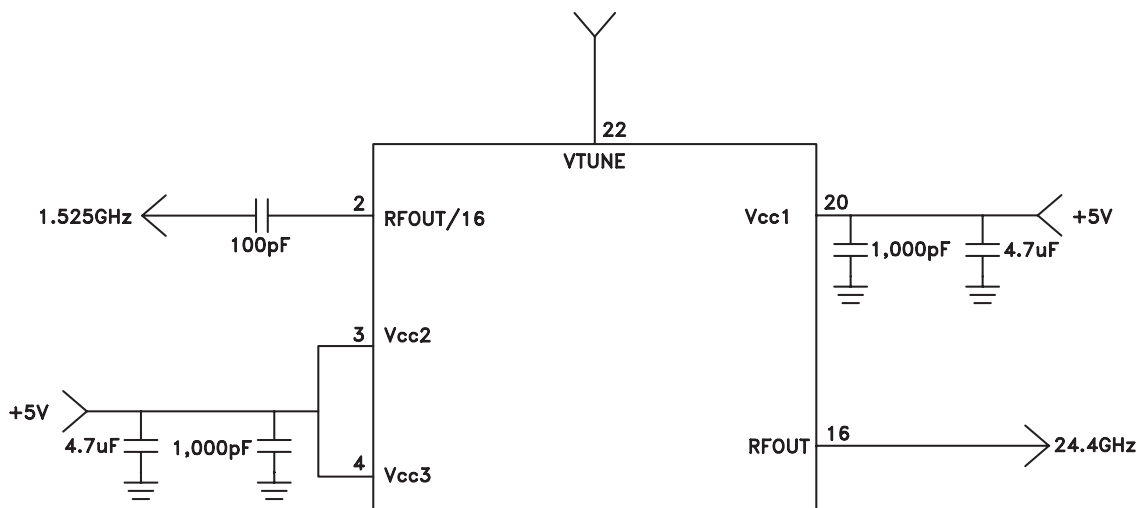

Information furnished by Analog Devices is believed to be accurate and reliable. However, no responsibility is assumed by Analog Devices for its use, nor for any infringements of patents or other rights of third parties that may result from its use. Specifications subject to change without notice. No license is granted by implication or otherwise under any patent or patent rights of Analog Devices. Trademarks and registered trademarks are the property of their respective owners.

For price, delivery, and to place orders: Analog Devices, Inc., One Technology Way, P.O. Box 9106, Norwood, MA 02062-9106 Phone: 781-329-4700 • Order online at www.analog.com Application Support: Phone: 1-800-ANALOG-D



Evaluation PCB

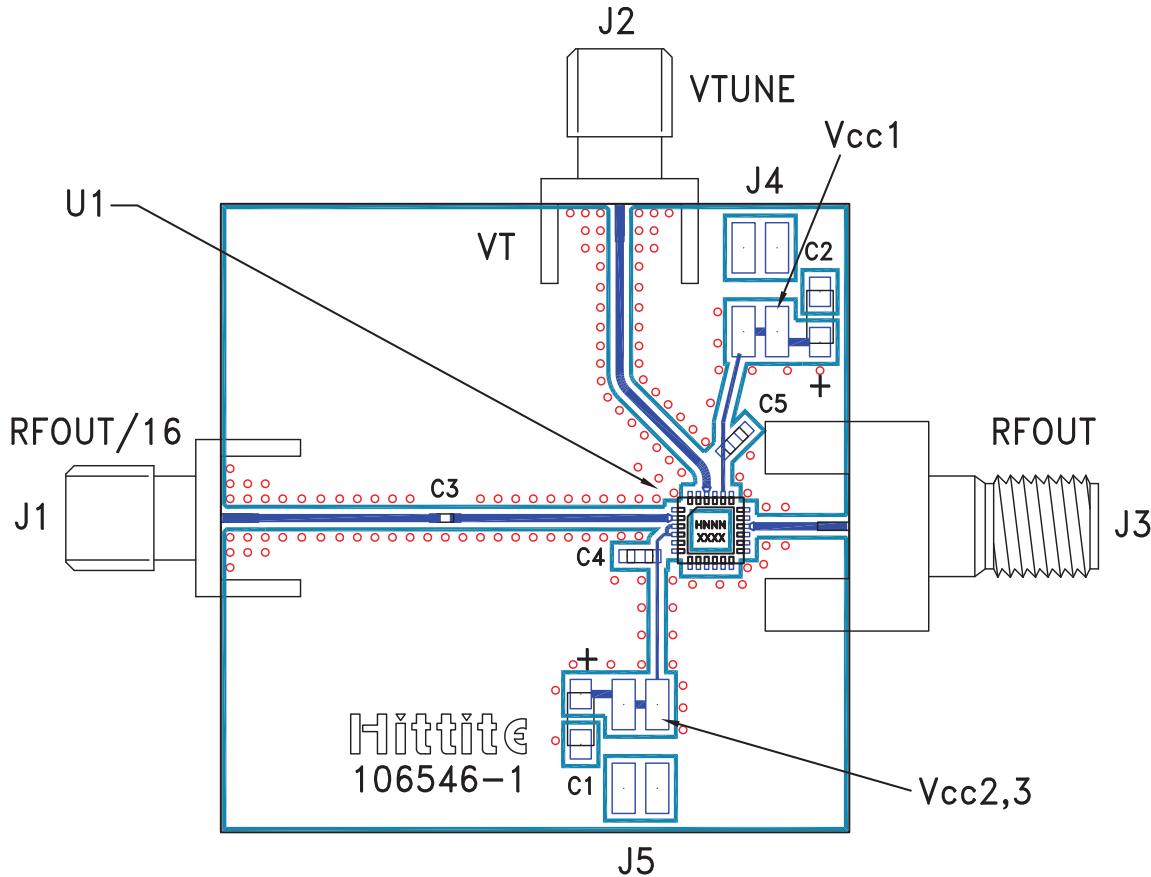

List of Materials for Evaluation PCB 106651 [1]

Item	Description
J1 - J2	PCB Mount SMA RF Connector
J3	2.92 mm PCB mount k-connector
J4 - J5	2 mm DC Header
C1 - C2	4.7 μ F Tantalum Capacitor
C3	100 pF Capacitor, 0402 Pkg.
C4 - C5	1,000 pF Capacitor, 0603 Pkg.
U1	HMC533LP4 / HMC533LP4E VCO
PCB [2]	106546 Eval Board

[1] Reference this number when ordering complete evaluation PCB

[2] Circuit Board Material: Rogers 4350

The circuit board used in the final application should use RF circuit design techniques. Signal lines should have 50 ohm impedance while the package ground leads and backside ground slug should be connected directly to the ground plane similar to that shown. A sufficient number of via holes should be used to connect the top and bottom ground planes. The evaluation circuit board shown is available from Hittite upon request.

Компания «Life Electronics» занимается поставками электронных компонентов импортного и отечественного производства от производителей и со складов крупных дистрибьюторов Европы, Америки и Азии.

С конца 2013 года компания активно расширяет линейку поставок компонентов по направлению коаксиальный кабель, кварцевые генераторы и конденсаторы (керамические, пленочные, электролитические), за счёт заключения дистрибьюторских договоров

Мы предлагаем:

- Конкурентоспособные цены и скидки постоянным клиентам.
- Специальные условия для постоянных клиентов.
- Подбор аналогов.
- Поставку компонентов в любых объемах, удовлетворяющих вашим потребностям.
- Приемлемые сроки поставки, возможна ускоренная поставка.
- Доставку товара в любую точку России и стран СНГ.
- Комплексную поставку.
- Работу по проектам и поставку образцов.
- Формирование склада под заказчика.
- Сертификаты соответствия на поставляемую продукцию (по желанию клиента).
- Тестирование поставляемой продукции.
- Поставку компонентов, требующих военную и космическую приемку.
- Входной контроль качества.
- Наличие сертификата ISO.

В составе нашей компании организован Конструкторский отдел, призванный помогать разработчикам, и инженерам.

Конструкторский отдел помогает осуществить:

- Регистрацию проекта у производителя компонентов.
- Техническую поддержку проекта.
- Защиту от снятия компонента с производства.
- Оценку стоимости проекта по компонентам.
- Изготовление тестовой платы монтаж и пусконаладочные работы.



Тел: +7 (812) 336 43 04 (многоканальный)

Email: org@lifeelectronics.ru