



## SinglFuse™ SF-1206SxxxW Series Features

- Single blow fuse for overcurrent protection
- 3216 (EIA 1206) footprint
- Slow blow fuse
- UL 248-14 listed
- RoHS compliant\* and halogen free\*\*
- Wire core SMD design
- Surface mount packaging for automated assembly

## SF-1206SxxxW Series - Slow Blow Wire Core Surface Mount Fuses

### Electrical Characteristics

| Model           | Rated Current (Amps) | Fusing Time                               | Resistance (Ω) Typ.*** | Rated Voltage | Interrupting Rating | Typical I <sup>2</sup> t (A <sup>2</sup> s) **** |
|-----------------|----------------------|-------------------------------------------|------------------------|---------------|---------------------|--------------------------------------------------|
| SF-1206S150W-2  | 1.50                 | Open within 5 sec. at 250 % rated current | 0.050                  | DC 65 V       | DC 65 V<br>50 A     | 0.37                                             |
| SF-1206S160W-2  | 1.60                 |                                           | 0.043                  |               |                     | 0.52                                             |
| SF-1206S200W-2  | 2.00                 |                                           | 0.032                  |               |                     | 0.88                                             |
| SF-1206S250W-2  | 2.50                 |                                           | 0.028                  |               |                     | 1.10                                             |
| SF-1206S300W-2  | 3.00                 |                                           | 0.022                  |               |                     | 1.90                                             |
| SF-1206S315W-2  | 3.15                 |                                           | 0.020                  |               |                     | 2.20                                             |
| SF-1206S350W-2  | 3.50                 |                                           | 0.018                  |               |                     | 2.60                                             |
| SF-1206S400W-2  | 4.00                 |                                           | 0.016                  |               |                     | 3.30                                             |
| SF-1206S500W-2  | 5.00                 |                                           | 0.013                  | 5.40          |                     |                                                  |
| SF-1206S630W-2  | 6.30                 |                                           | 0.010                  | 8.90          |                     |                                                  |
| SF-1206S700W-2  | 7.00                 |                                           | 0.0092                 | 10.40         |                     |                                                  |
| SF-1206S800W-2  | 8.00                 |                                           | 0.0084                 | 13.50         |                     |                                                  |
| SF-1206S1000W-2 | 10.00                |                                           | 0.0050                 | 11.20         |                     |                                                  |
| SF-1206S1200W-2 | 12.00                |                                           | 0.0041                 | 15.00         |                     |                                                  |
| SF-1206S1500W-2 | 15.00                |                                           | 0.0035                 | 24.50         |                     |                                                  |

\*\*\* Resistance value measured with ≤10 % rated current at 25 °C ambient.

\*\*\*\* Melting I<sup>2</sup>t calculated at 0.001 second pre-arcing time.

### Reliability Testing

| No. | Test                      | Requirement                                                                                           | Test Condition                                                                         | Test Reference         |
|-----|---------------------------|-------------------------------------------------------------------------------------------------------|----------------------------------------------------------------------------------------|------------------------|
| 1   | Reflow and bend           | DCR change ≤ 20 % (≤ 10 % for ≤1 A)<br>No mechanical damage                                           | 3 reflows at 245 °C followed by a 2 mm bend                                            | Refer to STP document  |
| 2   | Solderability             | Minimum 90 % coverage                                                                                 | One dip at 245 °C for 5 seconds                                                        | MIL-STD-202 Method 208 |
| 3   | Soldering heat resistance | DCR change ≤ 20 % (≤ 10 % for ≤1 A)<br>New solder coverage ≤ 75 %                                     | One dip at 260 °C for 10 seconds                                                       | MIL-STD-202 Method 210 |
| 4   | Moisture resistance       | DCR change ≤ ±15 %<br>No excessive corrosion                                                          | 10 cycles                                                                              | MIL-STD-202 Method 106 |
| 5   | Salt spray                | DCR change ≤ ±10 %<br>No excessive corrosion                                                          | 48 hour exposure, 5 % salt solution                                                    | MIL-STD-202 Method 101 |
| 6   | Mechanical vibration      | DCR change ≤ ±10 %<br>No mechanical damage                                                            | 0.4 inch D.A. or 30 G between 5-3000 Hz                                                | MIL-STD-202 Method 204 |
| 7   | Mechanical shock          | DCR change ≤ ±10 %<br>No mechanical damage                                                            | 1500 G, 0.5 ms, half-sine shocks                                                       | MIL-STD-202 Method 213 |
| 8   | Thermal Shock             | DCR change ≤ ±10 %<br>No mechanical damage                                                            | 100 cycles between -65 °C and +125 °C                                                  | MIL-STD-202 Method 107 |
| 9   | Life                      | No electrical "opens" during testing<br>Voltage drop change shall be less than ±20 % of initial value | 80 % rated current (75 % for < 1 A fuses) for 2000 hours at ambient temperature +25 °C | Refer to STP document  |

### Agency Recognition

UL File Number ..... E198545

<http://www.ul.com/> Follow link to Online Certificates Directory, then enter UL File No. E198545, or [click here](#)

\* RoHS Directive 2015/863, Mar 31, 2015 and Annex..

\*\* Bourns considers a product to be "halogen free" if (a) the Bromine (Br) content is 900 ppm or less; (b) the Chlorine (Cl) content is 900 ppm or less; and (c) the total Bromine (Br) and Chlorine (Cl) content is 1500 ppm or less.

"SinglFuse" is a trademark of Bourns, Inc.

Specifications are subject to change without notice.

The device characteristics and parameters in this data sheet can and do vary in different applications and actual device performance may vary over time.

Users should verify actual device performance in their specific applications.

# SingIFuse™ SF-1206SxxxW Series Applications

- LCD monitors
- Backlight drivers
- Set top boxes
- DC/DC converters
- Notebooks / ultrabooks
- Low voltage lighting power
- Industrial controllers

## SF-1206SxxxW Series - Slow Blow Wire Core Surface Mount Fuses **BOURNS®**

### Environmental Characteristics

|                                 |                                 |
|---------------------------------|---------------------------------|
| Operating Temperature.....      | -55 °C to +125 °C               |
| Storage Conditions              |                                 |
| Temperature .....               | +5 °C to +35 °C                 |
| Humidity.....                   | 40 % to 75 %                    |
| Shelf Life.....                 | 2 years from manufacturing date |
| Moisture Sensitivity Level..... | 1                               |
| ESD Classification (HBM).....   | Class 6                         |

### Typical Part Marking

Represents total content. Layout may vary.



|                   |           |
|-------------------|-----------|
| RATED CURRENT (A) |           |
| G = 1.50          | N = 5.00  |
| T = 1.60          | O = 6.30  |
| I = 2.00          | P = 7.00  |
| J = 2.50          | R = 8.00  |
| K = 3.00          | Q = 10.00 |
| V = 3.15          | X = 12.00 |
| L = 3.50          | Y = 15.00 |
| M = 4.00          |           |

### How to Order

**SF - 1206 S 150 W - 2**

SingIFuse™  
 Product Designator  
 SMD Footprint  
 1206 = 3216 (EIA1206) size  
 Fuse Blow Type  
 S = Slow Blow  
 Rated Current  
 150 ~ 1500 (1.50 A ~ 15.00 A)  
 Structure Type  
 W = Wire Core  
 Packaging Type  
 - 2 = Tape & Reel

### Construction

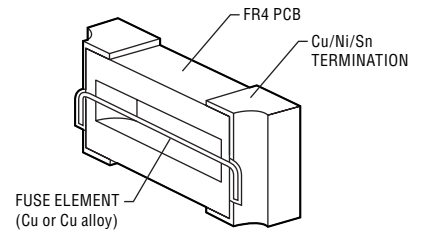

### Packaging Quantity

3,500 pieces per 7-inch reel

### Product Dimensions

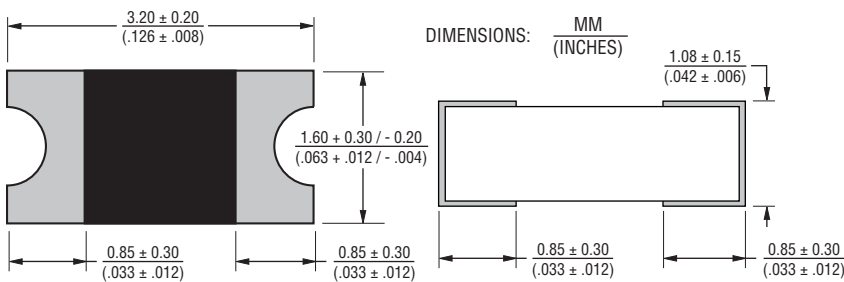

### Recommended Pad Layout

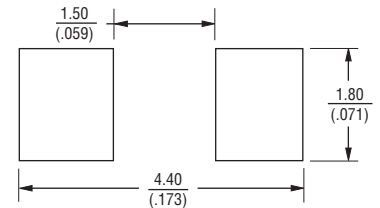

### Current Rating Thermal Derating Curve

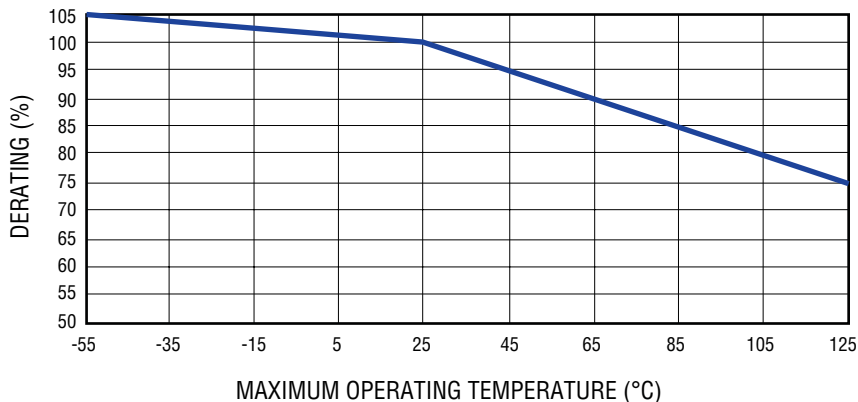

Specifications are subject to change without notice.  
 The device characteristics and parameters in this data sheet can and do vary in different applications and actual device performance may vary over time.  
 Users should verify actual device performance in their specific applications.

**Solder Reflow Recommendations**



| Profile Feature                                                                                                                           | Pb-Free Assembly                   |
|-------------------------------------------------------------------------------------------------------------------------------------------|------------------------------------|
| Preheat / Soak:<br>Temperature Min. ( $T_{smin}$ )<br>Temperature Max. ( $T_{smax}$ )<br>Time ( $t_s$ ) from ( $T_{smin}$ to $T_{smax}$ ) | 150 °C<br>200 °C<br>60~120 seconds |
| Ramp Up Rate ( $T_L$ to $T_d$ )                                                                                                           | 3 °C / second max.                 |
| Liquidous Temperature ( $T_L$ )<br>Time ( $t_L$ ) maintained above $T_L$                                                                  | 217 °C<br>60~150 seconds           |
| Peak Package Body Temperature ( $T_d$ )                                                                                                   | 260 °C                             |
| Time ( $t_p$ )* within 5 °C of the specified classification temperature ( $T_c$ )                                                         | 30 seconds*                        |
| Ramp Down Rate ( $T_d$ to $T_L$ )                                                                                                         | 6 °C / second max.                 |
| Time 25 °C to Peak Temperature                                                                                                            | 8 minutes max.                     |

\* Tolerance for peak profile temperature ( $T_p$ ) is defined as a supplier minimum and a user maximum.

**Recommended Temperature Profile for Wave Soldering**

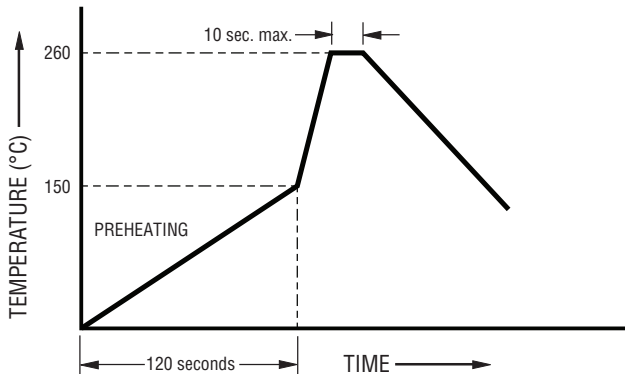

Wave soldering is suitable for 1206 size models.

Average Pre-Arcing Time vs. Current Curves

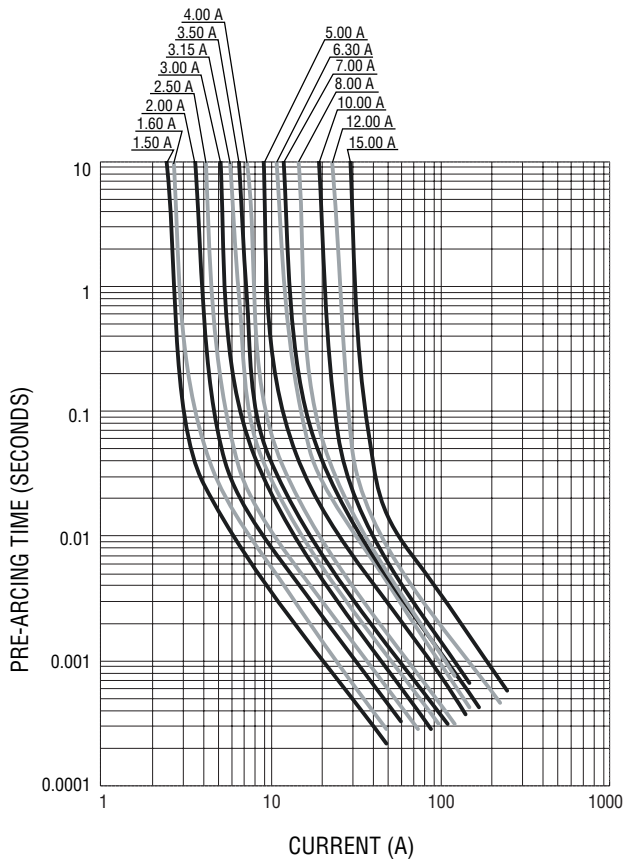

Average I<sup>2</sup>t vs. t Curves

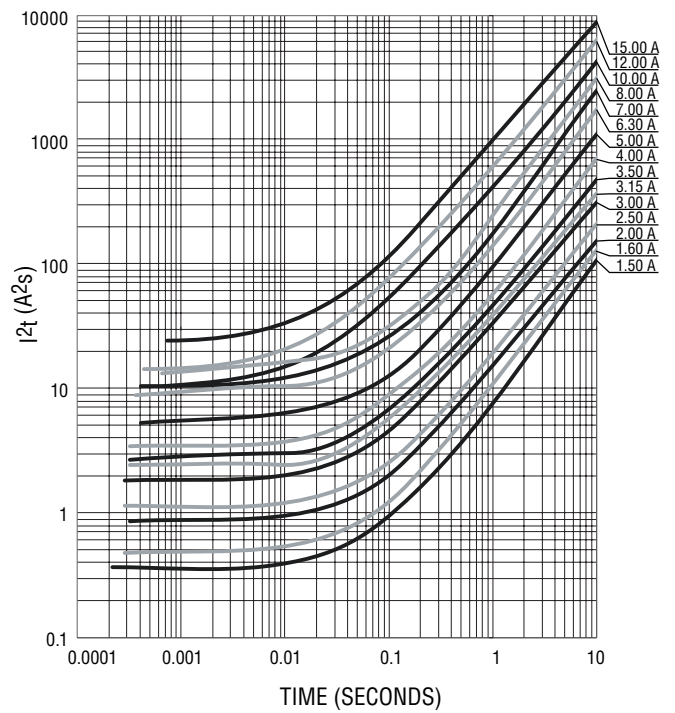

**BOURNS®**

Asia-Pacific: Tel: +886-2 2562-4117 • Email: asiacus@bourns.com

EMEA: Tel: +36 88 520 390 • Email: eurocus@bourns.com

The Americas: Tel: +1-951 781-5500 • Email: americus@bourns.com

www.bourns.com

# SF-1206SxxxW Series Tape and Reel Packaging Specifications

# BOURNS®

| Tape Dimensions | SF-1206SxxxW Series<br>per EIA 481-2    |
|-----------------|-----------------------------------------|
| W               | $\frac{8.10 \pm 0.20}{(.319 \pm .008)}$ |
| P <sub>0</sub>  | $\frac{4.0 \pm 0.10}{(.157 \pm .004)}$  |
| P <sub>1</sub>  | $\frac{4.0 \pm 0.10}{(.157 \pm .004)}$  |
| P <sub>2</sub>  | $\frac{2.0 \pm 0.05}{(.079 \pm .002)}$  |
| A <sub>0</sub>  | $\frac{2.05 \pm 0.10}{(.081 \pm .004)}$ |
| B <sub>0</sub>  | $\frac{3.50 \pm 0.10}{(.138 \pm .004)}$ |
| F               | $\frac{3.50 \pm 0.05}{(.138 \pm .002)}$ |
| E <sub>1</sub>  | $\frac{1.75 \pm 0.10}{(.069 \pm .004)}$ |
| D <sub>0</sub>  | $\frac{1.50 \pm 0.10}{(.059 \pm .004)}$ |
| K <sub>0</sub>  | $\frac{1.30 \pm 0.10}{(.051 \pm .004)}$ |
| T               | $\frac{0.22 \pm 0.05}{(.009 \pm .002)}$ |

PACKAGING: Plastic tape, 3,500 pcs. per reel

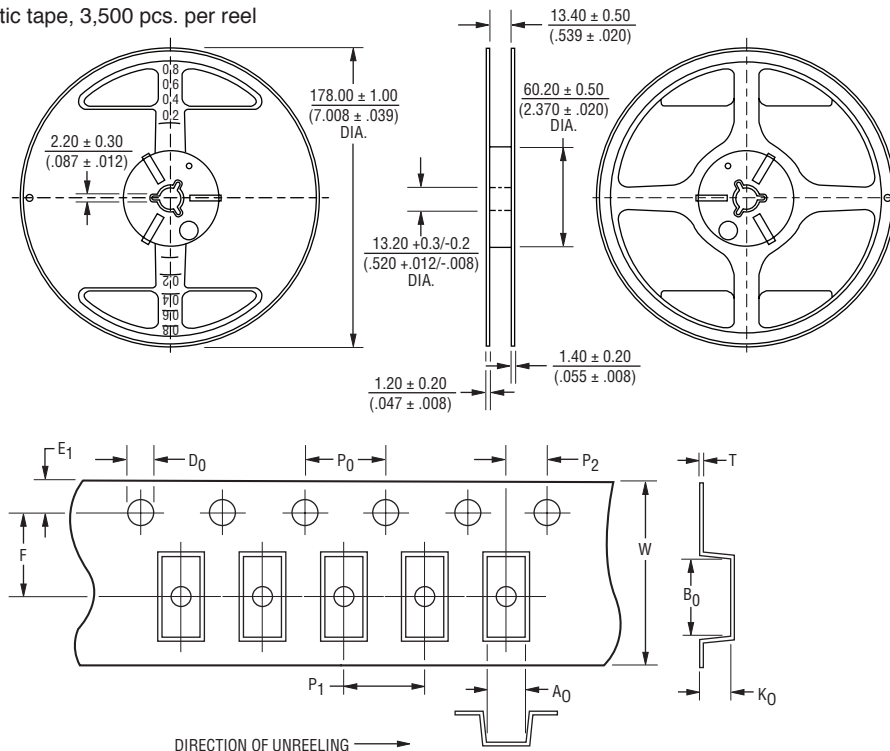

DIMENSIONS:  $\frac{\text{MM}}{(\text{INCHES})}$

Specifications are subject to change without notice.  
 The device characteristics and parameters in this data sheet can and do vary in different applications and actual device performance may vary over time.  
 Users should verify actual device performance in their specific applications.

Компания «Life Electronics» занимается поставками электронных компонентов импортного и отечественного производства от производителей и со складов крупных дистрибьюторов Европы, Америки и Азии.

С конца 2013 года компания активно расширяет линейку поставок компонентов по направлению коаксиальный кабель, кварцевые генераторы и конденсаторы (керамические, пленочные, электролитические), за счёт заключения дистрибьюторских договоров

Мы предлагаем:

- Конкуренспособные цены и скидки постоянным клиентам.
- Специальные условия для постоянных клиентов.
- Подбор аналогов.
- Поставку компонентов в любых объемах, удовлетворяющих вашим потребностям.
- Приемлемые сроки поставки, возможна ускоренная поставка.
- Доставку товара в любую точку России и стран СНГ.
- Комплексную поставку.
- Работу по проектам и поставку образцов.
- Формирование склада под заказчика.
- Сертификаты соответствия на поставляемую продукцию (по желанию клиента).
- Тестирование поставляемой продукции.
- Поставку компонентов, требующих военную и космическую приемку.
- Входной контроль качества.
- Наличие сертификата ISO.

В составе нашей компании организован Конструкторский отдел, призванный помогать разработчикам, и инженерам.

Конструкторский отдел помогает осуществить:

- Регистрацию проекта у производителя компонентов.
- Техническую поддержку проекта.
- Защиту от снятия компонента с производства.
- Оценку стоимости проекта по компонентам.
- Изготовление тестовой платы монтаж и пусконаладочные работы.



Тел: +7 (812) 336 43 04 (многоканальный)  
Email: [org@lifeelectronics.ru](mailto:org@lifeelectronics.ru)