

4.7 x 4.1mm BUILT-IN CAPACITANCE CERAMIC RESONATOR

AWSCR-MTD

Pb in ceramic
(exempt per RoHS 2002/95/EC Annex (7))

RoHS
Compliant



4.7 x 4.1mm

FEATURES:

- Low resonant impedance
- Built-in load capacitors
- IR reflow capable

APPLICATIONS:

- Remote controls, Microprocessor clocks, Mobile phones, DVD & CD-Roms, Electric appliances, Industrial controllers
- Consumer electronics

STANDARD SPECIFICATIONS:

Item	Requirement
Frequency Range	6.00MHz to 50.00MHz
Resonant Impedance	See Table 2.1
Frequency Tolerance	± 0.5%
Frequency Stability max. (-25°C to +85°C)	±0.4% (6.00 MHz~13.00 MHz)* ±0.3% (13.01 MHz~50.00 MHz)
Withstanding Voltage (V)	50 (DC , 1 min)
Rating Voltage (1) D.C.Voltage (2) A.C. Voltage	6 V.D.C. max 15 Vp-p. max
Built-in Capacitance	See Table 2.1
Insulation Resistance	100MΩ min. (10V, 1min)
Operation Temperature	-25°C to +85°C*
Storage Temperature	-55°C to +85°C
Aging Rate (Fosc)	±0.3% max. (10 years)

Table 2.1

Frequency Range (MHz)	Resonant Impedance (Ro)(Ω)	Standard Built-in Capacitance C1=C2 (pF)
6.00 MHz - 13.00 MHz	30	22pF ±20%
13.01 MHz - 16.00 MHz	40	22pF ±20%
16.01 MHz - 25.99 MHz	40	10pF ±20%
26.00 MHz - 50.00 MHz	40	5pF ±20%

* Please contact ABRACON for tighter stability and/or wider temperature range

TEST CIRCUIT:

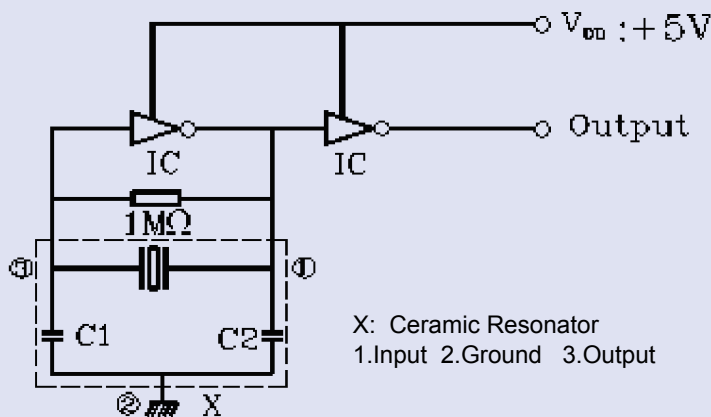

Parts shall be measured under a condition (Temp.: 20±15°C, Humidity: 65±20% R.H.) unless the standard condition (Temp: 25±3°C, Humidity: 65±10% R.H.) is regulated to measure

OPTIONS AND PART IDENTIFICATION:

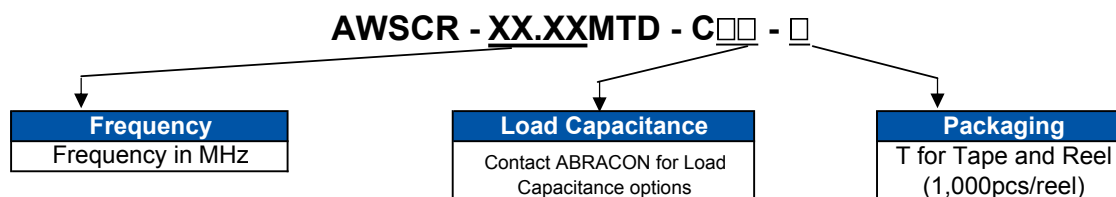

4.7 x 4.1mm BUILT-IN CAPACITANCE CERAMIC RESONATOR

AWSCR-MTD

Pb in ceramic
(exempt per RoHS 2002/95/EC Annex (7))

RoHS
Compliant



4.7 x 4.1mm

OUTLINE DRAWING:

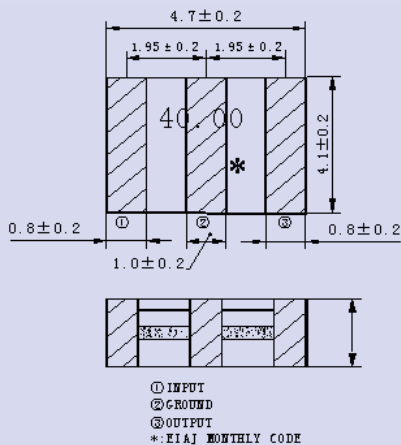

RECOMMENDED LAND PATTERN

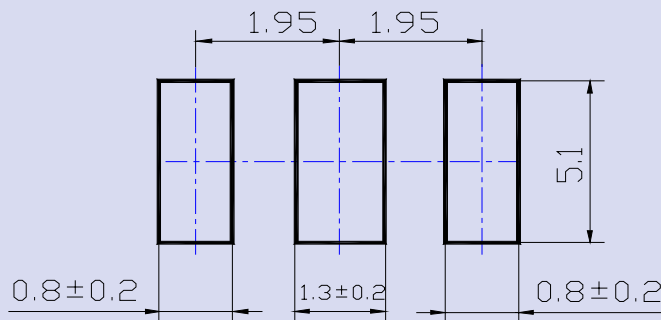

Dimension : mm

TAPE & REEL: [1,000pcs/reel]

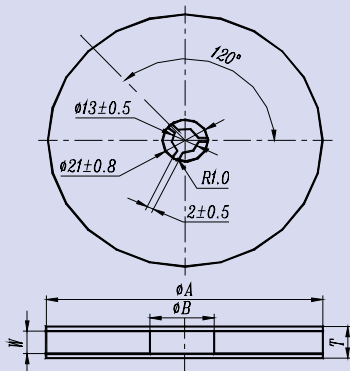

ϕA	ϕB	W	T	Pieces per reel	Carrier tape size
180 ± 3	60min	12.4min	19.4max	1000typ.	12

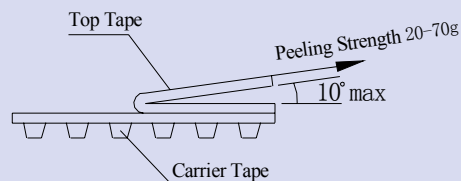
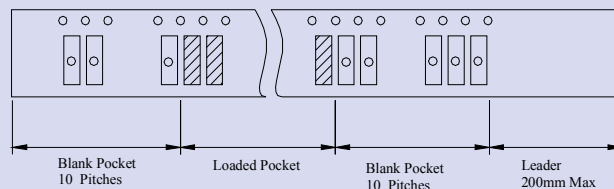

Dimension : mm

4.7 x 4.1mm BUILT-IN CAPACITANCE CERAMIC RESONATOR

AWSCR-MTD

Pb in ceramic
(exempt per RoHS 2002/95/EC Annex (7))

RoHS
Compliant

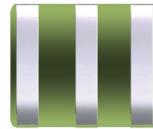

4.7 x 4.1mm

REFLOW PROFILE:

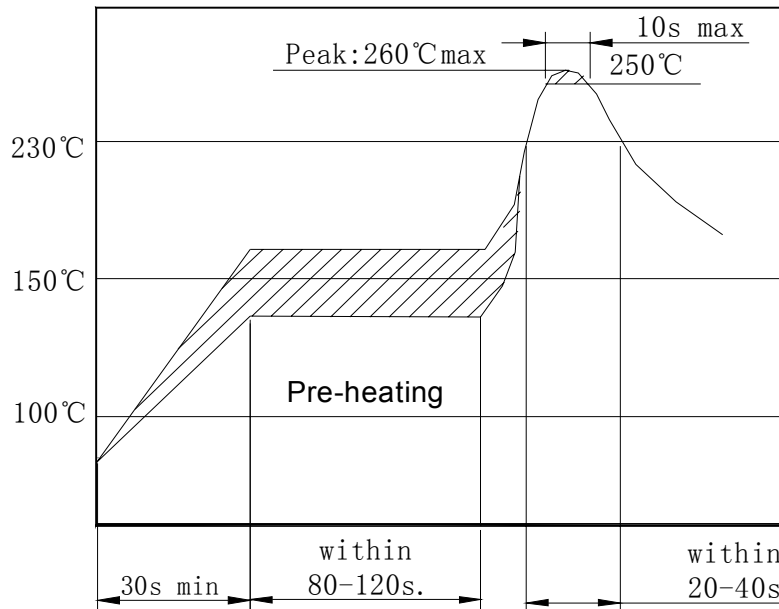

CAUTION

- Do not apply excess mechanical stress to the component body or terminations. Do not attempt to re-form or bend the components as this will cause damage to the component.
- This component is not hermetically sealed. Do not clean or wash the component.
- Reflow soldering: Do not use strong acidity flux, such as flux with chlorine content of greater than 0.2wt% during reflow Soldering.
- Do not expose the component to open flame.
- This specification applies to the functionality of the component as a single unit. Customers are advised to insure that the component is thoroughly evaluated in the particular application.
- Shelf life: The warranted shelf life of this product is six months after the delivery date under the conditions of sealed, unopened, original packaging.
- Storage conditions: If the product is to be stored for a period greater than six months after the delivery date, it is recommended that customers confirm the solderability and characteristics for the product prior to use.
- This product is not recommended for use in the following applications: Automotive, Medical, Military, Safety, or any other high-reliability, life-dependant application. Contact Abracon Corporation prior to using this product when in doubt.

ATTENTION: Abracon Corporation's products are COTS - Commercial-Off-The-Shelf products; suitable for Commercial, Industrial and, where designated, Automotive Applications. Abracon's products are not specifically designed for Military, Aviation, Aerospace, Life-dependant Medical applications or any application requiring high reliability where component failure could result in loss of life and/or property. For applications requiring high reliability and/or presenting an extreme operating environment, written consent and authorization from Abracon Corporation is required. Please contact Abracon Corporation for more information.

ABRACON IS
ISO9001:2008
CERTIFIED



Visit www.abracon.com for Terms & Conditions of Sale **Revised: 09.12.10**
30332 Esperanza, Rancho Santa Margarita, California 92688
tel 949-546-8000 | fax 949-546-8001 | www.abracon.com

Компания «Life Electronics» занимается поставками электронных компонентов импортного и отечественного производства от производителей и со складов крупных дистрибьюторов Европы, Америки и Азии.

С конца 2013 года компания активно расширяет линейку поставок компонентов по направлению коаксиальный кабель, кварцевые генераторы и конденсаторы (керамические, пленочные, электролитические), за счёт заключения дистрибьюторских договоров

Мы предлагаем:

- Конкурентоспособные цены и скидки постоянным клиентам.
- Специальные условия для постоянных клиентов.
- Подбор аналогов.
- Поставку компонентов в любых объемах, удовлетворяющих вашим потребностям.
- Приемлемые сроки поставки, возможна ускоренная поставка.
- Доставку товара в любую точку России и стран СНГ.
- Комплексную поставку.
- Работу по проектам и поставку образцов.
- Формирование склада под заказчика.
- Сертификаты соответствия на поставляемую продукцию (по желанию клиента).
- Тестирование поставляемой продукции.
- Поставку компонентов, требующих военную и космическую приемку.
- Входной контроль качества.
- Наличие сертификата ISO.

В составе нашей компании организован Конструкторский отдел, призванный помогать разработчикам, и инженерам.

Конструкторский отдел помогает осуществить:

- Регистрацию проекта у производителя компонентов.
- Техническую поддержку проекта.
- Защиту от снятия компонента с производства.
- Оценку стоимости проекта по компонентам.
- Изготовление тестовой платы монтаж и пусконаладочные работы.



Тел: +7 (812) 336 43 04 (многоканальный)

Email: org@lifeelectronics.ru