

IB IL CNT-XC-PAC

Inline counter terminal, version for extreme conditions, 1 counter input, 1 control input, 1 output, 24 V DC, 500 mA

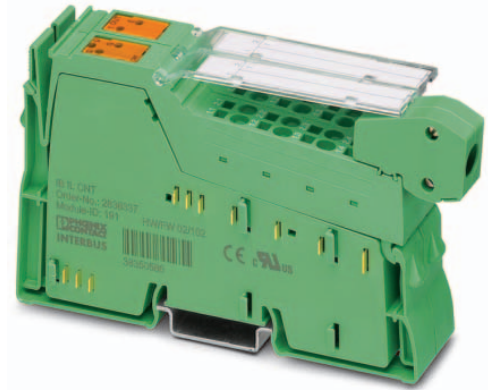

Data sheet
106148_en_03

© PHOENIX CONTACT 2015-11-04

1 Description

The terminal is designed for use within an Inline station.

The counter terminal detects and processes fast pulse sequences from sensors. It has a counter input (source), a control input (gate), and a switching output that can be freely parameterized by the module itself. In this way, it is possible to achieve fast response times that are independent of both the bus and controller.

The terminal can be operated in four different modes: frequency measurement, event counting, time measurement, and pulse generation (pulse generator).

Thanks to special engineering measures and tests, the terminal can be used under extreme ambient conditions.

Features

- 1 counter input for 24 V or 5 V signals
- 1 control input for 24 V or 5 V signals
- 1 freely parameterizable switching output
- Diagnostic and status indicators
- Can be used under extreme ambient conditions
- Extended temperature range of -40°C ... +70°C (see "Tested successfully: use under extreme ambient conditions")
- Painted PCBs



This data sheet is only valid in association with the IL SYS INST UM E user manual.



For additional information, please refer to the user manual for the counter terminal.



Make sure you always use the latest documentation.
It can be downloaded from the product at phoenixcontact.net/products.

2	Table of contents	
1	Description	1
2	Table of contents	2
3	Ordering data	3
4	Technical data	3
5	Additional tables	7
6	Tested successfully: Use under extreme ambient conditions	8
7	Internal circuit diagram	8
8	Terminal point assignment.....	9
9	Connection example.....	9
10	Local status and diagnostic indicators	10
11	Function description	10

3 Ordering data

Description	Type	Order No.	Pcs./Pkt.
Inline counter terminal, version for extreme conditions, complete with accessories (connectors and marking fields), 1 counter input, 1 control input, 1 output, 24 V DC, 500 mA, 3-conductor connection technology	IB IL CNT-XC-PAC	2702134	1
Accessories	Type	Order No.	Pcs./Pkt.
Connector set (Connector/Adapter)	IB IL AO/CNT-PLSET	2732664	1
Labeling field, width: 12.2 mm (Marking)	IB IL FIELD 2	2727501	10
Insert strip, Sheet, white, unlabeled, can be labeled with: Office printing systems, Plotter: Laser printer, Mounting type: Insert, Lettering field: 62 x 10 mm (Marking)	ESL 62X10	0809492	1
Connector, for digital 1, 2 or 8-channel Inline terminals (Connector/Adapter)	IB IL SCN-8	2726337	10
Inline shield connector (Connector/Adapter)	IB IL SCN-6 SHIELD	2726353	5
Documentation	Type	Order No.	Pcs./Pkt.
User manual, English, Inline Modular counter terminal	IB IL CNT UM E	-	-
User manual, English, Automation terminals of the Inline product range	IL SYS INST UM E	-	-
Data sheet, English, INTERBUS addressing	DB GB IBS SYS ADDRESS	-	-

4 Technical data

Dimensions (nominal sizes in mm)

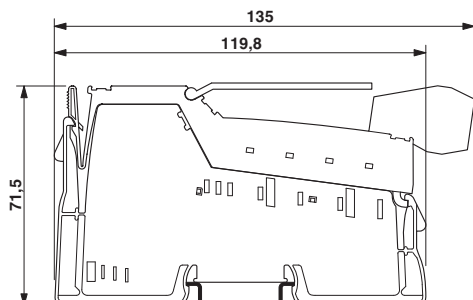

Width	24.4 mm
Height	135 mm
Depth	71.5 mm
Note on dimensions	Housing dimensions

General data

Color	green
Weight	130 g (with connectors)
Operating mode	Process data operation with 2 words
Ambient temperature (operation)	-25 °C ... 55 °C (Standard) -40 °C ... 70 °C (Extended, see section "Tested successfully: use under extreme ambient conditions" in the data sheet.)
Ambient temperature (storage/transport)	-40 °C ... 85 °C
Permissible humidity (operation)	10 % ... 95 % (according to DIN EN 61131-2)
Permissible humidity (storage/transport)	10 % ... 95 % (according to DIN EN 61131-2)

General data

Air pressure (operation)	70 kPa ... 106 kPa (up to 3000 m above sea level)
Air pressure (storage/transport)	70 kPa ... 106 kPa (up to 3000 m above sea level)
Degree of protection	IP20
Protection class	III, IEC 61140, EN 61140, VDE 0140-1

Connection data

Designation	Inline connector
Connection method	Spring-cage connection
Conductor cross section solid / stranded	0.08 mm ² ... 1.5 mm ² / 0.08 mm ² ... 1.5 mm ²
Conductor cross section [AWG]	28 ... 16
Stripping length	8 mm

Connection data for UL approvals

Designation	Inline connector
Connection method	Spring-cage connection
Conductor cross section solid / stranded	0.2 mm ² ... 1.5 mm ² / 0.2 mm ² ... 1.5 mm ²
Conductor cross section [AWG]	24 ... 16

Interface Inline local bus

Connection method	Inline data jumper
Transmission speed	500 kBit/s
Transmission physics	Copper

Supply: Power supply for sensors

Supply voltage	24 V DC (generated from segment supply U _S)
Current carrying capacity	max. 500 mA
Behavior in case of short-circuit	Auto restart after eliminating the short-circuit

Power consumption

Segment supply voltage U _S	24 V DC (nominal value)
Current consumption from U _S	max. 1 A
Communications power U _L	7.5 V DC (via voltage jumper)
Current consumption from U _L	typ. 40 mA max. 50 mA
Power consumption	max. 0.375 W (at U _L)

Counter input for 24 V signals

Number of inputs	1 (only one counter input can be used, either for 24 V or for 5 V signals)
Operating mode	Event counting, frequency/time measurement
Connection method	Spring-cage connection
Connection method	2, 3-wire
Input voltage	24 V DC (Nominal voltage)
Nominal input current	typ. 5 mA
Input voltage range "0" signal	0 V DC ... 5 V DC
Input voltage range "1" signal	15 V DC ... 30 V DC
Input resistance	approx. 5.7 kΩ

Counter input for 5 V signals

Number of inputs	1 (only one counter input can be used, either for 24 V or for 5 V signals)
Operating mode	Event counting, frequency/time measurement
Connection method	Spring-cage connection

Counter input for 5 V signals

Connection method	2-wire (shielded), external 5 V supply
Input voltage	5 V DC (Nominal voltage)
Nominal input current	typ. 5 mA
Input voltage range "0" signal	0 V ... 1.5 V
Input voltage range "1" signal	3.5 V ... 8 V
Input resistance	approx. 1.7 k Ω

Control input for 24 V signals

Number of inputs	1 (only one control input can be used, either for 24 V or for 5 V signals)
Operating mode	Event counting, frequency/time measurement
Connection method	Spring-cage connection
Connection method	2, 3-wire
Input voltage	24 V DC (Nominal voltage)
Nominal input current	typ. 5 mA
Input voltage range "0" signal	0 V ... 5 V
Input voltage range "1" signal	15 V ... 30 V
Input resistance	approx. 5.7 k Ω

Control input for 5 V signals

Number of inputs	1 (only one control input can be used, either for 24 V or for 5 V signals)
Operating mode	Event counting, frequency/time measurement
Connection method	Spring-cage connection
Connection method	2-wire (shielded), external 5 V supply
Input voltage	5 V DC (Nominal voltage)
Nominal input current	typ. 5 mA
Input voltage range "0" signal	0 V ... 1.5 V
Input voltage range "1" signal	3.5 V ... 8 V
Input resistance	approx. 1.7 k Ω

Switching output

Number of outputs	1
Connection method	Spring-cage connection
Connection method	2-wire
Output voltage	24 V DC (Nominal voltage)
Output current	max. 0.5 A (Nominal current)
Voltage difference with nominal current	< 1 V
Nominal load, ohmic	max. 12 W (48 Ω)
Nominal load, inductive	max. 12 VA (1.2 H; 48 Ω)
Nominal load, lamp	max. 12 W
Signal delay when switching on an ohmic nominal load	< 50 μ s
Signal delay when switching on an inductive nominal load	< 1 ms
Signal delay when switching on a lamp nominal load	< 25 μ s
Signal delay when switching off an ohmic nominal load	< 1 ms
Signal delay when switching off an inductive nominal load	< 30 ms
Signal delay when switching off a lamp nominal load	< 1 ms
Limitation of the voltage induced on circuit interruption	approx. -18 V
Behavior in the event of ohmic overload	Auto restart after eliminating the overload
Behavior with inductive overload	Output can be destroyed
Behavior in the event of lamp overload	Auto restart after eliminating the overload

Switching output



The characteristics of a bulb can delay the auto restart significantly after eliminating the overload. The delay time can be reduced by briefly setting the output.

Reverse voltage resistance to short pulses	Reverse voltage proof
Resistance to permanently applied surge voltage	No
Overcurrent shut-down	min. 0.7 A
Short-circuit protection	Yes, short-circuit-proof (automatically switched on again)
Overload protection	Yes

Programming data (INTERBUS, local bus)

ID code (hex)	BF
ID code (dec.)	191
Length code (hex)	02
Length code (dec.)	02
Process data channel	32 Bit
Input address area	4 Byte
Output address area	4 Byte
Parameter channel (PCP)	0 Byte
Register length (bus)	4 Byte



For the programming data/configuration data of other bus systems, please refer to the corresponding electronic device data sheet (e.g., GSD, EDS).



NOTE: Misinterpretation of values when the data consistency is violated
Ensure data consistency of two words to prevent the possibility of the values being misinterpreted.

Configuration and parameter data in a PROFIBUS system

Required parameter data	1 Byte
Need for configuration data	5 Byte

Error messages to the higher level control or computer system

Sensor supply short-circuit	
Sensor supply overload	



If the sensor supply is short-circuited, the red E LED (Error) lights up and an I/O error message is generated after a delay of typically 1.4 s. In addition, the D LED (Diagnostics) flashes on the terminal at 2 Hz (medium).

Electrical isolation/isolation of the voltage areas

Test section	Test voltage
5 V supply, incoming remote bus/7.5 V supply (bus logics)	500 V AC, 50 Hz, 1 min
5 V supply, outgoing remote bus/7.5 V supply (bus logics)	500 V AC, 50 Hz, 1 min
7.5 V supply (bus logics)/24 V supply (I/O)	500 V AC, 50 Hz, 1 min
24 V supply (I/O) / functional earth ground	500 V AC, 50 Hz, 1 min



To achieve electrical isolation between the logic level and the I/O area, supply these areas from separate power supply units. Interconnection of the power supply units in the 24 V area is not permitted (see also user manual).

Approvals

For the latest approvals, please visit phoenixcontact.net/products.

5 Additional tables

Control and counter input	
Input characteristic curve	
Input voltage (V)	Typical input current (mA)
$-0.5 < U_{IN} < 0$	0
3	0.6
6	1.1
9	1.7
12	2.3
15	2.4
18	3.6
21	4.3
24	5.0
27	5.5
30	6.1

Switching output	
Output characteristic curve when switched on (typical)	
Output current (A)	Differential output voltage (V)
0	0
0.1	0.25
0.2	0.35
0.3	0.45
0.4	0.55
0.5	0.65

Sensor supply	
Output characteristic curve when switched on (typical)	
Output current (A)	Differential output voltage (V)
0	0
0.1	0.18
0.2	0.22
0.3	0.27
0.4	0.31
0.5	0.36

Limit values and limitations in the operating modes			
Operating mode	Affected option	Operating range	
Frequency measurement	All	$f \leq 100 \text{ kHz}$	
Event counting	All	$f \leq 100 \text{ kHz}$	
Time measurement	Resolution 2 μs	Without relation condition	$250 \mu\text{s} \leq t \leq 126 \text{ ms}$
		With relation condition	$1 \text{ ms} \leq t \leq 126 \text{ ms}$
	Resolution 2 ms		$2 \text{ ms} \leq t \leq 131 \text{ s}$
	Resolution 10 ms		$10 \text{ ms} \leq t \leq 655 \text{ s}$
Pulse generator		$1 \text{ kHz} \leq f \leq 10 \text{ kHz}$	

Notes on using the counter terminal

Minimum time measurement period The minimum time measurement periods with a resolution of 2 μs , with and without relation condition, are defined by the firmware by means of the processing time.

Input signals at source and gate The input signals at source and gate must be digital.

Switch The counter terminal is primarily designed for the use of electronic switching elements, i.e., semiconductor switches.

Mechanical contacts can only be used to a limited extent. A filter is provided in the input circuit for this purpose. However, practical tests have shown that the bouncing of mechanical contacts can present problems even with this filter.

6 Tested successfully: Use under extreme ambient conditions

XC terminals have been tested successfully over 250 temperature change cycles in accordance with IEC 61131-2 in the range from -40°C to +70°C.

The following conditions were observed:

- The Inline devices for all connecting cables were connected with a minimum conductor cross section of 0.5 mm²
- The Inline station was assembled on a wall-mounted horizontal DIN rail
- Fans were used to ensure continuous movement of air in the control cabinet
- The Inline station was not exposed to vibration or shock
- The Inline station was operated with a maximum of 24.5 V (ensured by using regulated power supply units)

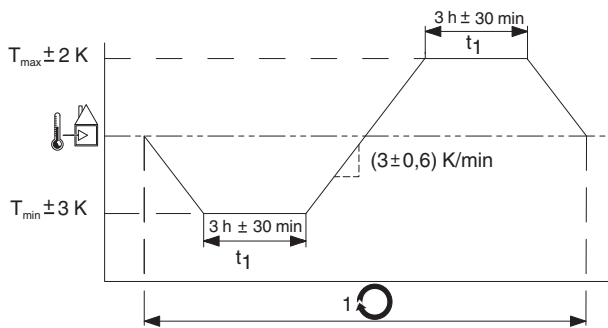

Figure 1 Temperature change cycle



Temperature in the control cabinet/ambient temperature



Cycle



WARNING:

The terminal is not approved for use in potentially explosive areas.

The terminal is not approved for use in safety technology.

7 Internal circuit diagram

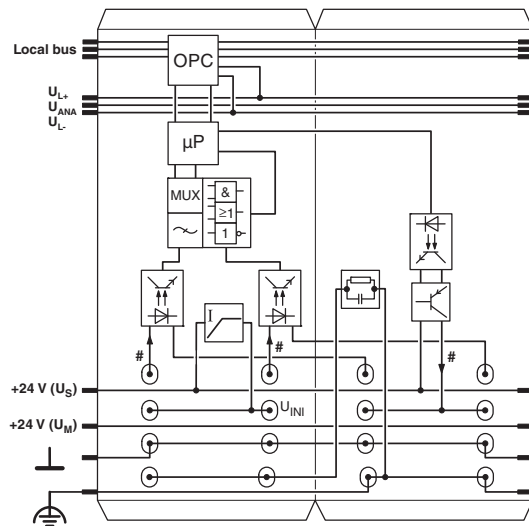



Figure 2 Internal wiring of the terminal points

Key:

Local bus Local bus
 Protocol chip
 (Bus logic including voltage conditioning)



Microprocessor

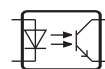

Optocoupler



Digital input



Digital output



Transistor



Coupling network



Module with multiplexer, filter, and logic



Sensor supply with short-circuit protection



Explanation for other used symbols has been provided in the IL SYS INST UM E user manual.

8 Terminal point assignment

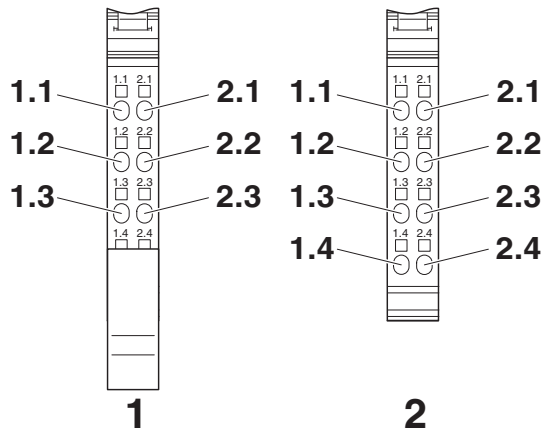

Figure 3 Terminal point assignment

Terminal point	Signal	Assignment
Connector 1		
1.1	S+	24 V counter input (source)
2.1	G+	24 V control input (gate)
1.2, 2.2	U_{INI}	24 V DC sensor voltage
1.3	S-	Reference ground for the counter input (source) and the sensor voltage
2.3	G-	Reference ground for the control input (gate) and the sensor voltage
1.4, 2.4	Shield	Shield (capacitively coupled to FE)
Connector 2		
1.1	S+*	5 V counter input (source)
2.1	G+*	Control input 5 V (gate)
1.2, 2.2	OUT	Output; the terminal points are jumpered internally.
1.3, 2.3	GND	Reference ground for the output; the terminal points are jumpered internally.
1.4, 2.4	FE	Functional earth ground (connected directly to FE)



The short-circuit-protected sensor voltage U_{INI} is generated from the segment voltage U_S . The main voltage U_M is not used at the counter terminal points.

9 Connection example

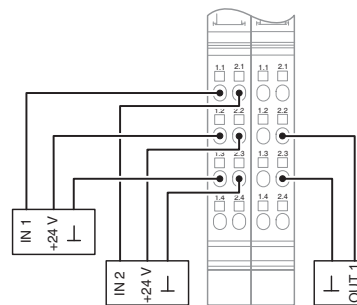

Figure 4 Connection example



When connecting the sensors observe the assignment of the terminal points to the process data.

This can be found in the user manual for the counter terminal.

10 Local status and diagnostic indicators

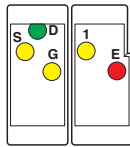

Figure 5 Local status and diagnostic indicators

Designation	Color	Meaning
D	Green	Diagnostics (bus and logic voltage)
	ON	Local bus active.
	Flashing	
	0.5 Hz: (slow)	Communications power not present, bus system is not active
	2 Hz: (medium)	Communications power present, bus active, I/O error.
	4 Hz: (fast)	Communications power present, bus connection to the flashing terminal has failed; terminals behind the flashing terminal are not part of the configuration frame
	OFF	Communications power not present, bus system is not active
E	Red	Sensor supply short-circuit
	ON	Connector 1 short-circuited between terminals 1.2 and 1.3 or between terminals 2.2 and 2.3
	OFF	No error
S	Yellow	Status of the counter input (source)
	ON	Input is active.
	OFF	Input is inactive.
G	Yellow	Status of the control input (gate)
	ON	Input is active.
	OFF	Input is inactive.
1	Yellow	Output status
	ON	Output is set.
	OFF	Output is not set.

Function identification

Orange

11 Function description



An overview of the function of the terminal is provided here. For a more detailed description, please refer to the user manual for the counter terminal.

- Event counting:
The counting conditions and the output switching behavior can be selected.
- Frequency measurement:
Time-driven or state-driven frequency measurements with gate times (time in which measurement is performed) from 10 ms to 10 s are possible.
- Time measurement:
Relation conditions can be evaluated during time measurement. The result of the evaluation can be output via the process data or the digital output. This allows a controlled response when values exceed or fall below the limit values.
- Pulse generator:
The pulse generator generates square-wave signals with frequencies of 1 kHz to 10 kHz in 500 Hz increments.
- The event counting and frequency measurement modes yield a 24-bit measured value.
- The time measurement mode yields a 16-bit measured value.
- A combination of source and gate signal can be selected as a counter signal.
- During operation, a start value or final value can be changed without the counter having to be stopped.
- An RC filter can be connected to source and gate. This allows the use of mechanical switches.
- It is not necessary to send a counter start command to start the counting process. Counting starts immediately after the command for selecting the operating mode is transmitted.



For additional information on the terminal, such as a description of the process data and commands, as well as examples, please refer to the UM EN IB IL CNT-PAC user manual.

Компания «Life Electronics» занимается поставками электронных компонентов импортного и отечественного производства от производителей и со складов крупных дистрибьюторов Европы, Америки и Азии.

С конца 2013 года компания активно расширяет линейку поставок компонентов по направлению коаксиальный кабель, кварцевые генераторы и конденсаторы (керамические, пленочные, электролитические), за счёт заключения дистрибьюторских договоров

Мы предлагаем:

- Конкурентоспособные цены и скидки постоянным клиентам.
- Специальные условия для постоянных клиентов.
- Подбор аналогов.
- Поставку компонентов в любых объемах, удовлетворяющих вашим потребностям.
- Приемлемые сроки поставки, возможна ускоренная поставка.
- Доставку товара в любую точку России и стран СНГ.
- Комплексную поставку.
- Работу по проектам и поставку образцов.
- Формирование склада под заказчика.
- Сертификаты соответствия на поставляемую продукцию (по желанию клиента).
- Тестирование поставляемой продукции.
- Поставку компонентов, требующих военную и космическую приемку.
- Входной контроль качества.
- Наличие сертификата ISO.

В составе нашей компании организован Конструкторский отдел, призванный помогать разработчикам, и инженерам.

Конструкторский отдел помогает осуществить:

- Регистрацию проекта у производителя компонентов.
- Техническую поддержку проекта.
- Защиту от снятия компонента с производства.
- Оценку стоимости проекта по компонентам.
- Изготовление тестовой платы монтаж и пусконаладочные работы.



Тел: +7 (812) 336 43 04 (многоканальный)

Email: org@lifeelectronics.ru