

74LVC1G04

Single inverter

Rev. 15 — 8 June 2018

Product data sheet

1 General description

The 74LVC1G04 provides one inverting buffer.

Input can be driven from either 3.3 V or 5 V devices. These features allow the use of these devices in a mixed 3.3 V and 5 V environment.

Schmitt-trigger action at all inputs makes the circuit tolerant of slower input rise and fall time.

This device is fully specified for partial power-down applications using I_{OFF} . The I_{OFF} circuitry disables the output, preventing the damaging backflow current through the device when it is powered down.

2 Features and benefits

- Wide supply voltage range from 1.65 V to 5.5 V
- 5 V tolerant inputs for interfacing with 5 V logic
- High noise immunity
- Complies with JEDEC standard:
 - JESD8-7 (1.65 V to 1.95 V)
 - JESD8-5 (2.3 V to 2.7 V)
 - JESD8-B/JESD36 (2.7 V to 3.6 V)
- ESD protection:
 - HBM: ANSI/ESDA/JEDEC JS-001 Class 2 exceeds 2000 V
 - MM: JESD22-A115-A exceeds 200 V
- ± 24 mA output drive ($V_{CC} = 3.0$ V)
- CMOS low power consumption
- Latch-up performance exceeds 250 mA
- Direct interface with TTL levels
- Inputs accept voltages up to 5 V
- Multiple package options
- Specified from -40 °C to $+85$ °C and -40 °C to $+125$ °C.

3 Ordering information

Table 1. Ordering information

Type number	Package			Version
	Temperature range	Name	Description	
74LVC1G04GW	-40 °C to +125 °C	TSSOP5	plastic thin shrink small outline package; 5 leads; body width 1.25 mm	SOT353-1
74LVC1G04GV	-40 °C to +125 °C	SC-74A	plastic surface-mounted package; 5 leads	SOT753
74LVC1G04GM	-40 °C to +125 °C	XSON6	plastic extremely thin small outline package; no leads; 6 terminals; body 1 x 1.45 x 0.5 mm	SOT886
74LVC1G04GF	-40 °C to +125 °C	XSON6	plastic extremely thin small outline package; no leads; 6 terminals; body 1 x 1 x 0.5 mm	SOT891
74LVC1G04GN	-40 °C to +125 °C	XSON6	extremely thin small outline package; no leads; 6 terminals; body 0.9 x 1.0 x 0.35 mm	SOT1115
74LVC1G04GS	-40 °C to +125 °C	XSON6	extremely thin small outline package; no leads; 6 terminals; body 1.0 x 1.0 x 0.35 mm	SOT1202
74LVC1G04GX	-40 °C to +125 °C	X2SON5	plastic thermal enhanced extremely thin small outline package; no leads; 5 terminals; body 0.8 x 0.8 x 0.35 mm	SOT1226
74LVC1G04GX4	-40 °C to +125 °C	X2SON4	plastic thermal enhanced extremely thin small outline package; no leads; 4 terminals; body 0.6 x 0.6 x 0.32 mm	SOT1269-2

4 Marking

Table 2. Marking

Type number	Marking code ^[1]
74LVC1G04GW	VC
74LVC1G04GV	V04
74LVC1G04GM	VC
74LVC1G04GF	VC
74LVC1G04GN	VC
74LVC1G04GS	VC
74LVC1G04GX	VC
74LVC1G04GX4	VC

[1] The pin 1 indicator is located on the lower left corner of the device, below the marking code.

5 Functional diagram

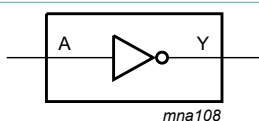

Figure 1. Logic symbol

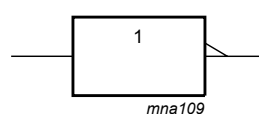

Figure 2. IEC logic symbol

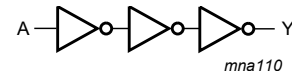

Figure 3. Logic diagram

6 Pinning information

6.1 Pinning

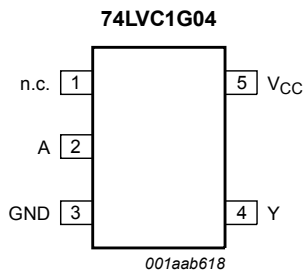

Figure 4. Pin configuration SOT353-1 and SOT753

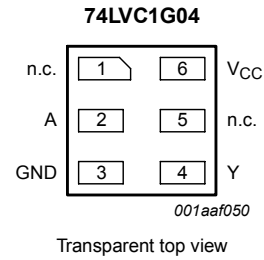

Figure 5. Pin configuration SOT886, SOT891, SOT1115 and SOT1202 (XSON6)

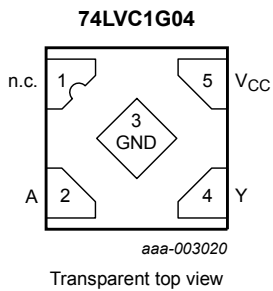

Figure 6. Pin configuration SOT1226 (X2SON5)

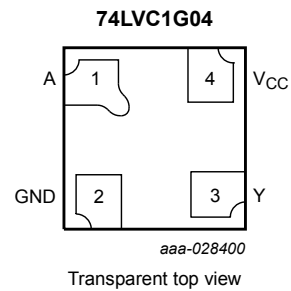

Figure 7. Pin configuration SOT1269-2 (X2SON4)

6.2 Pin description

Table 3. Pin description

Symbol	Pin			Description
	TSSOP5, SC-74A and X2SON5	XSON6	X2SON4	
n.c.	1	1, 5	-	not connected
A	2	2	1	data input
GND	3	3	2	ground (0 V)
Y	4	4	3	data output
V _{CC}	5	6	4	supply voltage

7 Functional description

Table 4. Function table

H = HIGH voltage level; L = LOW voltage level

Input	Output
A	Y
L	H
H	L

8 Limiting values

Table 5. Limiting values

In accordance with the Absolute Maximum Rating System (IEC 60134). Voltages are referenced to GND (ground = 0 V).

Symbol	Parameter	Conditions	Min	Max	Unit
V_{CC}	supply voltage		-0.5	+6.5	V
I_{IK}	input clamping current	$V_I < 0$ V	-50	-	mA
V_I	input voltage	[1]	-0.5	+6.5	V
I_{OK}	output clamping current	$V_O > V_{CC}$ or $V_O < 0$ V	-	± 50	mA
V_O	output voltage	Active mode [1]	-0.5	$V_{CC} + 0.5$	V
		Power-down mode; $V_{CC} = 0$ V [1]	-0.5	+6.5	V
I_O	output current	$V_O = 0$ to V_{CC}	-	± 50	mA
I_{CC}	supply current		-	100	mA
I_{GND}	ground current		-100	-	mA
T_{stg}	storage temperature		-65	+150	°C
P_{tot}	total power dissipation	$T_{amb} = -40$ °C to $+125$ °C			
		TSSOP5, SC-74A, XSON6 and X2SON5 package [2]	-	250	mW
		X2SON4 package [3]	-	150	mW

[1] The input and output voltage ratings may be exceeded if the input and output current ratings are observed.

[2] For TSSOP5 and SC-74A packages: above 87.5 °C the value of P_{tot} derates linearly with 4.0 mW/K.

For XSON6 and X2SON5 package: above 118 °C the value of P_{tot} derates linearly with 7.8 mW/K.

[3] For X2SON4 packages: above 57 °C the value of P_{tot} derates linearly with 1.7 mW/K.

9 Recommended operating conditions

Table 6. Recommended operating conditions

Symbol	Parameter	Conditions	Min	Typ	Max	Unit
V_{CC}	supply voltage		1.65	-	5.5	V
V_I	input voltage		0	-	5.5	V
V_O	output voltage	Active mode	0	-	V_{CC}	V_O
		Power-down mode; $V_{CC} = 0$ V	0	-	5.5	V_O
T_{amb}	ambient temperature		-40	-	+125	°C
$\Delta t/\Delta V$	input transition rise and fall rate	$V_{CC} = 1.65$ V to 2.7 V	-	-	20	ns/V
		$V_{CC} = 2.7$ V to 5.5 V	-	-	10	ns/V

10 Static characteristics

Table 7. Static characteristics

At recommended operating conditions. Voltages are referenced to GND (ground = 0 V).

Symbol	Parameter	Conditions	Min	Typ ^[1]	Max	Unit
T_{amb} = -40 °C to +85 °C						
V _{IH}	HIGH-level input voltage	V _{CC} = 1.65 V to 1.95 V	0.65 × V _{CC}	-	-	V
		V _{CC} = 2.3 V to 2.7 V	1.7	-	-	V
		V _{CC} = 2.7 V to 3.6 V	2.0	-	-	V
		V _{CC} = 4.5 V to 5.5 V	0.7 × V _{CC}	-	-	V
V _{IL}	LOW-level input voltage	V _{CC} = 1.65 V to 1.95 V	-	-	0.35 × V _{CC}	V
		V _{CC} = 2.3 V to 2.7 V	-	-	0.7	V
		V _{CC} = 2.7 V to 3.6 V	-	-	0.8	V
		V _{CC} = 4.5 V to 5.5 V	-	-	0.3 × V _{CC}	V
V _{OH}	HIGH-level output voltage	V _I = V _{IH} or V _{IL}				
		I _O = -100 μA; V _{CC} = 1.65 V to 5.5 V	V _{CC} - 0.1	-	-	V
		I _O = -4 mA; V _{CC} = 1.65 V	1.2	-	-	V
		I _O = -8 mA; V _{CC} = 2.3 V	1.9	-	-	V
		I _O = -12 mA; V _{CC} = 2.7 V	2.2	-	-	V
		I _O = -24 mA; V _{CC} = 3.0 V	2.3	-	-	V
		I _O = -32 mA; V _{CC} = 4.5 V	3.8	-	-	V
V _{OL}	LOW-level output voltage	V _I = V _{IH} or V _{IL}				
		I _O = 100 μA; V _{CC} = 1.65 V to 5.5 V	-	-	0.1	V
		I _O = 4 mA; V _{CC} = 1.65 V	-	-	0.45	V
		I _O = 8 mA; V _{CC} = 2.3 V	-	-	0.3	V
		I _O = 12 mA; V _{CC} = 2.7 V	-	-	0.4	V
		I _O = 24 mA; V _{CC} = 3.0 V	-	-	0.55	V
		I _O = 32 mA; V _{CC} = 4.5 V	-	-	0.55	V
I _I	input leakage current	V _{CC} = 0 V to 5.5 V; V _I = 5.5 V or GND	-	±0.1	±1	μA
I _{OFF}	power-off leakage current	V _{CC} = 0 V; V _I or V _O = 5.5 V	-	±0.1	±2	μA
I _{CC}	supply current	V _I = 5.5 V or GND; V _{CC} = 1.65 V to 5.5 V; I _O = 0 A	-	0.1	4	μA
ΔI _{CC}	additional supply current	per pin; V _{CC} = 2.3 V to 5.5 V; V _I = V _{CC} - 0.6 V; I _O = 0 A	-	5	500	μA
C _I	input capacitance	V _{CC} = 3.3 V; V _I = GND to V _{CC}	-	5	-	pF

Symbol	Parameter	Conditions	Min	Typ ^[1]	Max	Unit
T_{amb} = -40 °C to +125 °C						
V _{IH}	HIGH-level input voltage	V _{CC} = 1.65 V to 1.95 V	0.65 × V _{CC}	-	-	V
		V _{CC} = 2.3 V to 2.7 V	1.7	-	-	V
		V _{CC} = 2.7 V to 3.6 V	2.0	-	-	V
		V _{CC} = 4.5 V to 5.5 V	0.7 × V _{CC}	-	-	V
V _{IL}	LOW-level input voltage	V _{CC} = 1.65 V to 1.95 V	-	-	0.35 × V _{CC}	V
		V _{CC} = 2.3 V to 2.7 V	-	-	0.7	V
		V _{CC} = 2.7 V to 3.6 V	-	-	0.8	V
		V _{CC} = 4.5 V to 5.5 V	-	-	0.3 × V _{CC}	V
V _{OH}	HIGH-level output voltage	V _I = V _{IH} or V _{IL}				
		I _O = -100 μA; V _{CC} = 1.65 V to 5.5 V	V _{CC} - 0.1	-	-	V
		I _O = -4 mA; V _{CC} = 1.65 V	0.95	-	-	V
		I _O = -8 mA; V _{CC} = 2.3 V	1.7	-	-	V
		I _O = -12 mA; V _{CC} = 2.7 V	1.9	-	-	V
		I _O = -24 mA; V _{CC} = 3.0 V	2.0	-	-	V
		I _O = -32 mA; V _{CC} = 4.5 V	3.4	-	-	V
V _{OL}	LOW-level output voltage	V _I = V _{IH} or V _{IL}				
		I _O = 100 μA; V _{CC} = 1.65 V to 5.5 V	-	-	0.1	V
		I _O = 4 mA; V _{CC} = 1.65 V	-	-	0.70	V
		I _O = 8 mA; V _{CC} = 2.3 V	-	-	0.45	V
		I _O = 12 mA; V _{CC} = 2.7 V	-	-	0.60	V
		I _O = 24 mA; V _{CC} = 3.0 V	-	-	0.80	V
		I _O = 32 mA; V _{CC} = 4.5 V	-	-	0.80	V
I _I	input leakage current	V _{CC} = 0 V to 5.5 V; V _I = 5.5 V or GND	-	-	±1	μA
I _{OFF}	power-off leakage current	V _{CC} = 0 V; V _I or V _O = 5.5 V	-	-	±2	μA
I _{CC}	supply current	V _I = 5.5 V or GND; V _{CC} = 1.65 V to 5.5 V; I _O = 0 A	-	-	4	μA
ΔI _{CC}	additional supply current	per pin; V _{CC} = 2.3 V to 5.5 V; V _I = V _{CC} - 0.6 V; I _O = 0 A	-	-	500	μA

[1] All typical values are measured at V_{CC} = 3.3 V and T_{amb} = 25 °C.

11 Dynamic characteristics

Table 8. Dynamic characteristics

Voltages are referenced to GND (ground = 0 V). For test circuit see [Figure 9](#).

Symbol	Parameter	Conditions	-40 °C to +85 °C			-40 °C to +125 °C		Unit
			Min	Typ ^[1]	Max	Min	Max	
t _{pd}	propagation delay	A to Y; see Figure 8 ^[2]						
		V _{CC} = 1.65 V to 1.95 V	1.0	3.0	7.5	1.0	9.5	ns
		V _{CC} = 2.3 V to 2.7 V	0.5	2.0	5.0	0.5	6.5	ns
		V _{CC} = 2.7 V	0.5	2.3	5.2	0.5	7.0	ns
		V _{CC} = 3.0 V to 3.6 V	0.5	2.0	4.2	0.5	5.5	ns
		V _{CC} = 4.5 V to 5.5 V	0.5	1.6	3.7	0.5	5.0	ns
C _{PD}	power dissipation capacitance	V _I = GND to V _{CC} ; V _{CC} = 3.3 V ^[3]	-	14	-	-	-	pF

[1] Typical values are measured at T_{amb} = 25 °C and V_{CC} = 1.8 V, 2.5 V, 2.7 V, 3.3 V and 5.0 V respectively.

[2] t_{pd} is the same as t_{PLH} and t_{PHL}.

[3] C_{PD} is used to determine the dynamic power dissipation (P_D in μW).

$$P_D = C_{PD} \times V_{CC}^2 \times f_i \times N + \sum(C_L \times V_{CC}^2 \times f_o) \text{ where:}$$

f_i = input frequency in MHz;

f_o = output frequency in MHz;

C_L = output load capacitance in pF;

V_{CC} = supply voltage in V;

N = number of inputs switching;

∑(C_L × V_{CC}² × f_o) = sum of outputs.

11.1 Waveform and test circuit

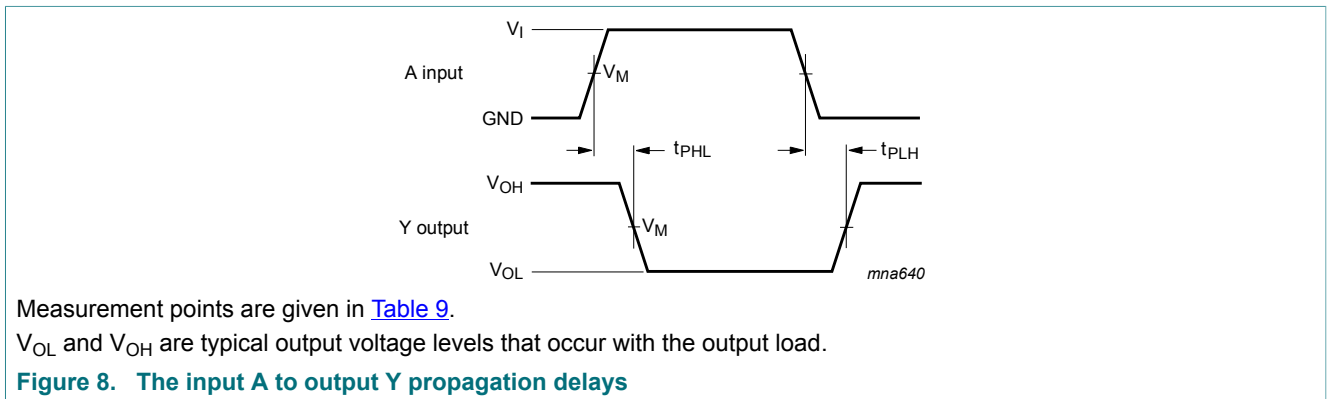
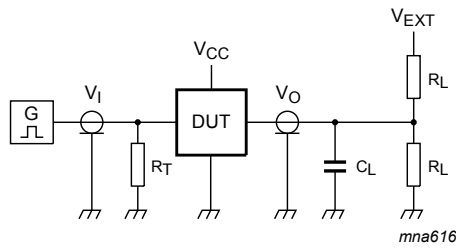

Table 9. Measurement points

Supply voltage	Input	Output
V_{CC}	V_M	V_M
1.65 V to 1.95 V	$0.5 \times V_{CC}$	$0.5 \times V_{CC}$
2.3 V to 2.7 V	$0.5 \times V_{CC}$	$0.5 \times V_{CC}$
2.7 V	1.5 V	1.5 V
3.0 V to 3.6 V	1.5 V	1.5 V
4.5 V to 5.5 V	$0.5 \times V_{CC}$	$0.5 \times V_{CC}$



Test data is given in [Table 10](#).

Definitions for test circuit:

R_L = Load resistance.

C_L = Load capacitance including jig and probe capacitance.

R_T = Termination resistance should be equal to the output impedance Z_o of the pulse generator.

V_{EXT} = External voltage for measuring switching times.

Figure 9. Test circuit for measuring switching times

Table 10. Test data

Supply voltage	Input	Load			V_{EXT}
V_{CC}	V_I	$t_r = t_f$	C_L	R_L	t_{PLH}, t_{PHL}
1.65 V to 1.95 V	V_{CC}	≤ 2.0 ns	30 pF	1 k Ω	open
2.3 V to 2.7 V	V_{CC}	≤ 2.0 ns	30 pF	500 Ω	open
2.7 V	2.7 V	≤ 2.5 ns	50 pF	500 Ω	open
3.0 V to 3.6 V	2.7 V	≤ 2.5 ns	50 pF	500 Ω	open
4.5 V to 5.5 V	V_{CC}	≤ 2.5 ns	50 pF	500 Ω	open

12 Package outline

TSSOP5: plastic thin shrink small outline package; 5 leads; body width 1.25 mm

SOT353-1

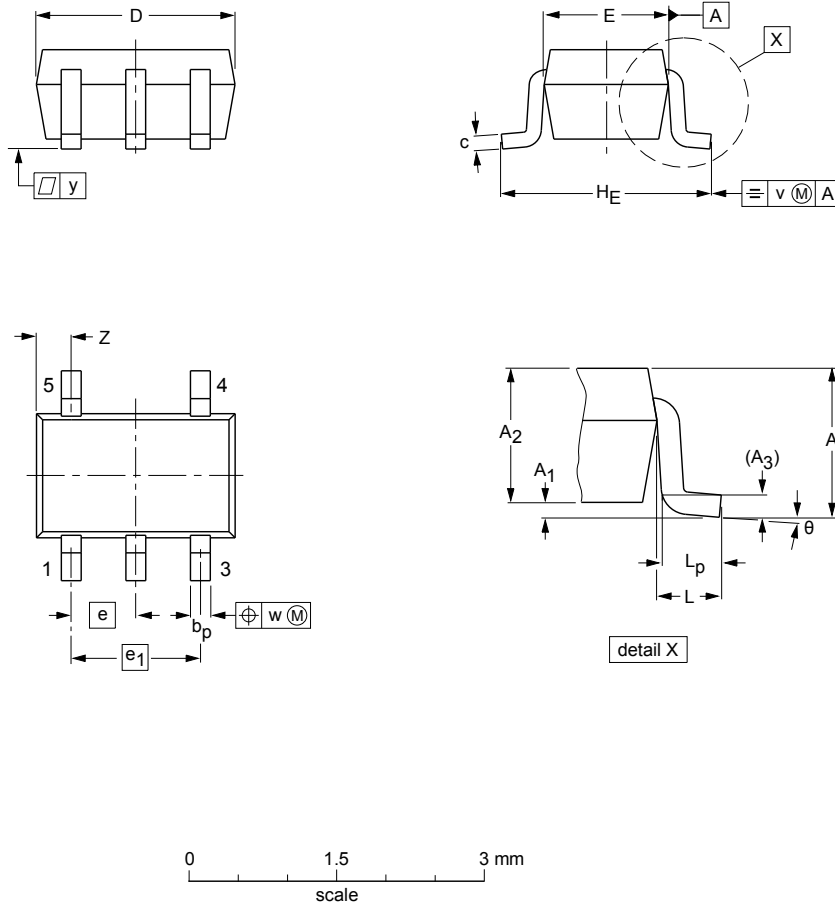

DIMENSIONS (mm are the original dimensions)

UNIT	A max.	A ₁	A ₂	A ₃	b _p	c	D ⁽¹⁾	E ⁽¹⁾	e	e ₁	H _E	L	L _p	v	w	y	Z ⁽¹⁾	θ
mm	1.1	0.1 0	1.0 0.8	0.15	0.30 0.15	0.25 0.08	2.25 1.85	1.35 1.15	0.65	1.3	2.25 2.0	0.425	0.46 0.21	0.3	0.1	0.1	0.60 0.15	7° 0°

Note

1. Plastic or metal protrusions of 0.15 mm maximum per side are not included.

OUTLINE VERSION	REFERENCES			EUROPEAN PROJECTION	ISSUE DATE
	IEC	JEDEC	JEITA		
SOT353-1		MO-203	SC-88A		00-09-01 03-02-19

Figure 10. Package outline SOT353-1 (TSSOP5)

Plastic surface-mounted package; 5 leads

SOT753

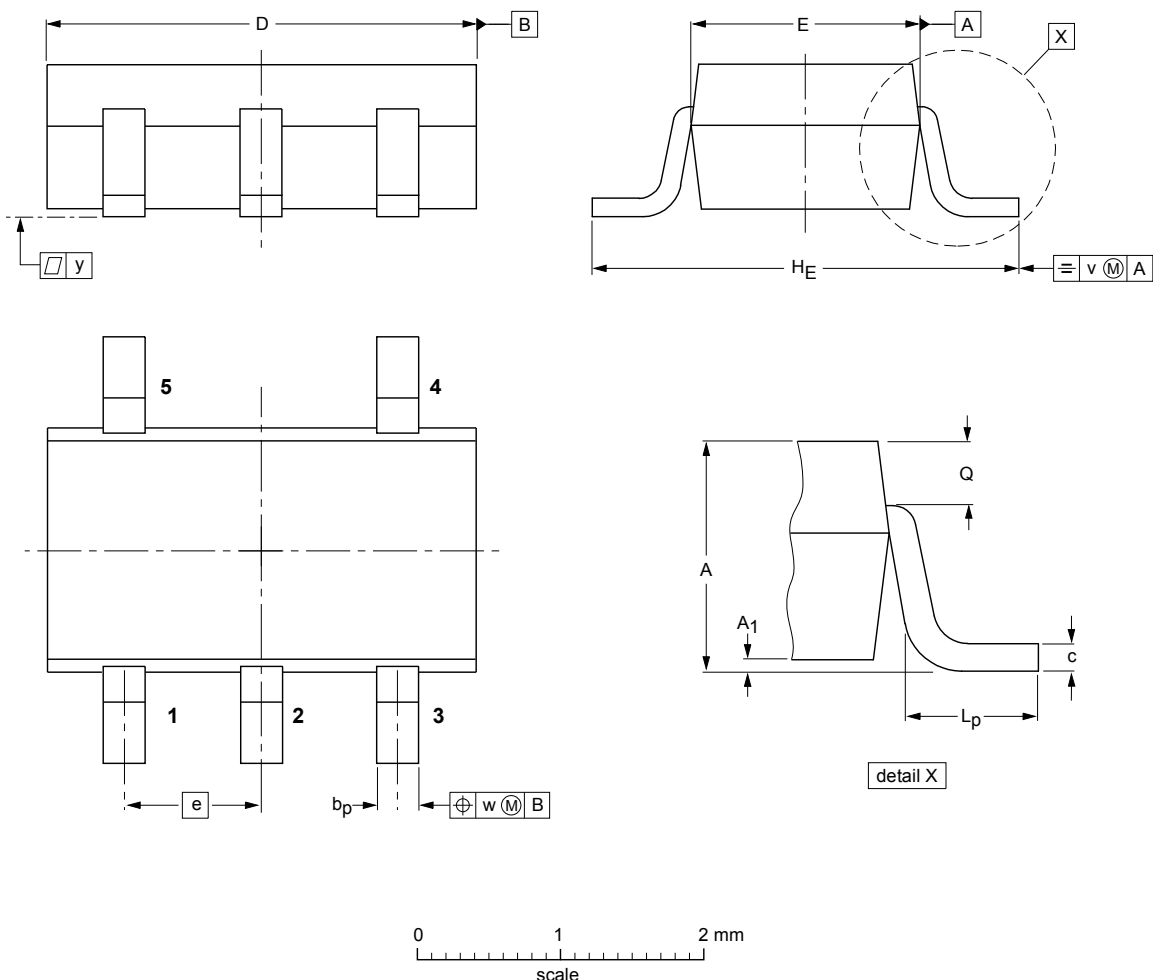

DIMENSIONS (mm are the original dimensions)

UNIT	A	A ₁	b _p	c	D	E	e	H _E	L _p	Q	v	w	y
mm	1.1 0.9	0.100 0.013	0.40 0.25	0.26 0.10	3.1 2.7	1.7 1.3	0.95	3.0 2.5	0.6 0.2	0.33 0.23	0.2	0.2	0.1

OUTLINE VERSION	REFERENCES			EUROPEAN PROJECTION	ISSUE DATE
	IEC	JEDEC	JEITA		
SOT753			SC-74A		02-04-16 06-03-16

Figure 11. Package outline SOT753 (SC-74A)

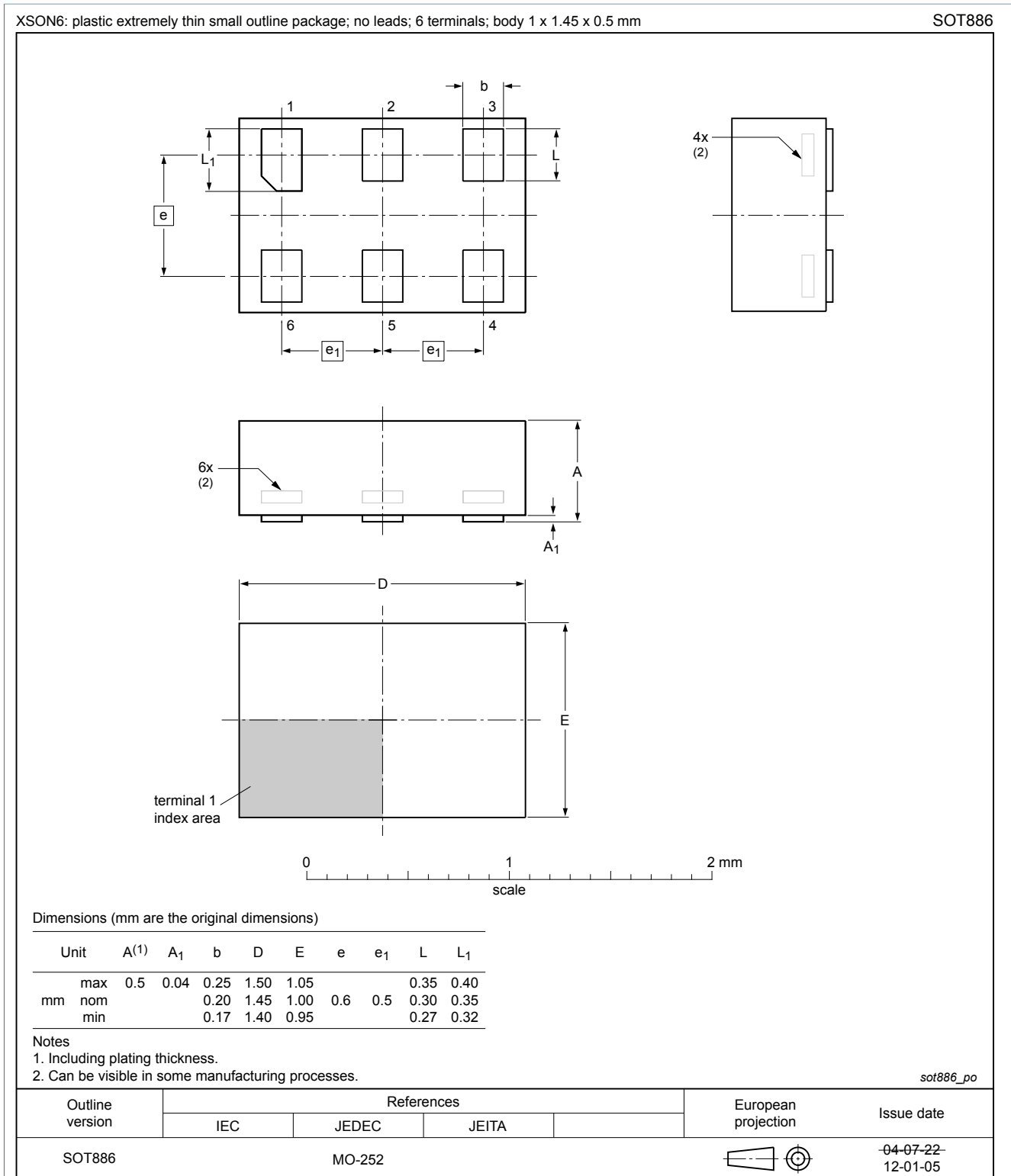
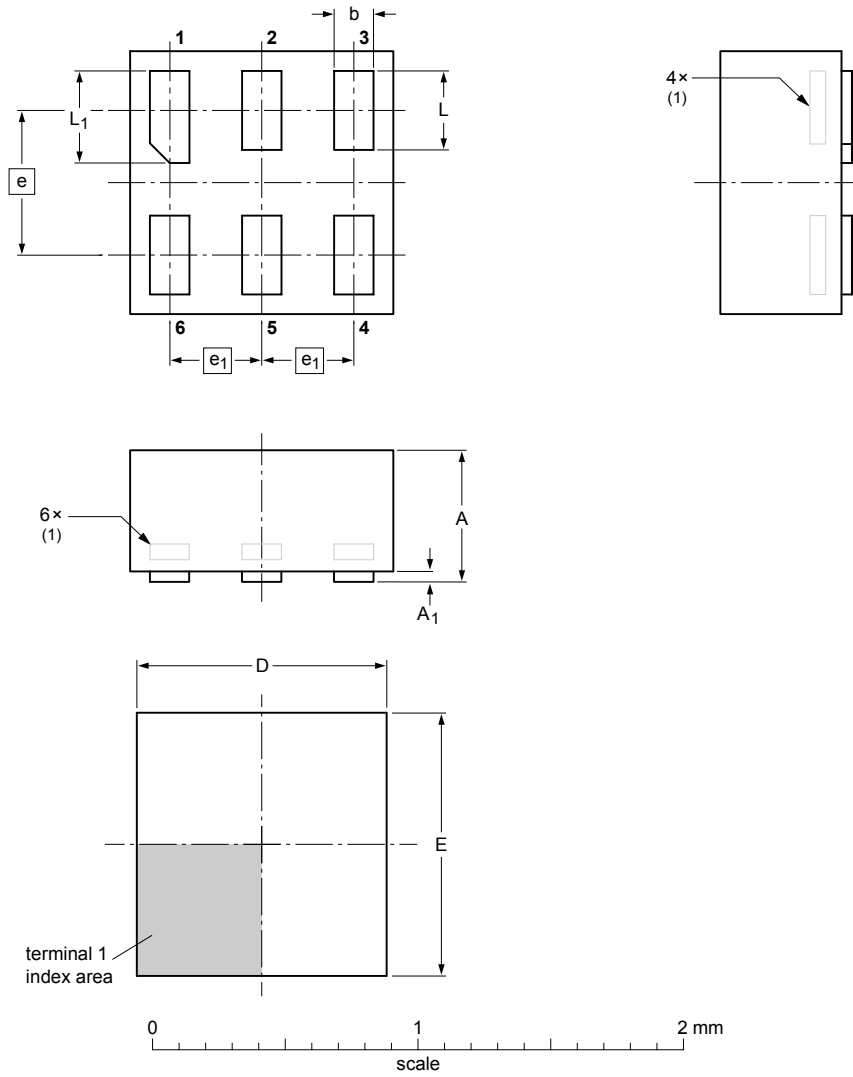

Figure 12. Package outline SOT886 (XSON6)

XSON6: plastic extremely thin small outline package; no leads; 6 terminals; body 1 x 1 x 0.5 mm

SOT891



DIMENSIONS (mm are the original dimensions)

UNIT	A max	A ₁ max	b	D	E	e	e ₁	L	L ₁
mm	0.5	0.04	0.20 0.12	1.05 0.95	1.05 0.95	0.55	0.35	0.35 0.27	0.40 0.32

Note

1. Can be visible in some manufacturing processes.

OUTLINE VERSION	REFERENCES			EUROPEAN PROJECTION	ISSUE DATE
	IEC	JEDEC	JEITA		
SOT891					-05-04-06 07-05-15

Figure 13. Package outline SOT891 (XSON6)

XSON6: extremely thin small outline package; no leads;
6 terminals; body 0.9 x 1.0 x 0.35 mm

SOT1115

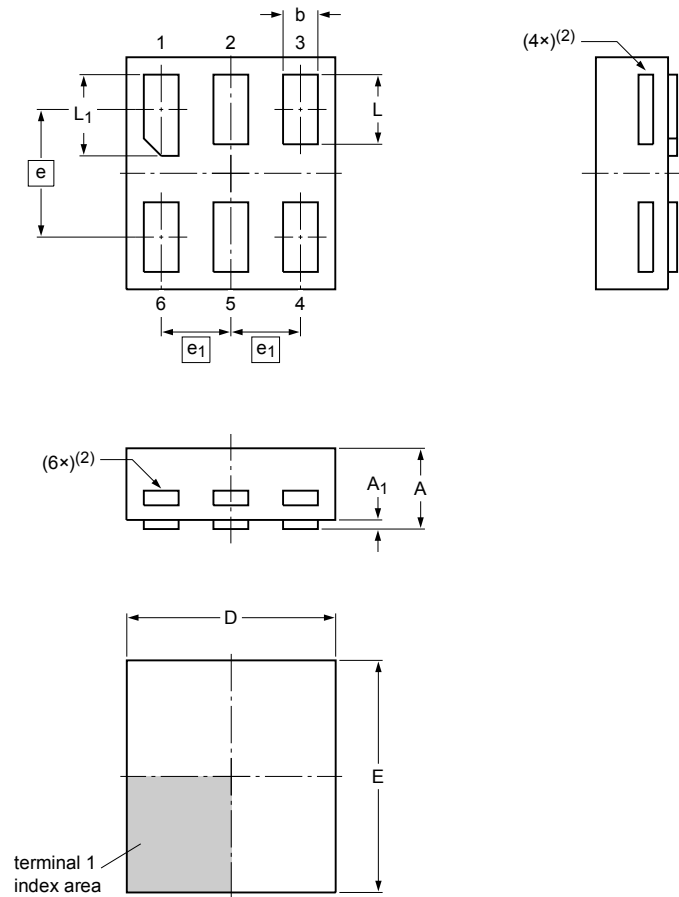

Dimensions

Unit	A ⁽¹⁾	A ₁	b	D	E	e	e ₁	L	L ₁
mm	max 0.35	0.04	0.20	0.95	1.05			0.35	0.40
	nom 0.15		0.90	1.00	0.55	0.3		0.30	0.35
	min 0.12		0.85	0.95				0.27	0.32

Note

- Including plating thickness.
- Visible depending upon used manufacturing technology.

sot1115_po

Outline version	References				European projection	Issue date
	IEC	JEDEC	JEITA			
SOT1115						-10-04-02- 10-04-07

Figure 14. Package outline SOT1115 (XSON6)

**XSON6: extremely thin small outline package; no leads;
6 terminals; body 1.0 x 1.0 x 0.35 mm**

SOT1202

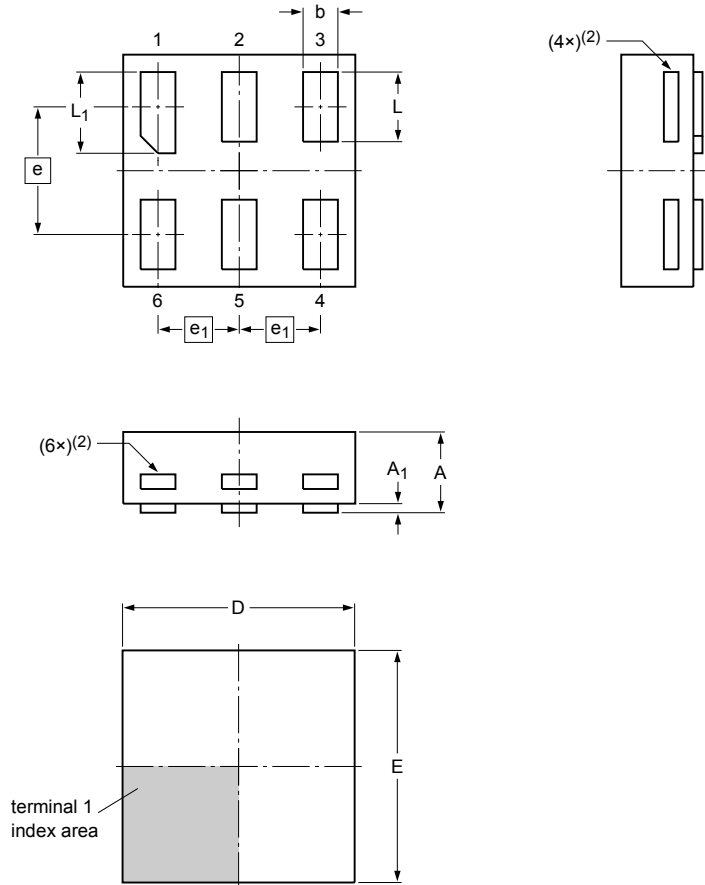

Dimensions

Unit	A ⁽¹⁾	A ₁	b	D	E	e	e ₁	L	L ₁
mm	max 0.35	0.04	0.20	1.05	1.05	0.35	0.30	0.35	0.40
	nom 0.15	1.00	1.00	0.55	0.35	0.30	0.35		
	min 0.12	0.95	0.95			0.27	0.32		

Note

- Including plating thickness.
- Visible depending upon used manufacturing technology.

sot1202_po

Outline version	References				European projection	Issue date
	IEC	JEDEC	JEITA			
SOT1202						-10-04-02- 10-04-06

Figure 15. Package outline SOT1202 (XSON6)

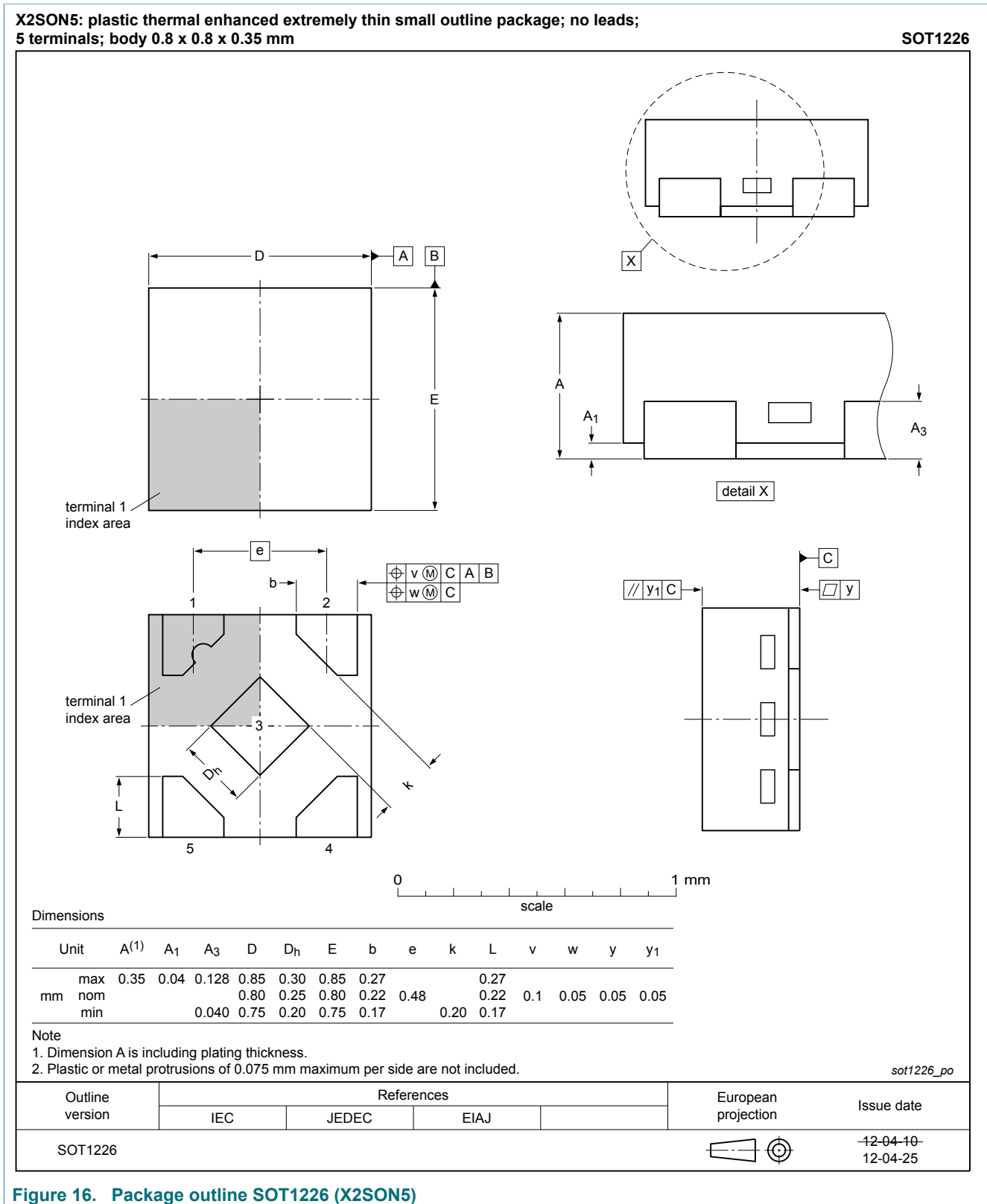

Figure 16. Package outline SOT1226 (X2SON5)

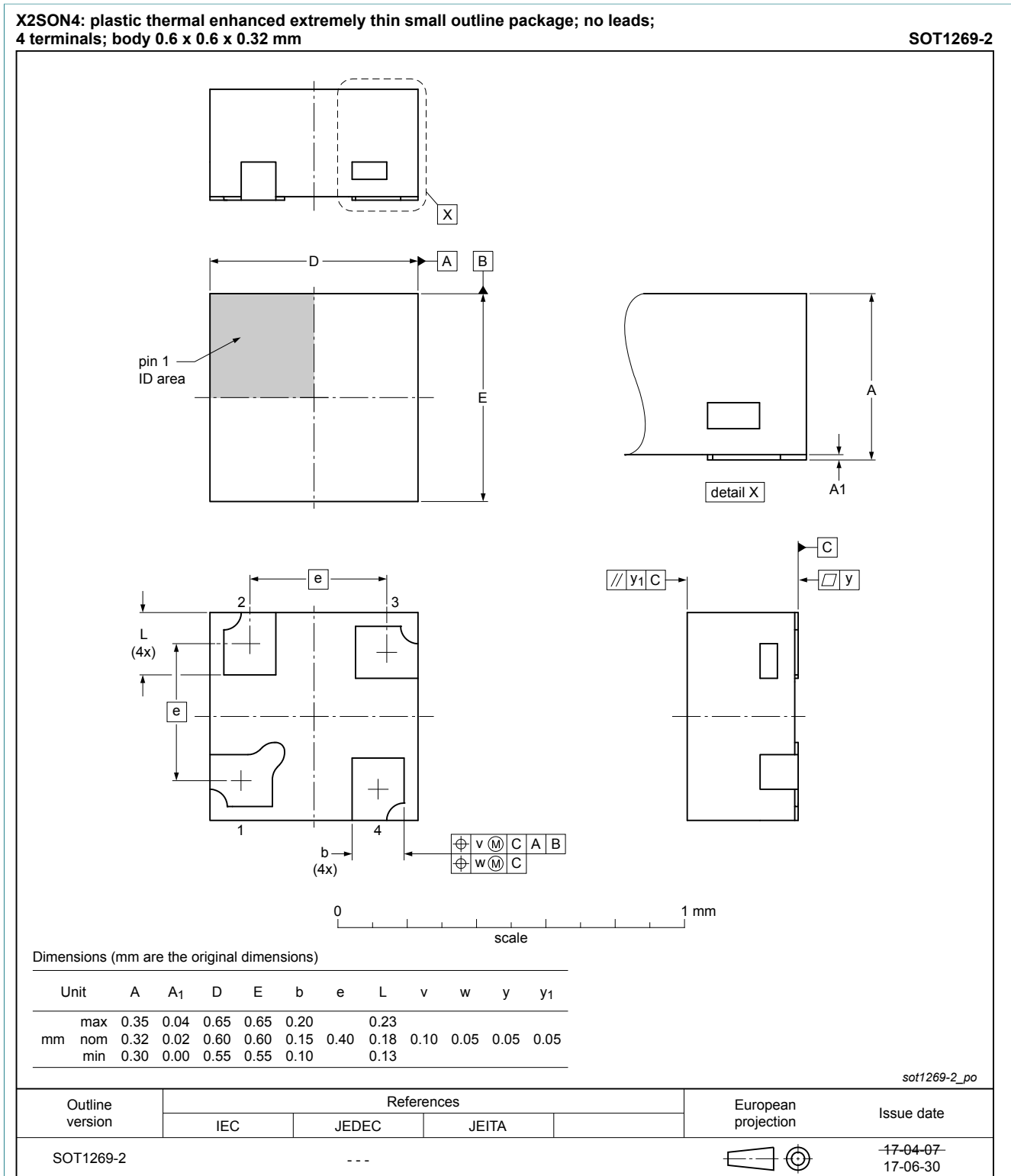

Figure 17. Package outline SOT1269-2 (X2SON4)

13 Abbreviations

Table 11. Abbreviations

Acronym	Description
CMOS	Complementary Metal Oxide Semiconductor
DUT	Device Under Test
ESD	ElectroStatic Discharge
HBM	Human Body Model
MM	Machine Model
TTL	Transistor-Transistor Logic

14 Revision history

Table 12. Revision history

Document ID	Release date	Data sheet status	Change notice	Supersedes
74LVC1G04 v.15	20180608	Product data sheet	-	74LVC1G04 v.14
Modifications:	<ul style="list-style-type: none"> Added type number 74LVC1G04GX4 (SOT1269-2) 			
74LVC1G04 v.14	20171101	Product data sheet	-	74LVC1G04 v.13
Modifications:	<ul style="list-style-type: none"> The format of this data sheet has been redesigned to comply with the identity guidelines of Nexperia. Legal texts have been adapted to the new company name where appropriate. 			
74LVC1G04 v.13	20161128	Product data sheet	-	74LVC1G04 v.12
Modifications:	<ul style="list-style-type: none"> Table 7: The maximum limits for leakage current and supply current have changed. 			
74LVC1G04 v.12	20120806	Product data sheet	-	74LVC1G04 v.11
Modifications:	<ul style="list-style-type: none"> Package outline drawing of SOT1226 (Figure 16) modified. 			
74LVC1G04 v.11	20120412	Product data sheet	-	74LVC1G04 v.10
Modifications:	<ul style="list-style-type: none"> Added type number 74LVC1G04GX (SOT1226) Package outline drawing of SOT886 (Figure 12) modified. 			
74LVC1G04 v.10	20111207	Product data sheet	-	74LVC1G04 v.9
Modifications:	<ul style="list-style-type: none"> Legal pages updated. 			
74LVC1G04 v.9	20101026	Product data sheet	-	74LVC1G04 v.8
74LVC1G04 v.8	20090427	Product data sheet	-	74LVC1G04 v.7
74LVC1G04 v.7	20070827	Product data sheet	-	74LVC1G04 v.6
74LVC1G04 v.6	20070202	Product data sheet	-	74LVC1G04 v.5
74LVC1G04 v.5	20040907	Product specification	-	74LVC1G04 v.4
74LVC1G04 v.4	20021002	Product specification	-	74LVC1G04 v.3
74LVC1G04 v.3	20020513	Product specification	-	74LVC1G04 v.2
74LVC1G04 v.2	20010119	Product specification	-	74LVC1G04 v.1
74LVC1G04 v.1	20011121	Product specification	-	-

15 Legal information

15.1 Data sheet status

Document status ^{[1][2]}	Product status ^[3]	Definition
Objective [short] data sheet	Development	This document contains data from the objective specification for product development.
Preliminary [short] data sheet	Qualification	This document contains data from the preliminary specification.
Product [short] data sheet	Production	This document contains the product specification.

[1] Please consult the most recently issued document before initiating or completing a design.

[2] The term 'short data sheet' is explained in section "Definitions".

[3] The product status of device(s) described in this document may have changed since this document was published and may differ in case of multiple devices. The latest product status information is available on the Internet at URL <http://www.nexperia.com>.

15.2 Definitions

Draft — The document is a draft version only. The content is still under internal review and subject to formal approval, which may result in modifications or additions. Nexperia does not give any representations or warranties as to the accuracy or completeness of information included herein and shall have no liability for the consequences of use of such information.

Short data sheet — A short data sheet is an extract from a full data sheet with the same product type number(s) and title. A short data sheet is intended for quick reference only and should not be relied upon to contain detailed and full information. For detailed and full information see the relevant full data sheet, which is available on request via the local Nexperia sales office. In case of any inconsistency or conflict with the short data sheet, the full data sheet shall prevail.

Product specification — The information and data provided in a Product data sheet shall define the specification of the product as agreed between Nexperia and its customer, unless Nexperia and customer have explicitly agreed otherwise in writing. In no event however, shall an agreement be valid in which the Nexperia product is deemed to offer functions and qualities beyond those described in the Product data sheet.

15.3 Disclaimers

Limited warranty and liability — Information in this document is believed to be accurate and reliable. However, Nexperia does not give any representations or warranties, expressed or implied, as to the accuracy or completeness of such information and shall have no liability for the consequences of use of such information. Nexperia takes no responsibility for the content in this document if provided by an information source outside of Nexperia. In no event shall Nexperia be liable for any indirect, incidental, punitive, special or consequential damages (including - without limitation - lost profits, lost savings, business interruption, costs related to the removal or replacement of any products or rework charges) whether or not such damages are based on tort (including negligence), warranty, breach of contract or any other legal theory. Notwithstanding any damages that customer might incur for any reason whatsoever, Nexperia's aggregate and cumulative liability towards customer for the products described herein shall be limited in accordance with the Terms and conditions of commercial sale of Nexperia.

Right to make changes — Nexperia reserves the right to make changes to information published in this document, including without limitation specifications and product descriptions, at any time and without notice. This document supersedes and replaces all information supplied prior to the publication hereof.

Suitability for use — Nexperia products are not designed, authorized or warranted to be suitable for use in life support, life-critical or safety-critical

systems or equipment, nor in applications where failure or malfunction of an Nexperia product can reasonably be expected to result in personal injury, death or severe property or environmental damage. Nexperia and its suppliers accept no liability for inclusion and/or use of Nexperia products in such equipment or applications and therefore such inclusion and/or use is at the customer's own risk.

Applications — Applications that are described herein for any of these products are for illustrative purposes only. Nexperia makes no representation or warranty that such applications will be suitable for the specified use without further testing or modification. Customers are responsible for the design and operation of their applications and products using Nexperia products, and Nexperia accepts no liability for any assistance with applications or customer product design. It is customer's sole responsibility to determine whether the Nexperia product is suitable and fit for the customer's applications and products planned, as well as for the planned application and use of customer's third party customer(s). Customers should provide appropriate design and operating safeguards to minimize the risks associated with their applications and products. Nexperia does not accept any liability related to any default, damage, costs or problem which is based on any weakness or default in the customer's applications or products, or the application or use by customer's third party customer(s). Customer is responsible for doing all necessary testing for the customer's applications and products using Nexperia products in order to avoid a default of the applications and the products or of the application or use by customer's third party customer(s). Nexperia does not accept any liability in this respect.

Limiting values — Stress above one or more limiting values (as defined in the Absolute Maximum Ratings System of IEC 60134) will cause permanent damage to the device. Limiting values are stress ratings only and (proper) operation of the device at these or any other conditions above those given in the Recommended operating conditions section (if present) or the Characteristics sections of this document is not warranted. Constant or repeated exposure to limiting values will permanently and irreversibly affect the quality and reliability of the device.

Terms and conditions of commercial sale — Nexperia products are sold subject to the general terms and conditions of commercial sale, as published at <http://www.nexperia.com/profile/terms>, unless otherwise agreed in a valid written individual agreement. In case an individual agreement is concluded only the terms and conditions of the respective agreement shall apply. Nexperia hereby expressly objects to applying the customer's general terms and conditions with regard to the purchase of Nexperia products by customer.

No offer to sell or license — Nothing in this document may be interpreted or construed as an offer to sell products that is open for acceptance or the grant, conveyance or implication of any license under any copyrights, patents or other industrial or intellectual property rights.

Export control — This document as well as the item(s) described herein may be subject to export control regulations. Export might require a prior authorization from competent authorities.

Non-automotive qualified products — Unless this data sheet expressly states that this specific Nexperia product is automotive qualified, the product is not suitable for automotive use. It is neither qualified nor tested in accordance with automotive testing or application requirements. Nexperia accepts no liability for inclusion and/or use of non-automotive qualified products in automotive equipment or applications. In the event that customer uses the product for design-in and use in automotive applications to automotive specifications and standards, customer (a) shall use the product without Nexperia's warranty of the product for such automotive applications, use and specifications, and (b) whenever customer uses the product for automotive applications beyond Nexperia's specifications such use shall be solely at customer's own risk, and (c) customer fully indemnifies Nexperia for any liability, damages or failed product claims resulting from customer

design and use of the product for automotive applications beyond Nexperia's standard warranty and Nexperia's product specifications.

Translations — A non-English (translated) version of a document is for reference only. The English version shall prevail in case of any discrepancy between the translated and English versions.

15.4 Trademarks

Notice: All referenced brands, product names, service names and trademarks are the property of their respective owners.

Contents

1	General description	1
2	Features and benefits	1
3	Ordering information	2
4	Marking	2
5	Functional diagram	2
6	Pinning information	3
6.1	Pinning	3
6.2	Pin description	3
7	Functional description	4
8	Limiting values	4
9	Recommended operating conditions	5
10	Static characteristics	6
11	Dynamic characteristics	8
11.1	Waveform and test circuit	8
12	Package outline	10
13	Abbreviations	18
14	Revision history	18
15	Legal information	19

Please be aware that important notices concerning this document and the product(s) described herein, have been included in section 'Legal information'.

© Nexperia B.V. 2018.

All rights reserved.

For more information, please visit: <http://www.nexperia.com>

For sales office addresses, please send an email to: salesaddresses@nexperia.com

Date of release: 8 June 2018
Document identifier: 74LVC1G04

Компания «Life Electronics» занимается поставками электронных компонентов импортного и отечественного производства от производителей и со складов крупных дистрибьюторов Европы, Америки и Азии.

С конца 2013 года компания активно расширяет линейку поставок компонентов по направлению коаксиальный кабель, кварцевые генераторы и конденсаторы (керамические, пленочные, электролитические), за счёт заключения дистрибьюторских договоров

Мы предлагаем:

- Конкурентоспособные цены и скидки постоянным клиентам.
- Специальные условия для постоянных клиентов.
- Подбор аналогов.
- Поставку компонентов в любых объемах, удовлетворяющих вашим потребностям.
- Приемлемые сроки поставки, возможна ускоренная поставка.
- Доставку товара в любую точку России и стран СНГ.
- Комплексную поставку.
- Работу по проектам и поставку образцов.
- Формирование склада под заказчика.
- Сертификаты соответствия на поставляемую продукцию (по желанию клиента).
- Тестирование поставляемой продукции.
- Поставку компонентов, требующих военную и космическую приемку.
- Входной контроль качества.
- Наличие сертификата ISO.

В составе нашей компании организован Конструкторский отдел, призванный помогать разработчикам, и инженерам.

Конструкторский отдел помогает осуществить:

- Регистрацию проекта у производителя компонентов.
- Техническую поддержку проекта.
- Защиту от снятия компонента с производства.
- Оценку стоимости проекта по компонентам.
- Изготовление тестовой платы монтаж и пусконаладочные работы.



Тел: +7 (812) 336 43 04 (многоканальный)

Email: org@lifeelectronics.ru