

\*RoHS COMPLIANT



**BOURNS®**

**Features**

- Surface Mount / Single Turn / Cermet Industrial / Sealed
- Compatible with surface mount manufacturing processes
- Compatible with popular vacuum pick-and-place equipment
- J-hook, gull-wing and pinned configurations

- Side adjust available
- Meets EIA/EIAJ/IPC/VECI SMD standard trimmer designs
- RoHS compliant\* - see [processing information](#) on lead free surface mount trimmers
- For trimmer applications/processing guidelines, [click here](#)

**3314 - 4 mm Square Timpot® Trimming Potentiometer**

**Electrical Characteristics**

Standard Resistance Range ..... 10 ohms to 2 megohms (see standard resistance table)  
 Resistance Tolerance ..... ±20 % std. (tighter tolerance available)  
 End Resistance ..... 1 % or 2 ohms max. (whichever is greater)  
 Contact Resistance Variation ..... 3 % or 3 ohms  
 Resolution ..... Infinite  
 Insulation Resistance ..... 500 vdc. 100 megohms min.  
 Dielectric Strength  
 Sea Level ..... 500 vac (1 minute)  
 Adjustment Angle ..... 210 ° nom.

**Environmental Characteristics**

Power Rating (300 volts max.)  
 70 °C ..... 0.25 watt  
 125 °C ..... 0 watt  
 Temperature Range ... -55 °C to +125 °C  
 Temperature Coefficient ... ±100 ppm/°C  
 Humidity ..... 90-98 % RH, 10 cycles, 240 hours  
 TRS ±2 %; IR 10 megohms  
 Vibration ..... 20 G TRS ±1 %; VRS ±1 %  
 Shock ..... 100 G TRS ±1 %; VRS ±1 %  
 Load Life  
 .... (@ 70 °C Rated Power 1000 Hours)  
 TRS ±3 %  
 Rotational Life ..... 100 cycles  
 TRS ±3 %  
 Thermal Shock ..... 5 cycles  
 TRS ±2 %; VRS ±1 %

**Physical Characteristics**

Mechanical Angle ..... 240 ° nom.  
 Torque ..... 180 g-cm typical  
 Stop Strength ..... 300 g-cm typical  
 Pushover Strength (Z Style) ..... 2 kilograms (4.4 lbs.) minimum  
 Weight ..... Approximately 0.01 oz.  
 Marking ..... Manufacturer's code, resistance code and date code  
 Wiper ..... 50 % (Actual TR) ±10 %  
 Flammability ..... U.L. 94V-0  
 Standard Packaging  
 J, G and R ..... 500 pcs./7 " reel  
 S and Z ..... 200 pcs./7 " reel  
 H ..... 100 pcs./tube  
 Adjustment Tool ..... H-90

DIMENSIONS:  $\frac{MM}{(INCHES)}$   
 TOLERANCES: ±  $\frac{0.25}{(.010)}$  EXCEPT WHERE NOTED

**Product Dimensions**

3314J-1



RECOMMENDED PCB LAYOUT

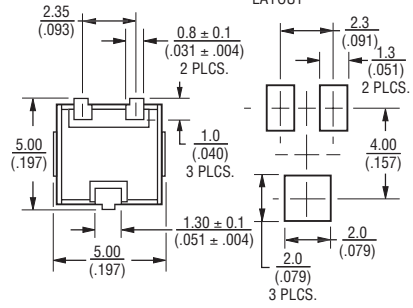

3314G-1

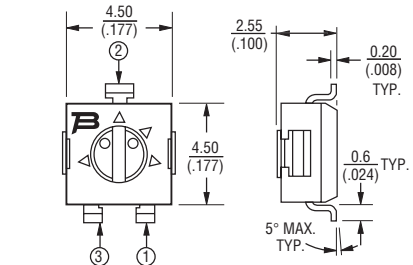

RECOMMENDED PCB LAYOUT

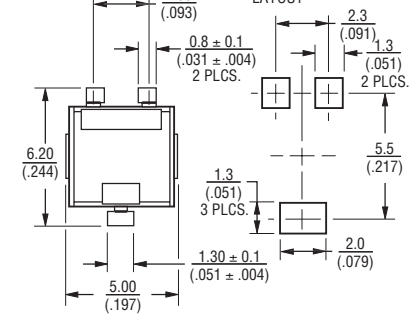

3314J-1, G-1, R-1, H-1 (Bourns Marking, Straight Slot)



3314J-2, G-2, R-2, H-2 (Bourns Marking, Cross Slot)



3314J-3, G-3, R-3, H-3 (Reverse Marking, Straight Slot)



3314J-4, G-4, R-4, H-4 (Reverse Marking, Cross Slot)



**How To Order**

Model **3314 J - 1 - 502 E**  
 Style \_\_\_\_\_  
 Standard or Modified Product Indicator (Styles J, G, R, H & S)  
 -1 = Single Slot  
 -2 = Cross Slot  
 -3 = Single Slot w/Reverse Marking  
 -4 = Cross Slot w/Reverse Marking  
 Product Indicator (Style Z only)  
 -GA4 = Single Slot  
 -1 = Cross Slot  
 -3 = Single Slot w/Reverse Marking  
 -4 = Cross Slot w/Reverse Marking  
 Resistance Code \_\_\_\_\_  
 Embossed Tape Designator\*\*  
 E = Styles J, G and R: 500 pcs./7 " reel  
 Styles S and Z: 200 pcs./7 " reel  
 G = Styles J and G: 3000 pcs./13 " reel  
 Style R: 2500 pcs./13 " reel  
 Styles S and Z: 1000 pcs./13 " reel  
 \*\*Style H is available in tube packaging only.

**Standard Resistance Table**

Resistance (Ohms)	Resistance Code
10	100
20	200
50	500
<b>100</b>	<b>101</b>
<b>200</b>	<b>201</b>
<b>500</b>	<b>501</b>
<b>1,000</b>	<b>102</b>
<b>2,000</b>	<b>202</b>
<b>5,000</b>	<b>502</b>
<b>10,000</b>	<b>103</b>
<b>20,000</b>	<b>203</b>
<b>50,000</b>	<b>503</b>
<b>100,000</b>	<b>104</b>
200,000	204
250,000	254
500,000	504
1,000,000	105
2,000,000	205

Popular distribution values listed in boldface. Special resistances available.

\*RoHS Directive 2002/95/EC Jan. 27, 2003 including annex and RoHS Recast 2011/65/EU June 8, 2011. Specifications are subject to change without notice. Customers should verify actual device performance in their specific applications.

# 3314 - 4 mm Square Trimpot® Trimming Potentiometer

# BOURNS®

## Product Dimensions

3314R-1



3314H-1



## Packaging Specifications - J, G and R Styles

(J, G Styles)

TAPE



(R Style)

TAPE

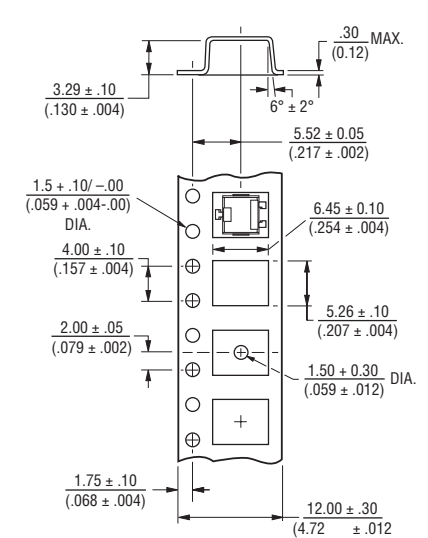

REEL



REEL

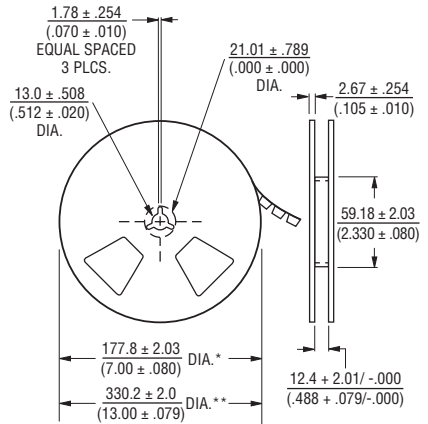

\* Embossed Tape Designator "E"  
\*\* Embossed Tape Designator "G"  
(See How To Order chart for further information.)

Meets EIA specification 481.

\* Embossed Tape Designator "E"  
\*\* Embossed Tape Designator "G"  
(See How To Order chart for further information.)

Meets EIA specification 481.



DIMENSIONS:  $\frac{\text{MM}}{\text{(INCHES)}}$   
TOLERANCES:  $\pm \frac{0.25}{(.010)}$  EXCEPT WHERE NOTED

# 3314 - 4 mm Square Trimpot® Trimming Potentiometer

# BOURNS®

## Product Dimensions

**3314S-1**  
(Bourns Marking, Straight Slot)

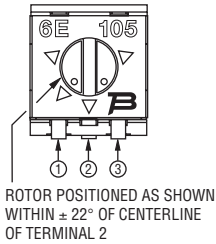

**3314S-2**  
(Bourns Marking, Cross Slot)

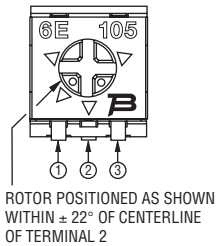

**3314S-3**  
(Reverse Marking, Straight Slot)

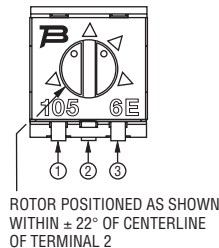

**3314S-4**  
(Reverse Marking, Cross Slot)

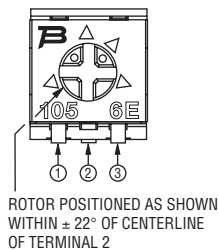

**3314S**  
Common Dimensions



RECOMMENDED PCB LAYOUT



## Packaging Specifications

(S Style)

TAPE

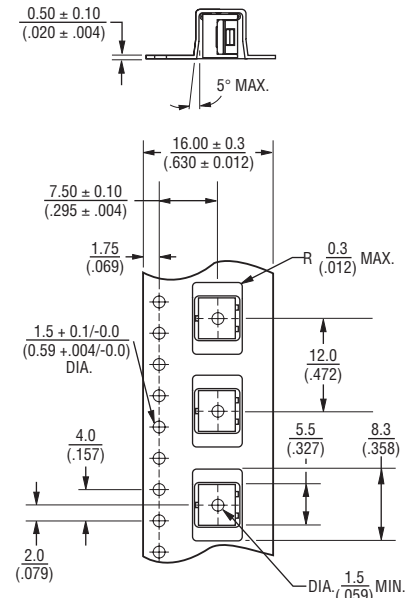

REEL



\* Embossed Tape Designator "E"  
\*\* Embossed Tape Designator "G"  
(See How To Order chart for further information.)

Meets EIA specification 481.

DIMENSIONS:  $\frac{\text{MM}}{\text{(INCHES)}}$

TOLERANCES: ±  $\frac{0.30}{(0.012)}$  EXCEPT WHERE NOTED

# 3314 - 4 mm Square Trimpot® Trimming Potentiometer

# BOURNS®

## Product Dimensions

**3314Z-1-(RC) E**  
(Cross Slot)

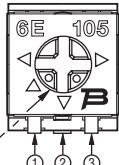

ROTOR POSITIONED AS SHOWN  
WITHIN ± 22° OF CENTERLINE  
OF TERMINAL 2

**3314Z-GA4-(RC) E**  
(Straight Slot)

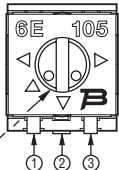

ROTOR POSITIONED AS SHOWN  
WITHIN ± 22° OF CENTERLINE  
OF TERMINAL 2

**3314Z-3**  
(Reverse Marking, Straight Slot)

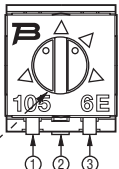

ROTOR POSITIONED AS SHOWN  
WITHIN ± 22° OF CENTERLINE  
OF TERMINAL 2

**3314Z-4-(RC) E**  
(Reverse Marking, Cross Slot)

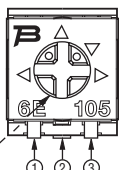

ROTOR POSITIONED AS SHOWN  
WITHIN ± 22° OF CENTERLINE  
OF TERMINAL 2

**3314Z**  
Common Dimensions

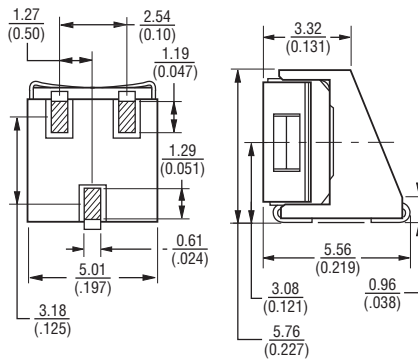

RECOMMENDED PCB LAYOUT

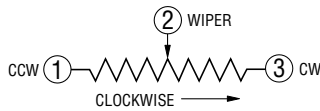
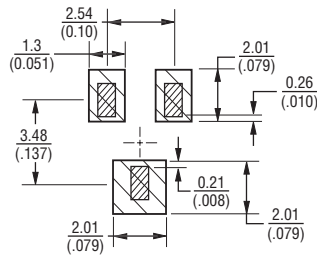

DIMENSIONS:  $\frac{\text{MM}}{\text{INCHES}}$   
 TOLERANCES: ± 0.25 (0.010) EXCEPT WHERE NOTED

## Packaging Specifications

(Z Style)

TAPE

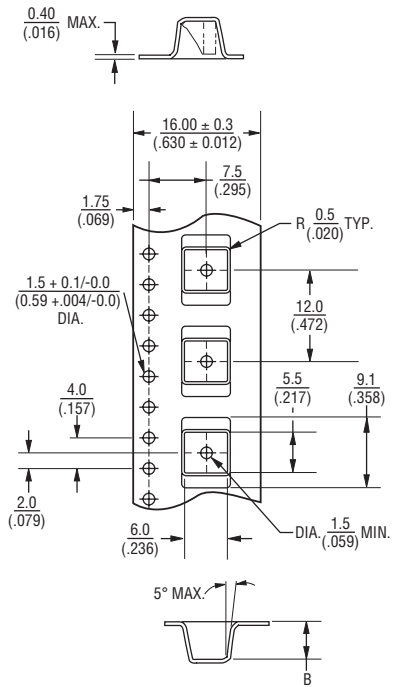

REEL

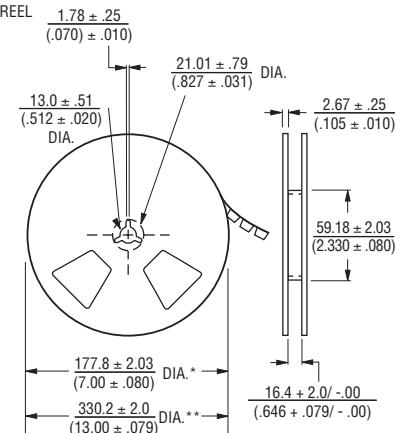

\* Embossed Tape Designator "E"  
 \*\* Embossed Tape Designator "G"  
 (See How To Order chart for further information.)

Meets EIA specification 481.

Компания «Life Electronics» занимается поставками электронных компонентов импортного и отечественного производства от производителей и со складов крупных дистрибьюторов Европы, Америки и Азии.

С конца 2013 года компания активно расширяет линейку поставок компонентов по направлению коаксиальный кабель, кварцевые генераторы и конденсаторы (керамические, пленочные, электролитические), за счёт заключения дистрибьюторских договоров

Мы предлагаем:

- Конкурентоспособные цены и скидки постоянным клиентам.
- Специальные условия для постоянных клиентов.
- Подбор аналогов.
- Поставку компонентов в любых объемах, удовлетворяющих вашим потребностям.
- Приемлемые сроки поставки, возможна ускоренная поставка.
- Доставку товара в любую точку России и стран СНГ.
- Комплексную поставку.
- Работу по проектам и поставку образцов.
- Формирование склада под заказчика.
- Сертификаты соответствия на поставляемую продукцию (по желанию клиента).
- Тестирование поставляемой продукции.
- Поставку компонентов, требующих военную и космическую приемку.
- Входной контроль качества.
- Наличие сертификата ISO.

В составе нашей компании организован Конструкторский отдел, призванный помогать разработчикам, и инженерам.

Конструкторский отдел помогает осуществить:

- Регистрацию проекта у производителя компонентов.
- Техническую поддержку проекта.
- Защиту от снятия компонента с производства.
- Оценку стоимости проекта по компонентам.
- Изготовление тестовой платы монтаж и пусконаладочные работы.



Тел: +7 (812) 336 43 04 (многоканальный)

Email: [org@lifeelectronics.ru](mailto:org@lifeelectronics.ru)