

Inverter Grade Thyristors (Hockey PUK Version), 390 A



TO-200AB (A-PUK)

FEATURES

- Metal case with ceramic insulator
- All diffused design
- Center amplifying gate
- Guaranteed high dV/dt
- International standard case TO-200AB (A-PUK)
- Guaranteed high dI/dt
- High surge current capability
- Low thermal impedance
- High speed performance
- Material categorization: for definitions of compliance please see www.vishay.com/doc?99912

**RoHS
COMPLIANT**
PRODUCT SUMMARY

Package	TO-200AB (A-PUK)
Diode variation	Single SCR
$I_{T(AV)}$	390 A
V_{DRM}/V_{RRM}	400 V, 800 V
V_{TM}	1.58 V
I_{TSM} at 50 Hz	5260 A
I_{TSM} at 60 Hz	5510 A
I_{GT}	200 mA
T_C/T_{hs}	55 °C

TYPICAL APPLICATIONS

- Inverters
- Choppers
- Induction heating
- All types of force-commutated converters

MAJOR RATINGS AND CHARACTERISTICS

PARAMETER	TEST CONDITIONS	VALUES	UNITS
$I_{T(AV)}$		390	A
	T_{hs}	55	°C
$I_{T(RMS)}$		745	A
	T_{hs}	25	°C
I_{TSM}	50 Hz	5850	A
	60 Hz	6130	
I^2t	50 Hz	171	kA ² s
	60 Hz	156	
V_{DRM}/V_{RRM}		400 to 800	V
t_q	Range	10 to 30	μs
T_J		-40 to +125	°C

ELECTRICAL SPECIFICATIONS
VOLTAGE RATINGS

TYPE NUMBER	VOLTAGE CODE	V_{DRM}/V_{RRM} , MAXIMUM REPETITIVE PEAK VOLTAGE V	V_{RSM} , MAXIMUM NON-REPETITIVE PEAK VOLTAGE V	I_{DRM}/I_{RRM} MAXIMUM AT $T_J = T_J$ MAXIMUM mA
VS-ST223C..C	04	400	500	40
	08	800	900	



CURRENT CARRYING CAPABILITY							
FREQUENCY							UNITS
50 Hz	930	800	1430	1220	5870	5240	A
400 Hz	910	770	1490	1300	3120	2740	
1000 Hz	780	650	1430	1260	1880	1640	
2500 Hz	490	400	1070	920	1000	860	
Recovery voltage V_r	50		50		50		V
Voltage before turn-on V_d	V_{DRM}		V_{DRM}		V_{DRM}		
Rise of on-state current di/dt	50		-		-		A/μs
Heatsink temperature	40	55	40	55	40	55	°C
Equivalent values for RC circuit	47/0.22		47/0.22		47/0.22		Ω/μF

ON-STATE CONDUCTION						
PARAMETER	SYMBOL	TEST CONDITIONS			VALUES	UNITS
Maximum average on-state current at heatsink temperature	$I_{T(AV)}$	180° conduction, half sine wave Double side (single side) cooled			390 (150)	A
					55 (85)	°C
Maximum RMS on-state current	$I_{T(RMS)}$	DC at 25 °C heatsink temperature double side cooled			745	
Maximum peak, one half cycle, non-repetitive surge current	I_{TSM}	t = 10 ms	No voltage reapplied	Sinusoidal half wave, initial $T_J = T_J$ maximum	5850	A
					t = 8.3 ms	
		t = 10 ms	100 % V_{RRM} reapplied		4920	
		t = 8.3 ms	5150			
Maximum I^2t for fusing	I^2t	t = 10 ms	No voltage reapplied		171	kA ² s
					t = 8.3 ms	
		t = 10 ms	100 % V_{RRM} reapplied		121	
		t = 8.3 ms	110			
Maximum $I^2\sqrt{t}$ for fusing	$I^2\sqrt{t}$	t = 0.1 to 10 ms, no voltage reapplied			1710	kA ² √s
Maximum peak on-state voltage	V_{TM}	$I_{TM} = 600$ A, $T_J = T_J$ maximum, $t_p = 10$ ms sine wave pulse			1.58	V
Low level value of threshold voltage	$V_{T(TO)1}$	$(16.7 \% \times \pi \times I_{T(AV)}) < I < \pi \times I_{T(AV)}$, $T_J = T_J$ maximum			1.05	
High level value of threshold voltage	$V_{T(TO)2}$	$I > \pi \times I_{T(AV)}$, $T_J = T_J$ maximum			1.09	
Low level value of forward slope resistance	r_{11}	$(16.7 \% \times \pi \times I_{T(AV)}) < I < \pi \times I_{T(AV)}$, $T_J = T_J$ maximum			0.88	mΩ
High level value of forward slope resistance	r_{12}	$I > \pi \times I_{T(AV)}$, $T_J = T_J$ maximum			0.82	
Maximum holding current	I_H	$T_J = 25$ °C, $I_T > 30$ A			600	mA
Typical latching current	I_L	$T_J = 25$ °C, $V_A = 12$ V, $R_a = 6$ Ω, $I_G = 1$ A			1000	

SWITCHING					
PARAMETER	SYMBOL	TEST CONDITIONS	VALUES		UNITS
			MIN.	MAX.	
Maximum non-repetitive rate of rise of turned on current	di/dt	$T_J = T_J$ maximum, $V_{DRM} = \text{Rated } V_{DRM}$, $I_{TM} = 2 \times di/dt$	1000		A/μs
Typical delay time	t_d	$T_J = 25$ °C, $V_{DM} = \text{Rated } V_{DRM}$, $I_{TM} = 50$ A DC, $t_p = 1$ μs Resistive load, gate pulse: 10 V, 5 Ω source	0.78		μs
Maximum turn-off time	t_q	$T_J = T_J$ maximum, $I_{TM} = 300$ A, commutating $di/dt = 20$ A/μs $V_R = 50$ V, $t_p = 500$ μs, dV/dt : See table in device code	10	30	



BLOCKING				
PARAMETER	SYMBOL	TEST CONDITIONS	VALUES	UNITS
Maximum critical rate of rise of off-state voltage	dV/dt	T _J = T _J maximum, linear to 80 % V _{DRM} , higher value available on request	500	V/μs
Maximum peak reverse and off-state leakage current	I _{RRM} , I _{DRM}	T _J = T _J maximum, rated V _{DRM} /V _{RRM} applied	40	mA

TRIGGERING				
PARAMETER	SYMBOL	TEST CONDITIONS	VALUES	UNITS
Maximum peak gate power	P _{GM}	T _J = T _J maximum, f = 50 Hz, d% = 50	60	W
Maximum average gate power	P _{G(AV)}		10	
Maximum peak positive gate current	I _{GM}	T _J = T _J maximum, t _p ≤ 5 ms	10	A
Maximum peak positive gate voltage	+V _{GM}		20	
Maximum peak negative gate voltage	-V _{GM}		5	
Maximum DC gate current required to trigger	I _{GT}	T _J = 25 °C, V _A = 12 V, R _a = 6 Ω	200	mA
Maximum DC gate voltage required to trigger	V _{GT}		3	
Maximum DC gate current not to trigger	I _{GD}	T _J = T _J maximum, rated V _{DRM} applied	20	mA
Maximum DC gate voltage not to trigger	V _{GD}		0.25	

THERMAL AND MECHANICAL SPECIFICATIONS				
PARAMETER	SYMBOL	TEST CONDITIONS	VALUES	UNITS
Maximum operating temperature range	T _J		-40 to +125	°C
Maximum storage temperature range	T _{Stg}		-40 to +150	
Maximum thermal resistance, junction to heatsink	R _{thJ-hs}	DC operation single side cooled	0.17	K/W
		DC operation double side cooled	0.08	
Maximum thermal resistance, case to heatsink	R _{thC-hs}	DC operation single side cooled	0.033	
		DC operation double side cooled	0.017	
Mounting force, ± 10 %			4900 (500)	N (kg)
Approximate weight			50	g
Case style		See dimensions - link at the end of datasheet	TO-200AB (A-PUK)	

ΔR _{thJ-hs} CONDUCTION						
CONDUCTION ANGLE	SINUSOIDAL CONDUCTION		RECTANGULAR CONDUCTION		TEST CONDITIONS	UNITS
	Single Side	Double Side	Single Side	Double Side		
180°	0.015	0.017	0.011	0.011	T _J = T _J maximum	K/W
120°	0.019	0.019	0.019	0.019		
90°	0.024	0.024	0.026	0.026		
60°	0.035	0.035	0.036	0.037		
30°	0.060	0.060	0.060	0.061		

Note

- The table above shows the increment of thermal resistance R_{thJ-hs} when devices operate at different conduction angles than DC

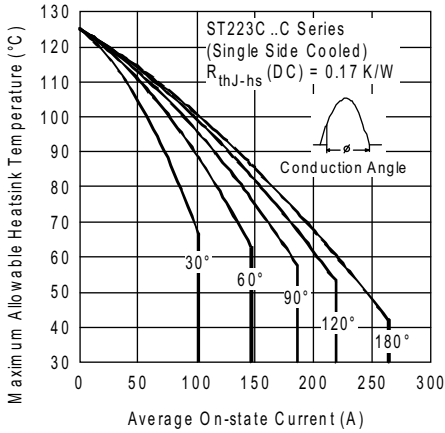

Fig. 1 - Current Ratings Characteristics

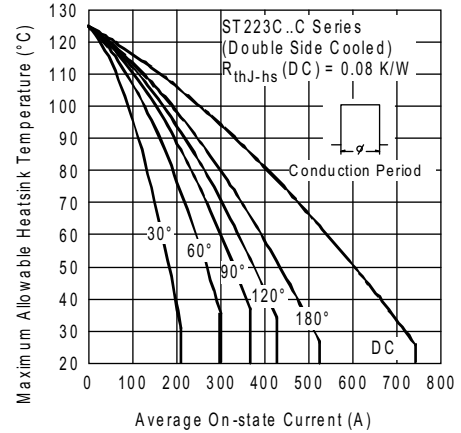

Fig. 4 - Current Ratings Characteristics

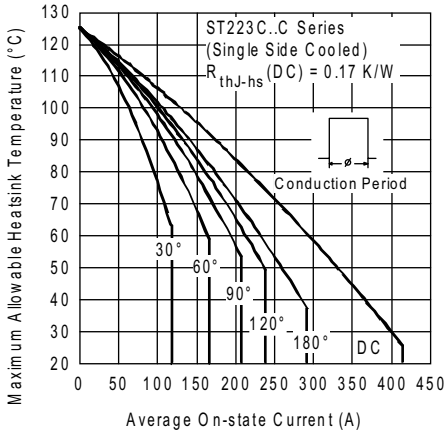

Fig. 2 - Current Ratings Characteristics

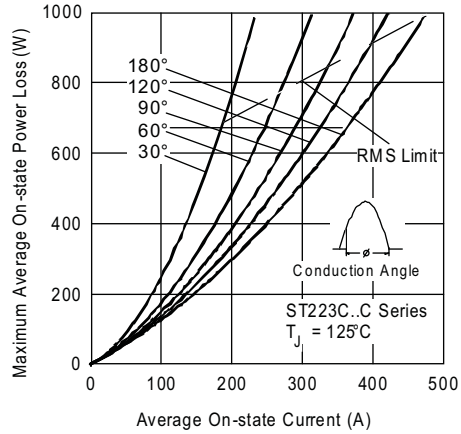

Fig. 5 - On-State Power Loss Characteristics

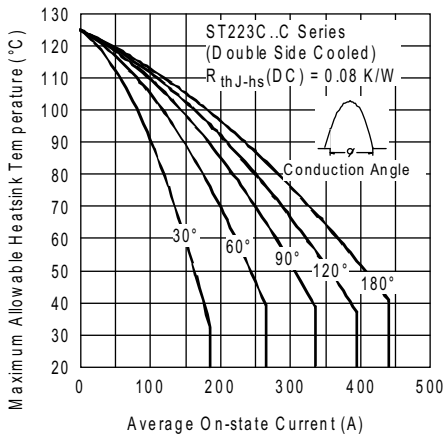

Fig. 3 - Current Ratings Characteristics

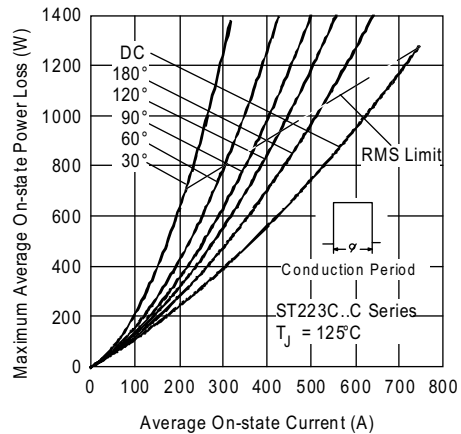

Fig. 6 - On-State Power Loss Characteristics

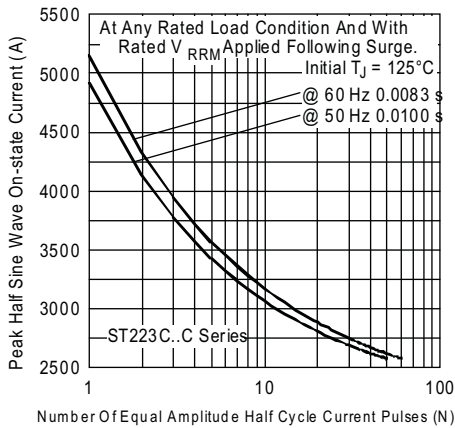

Fig. 7 - Maximum Non-Repetitive Surge Current Single and Double Side Cooled

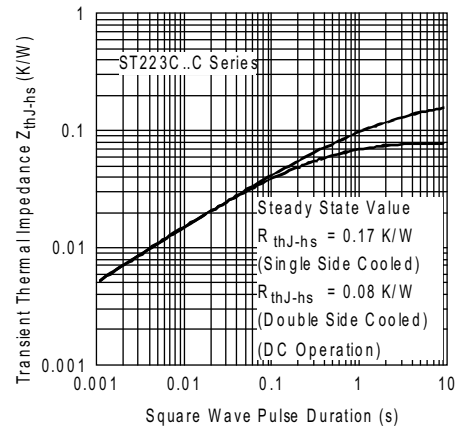

Fig. 10 - Thermal Impedance Z_{thJ-hs} Characteristics

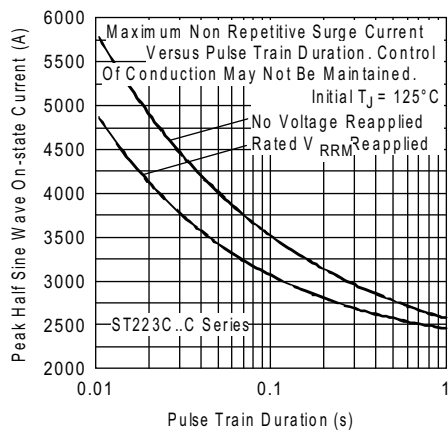

Fig. 8 - Maximum Non-Repetitive Surge Current Single and Double Side Cooled

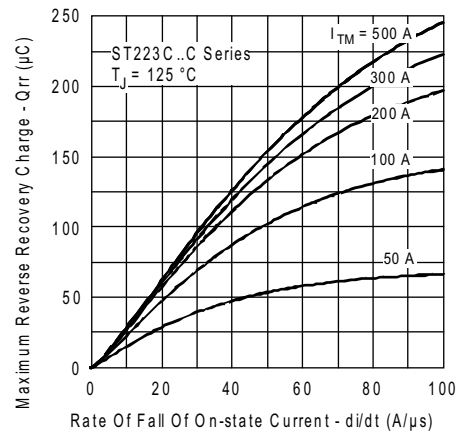

Fig. 11 - Reverse Recovered Charge Characteristics

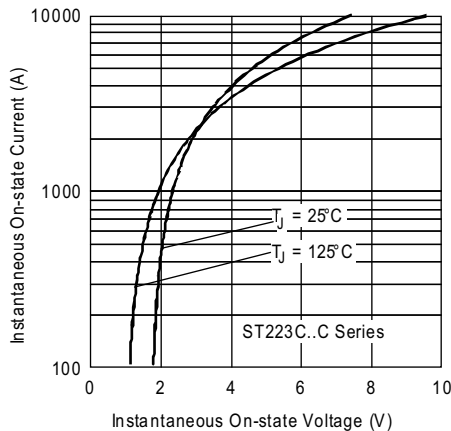

Fig. 9 - On-State Voltage Drop Characteristics

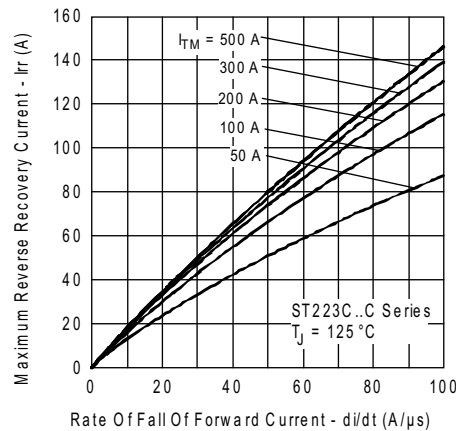

Fig. 12 - Reverse Recovered Current Characteristics

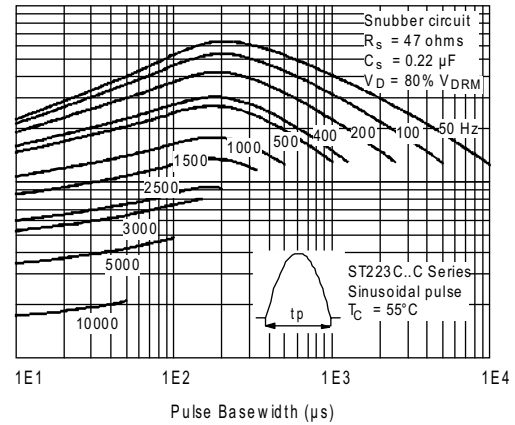
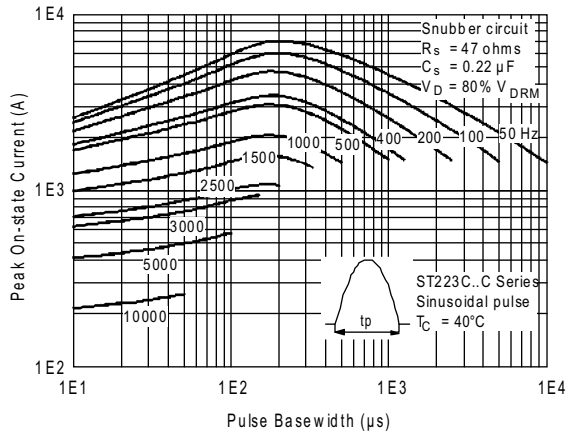

Fig. 13 - Frequency Characteristics

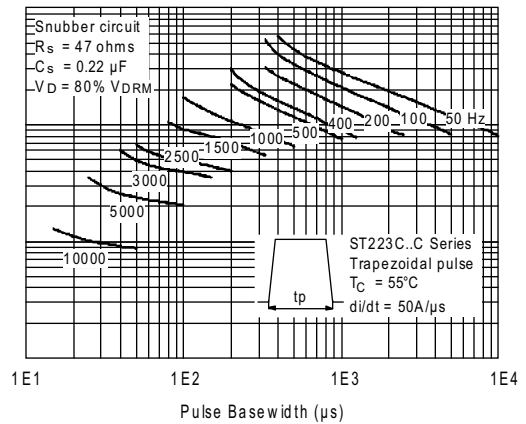
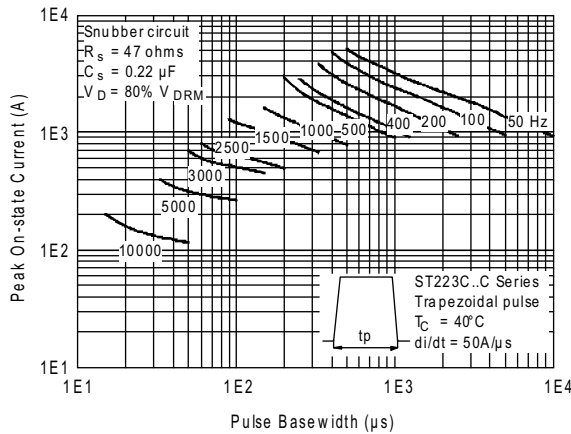

Fig. 14 - Frequency Characteristics

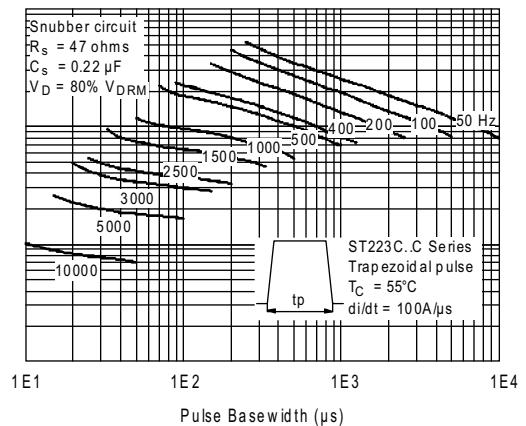
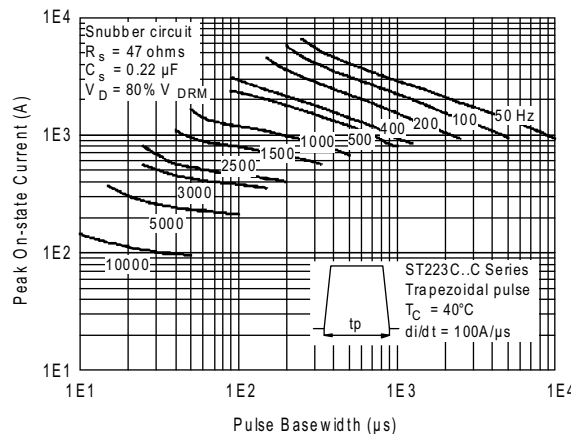

Fig. 15 - Frequency Characteristics

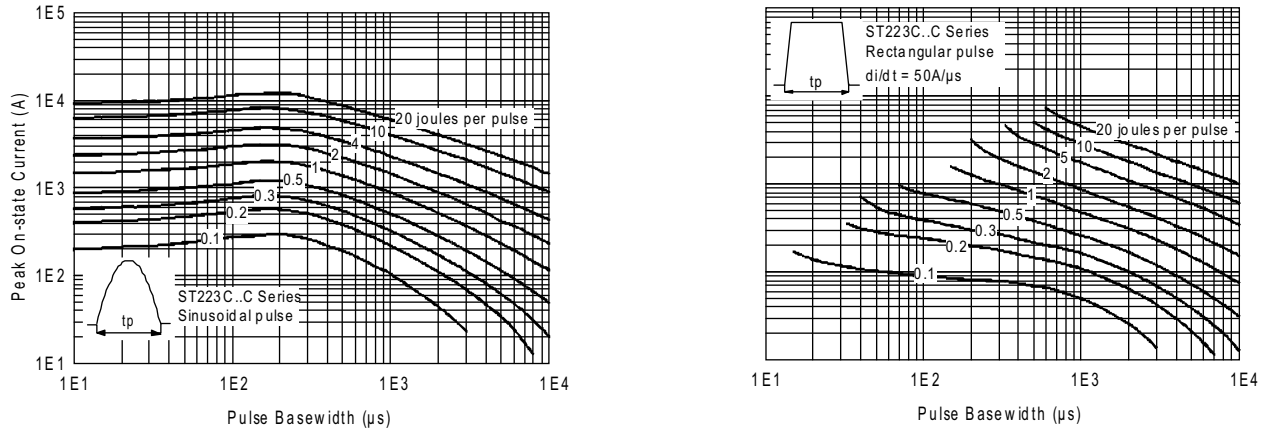

Fig. 16 - Maximum On-State Energy Power Loss Characteristics

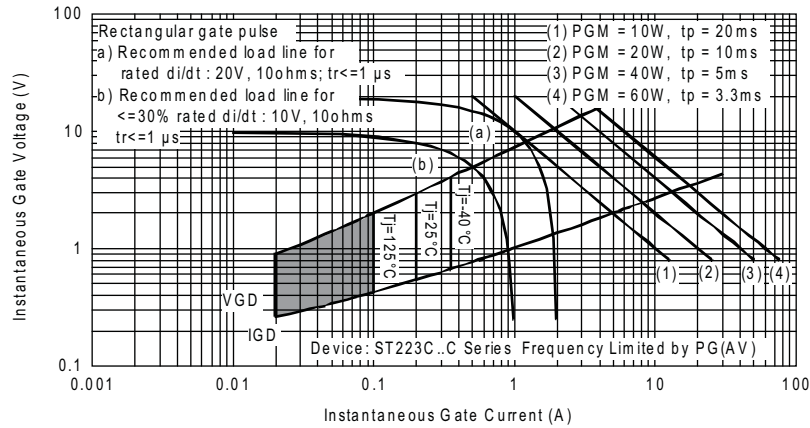
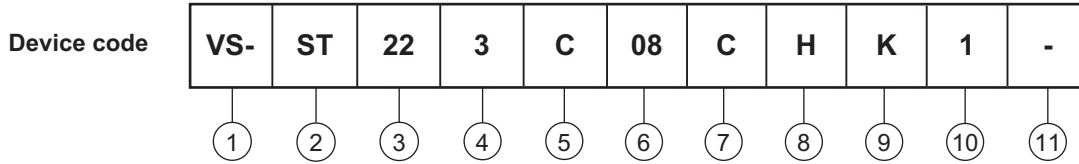

Fig. 17 - Gate Characteristics



ORDERING INFORMATION TABLE



- 1** - Vishay Semiconductors product
- 2** - Thyristor
- 3** - Essential part number
- 4** - 3 = Fast turn off
- 5** - C = Ceramic PUK
- 6** - Voltage code x 100 = V_{RRM} (see Voltage Ratings table)
- 7** - C = PUK case TO-200AB (A-PUK)
- 8** - Reapplied dV/dt code (for t_q test condition)
- 9** - t_q code
- 10** - 0 = Eyelet term.
(gate and aux. cathode unsoldered leads)
1 = Fast-on term.
(gate and aux. cathode unsoldered leads)
2 = Eyelet term.
(gate and aux. cathode soldered leads)
3 = Fast-on term.
(gate and aux. cathode soldered leads)
- 11** - Critical dV/dt :
 - None = 500 V/ μ s (standard value)
 - L = 1000 V/ μ s (special selection)

$dV/dt - t_q$ combinations available					
dV/dt (V/μs)	20	50	100	200	400
10	CN	DN	EN	FN*	--
12	CM	DM	EM	FM	--
15	CL	DL	EL	FL*	HL
18	CP	DP	EP	FP	HP
20	CK	DK	EK	FK	HK
25	--	--	--	--	HJ
30	--	--	--	--	HH

* Standard part number.
All other types available only on request.

LINKS TO RELATED DOCUMENTS	
Dimensions	www.vishay.com/doc?95074

TO-200AB (A-PUK)

DIMENSIONS in millimeters (inches)

Anode to gate
 Creepage distance: 7.62 (0.30) minimum
 Strike distance: 7.12 (0.28) minimum



Quote between upper and lower pole pieces has to be considered after application of mounting force (see thermal and mechanical specification)



Disclaimer

ALL PRODUCT, PRODUCT SPECIFICATIONS AND DATA ARE SUBJECT TO CHANGE WITHOUT NOTICE TO IMPROVE RELIABILITY, FUNCTION OR DESIGN OR OTHERWISE.

Vishay Intertechnology, Inc., its affiliates, agents, and employees, and all persons acting on its or their behalf (collectively, "Vishay"), disclaim any and all liability for any errors, inaccuracies or incompleteness contained in any datasheet or in any other disclosure relating to any product.

Vishay makes no warranty, representation or guarantee regarding the suitability of the products for any particular purpose or the continuing production of any product. To the maximum extent permitted by applicable law, Vishay disclaims (i) any and all liability arising out of the application or use of any product, (ii) any and all liability, including without limitation special, consequential or incidental damages, and (iii) any and all implied warranties, including warranties of fitness for particular purpose, non-infringement and merchantability.

Statements regarding the suitability of products for certain types of applications are based on Vishay's knowledge of typical requirements that are often placed on Vishay products in generic applications. Such statements are not binding statements about the suitability of products for a particular application. It is the customer's responsibility to validate that a particular product with the properties described in the product specification is suitable for use in a particular application. Parameters provided in datasheets and/or specifications may vary in different applications and performance may vary over time. All operating parameters, including typical parameters, must be validated for each customer application by the customer's technical experts. Product specifications do not expand or otherwise modify Vishay's terms and conditions of purchase, including but not limited to the warranty expressed therein.

Except as expressly indicated in writing, Vishay products are not designed for use in medical, life-saving, or life-sustaining applications or for any other application in which the failure of the Vishay product could result in personal injury or death. Customers using or selling Vishay products not expressly indicated for use in such applications do so at their own risk. Please contact authorized Vishay personnel to obtain written terms and conditions regarding products designed for such applications.

No license, express or implied, by estoppel or otherwise, to any intellectual property rights is granted by this document or by any conduct of Vishay. Product names and markings noted herein may be trademarks of their respective owners.

Material Category Policy

Vishay Intertechnology, Inc. hereby certifies that all its products that are identified as RoHS-Compliant fulfill the definitions and restrictions defined under Directive 2011/65/EU of The European Parliament and of the Council of June 8, 2011 on the restriction of the use of certain hazardous substances in electrical and electronic equipment (EEE) - recast, unless otherwise specified as non-compliant.

Please note that some Vishay documentation may still make reference to RoHS Directive 2002/95/EC. We confirm that all the products identified as being compliant to Directive 2002/95/EC conform to Directive 2011/65/EU.

Vishay Intertechnology, Inc. hereby certifies that all its products that are identified as Halogen-Free follow Halogen-Free requirements as per JEDEC JS709A standards. Please note that some Vishay documentation may still make reference to the IEC 61249-2-21 definition. We confirm that all the products identified as being compliant to IEC 61249-2-21 conform to JEDEC JS709A standards.

Компания «Life Electronics» занимается поставками электронных компонентов импортного и отечественного производства от производителей и со складов крупных дистрибьюторов Европы, Америки и Азии.

С конца 2013 года компания активно расширяет линейку поставок компонентов по направлению коаксиальный кабель, кварцевые генераторы и конденсаторы (керамические, пленочные, электролитические), за счёт заключения дистрибьюторских договоров

Мы предлагаем:

- Конкурентоспособные цены и скидки постоянным клиентам.
- Специальные условия для постоянных клиентов.
- Подбор аналогов.
- Поставку компонентов в любых объемах, удовлетворяющих вашим потребностям.
- Приемлемые сроки поставки, возможна ускоренная поставка.
- Доставку товара в любую точку России и стран СНГ.
- Комплексную поставку.
- Работу по проектам и поставку образцов.
- Формирование склада под заказчика.
- Сертификаты соответствия на поставляемую продукцию (по желанию клиента).
- Тестирование поставляемой продукции.
- Поставку компонентов, требующих военную и космическую приемку.
- Входной контроль качества.
- Наличие сертификата ISO.

В составе нашей компании организован Конструкторский отдел, призванный помогать разработчикам, и инженерам.

Конструкторский отдел помогает осуществить:

- Регистрацию проекта у производителя компонентов.
- Техническую поддержку проекта.
- Защиту от снятия компонента с производства.
- Оценку стоимости проекта по компонентам.
- Изготовление тестовой платы монтаж и пусконаладочные работы.



Тел: +7 (812) 336 43 04 (многоканальный)
Email: org@lifeelectronics.ru