

ABC200 Series

AC-DC Open Frame Power Supplies

ABC200 Series is a family of compact and efficient AC-DC power supplies suited for telecom datacom and many other industrial applications.

This family meets the international information technology safety standards with the CE-Mark for the European Low Voltage Directive (LVD).

Their high efficiency allows a very minimal power loss in end equipment, resulting in higher reliability, ease of thermal management and regulatory approvals for an environmentally friendly end product.

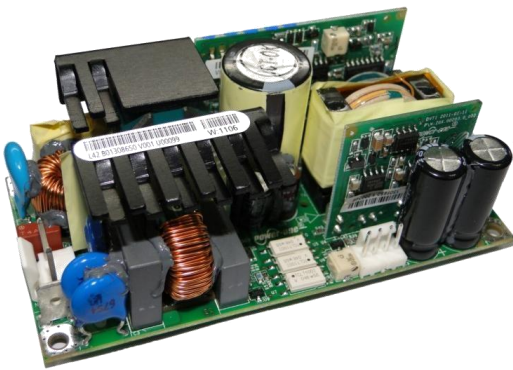

Key Features & Benefits

- High Efficiency up to 91% at 230 VAC
- Universal AC Input Voltage Range: 90-264 VAC
- Active Power Factor Correction
- Over temperature, output overvoltage, overcurrent and short circuit protection
- Low Conducted and Radiated EMI (EN 55022 cl A)
- Safety approved to the latest edition of the following standards: CSA/UL60950-1, EN60950-1 and IEC60950-1
- High Power Density Design: 15 W/in³
- Compact Size: 2.0 (W) x 4.0 (L) x 1.5 (H) inches
- RoHS Compliant
- CE Marked

Applications

- Industrial Applications
- Telecom
- Daracom



bel POWER
SOLUTIONS &
PROTECTION

a bel group

belpowersolutions.com

1. MODEL SELECTION

MODEL	INPUT VOLTAGE	OUTPUT VOLTAGE	NOM OUTPUT CURRENT	# OF OUTPUTS	OUTPUT POWER
ABC200-1012G	90 – 264 VAC	12 VDC	15 A	1	200 W
ABC200-1024G	90 – 264 VAC	24 VDC	8.5 A	1	200 W
ABC200-1048G	90 – 264 VAC	48 VDC	4.2 A	1	200 W

2. OVERVIEW

The ABC200-10XXG is a high efficiency and high power With 1 m/s system air cooling, the ABC200-1012G can density AC to DC power supply. It incorporates boundary deliver up to 180 W continuous output power, and 204W for conduction mode (BCM) PFC converter and soft-switching ABC200-1024G and the ABC200-1048G. LLC converter, providing increased system reliability and high efficiency.

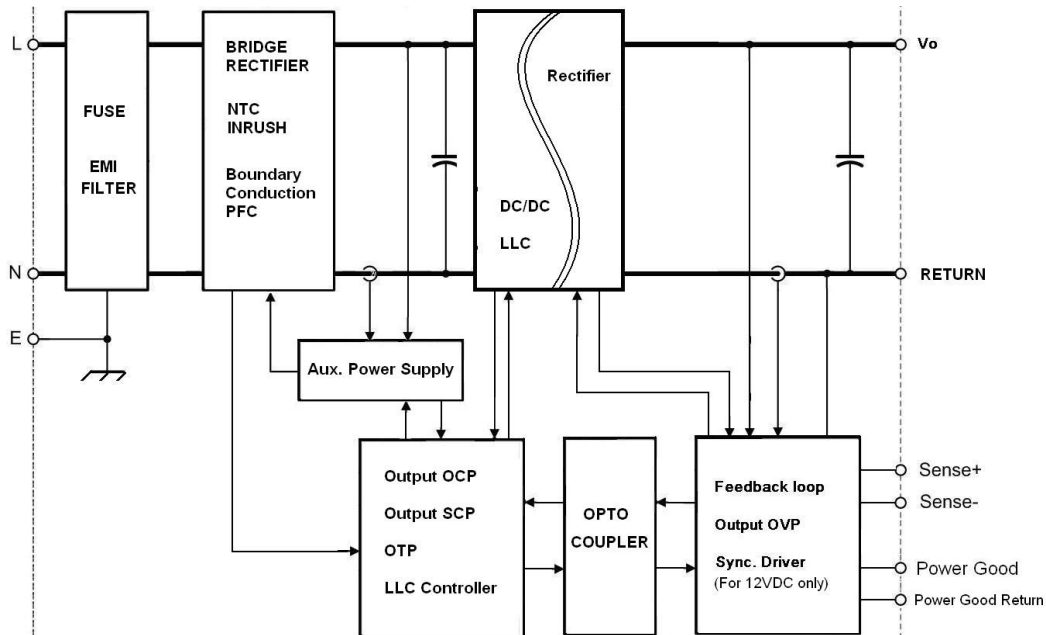

Figure 1. ABC200-10XXG block diagram

3. ABSOLUTE MAXIMUM RATINGS

Stresses in excess of the absolute maximum ratings may cause performance degradation, adversely affect long-term reliability, and cause permanent damage to the supply.

PARAMETER	CONDITIONS / DESCRIPTION	MIN	NOM	MAX	UNIT
$V_{I\max}$	Max Continuous Input			264	VAC
				300	VAC

4. INPUT SPECIFICATIONS

General Condition: $T_A = -10... 50\text{ }^\circ\text{C}$ unless otherwise noted. Active fan air cooling required: 200 LFM (1 m/s)

PARAMETER	CONDITIONS / DESCRIPTION	MIN	NOM	MAX	UNIT		
V_{nom}	Nominal Input Voltage	100		240	VAC		
V_I	Input Voltage Ranges	Normal operating ($V_{I,min}$ to $V_{I,max}$)		264	VAC		
I_{max}	Max Input Current	At 90 VAC input and max rating		2.75	A_{rms}		
I_p	Inrush Current Limitation	$V_{nom} = 115\text{ VAC}, T = 25^\circ\text{C}$ (see Figure 2)		40	A_p		
		$V_{nom} = 230\text{ VAC}, T = 25^\circ\text{C}$ (see Figure 3)		80			
f_I	Input Frequency	47	50/60	63	Hz		
PF	Power Factor	Normal input, half load and above		0.9			
V_{on}	Turn-On Input Voltage ¹	Ramping up		85	87	90	VAC
V_{off}	Turn-Off Input Voltage ¹	Ramping down		80	83	85	VAC
η	Efficiency	$V_{nom} = 230\text{ VAC}, 0.5 \cdot I_{o,nom}, V_o, nom, T_A = 25\text{ }^\circ\text{C}$		89		%	
		$V_{nom} = 230\text{ VAC}, 1.0 \cdot I_{o,nom}, V_o, nom, T_A = 25\text{ }^\circ\text{C}$		91			
T_{hold}	Hold-Up Time	After last AC zero point, V_o within regulation, $V_I = 115\text{ VAC}, P_o, nom$		10		ms	

1) The power supply is provided with the hysteresis loop (about 4.5V) during turn-on and turn-off within the ranges.

4.1 INPUT FUSE

A slow-blow 5A input fuse (5 × 20 mm) in series with live line inside the power supply protects against severe defects. The fuse and a VDR form together with the input filter an effective protection against high input transients.

4.2 INRUSH CURRENT

The AC-DC power supply exhibits an X-capacitance of only about 1.0 μF , resulting in a low and short peak current, when the supply is connected to the mains. The internal bulk capacitor will be charged through a NTC resistor which will limit the inrush current (see Figure 2 and 3).

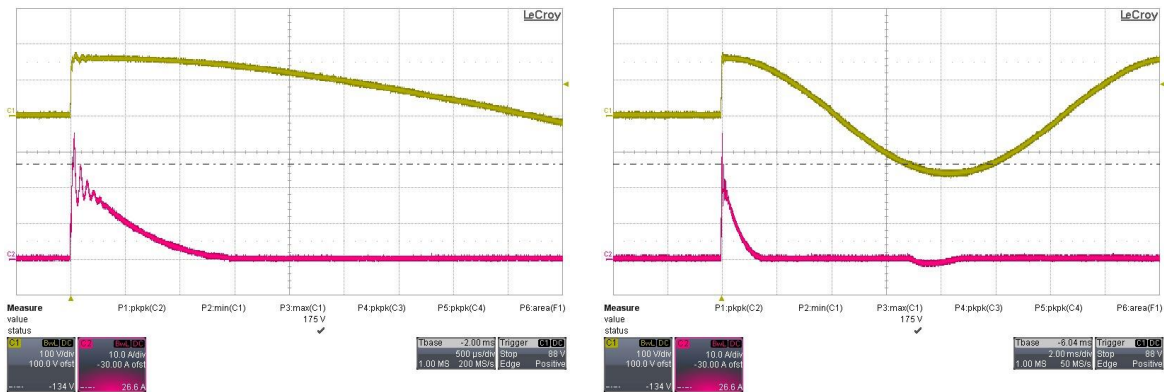

Figure 2. Inrush current, $V_{in} = 115\text{ Vac}, 90^\circ$ CH1: V_{in} (100V/div), CH2: I_{in} (10A/div)

¹ The power supply is provided with the hysteresis loop (about 4.5V) during turn-on and turn-off within the ranges.



Asia-Pacific
+86 755 298 85888

Europe, Middle East
+353 61 225 977

North America
+1 408 785 5200

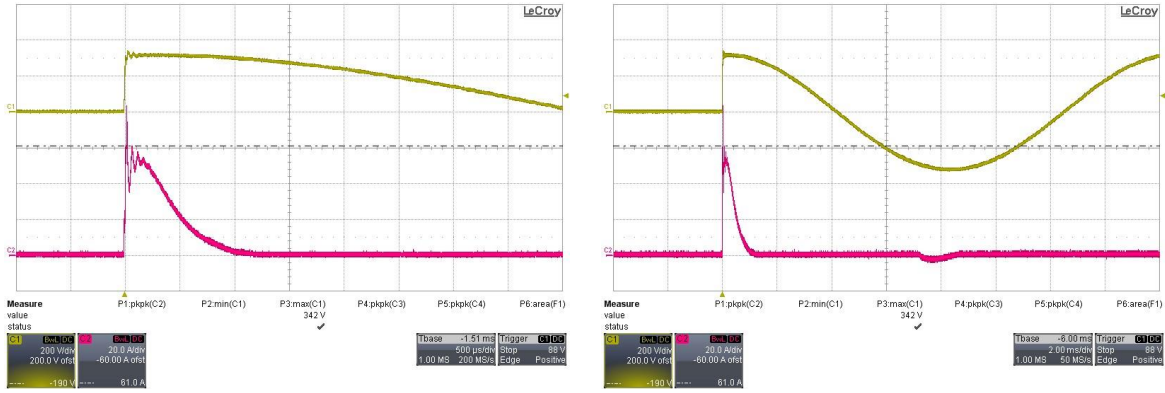

Figure 3. Inrush current, $V_{in} = 230Vac, 90^\circ$ CH1: V_{in} (200V/div), CH2: I_{in} (20A/div)

4.3 INPUT UNDER-VOLTAGE

If the sinusoidal input voltage stays below the input under voltage lockout threshold V_{on} , the supply will be inhibited. Once the input voltage returns within the normal operating range, the supply will return to normal operation again.

4.4 POWER FACTOR CORRECTION

Power factor correction (PFC) is achieved by controlling the input current waveform synchronously with the input voltage. A specified PFC controller is implemented in the boundary conduction mode topology giving outstanding PFC results over a wide input voltage and load ranges. The input current will follow the shape of the input voltage.

4.5 EFFICIENCY

The high efficiency (see Figure 4) is achieved by using soft switching LLC technology with boundary conduction mode PFC topology minimizing switching losses. Synchronous rectifiers on the output reduce the losses in the high current A Schottky or ultra fast diode is used as the rectifier in the output path for ABC200-1012G. ABC200-1024G and ABC200-1048G because of the high output voltage level.

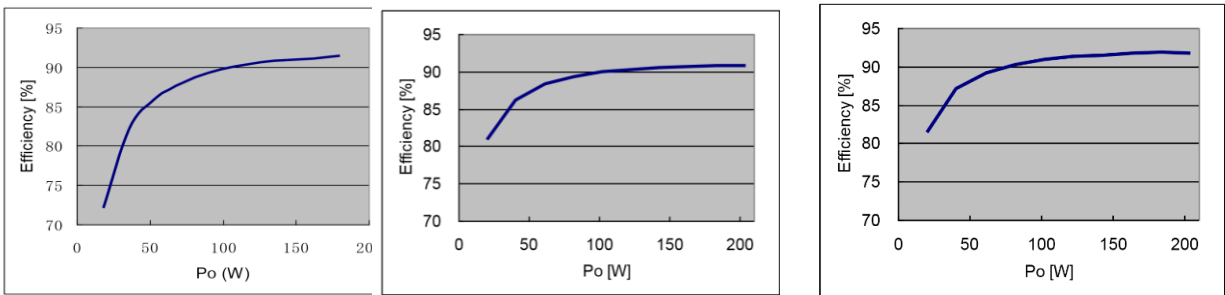

Efficiency vs. Output Power at 230VAC, ABC200-1012G Efficiency vs. Output Power at 230VAC, ABC200-1024G Efficiency vs. Output Power at 230VAC, ABC200-1048G

Figure 4. Efficiency Curves

5 OUTPUT SPECIFICATIONS

General Condition: $T_A = -10$ to $+50^\circ\text{C}$ unless otherwise noted. Derate linearly from 50°C to 50% at 70°C .
Active fan air cooling required: 200 LFM (1 m/s).

PARAMETER	CONDITIONS / DESCRIPTION		MIN	NOM	MAX	UNIT
Main Output V_O						
V_O Nominal Output Voltage	$0.5 \cdot I_O, T_{\text{amb}} = 25^\circ\text{C},$	ABC200-1012G		12.0		
		ABC200-1024G		24.0		VDC
		ABC200-1048G		48.0		
V_O set Output Setpoint Accuracy	$0.5 \cdot I_O, T_{\text{amb}} = 25^\circ\text{C}$	ABC200-1012G	11.95		12.05	
		ABC200-1024G	23.90		24.10	VDC
		ABC200-1048G	47.80		48.20	
P_O Nominal Output Power		ABC200-1012G		180		W
		ABC200-1024G		204		W
		ABC200-1048G		204		W
I_O Nominal Output Current		ABC200-1012G		13	15	ADC
		ABC200-1024G		7.5	8.5	ADC
		ABC200-1048G		3.5	4.25	ADC
V_O ripple Output Ripple & Noise	V_O nom, I_O nom, 20 MHz BW	ABC200-1012G			120	mV
		ABC200-1024G			240	mV
		ABC200-1048G			480	mV
d V_O Load Regulation	$I = I$ nom, 0 - 100% I_O nom,	ABC200-1012G		60	120	mV
		ABC200-1024G		120	240	mV
		ABC200-1048G		240	480	mV
d I Line Line Regulation	$I = I$ min... I max,	ABC200-1012G		12	120	mV
		ABC200-1024G		24	240	mV
		ABC200-1048G		96	480	mV
d V_{dyn} Dynamic Load Regulation	$\Delta I_O = 50\% I_{O \text{ nom}},$ $I_O = 50 \dots 100\% I_{O \text{ max}},$ $dI_O/dt = 1 \text{ A}/\mu\text{s},$ recovery within 5% of $V_{O \text{ nom}}$	ABC200-1012G			0.6	VDC
		ABC200-1024G			1.2	VDC
		ABC200-1048G			2.4	VDC
T_{rec} Recovery Time		ABC200-10XXG			2	ms
t_{Delay} Turn On Delay Time	See Figure 5 and Figure 6		0	1.5	2.5	sec
t_{rise} Rise Time	$V_O = 10 \dots 90\% V_{O \text{ nom}}$ (see Figure 10) Note: For ABC200-1048G, maximum rise time is 30 ms				20	ms
C_{Load} Capacitive Loading	$T_{\text{amb}} = 25^\circ\text{C}$	ABC200-1012G			3300	μF
		ABC200-1024G			1800	μF
		ABC200-1048G			1000	μF

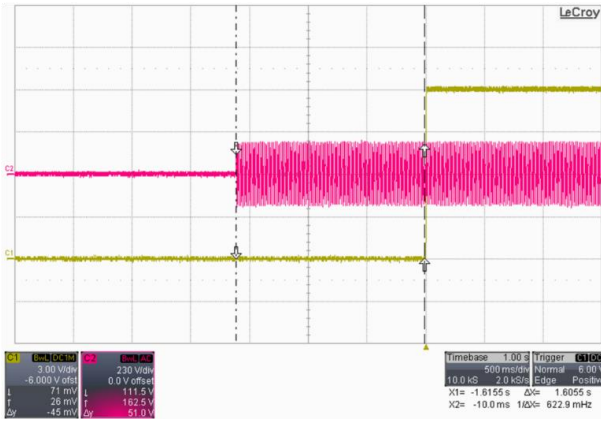

Figure 5. Turn-On AC Line 115 VAC, full load (500 ms/div)
CH1: VO (3 V/div) CH2: Vin (230 V/div)

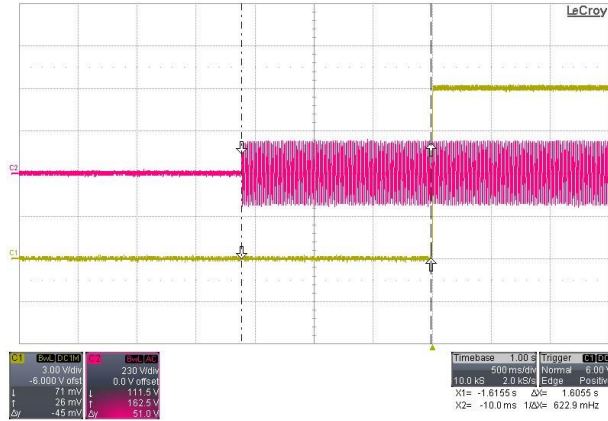

Figure 6. Turn-On AC Line 230 VAC, full load (500 ms/div)
CH1: VO (3 V/div) CH2: Vin (350 V/div)

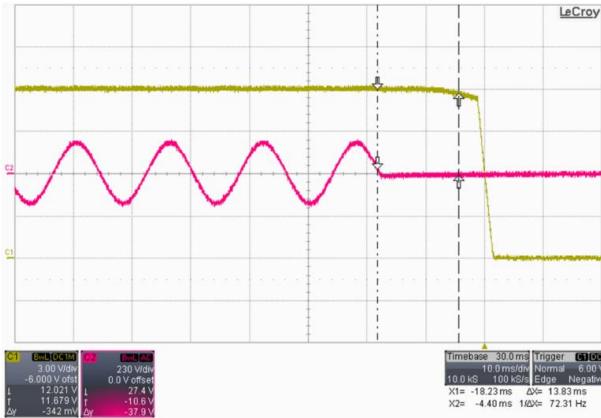

Figure 7. Turn-Off AC Line 115 VAC, full load (10 ms/div)
CH1: VO (3 V/div) CH2: Vin (230 V/div)

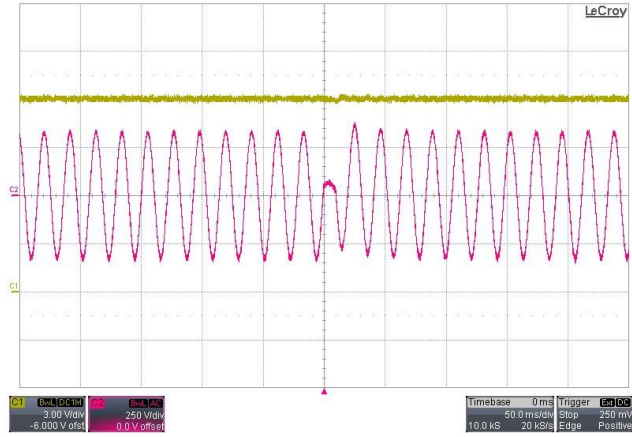

Figure 8. AC drop out 10ms (50 ms/div)
CH1: VO (3 V/div) CH2: Vin (250 V/div)

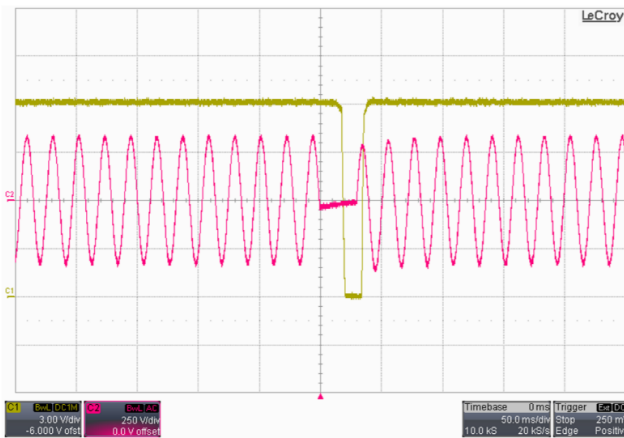

Figure 9. AC drop out 30ms (50 ms/div), VO restart
CH1: VO (3 V/div) CH2: Vin (250 V/div)

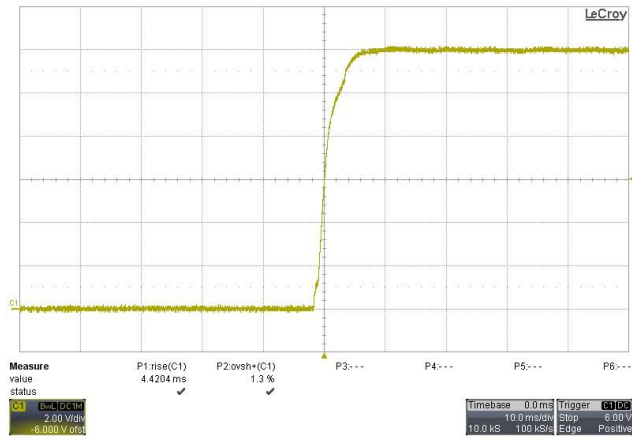

Figure 10. VO rise time at 115VAC CH1: VO (2 V/div)

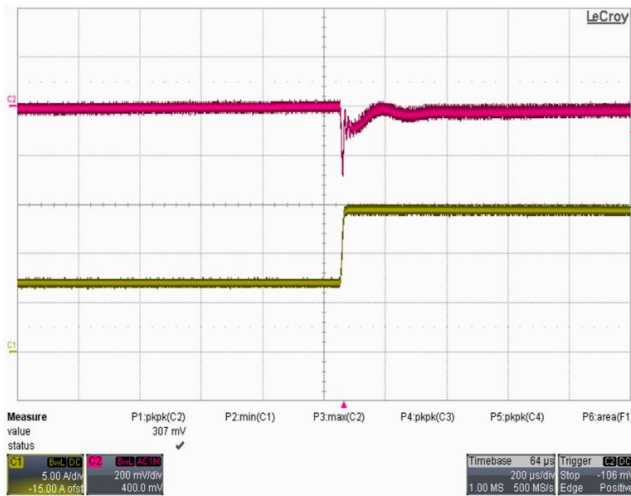

Figure 11. Load transient VO, 7.5A to 15A (200 us/div), CH1: IO (5 A/div) CH2: VO (200 mV/div)

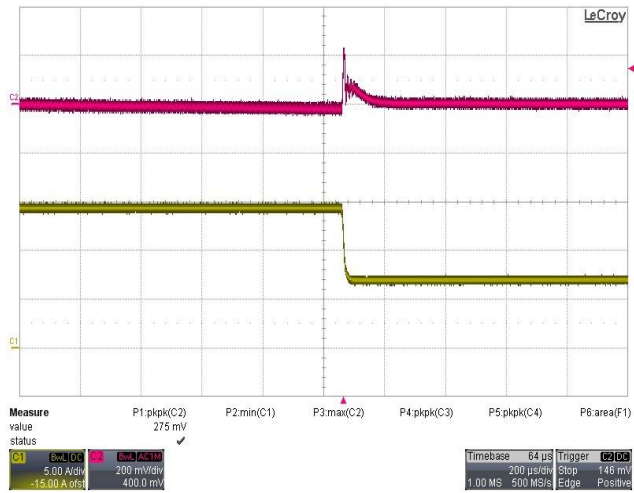

Figure 12. Load transient VO, 15A to 7 A (200 us/div) CH1: IO (5 A/div) CH2: VO (200 mV/div)

6 ENVIRONMENTAL SPECIFICATIONS

PARAMETER	CONDITIONS / DESCRIPTION	MIN	NOM	MAX	UNIT
T_A	Ambient temperature	$V_{i \min}$ to $V_{i \max}$, $I_o \text{ nom}$, $I_{SB \text{ nom}}$			
$T_{A \text{ ext}}$	Extended temp range				
T_S	Storage temperature				

7 PROTECTION

PARAMETER	CONDITIONS / DESCRIPTION	MIN	NOM	MAX	UNIT	
F	Input Fuses Rating	Not user accessible, time lag characteristic				
$V_o \text{ ov}$	OV Trigger Point	ABC200-1012G	14.0	15.0	16.0	VDC
		ABC200-1024G	28.0	30.0	32.0	VDC
		ABC200-1048G	53.0	55.0	57.0	VDC
$I_o \text{ lim}$	Current Limit	$V_i > 90 \text{ VAC}$, $-10 \text{ }^\circ\text{C} < T_a < 50 \text{ }^\circ\text{C}$				
		ABC200-1012G		18.0		A
		ABC200-1024G		9.0		A
	ABC200-1048G		4.5		A	
T_{SD}	Over Temperature on Heat Sinks	Automatic shut-down, automatic recovery after cool down.				
			105		$^\circ\text{C}$	



Asia-Pacific
+86 755 298 85888

Europe, Middle East
+353 61 225 977

North America
+1 408 785 5200

7.1 OVERVOLTAGE PROTECTION

The AC-DC power supply provides a fixed threshold overvoltage (OV) protection implemented with a HW comparator. Once an OV condition has been triggered, the supply will shut down and latch the fault condition. The latch can be unlocked by disconnecting the supply from the AC mains only.

7.2 CURRENT LIMITATION

The main output current limitation will decrease with linear derating to 50% at 70 °C if the ambient (inlet) temperature increases beyond 50 °C (see Figure 13).

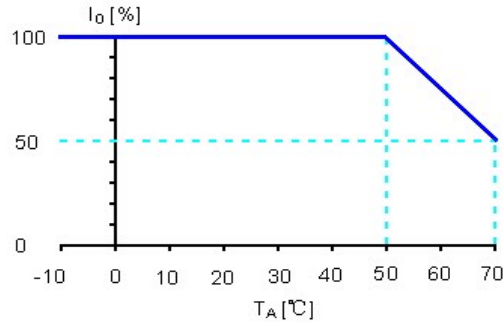
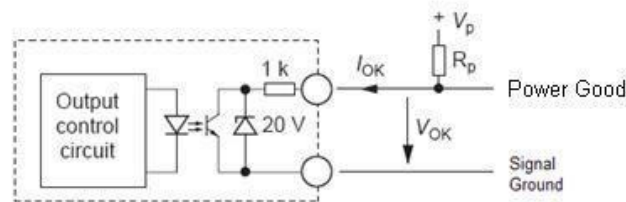

Figure 13. Output Current Capacity Derating

8 POWER GOOD SIGNAL

The Out-OK output gives a status indication of the converter and the output voltages. It can be used for control functions such as data protection, central system monitoring or as a part of a self-testing system. Connecting the Out-OK as shown in Figure 14, $V_{OK} < 1.0$ V indicates the output voltage(s) of the converter are within the range.

Note: Using the potentiometer, the monitor level tracks the programmed output voltage. In an error condition, if the output voltage is out of range due to overload or an external over voltage, V_{OK} will approach V_p . The output is formed by an NPN transistor. The signal is isolated from the output.



O/P V OK - Signal Low, Opto conducting, (max sink current 0.5 mA)

O/P V Bad - Signal High, Opto open, (max leakage current 25 μ A)

Figure 14. Power Good signal

9 ELECTROMAGNETIC COMPATIBILITY

9.1 IMMUNITY

NOTE: Most of the immunity requirements are derived from EN 55024:1998/A2:2003.

TEST	STANDARD / DESCRIPTION	CRITERIA
ESD Contact Discharge	EN 61000-4-2, Level 2	A
RF Susceptibility	EN 61000-4-3, Level 3	A
Fast Transient/Burst	EN 61000-4-4, Level 3	B
Surge	EN 61000-4-5, Class 3	B
RF Conducted Immunity	EN 61000-4-6, Class 3	A
Voltage Dips and Interruptions	EN 61000-4-11	C
Magnetic Fields	EN 61000-4-8, Level 3	A

9.2 EMISSION

TEST	STANDARD / DESCRIPTION	CRITERIA
Conducted Emission	EN55022 / CISPR 22: 0.15 ... 30 MHz, QP and AVG, single unit	Class A
Radiated Emission	EN55022 / CISPR 22: 30 MHz ... 1 GHz, QP, single unit	Class A
Harmonic Emissions	IEC61000-3-2, Vin = 100 VAC/ 60 Hz, 100% Load	Class A
	IEC61000-3-2, Vin = 240 VAC/ 50 Hz, 100% Load	Class A
Voltage Fluctuation and Flicker	EN61000-3-3	PASS

10 SAFETY SPECIFICATIONS

Maximum electric strength testing is performed in the factory according to IEC/EN 60950, and UL 60950. Input-to-output electric strength tests should not be repeated in the field. Bel Power Solutions will not honor any warranty claims resulting from electric strength field tests.

PARAMETER	DESCRIPTION / CONDITIONS	MIN	NOM	MAX	UNIT
Safety Approvals	Safety approved to the latest edition of the following standards: CSA/UL60950-1, EN60950-1 and IEC60950-1. CE Mark for LVD CB Approval				
	Input / Case		Basic		
Insulation Safety Rating	Input / Output		Reinforced		
	Output / Case		Functional		
d_c Creepage / Clearance	Primary (L/N) to protective earth (PE)		According to safety standard		mm
	Primary to secondary				mm
Electrical Strength Test	Input to case		2121		VDC
	Input to output		4242		VDC
	Output and Signals to case		500		VDC



Asia-Pacific
+86 755 298 85888

Europe, Middle East
+353 61 225 977

North America
+1 408 785 5200

11 MECHANICAL SPECIFICATIONS

PARAMETER	CONDITIONS / DESCRIPTION	MIN	NOM	MAX	UNIT
Dimensions	Width		50.8		mm
	Height		36.6		mm
	Depth		101.6		mm
M	Weight		0.2		kg

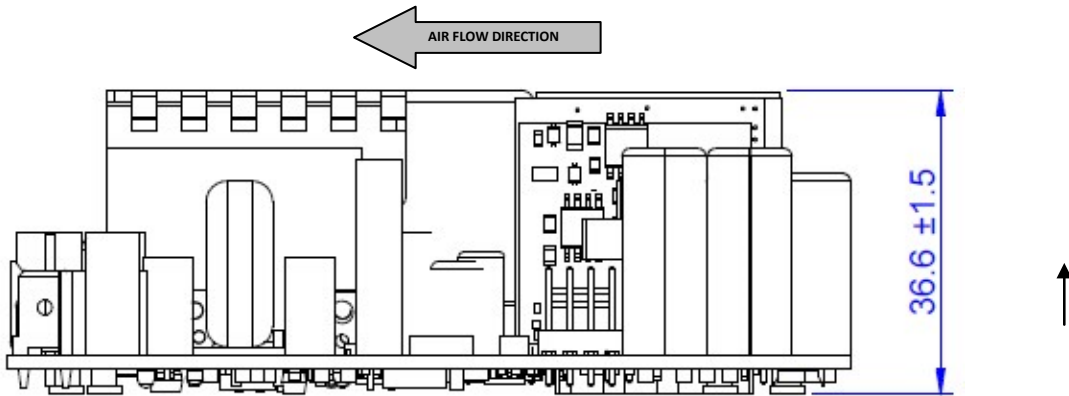

Figure 15. Side view 1

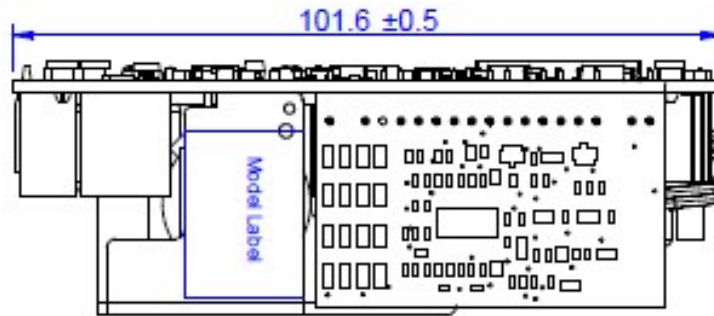

Figure 16. Side view 2

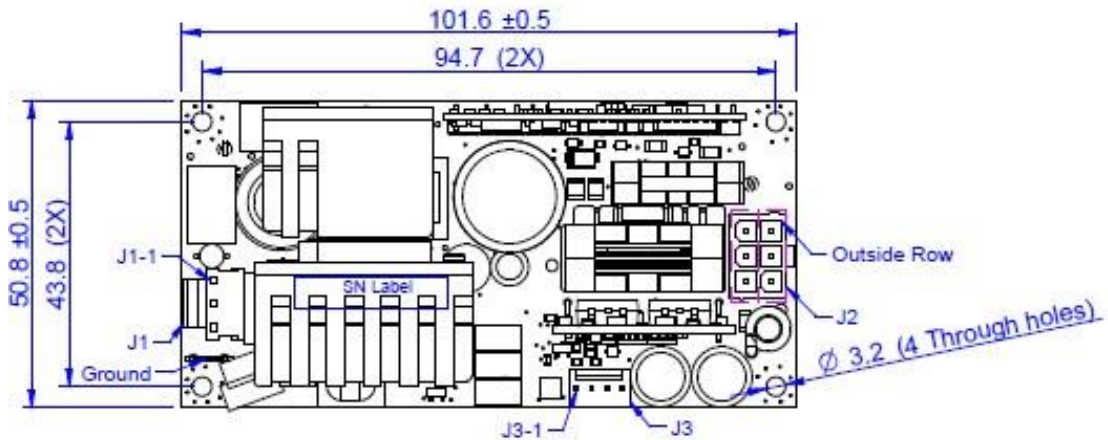

Figure 17. Top view

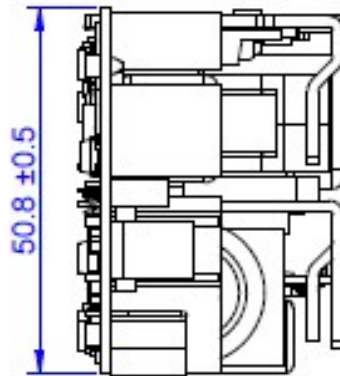

Figure 18. Front view

NOTE: A 3D step file of the power supply casing is available on request.

12 CONNECTIONS

PIN	NAME	DESCRIPTION
Input J1		
J1-1	Live	AC Input Live
J1-2	NA	NA
J1-3	Neutral	AC Input Neutral
Output J2		
Pin 1-3(Insider Row)	-Vo	+12V / +24V / +48V output return
Pin 4-6(Outside Row)	+Vo	+12V / +24V / +48V output
Signal J3		
J3-1	Power Good RTN	Power OK signal output return
J3-2	Power Good	Power OK signal output
J3-3	Vo Sense +	Main output positive sense
J3-4	Vo Sense -	Main output negative sense

For more information on these products consult: tech.support@psbel.com

NUCLEAR AND MEDICAL APPLICATIONS - Products are not designed or intended for use as critical components in life support systems, equipment used in hazardous environments, or nuclear control systems.

TECHNICAL REVISIONS - The appearance of products, including safety agency certifications pictured on labels, may change depending on the date manufactured. Specifications are subject to change without notice.



Asia-Pacific
+86 755 298 85888

Europe, Middle East
+353 61 225 977

North America
+1 408 785 5200

Компания «Life Electronics» занимается поставками электронных компонентов импортного и отечественного производства от производителей и со складов крупных дистрибьюторов Европы, Америки и Азии.

С конца 2013 года компания активно расширяет линейку поставок компонентов по направлению коаксиальный кабель, кварцевые генераторы и конденсаторы (керамические, пленочные, электролитические), за счёт заключения дистрибьюторских договоров

Мы предлагаем:

- Конкурентоспособные цены и скидки постоянным клиентам.
- Специальные условия для постоянных клиентов.
- Подбор аналогов.
- Поставку компонентов в любых объемах, удовлетворяющих вашим потребностям.
- Приемлемые сроки поставки, возможна ускоренная поставка.
- Доставку товара в любую точку России и стран СНГ.
- Комплексную поставку.
- Работу по проектам и поставку образцов.
- Формирование склада под заказчика.
- Сертификаты соответствия на поставляемую продукцию (по желанию клиента).
- Тестирование поставляемой продукции.
- Поставку компонентов, требующих военную и космическую приемку.
- Входной контроль качества.
- Наличие сертификата ISO.

В составе нашей компании организован Конструкторский отдел, призванный помогать разработчикам, и инженерам.

Конструкторский отдел помогает осуществить:

- Регистрацию проекта у производителя компонентов.
- Техническую поддержку проекта.
- Защиту от снятия компонента с производства.
- Оценку стоимости проекта по компонентам.
- Изготовление тестовой платы монтаж и пусконаладочные работы.



Тел: +7 (812) 336 43 04 (многоканальный)
Email: org@lifeelectronics.ru