

Trench gate field-stop IGBT, HB series 650 V, 40 A high speed

Datasheet - production data

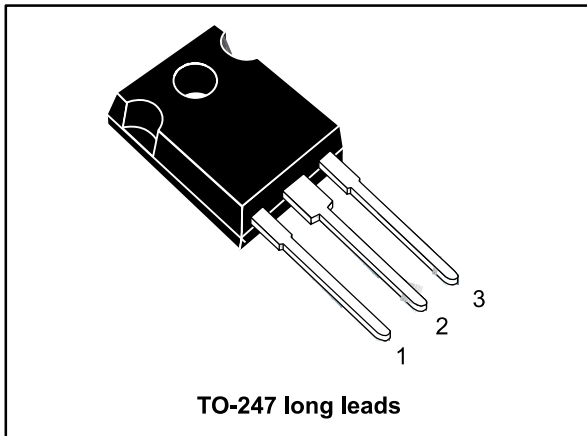
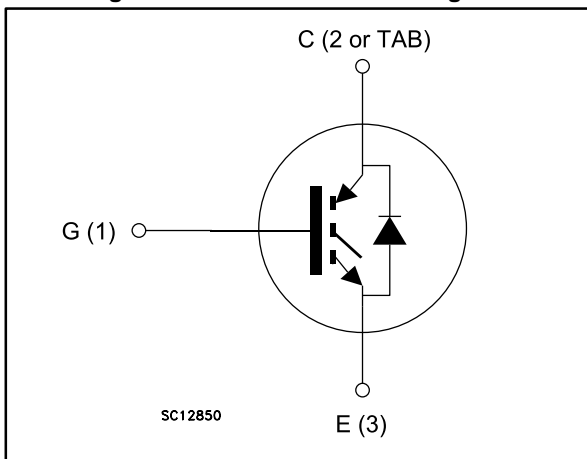

Figure 1: Internal schematic diagram



Features

- Maximum junction temperature: $T_J = 175\text{ }^\circ\text{C}$
- High speed switching series
- Minimized tail current
- Low saturation voltage: $V_{CE(sat)} = 1.6\text{ V (typ.)}$ @ $I_C = 40\text{ A}$
- Tight parameter distribution
- Safe paralleling
- Low thermal resistance
- Very fast soft recovery antiparallel diode

Applications

- Photovoltaic inverters
- High frequency converters

Description

This device is an IGBT developed using an advanced proprietary trench gate field-stop structure. The device is part of the new HB series of IGBTs, which represents an optimum compromise between conduction and switching loss to maximize the efficiency of any frequency converter. Furthermore, the slightly positive $V_{CE(sat)}$ temperature coefficient and very tight parameter distribution result in safer paralleling operation.

Table 1: Device summary

Order code	Marking	Package	Packing
STGWA40H65DFB	G40H65DFB	TO-247 long leads	Tube

Contents

1	Electrical ratings	3
2	Electrical characteristics	4
	2.1 Electrical characteristics (curves)	7
3	Test circuits	13
4	Package mechanical data	14
	4.1 TO-247 long lead package information	14
5	Revision history	16

1 Electrical ratings

Table 2: Absolute maximum ratings

Symbol	Parameter	Value	Unit
V_{CES}	Collector-emitter voltage ($V_{GE} = 0$)	650	V
I_C	Continuous collector current at $T_C = 25\text{ °C}$	80	A
	Continuous collector current at $T_C = 100\text{ °C}$	40	
$I_{CP}^{(1)}$	Pulsed collector current	160	A
V_{GE}	Gate-emitter voltage	± 20	V
I_F	Continuous forward current at $T_C = 25\text{ °C}$	80	A
	Continuous forward current at $T_C = 100\text{ °C}$	40	
$I_{FP}^{(1)}$	Pulsed forward current	160	A
P_{TOT}	Total dissipation at $T_C = 25\text{ °C}$	283	W
T_{STG}	Storage temperature range	- 55 to 150	°C
T_J	Operating junction temperature range	- 55 to 175	

Notes:

⁽¹⁾Pulse width limited by maximum junction temperature.

Table 3: Thermal data

Symbol	Parameter	Value	Unit
R_{thJC}	Thermal resistance junction-case IGBT	0.53	°C/W
R_{thJC}	Thermal resistance junction-case diode	1.14	
R_{thJA}	Thermal resistance junction-ambient	50	

2 Electrical characteristics

$T_C = 25\text{ °C}$ unless otherwise specified

Table 4: Static characteristics

Symbol	Parameter	Test conditions	Min.	Typ.	Max.	Unit
$V_{(BR)CES}$	Collector-emitter breakdown voltage	$V_{GE} = 0\text{ V}$, $I_C = 2\text{ mA}$	650			V
$V_{CE(sat)}$	Collector-emitter saturation voltage	$V_{GE} = 15\text{ V}$, $I_C = 40\text{ A}$		1.6	2	V
		$V_{GE} = 15\text{ V}$, $I_C = 40\text{ A}$, $T_J = 125\text{ °C}$		1.7		
		$V_{GE} = 15\text{ V}$, $I_C = 40\text{ A}$, $T_J = 175\text{ °C}$		1.8		
V_F	Forward on-voltage	$I_F = 40\text{ A}$		1.7	2.45	V
		$I_F = 40\text{ A}$, $T_J = 125\text{ °C}$		1.4		
		$I_F = 40\text{ A}$, $T_J = 175\text{ °C}$		1.3		
$V_{GE(th)}$	Gate threshold voltage	$V_{CE} = V_{GE}$, $I_C = 1\text{ mA}$	5	6	7	V
I_{CES}	Collector cut-off current	$V_{GE} = 0\text{ V}$, $V_{CE} = 650\text{ V}$			25	μA
I_{GES}	Gate-emitter leakage current	$V_{CE} = 0\text{ V}$, $V_{GE} = \pm 20\text{ V}$			± 250	nA

Table 5: Dynamic characteristics

Symbol	Parameter	Test conditions	Min.	Typ.	Max.	Unit
C_{ies}	Input capacitance	$V_{CE} = 25\text{ V}$, $f = 1\text{ MHz}$, $V_{GE} = 0\text{ V}$	-	5412	-	pF
C_{oes}	Output capacitance		-	198	-	
C_{res}	Reverse transfer capacitance		-	107	-	
Q_g	Total gate charge	$V_{CC} = 520\text{ V}$, $I_C = 40\text{ A}$, $V_{GE} = 15\text{ V}$ (see Figure 29: "Gate charge test circuit")	-	210	-	nC
Q_{ge}	Gate-emitter charge		-	39	-	
Q_{gc}	Gate-collector charge		-	82	-	

Table 6: IGBT switching characteristics (inductive load)

Symbol	Parameter	Test conditions	Min.	Typ.	Max.	Unit
$t_{d(on)}$	Turn-on delay time	$V_{CE} = 400\text{ V}$, $I_C = 40\text{ A}$, $V_{GE} = 15\text{ V}$, $R_G = 5\text{ }\Omega$ (see Figure 28: "Test circuit for inductive load switching")		40	-	ns
t_r	Current rise time			13	-	
$(di/dt)_{on}$	Turn-on current slope			2413	-	A/ μs
$t_{d(off)}$	Turn-off-delay time			142	-	ns
t_f	Current fall time			27	-	

Symbol	Parameter	Test conditions	Min.	Typ.	Max.	Unit
$E_{on}^{(1)}$	Turn-on switching energy			498	-	μJ
$E_{off}^{(2)}$	Turn-off switching energy			363	-	
E_{ts}	Total switching energy			861	-	
$t_{d(on)}$	Turn-on delay time	$V_{CE} = 400\text{ V}$, $I_C = 40\text{ A}$, $V_{GE} = 15\text{ V}$, $R_G = 5\ \Omega$, $T_J = 175\text{ }^\circ\text{C}$ (see Figure 28: "Test circuit for inductive load switching")		38	-	ns
t_r	Current rise time			14	-	
$(di/dt)_{on}$	Turn-on current slope			2186	-	$\text{A}/\mu\text{s}$
$t_{d(off)}$	Turn-off-delay time			141	-	ns
t_f	Current fall time			61	-	
$E_{on}^{(1)}$	Turn-on switching energy			1417	-	μJ
$E_{off}^{(2)}$	Turn-off switching energy			764	-	
E_{ts}	Total switching energy			2181	-	

Notes:

(1)Including the reverse recovery of the diode.

(2)Including the tail of the collector current.

Table 7: Diode switching characteristics (inductive load)

Symbol	Parameter	Test conditions	Min.	Typ.	Max.	Unit
t_{rr}	Reverse recovery time	$I_F = 40\text{ A}$, $V_R = 400\text{ V}$, $V_{GE} = 15\text{ V}$, $di/dt = 100\text{ A}/\mu\text{s}$ (see Figure 28: "Test circuit for inductive load switching")	-	62	-	ns
Q_{rr}	Reverse recovery charge		-	99	-	nC
I_{rrm}	Reverse recovery current		-	3.3	-	A
dl_{rr}/dt	Peak rate of fall of reverse recovery current during t_b		-	187	-	$\text{A}/\mu\text{s}$
E_{rr}	Reverse recovery energy		-	68	-	μJ
t_{rr}	Reverse recovery time	$I_F = 40\text{ A}$, $V_R = 400\text{ V}$, $V_{GE} = 15\text{ V}$, $T_J = 175\text{ }^\circ\text{C}$, $di/dt = 100\text{ A}/\mu\text{s}$	-	310	-	ns

Symbol	Parameter	Test conditions	Min.	Typ.	Max.	Unit
Q_{rr}	Reverse recovery charge	(see Figure 28: "Test circuit for inductive load switching")	-	1550	-	nC
I_{rrm}	Reverse recovery current		-	10	-	A
di_{rr}/dt	Peak rate of fall of reverse recovery current during t_b		-	70	-	A/ μ s
E_{rr}	Reverse recovery energy		-	674	-	μ J

2.1 Electrical characteristics (curves)

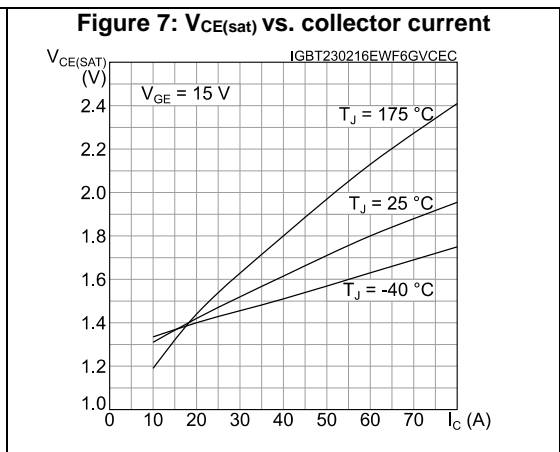
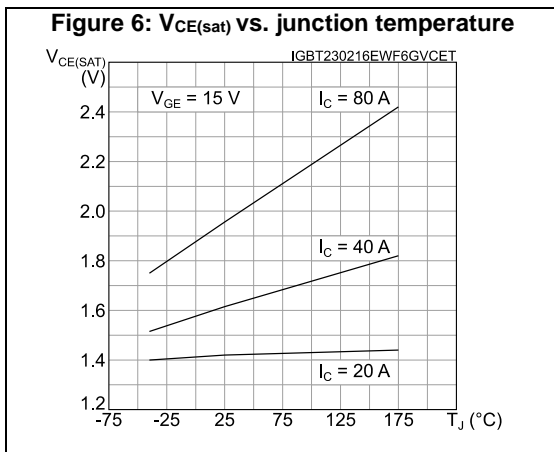
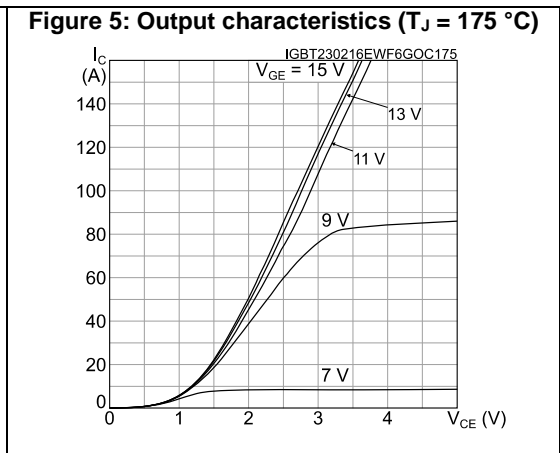
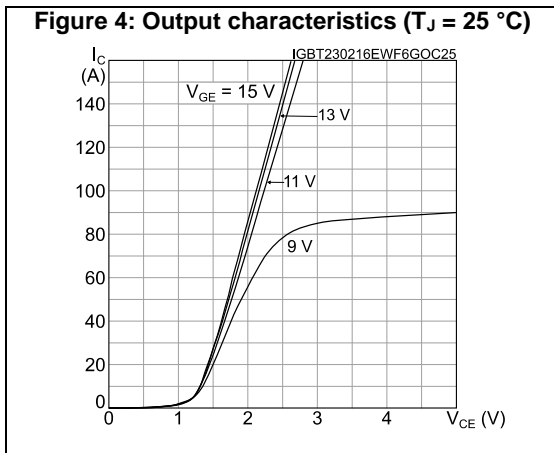
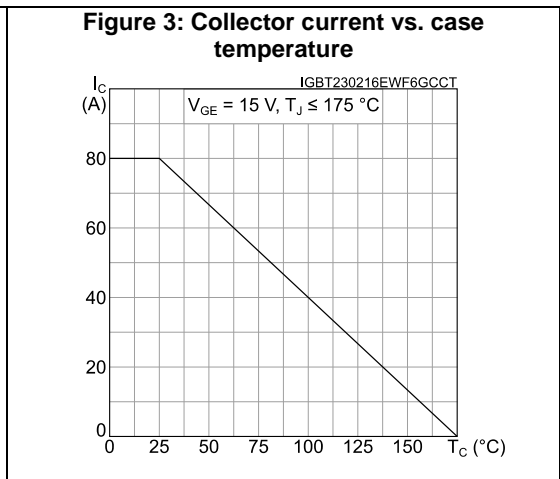
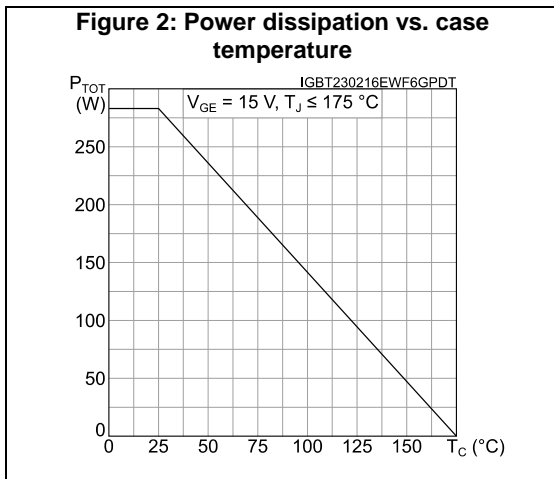

Figure 8: Collector current vs. switching frequency

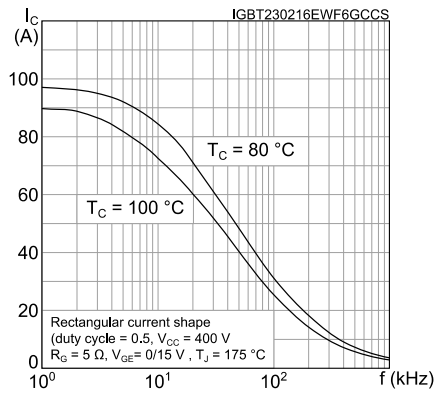

Figure 9: Forward bias safe operating area

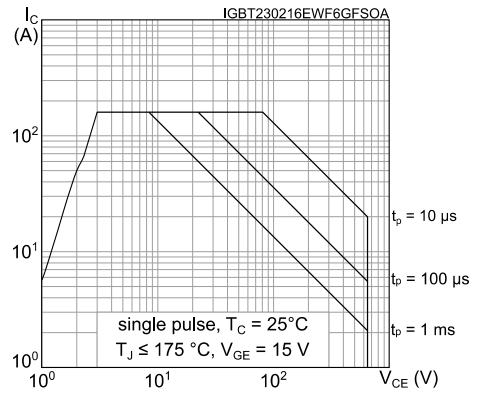

Figure 10: Transfer characteristics

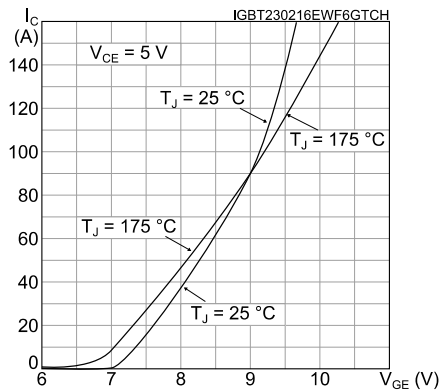

Figure 11: Diode Vf vs. forward current

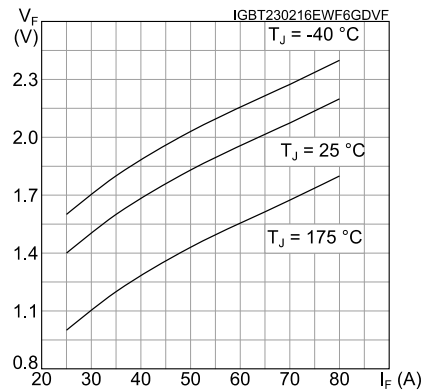

Figure 12: Normalized VGE(th) vs. junction temperature

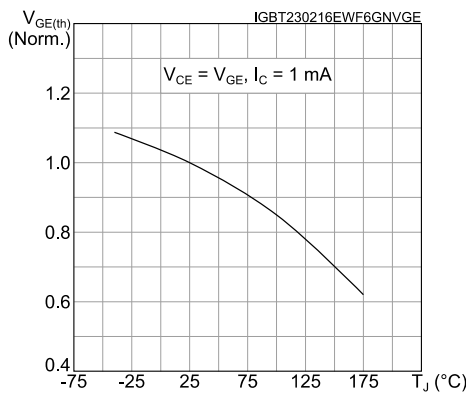
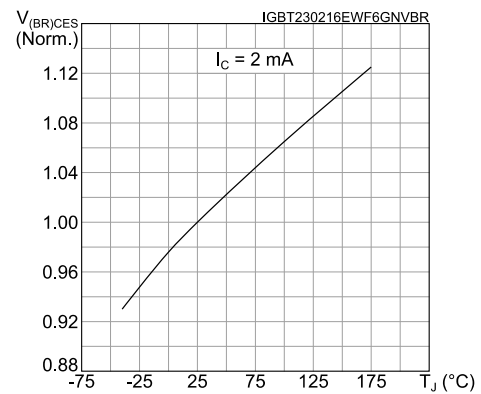
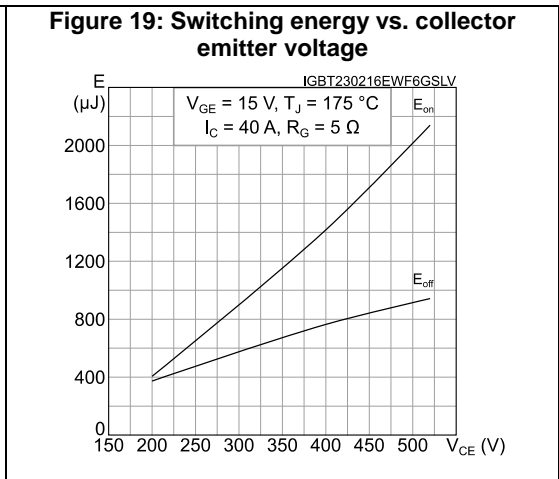
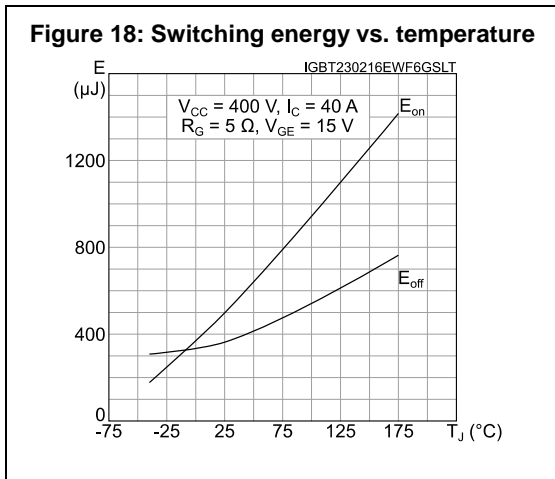
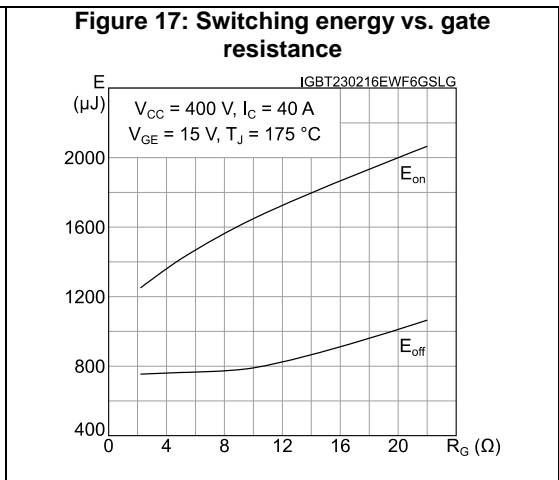
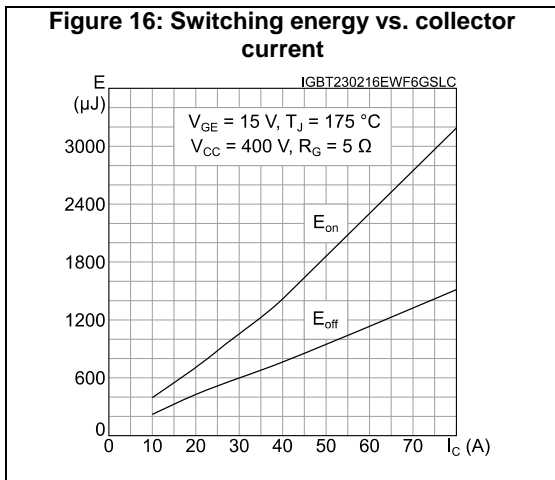
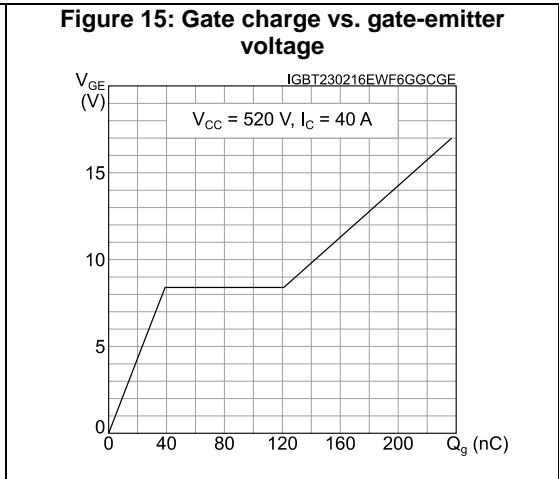
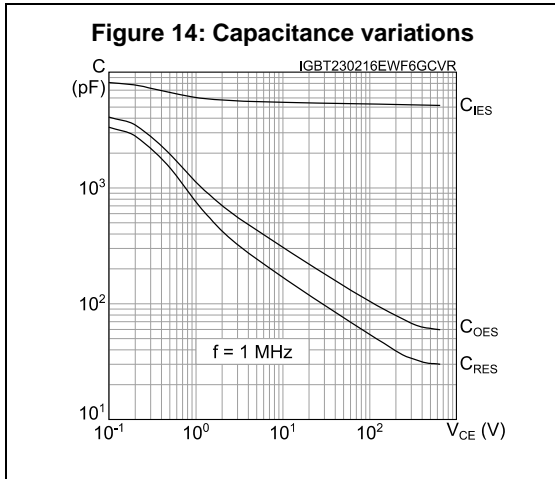

Figure 13: Normalized V(BR)CES vs. junction temperature





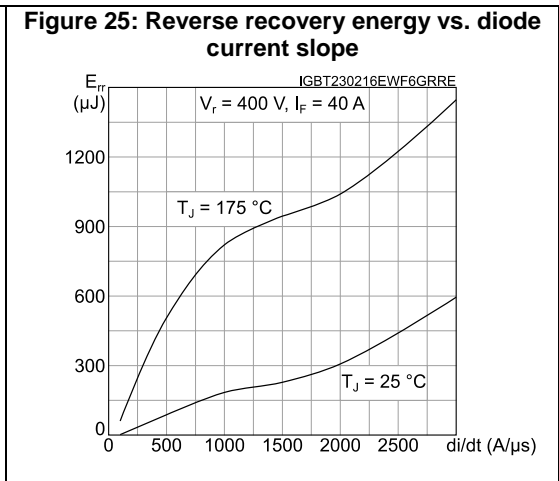
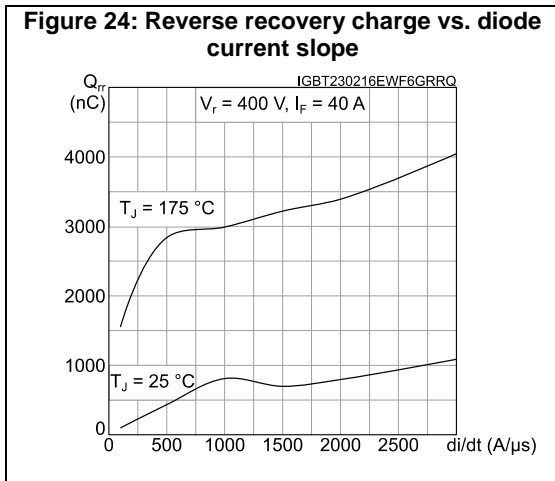
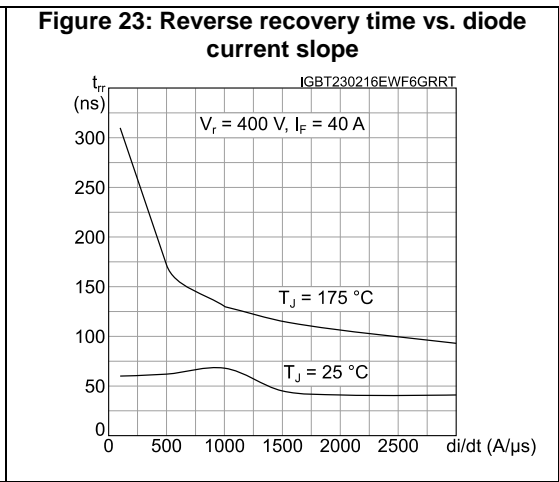
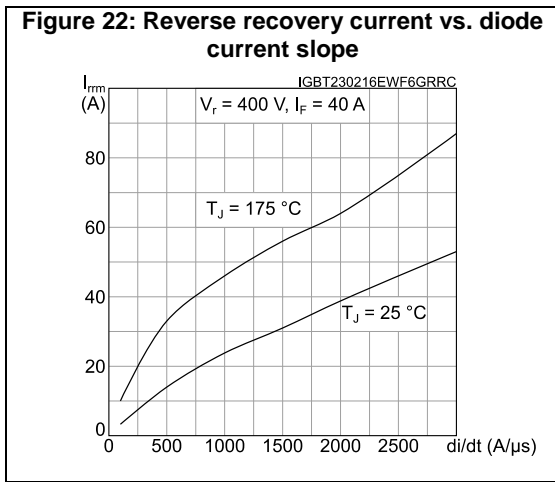
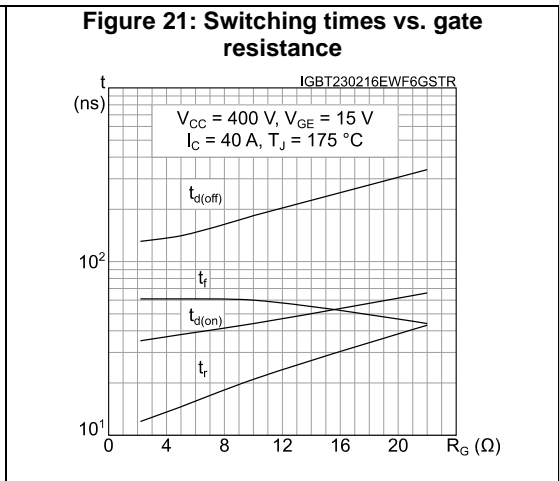
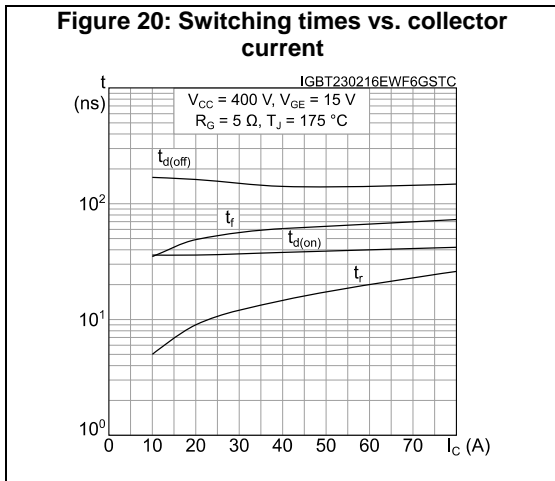
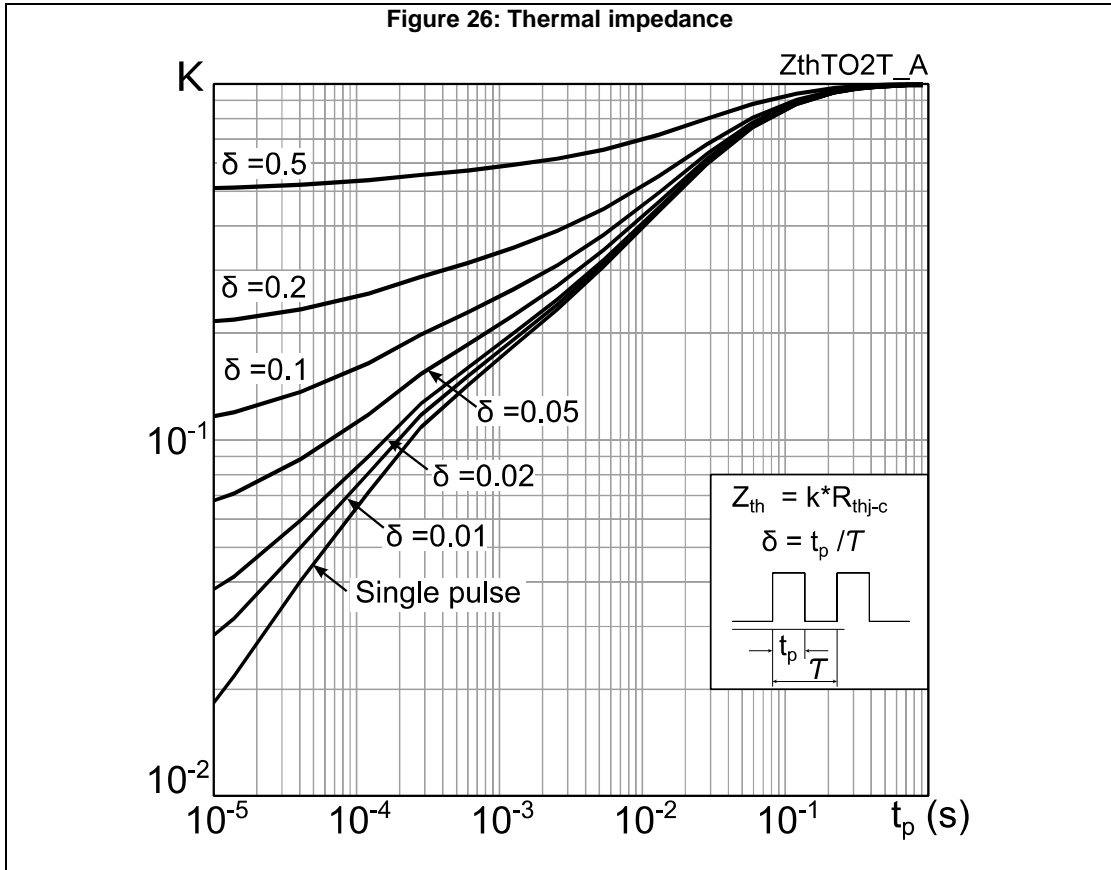
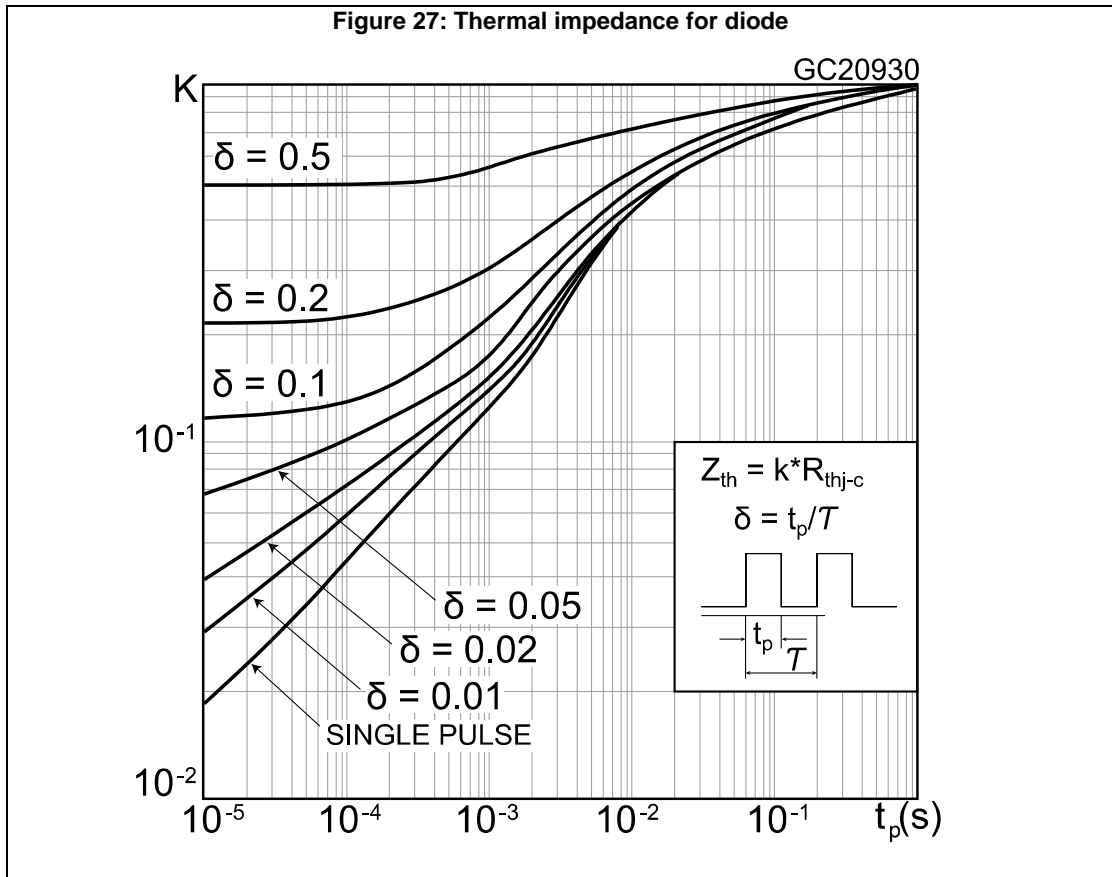

Figure 26: Thermal impedance





4 Package mechanical data

In order to meet environmental requirements, ST offers these devices in different grades of ECOPACK® packages, depending on their level of environmental compliance. ECOPACK® specifications, grade definitions and product status are available at: www.st.com. ECOPACK® is an ST trademark.

4.1 TO-247 long lead package information

Figure 32: TO-247 long lead package outline

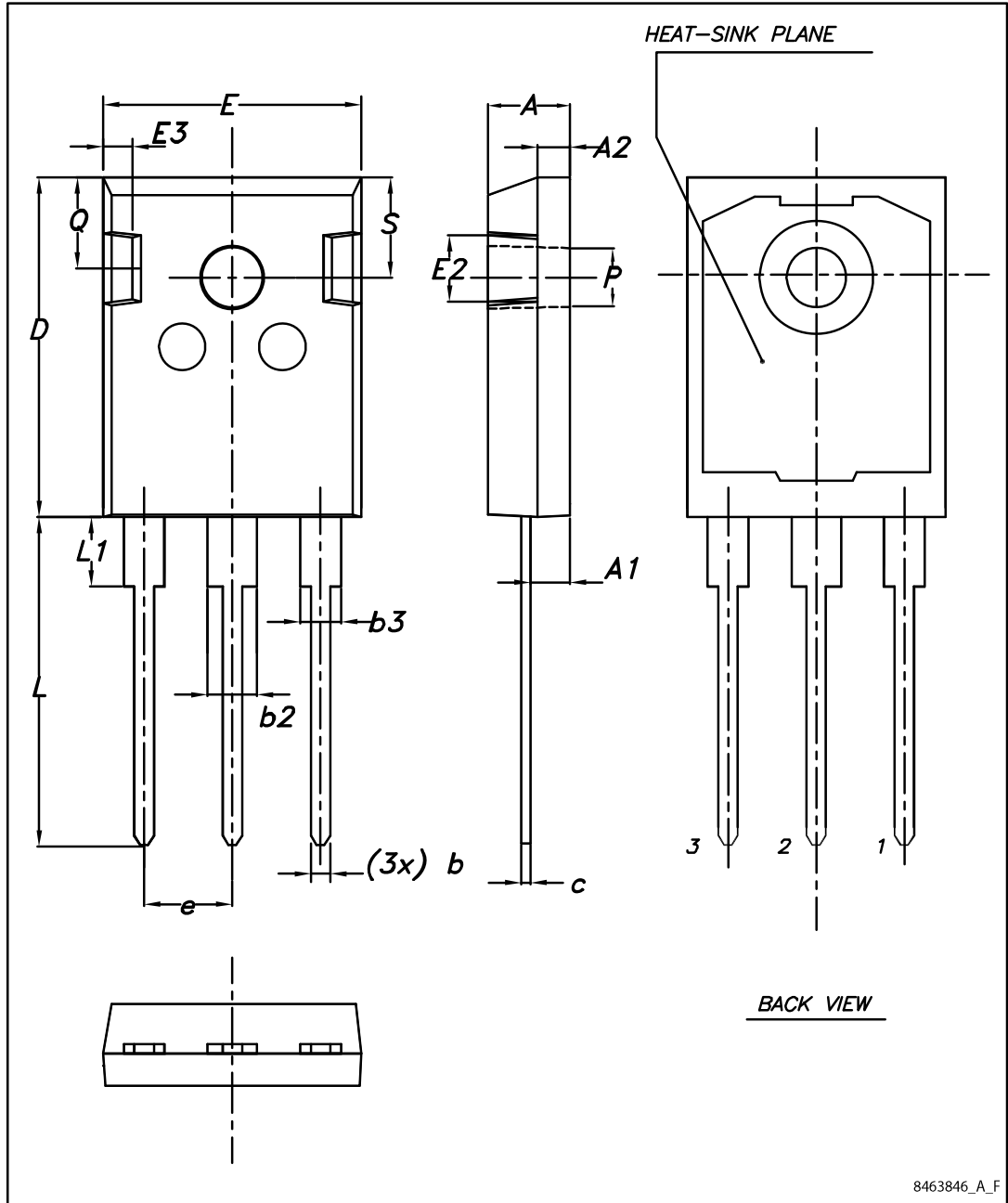

8463846_A_F

Table 8: TO-247 long lead package mechanical data

Dim.	mm		
	Min.	Typ.	Max.
A	4.90	5.00	5.10
A1	2.31	2.41	2.51
A2	1.90	2.00	2.10
b	1.16		1.26
b2			3.25
b3			2.25
c	0.59		0.66
D	20.90	21.00	21.10
E	15.70	15.80	15.90
E2	4.90	5.00	5.10
E3	2.40	2.50	2.60
e	5.34	5.44	5.54
L	19.80	19.92	20.10
L1			4.30
P	3.50	3.60	3.70
Q	5.60		6.00
S	6.05	6.15	6.25

5 Revision history

Table 9: Document revision history

Date	Revision	Changes
06-Jun-2016	1	Initial version. Part number previously included in datasheet DocID024363.

IMPORTANT NOTICE – PLEASE READ CAREFULLY

STMicroelectronics NV and its subsidiaries ("ST") reserve the right to make changes, corrections, enhancements, modifications, and improvements to ST products and/or to this document at any time without notice. Purchasers should obtain the latest relevant information on ST products before placing orders. ST products are sold pursuant to ST's terms and conditions of sale in place at the time of order acknowledgement.

Purchasers are solely responsible for the choice, selection, and use of ST products and ST assumes no liability for application assistance or the design of Purchasers' products.

No license, express or implied, to any intellectual property right is granted by ST herein.

Resale of ST products with provisions different from the information set forth herein shall void any warranty granted by ST for such product.

ST and the ST logo are trademarks of ST. All other product or service names are the property of their respective owners.

Information in this document supersedes and replaces information previously supplied in any prior versions of this document.

© 2016 STMicroelectronics – All rights reserved

Компания «Life Electronics» занимается поставками электронных компонентов импортного и отечественного производства от производителей и со складов крупных дистрибьюторов Европы, Америки и Азии.

С конца 2013 года компания активно расширяет линейку поставок компонентов по направлению коаксиальный кабель, кварцевые генераторы и конденсаторы (керамические, пленочные, электролитические), за счёт заключения дистрибьюторских договоров

Мы предлагаем:

- Конкурентоспособные цены и скидки постоянным клиентам.
- Специальные условия для постоянных клиентов.
- Подбор аналогов.
- Поставку компонентов в любых объемах, удовлетворяющих вашим потребностям.
- Приемлемые сроки поставки, возможна ускоренная поставка.
- Доставку товара в любую точку России и стран СНГ.
- Комплексную поставку.
- Работу по проектам и поставку образцов.
- Формирование склада под заказчика.
- Сертификаты соответствия на поставляемую продукцию (по желанию клиента).
- Тестирование поставляемой продукции.
- Поставку компонентов, требующих военную и космическую приемку.
- Входной контроль качества.
- Наличие сертификата ISO.

В составе нашей компании организован Конструкторский отдел, призванный помогать разработчикам, и инженерам.

Конструкторский отдел помогает осуществить:

- Регистрацию проекта у производителя компонентов.
- Техническую поддержку проекта.
- Защиту от снятия компонента с производства.
- Оценку стоимости проекта по компонентам.
- Изготовление тестовой платы монтаж и пусконаладочные работы.



Тел: +7 (812) 336 43 04 (многоканальный)

Email: org@lifeelectronics.ru