

# Microwave cable assemblies

Edition 2018/06



Create reliability and high performance





General assembly information	4	General information
Qualified, high performance microwave cable assemblies > SUCOFLEX 100/200/300 /400/500	8	High performance
Qualified, low profile, high performance microwave cable assemblies > Minibend family	86	Low profile assemblies
Microwave test cable assemblies > Sucotest/TL-8A/TL-P	114	Test assemblies
Flexible microwave cable assemblies > Boa-flex/Steel-flex/Multiflex/S-Series	128	Flexible assemblies
Formstable and handformable microwave cables assemblies > Sucoform/Cobra-flex/Semi-rigid	164	Formstable assemblies
Engineering information	180	Engineering information
Selection guide	190	Selection guide

#### Your partner for system solutions

HUBER+SUHNER makes a significant contribution to simplifying processes by supplying cables assembled with connector according to customer requirements. The assemblies are manufactured using high-quality cables and connectors, carefully tested according to the relevant standards and delivered with a certificate upon request.

# General assembly information

## Cables and connectors from the same manufacturer

HUBER+SUHNER develops and manufactures coaxial cables and connectors for most applications and in a multitude of versions. The connector series comprise over 1700 different types which prove their qualities daily worldwide. Demanding customers trust the reliability and quality of HUBER+SUHNER products. These products have been tested to IEC, MIL, CECC and other standards. Our extensive know-how in RF technology enables reliable and competent technical consulting and support. You stand to benefit from a well matched cable and connector range as well as many years vast experience of our engineers.



## Microwave cable assemblies to your specifications

Make use of the HUBER+SUHNER custom design service. Increase efficiency and productivity in your company by ordering ready-to-use microwave cable assemblies from the specialists. Expert assembly by soldering, clamp or crimp technique and inspection records according to your specifications enable you to order with confidence.

## Advantages of microwave cable assemblies

Purchasing of ready-made microwave cable assembly lines provides important benefits:

- Perfect assembly, no rejects
- No need for training assembly personnel
- No capital investment for assembly provisions
- Precisely matched cables and connectors from the same manufacturer
- HUBER+SUHNER guarantees quality

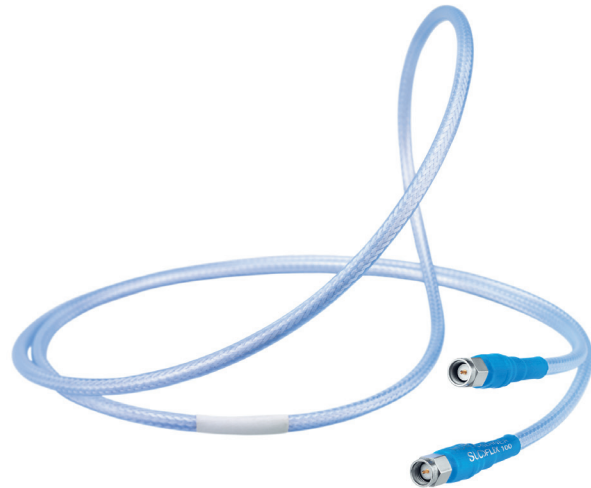



# General assembly information

## Assembly shop capability

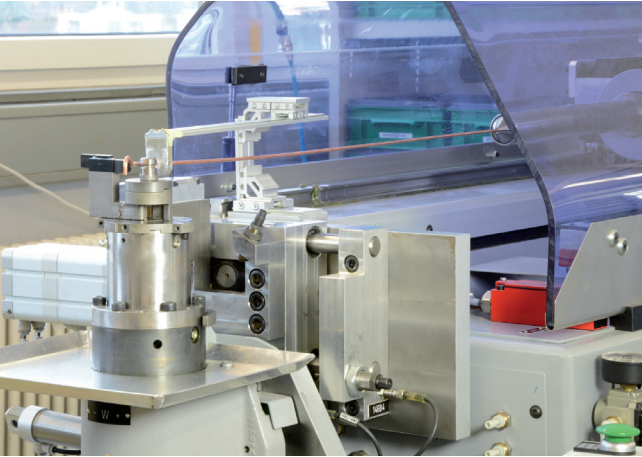

Automatic bending

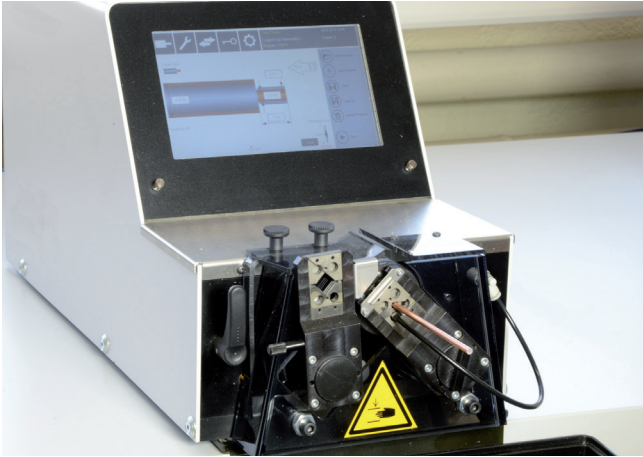

Automatic stripping

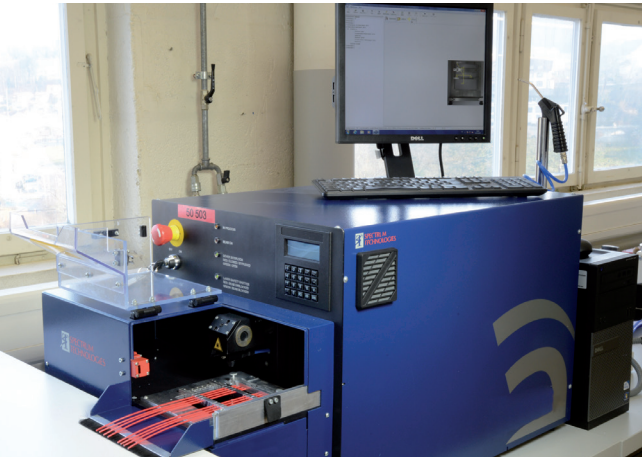

Automatic laser stripping



Temperature controlled soldering



Clean room

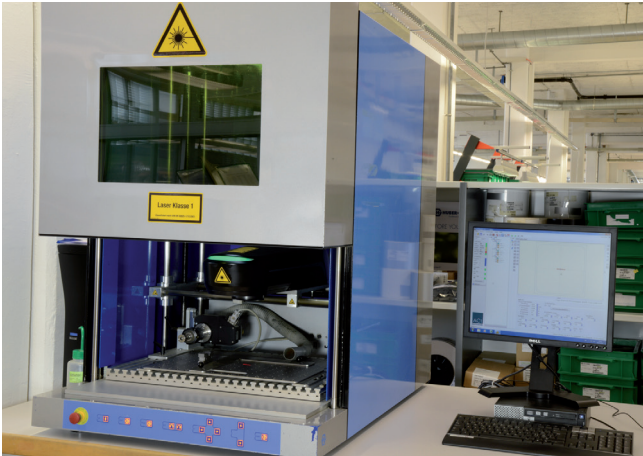

Laser marking

# General assembly information

## Length definition and assembly design

The assembly lengths are measured using the connector reference plane of straight plug and jack connectors and the pin center-line of right angle connectors.

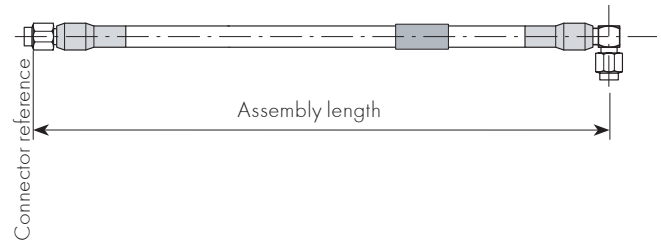
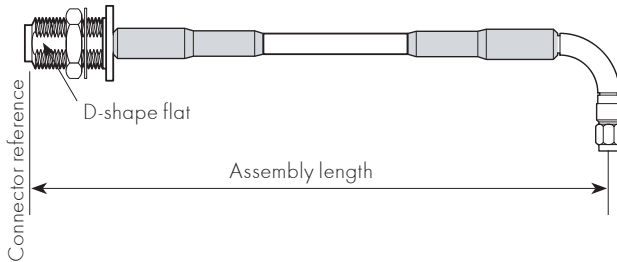

## Standard assembly length tolerances

### SUCOFLEX®, Sucotest

≤ 200 mm	± 1.0 mm
> 200 mm	± 0.5 %

### Minibend

± 7.1 mm
----------

### Multiflex and S-series

≤ 500 mm	± 5.0 mm
≤ 1000 mm	± 7.0 mm
≤ 2000 mm	± 12.0 mm
> 2000 mm	± 0.6 %

### Sucoform

≤ 500 mm	± 3.0 mm
≤ 1000 mm	± 5.0 mm
≤ 2000 mm	± 8.0 mm
> 2000 mm	± 0.4 %

### Semi-rigid, Boa-flex, Ever-flex, Steel-flex, Cobra-flex

≤ 500 mm	± 2.0 mm
≤ 1000 mm	± 3.0 mm
≤ 2000 mm	± 5.0 mm
> 2000 mm	± 0.3 %

Tighter assembly tolerances are available on special request. Please ask your local HUBER+SUHNER partner.

## Angular displacement and D-shape flat of connectors

With HUBER+SUHNER microwave cable assemblies that have right angle or right angle and bulkhead connectors the relative angular displacement must be specified as shown in the following sketches.

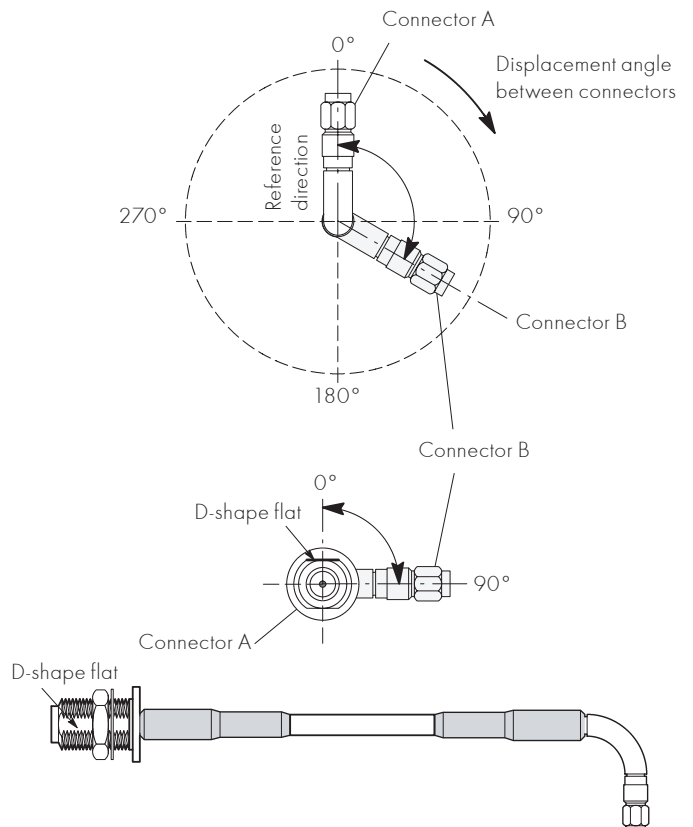

# General assembly information

## Care and handling instructions

HUBER+SUHNER microwave cable assemblies of all types offer a long service life providing they are treated with the appropriate care and attention. Microwave cable assemblies are high precision system components and require proper handling in order to ensure that measured performance values are maintained.

To achieve the maximum installed performance the following guidelines should be followed:

1. Assemblies should remain in their original packaging for delivery and storage. Storage temperature should be between  $-50$  and  $+80$  °C and the relative humidity should not exceed 85 %.
2. Carefully unpack assemblies before installation. Avoid kinking cables when straightening from a coil or reel.
3. Ensure that the surroundings are clean and free of dust, dirt and any other particles that could enter unsealed connector interfaces.
4. Use protective caps to prevent contamination whenever connectors are unmated.
5. Where interfaces are contaminated, particles can be removed with dry, oil-free compressed air. Please use eye-protection. Interfaces can be cleaned with dry cotton swabs. Do not use hard handtools or solvents. Do not blow into interfaces or use normal compressed-air.
6. Choose the installation routing using the largest bend radii possible. Small bend radii may affect electrical performance. Exceeding the specified limits during the installation process could cause a permanent degradation.
7. Avoid twisting microwave cable assemblies. Torsion of this type of assembly can alter the relative diameters of cable layers and affects the electrical characteristics. Exceeding the limit of  $10^\circ$  per metre during installation process could cause a permanent degradation.
8. Assemblies should be fixed in place without excess pressure. The use of cable ties should be avoided where possible, as they can easily exert more force than this. If cable ties must be used then they should be as wide as possible and still allow movement of the cable. Avoid placing fixings at regular intervals.
9. Examine interfaces for damage and/or contamination before mating.
10. Discharge connectors before mating or ensure that they are connected to a suitable ground.
11. When mating connectors with a screwed interface always hold the connector bodies and turn only the coupling nut. This avoids twisting the cable and ensures minimum wear on the connector pins.
12. Do not exceed the specified torque.



## Qualified, high performance microwave cable assemblies

The flexible SUCOFLEX® series microwave cable assemblies offer superior electrical and mechanical performance for static and dynamic applications. This series is a high-end product designed to provide optimal performance up to 50 GHz, where stringent electrical requirements, in particular electrical stability and low loss, are important. Ideally suited for test and measurement applications and defense systems. Additional lightweight high end versions are designed to meet the stringent needs of space flights systems (i. e. satellites) and aerospace systems (aircrafts, helicopters, missiles), which are subject to extremely severe operating conditions. SUCOFLEX is only available as assembly.





## SUCOFLEX®

- Introduction
- Advantages
- Overview
- Qualifications

page 10



## SUCOFLEX 100

The low loss, high performance microwave cable assembly

- For static and dynamic applications up to 50 GHz
- Excellent return loss
- A balanced range of connectors is available, including types which feature NWA-specific interfaces, and can be provided with various ruggedisations to protect the assembly against different environmental influences
- Stock assemblies available

page 15

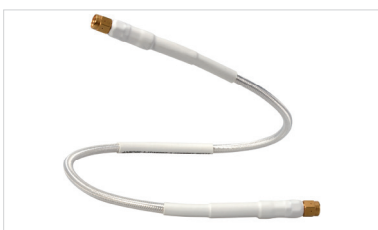

## SUCOFLEX 200

The loss revolution for dynamic applications

- For static and dynamic applications up to 40 GHz
- Ultra low loss
- Outstanding phase stability vs. temperature
- Excellent return loss
- Stock assemblies available

page 42



## SUCOFLEX 300

The light weight, low loss microwave cable assemblies

- SUCOFLEX 300 series offers a consistently outstanding mechanical and electrical performance, stability and reliability up to 40 GHz
- Weight reduction of up to 40 % compared to our conventional products
- Assemblies produced in a clean environment room

page 50

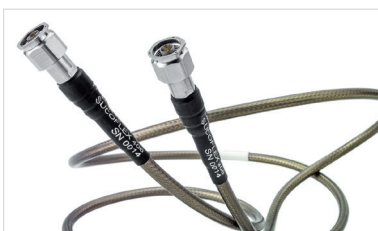

## SUCOFLEX 400

The ultra low loss, temperature phase stable microwave cable assemblies

- Best insertion loss on the market up to 26.5 GHz
- High phase stability versus temperature
- Excellent return loss
- Improved system performance in case of reduced phase change over temperature
- Higher signal integrity due to lower loss

page 70



## SUCOFLEX 500

When it comes to test and measurement, SUCOFLEX 500 assemblies guarantee the highest level of satisfaction

- Torque, crush and kink resistant
- Precise and repeatable measurements
- Long service life
- Reduce total cost of test with durable, reliable performance
- Increased test and measurement efficiency saving costs due to reduced calibration intervals

page 77

# Introduction SUCOFLEX®

## What are SUCOFLEX assemblies?

### SUCOFLEX

are flexible microwave cable assemblies offering better transmission characteristics than semi-rigid cables.

### SUCOFLEX

comprises an entire system of optimally matched components such as:

- Microwave cables
- Connectors
- Ruggedisations
- Marking sleeves
- ...



### SUCOFLEX

is manufactured by highly qualified HUBER+SUHNER employees and tested against strict quality standards under controlled conditions. This results in microwave cable assemblies meeting all of your needs for top quality and high precision reproducibility.

### SUCOFLEX

is always supplied as a complete, tested microwave cable assembly with defined and guaranteed radio frequency and mechanical values.

### SUCOFLEX

is defined in the following way:

One standard assembly consists of the following items if no additional specifications are provided:

- Microwave cable specified
- Connectors specified
- Marking sleeve with serial number
- RF test protocol showing insertion and return losses

### SUCOFLEX

provides an optimum solution to your microwave transmission problems.

### SUCOFLEX

cables, connectors and assemblies are entirely developed, manufactured, tested and supplied by HUBER+SUHNER, your partners for flexible microwave cable assemblies.

### SUCOFLEX

is a registered trade mark for microwave cable assemblies from HUBER+SUHNER AG.

# Advantages of SUCOFLEX®

High performance

## Test+Measurement

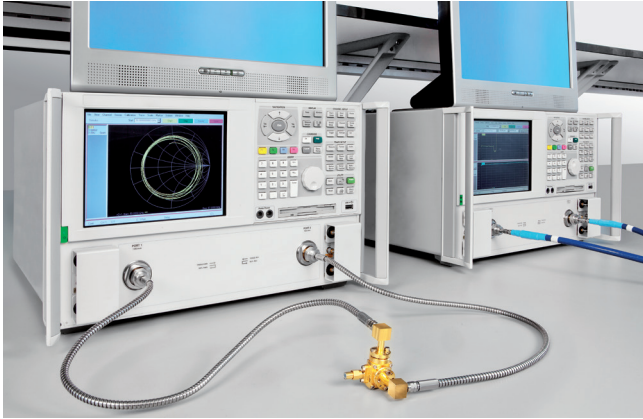

**Wide range of connectors and ruggedisation**  
PC 2.4, PC 3.5, SK, SMA, BMA, QMA, QN, BNC, TNC, N, PC7 and various ruggedisations

### Electrical stability

Thanks to their special design, types like SUCOFLEX 101, SUCOFLEX 101P, SUCOFLEX 102, SUCOFLEX 126, SUCOFLEX 526V and SUCOFLEX 526S are particularly phase stable when subjected to flexure.

## High speed digital testing

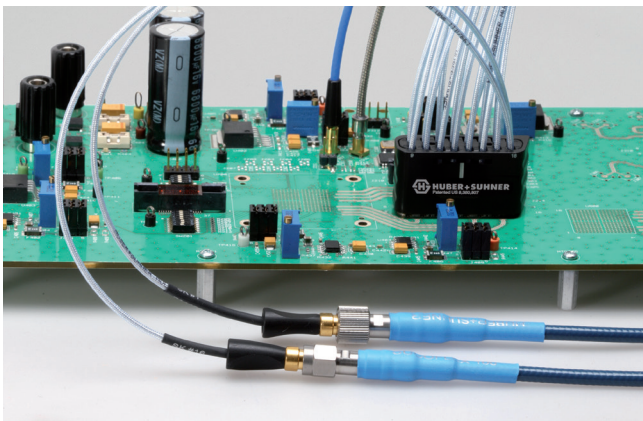

### High speed digital chip verification

Lowest loss, best signal integrity, dense and space saving PCB connectivity, proven and tested solutions and components

### High speed digital hardware and system verification

Multicoax PCB edge/panel mount solutions, customized solutions for Multicoax interconnectivity between systems and modules

### Automated test equipment

Customized Multicoax interfaces at up to 50 GHz, Snap-on interfaces up to 67 GHz, cabling solutions optimized for highest data rates and frequencies.

## Space



### Perfect assembly technology

Assembly production for space applications in in-house clean room.

### High reliability

Comprehensive series of MIL tests for verification of the outstanding specifications.

### Minimised outer diameters

Space saving wirings with the loss optimised SUCOFLEX 301 space and SUCOFLEX 340

# Advantages of SUCOFLEX®

## Defense



### Wide temperature range

-55 to +165 °C for most cable types  
-55 to +125 °C for most connector types

### Mechanical protection

A wide range of ruggedisations are available for most SUCOFLEX cable types.

### Rugged connectors

Insulators and inner conductors fully captivated, patented connector assembly techniques.

### High packing density

Easy connection and disconnection of up to 8 assemblies with multipoint connectors according to MIL-C-38999.

## Naval



### Chemical stability

Thanks to excellent materials (FEP) and inert surfaces.

### High power performance

SUCOFLEX 106 and 406 with more than 400 W at 18 GHz CW power capability.

### Halogen free

LSFH jackets for SUCOFLEX assemblies are available.

## Airborne



### Vibration stability

SUCOFLEX assemblies withstand vibrations involving accelerations up to 100 g without deterioration of their performance.

### Low weight

Unit construction system use of aluminium core conductors for an optimised assembly design with SUCOFLEX 300.

### Wide frequency range

SUCOFLEX from DC up to 50 GHz

### Minimised losses and excellent stability vs. temperature

0.6 dB/m at 18 GHz for SUCOFLEX 406  
1.0 dB/m at 18 GHz for SUCOFLEX 229 and SUCOFLEX 404  
< 500 to 800 ppm (-40 to +85 °C)



# Overview SUCOFLEX®

## Cross reference within product range

Outer diameter mm	Cable attenuation at 18 GHz dB/m	Interfaces Cables	Interfaces												
			BNC	QMA	QN	7/16	BMA	TNC	N	PC7	SMA	PC3.5	SK	PC2.4	
3.50	2.0	SUCOFLEX 301										18			
3.65	2.0	SUCOFLEX 101										26.5		40	50
3.65	3.0	SUCOFLEX 101P										26.5		40	50
3.70	1.9	SUCOFLEX 302							18			26.5		40	40
4.00	1.7	SUCOFLEX 102					18	18	18			26.5		40	46
4.14	1.6	SUCOFLEX 240										26.5		40	
4.14	1.6	SUCOFLEX 340										26.5		40	
4.60	1.3	SUCOFLEX 103	4				18	18	18			18	26.5		
5.08	1.0	SUCOFLEX 229						18	18			26.5		29	
5.08	1.0	SUCOFLEX 329						18	18			26.5		29	
5.40	1.2	SUCOFLEX 304						18				18			
5.50	1.1	SUCOFLEX 104		6	6	7.5	18	18	18	18	18	18	26.5		
5.50	1.1	SUCOFLEX 126	4			7.5	18	18	18	18	18	18	26.5		
5.50	1.0	SUCOFLEX 404						18	18			18	26.5		
7.70	1.1	SUCOFLEX 526S							18			18	26.5		
7.90	0.8	SUCOFLEX 106			6	7.5		18	18	18	18				
7.90	0.8	SUCOFLEX 118						18	18			18			
9.00	0.34 (5.5)	SUCOFLEX 307						5.5							
13.0	2.7	SUCOFLEX 526V											26.5		

 Frequency

High performance

# Summary of SUCOFLEX<sup>®</sup> qualifications

The entire SUCOFLEX family is certified to the following standards through testing, analysis or similarity.

## Temperature, altitude and humidity

- MIL-STD-810, method 518.1, procedure I

## Thermal shock

- MIL-STD-202, method 106, condition B1, 25 cycles, temperature: -54 to 125 °C

## Mechanical shock

- MIL-STD-810, method 516.3, procedure I (half-sine), 20 g, 6 to 9 ms, 45 Hz cross over frequency
- MIL-STD-810, method 516, procedure I (saw-tooth), 40 g saw-tooth pulse of 11 ms duration 3 shocks in each of the six directions

## Vibration

- MIL-STD-810, method 519.3, procedure I, figure 514.3-1, (gunfire), 26.5 min. with specified vibration profile
- MIL-STD-810, method 514.3, procedure I (random), functional: 0.2 g<sup>2</sup>/Hz, endurance: 0.83 g<sup>2</sup>/Hz
- MIL-STD-202; method 204, condition G (sinusoidal), acceleration: 30 g, frequency range: 10 to 2000 Hz, duration: 4 hours in each of three axes

## Acceleration

- MIL-STD-810, method 513.3, procedure II, 27 g, 5 min.
- MIL-STD-810, method 513.3, procedure I, 50 g, 5 min.

## Chemical resistance

- British standard 3G100, part 2, section 3, class A

## Moisture resistance

- MIL-STD-202, method 106, 10 day exposure

## Salt fog

- MIL-STD-810, method 509.2, 48 hours exposure to a 5 % solution

## Fungus

- MIL-STD-810, method 508.3

## Sand and dust

- Def. stand. 07-55, part 2, section 4, issue 1, +35 °C, 3 hours

## Solar radiation

- MIL-STD-810, method 505, procedure II

# Overview SUCOFLEX® 100

The high performance microwave cable assembly

## Product description

SUCOFLEX 100 series flexible microwave cable assemblies offer superior electrical and mechanical performance for static and dynamic applications.

This series is a high-end product designed to provide optimal performance up to 50 GHz, where stringent electrical requirements – in particular stability and low loss – are important.

Their mechanical and climate resistance properties surpass those of standard flexible cables. This cable type is ideally suited to test and measurement applications (as test leads) and used in aerospace and defence systems.



## Product features

- The cable maintains stable electrical characteristics when exposed to bending and temperature, enabling reliable test results
- A balanced range of connectors is available, including types which feature NWA-specific interfaces
- Can be provided with various ruggedisations to protect the assembly against different environmental influences
- Available as assembly only

## Recommended connectors

SF101 / SF101P	SMA, SK, PC2.4
SF102	SMA, BMA, N, TNC, PC3.5, SK, PC2.4
SF103	BNC, SMA, BMA, N, TNC, PC7, PC3.5
SF126 SF104	BNC, 7/16, SMA, BMA, QMA, TNC, N, QN, PC7, PC3.5
SF106 SF118	7/16, SMA, N, QN, TNC
	Other connectors available on request

## Technical data

HUBER+SUHNER cable type	Operating frequency	Temperature range		Outer diameter mm	Nominal atten. 18 GHz, 25 °C dB/m	Bending radii		Weight g/m	More information see page
	GHz	minimum °C	maximum °C			static mm	dyn. mm		
SUCOFLEX_101	50	-55	+125	3.7	2.0	11	20	36	16
SUCOFLEX_101_P	50	-55	+125	3.7	3.0	11	20	33	16
SUCOFLEX_101_PE	50	-40	+85	3.7	3.0	11	20	30	16
SUCOFLEX_102	46	-55	+125	4.0	1.7	12	20	40	20
SUCOFLEX_102_I	46	-40	+85	4.0	1.7	12	20	36	on request
SUCOFLEX_103	33	-55	+125	4.6	1.3	13	22	53	24
SUCOFLEX_103_I	33	-40	+85	4.8	1.3	13	20	53	on request
SUCOFLEX_104	26.5	-55	+125	5.5	1.1	16	25	84	28
SUCOFLEX_104_I	26.5	-40	+85	6.6	1.1	16	25	82	on request
SUCOFLEX_126	26.5	-55	+125	5.5	1.1	16	25	84	34
SUCOFLEX_126_E	26.5	-40	+85	5.5	1.1	16	25	83	34
SUCOFLEX_106	18	-55	+125	7.9	0.8	24	40	145	38
SUCOFLEX_118	18	-55	+125	7.9	0.8	24	40	145	38
SUCOFLEX_106_I	18	-40	+85	8.2	0.8	24	40	146	38
SUCOFLEX_118_I	18	-40	+85	8.2	0.8	24	40	146	38

# SUCOFLEX® 101

The high performance microwave cable assembly working up to 50 GHz

## Product description

The SUCOFLEX 101 high end cable assemblies are designed to provide optimal performance up to 50 GHz where stringent electrical requirements – in particular stability and low loss, are important. Their mechanical and climate resistance properties surpass those of standard flexible cable. Additionally protected by an A ruggedisation, the SUCOFLEX 101PE becomes a flexible test and measurement cable up to 50 GHz!

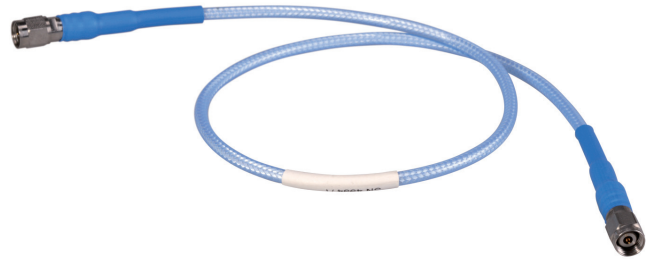

## Product features

- Impedance 50 Ω
- Applicable up to 50 GHz
- High stability and low loss
- Wide range of connectors
- VNA-specific connectors

## Recommended connectors

SF101 SF101P	SMA, SK, PC2.4
	Other connectors available on request

## Construction

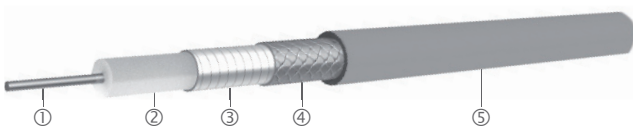

SF 101/101E/101P/101PE

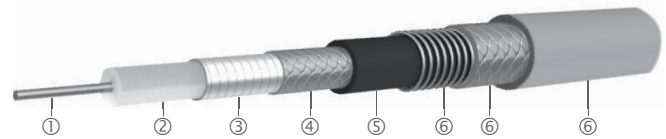

SF 101EA/PEA

Cable	Inner conductor ①	Dielectric ②	Outer conductor ③ ④	Jacket ⑤	Ruggedisation ⑥	Outer diameter mm
SUCOFLEX_101	CuAg wire	LD-PTFE	CuAg tape/braid	FEP, blue	no	3.7
SUCOFLEX_101_E	CuAg wire	LD-PTFE	CuAg tape/braid	PUR, blue	no	3.7
SUCOFLEX_101_P	CuAg strand	LD-PTFE	CuAg tape/braid	FEP, blue	no	3.7
SUCOFLEX_101_PE	CuAg strand	LD-PTFE	CuAg tape/braid	PUR, blue	no	3.7
SUCOFLEX_101_EA	CuAg wire	LD-PTFE	CuAg tape/braid	PUR	stainless steel/ PUR, blue	7.7
SUCOFLEX_101_PEA	CuAg strand	LD-PTFE	CuAg tape/braid	PUR	stainless steel/ PUR, blue	7.7



# SUCOFLEX® 101

## Assembly types

		SUCOFLEX 101	SUCOFLEX 101E	SUCOFLEX 101P	SUCOFLEX 101PE	SUCOFLEX 101EA	SUCOFLEX 101PEA
Construction							
Max. operating frequency	GHz	50	50	50	50	50	50
Application		static	static	dynamic	dynamic	static	dynamic
Velocity of propagation	%	77	77	77	77	77	77
Weight	g/m	36	33	33	30	114	111
Min. bending radius static	mm	11	11	11	11	20	20
Min. bending radius repeated	mm	20	20	20	20	40	40
Temperature range	°C	-55 to +125	-40 to +85	-55 to +125	-40 to +85	-40 to +85	-40 to +85
Crush resistance	kN/m	8	8	8	8	80	80
Tensile load	N	100	100	100	100	400	400
Inner conductor		solid wire	solid wire	strand	strand	solid wire	strand
Dielectric		LD-PTFE	LD-PTFE	LD-PTFE	LD-PTFE	LD-PTFE	LD-PTFE
Outer conductor		tape/braid	tape/braid	tape/braid	tape/braid	tape/braid	tape/braid
Jacket		FEP	PUR	FEP	PUR	PUR	PUR
Ruggedisation		no	no	no	no	stainless steel/ PUR	stainless steel/ PUR
Outer diameter	mm	3.7	3.7	3.7	3.7	7.7	7.7
Screening effectiveness (up to 18 GHz)	dB	> 90	> 90	> 90	> 90	> 90	> 90
Phase stability vs. flexure (360°, diameter 40 mm)	°el/GHz	< 1.2	< 1.2	< 0.9	< 0.9	< 1.2	< 0.9
Phase stability vs. temperature (-40 to +85 °C)	ppm	< 1500	< 1500	< 1500	< 1500	< 1500	< 1500
Assembly phase matching tolerances	°el/GHz	± 0.5	± 0.5	± 0.5	± 0.5	± 0.5	± 0.5
Cable attenuation at 25 °C	dB/m	see graph	see graph	see graph	see graph	see graph	see graph
Insertion loss stability vs. bending	dB	± 0.2	± 0.2	± 0.2	± 0.2	± 0.2	± 0.2
Insertion loss stability vs. temperature	%/°C	< 0.2	< 0.2	< 0.2	< 0.2	< 0.2	< 0.2
Insertion loss stability vs. shaking	dB	± 0.1	± 0.1	± 0.1	± 0.1	± 0.1	± 0.1
Power handling	watt	see graph	see graph	see graph	see graph	see graph	see graph

# SUCOFLEX® 101

Attenuation (nominal values at +25 °C ambient temperature)



Power handling (maximum values at 25 °C ambient temperature and sea level)

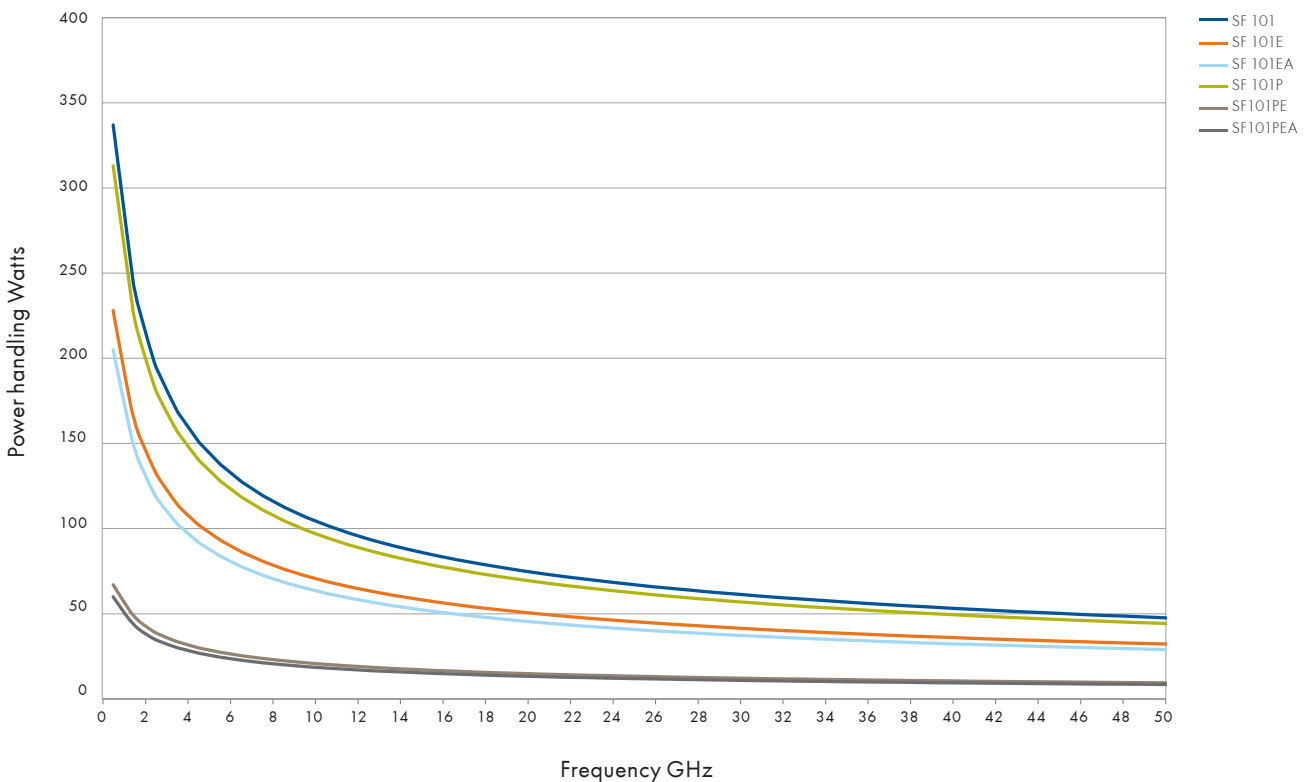

# SUCOFLEX® 101

## Available connectors

Connector	Series, pattern	HUBER+SUHNER connector type	SF101 SF101E	SF101EA	SF101P SF101PE	SF101PEA	Op. freq. GHz	VSWR per connector	Remarks
DV	straight cable plug	11_DV-112				•	50	1.20	2.4 mm connector for Agilent Technologies Instrument
SK	straight cable plug	11_SK-100			•		40	1.20	
	straight cable plug	11_SK-110				•	40	1.20	
	straight cable jack	21_SK-110				•	40	1.20	
PC 2.4	straight cable plug	11_PC2.4-104	•				50	1.20	
	straight cable plug	11_PC2.4-107			•		50	1.20	
	straight cable plug	11_PC2.4-109		•			50	1.20	
	straight cable plug	11_PC2.4-110				•	50	1.20	
	straight cable jack	21_PC2.4-104	•				50	1.20	
	straight cable jack	21_PC2.4-107			•		50	1.20	
	straight cable jack	21_PC2.4-109		•			50	1.20	
	straight cable jack	21_PC2.4-110				•	50	1.20	
	straight panel bulkhead cable jack	24_PC2.4-102	•				50	1.20	ML 38
	SMA	straight cable plug	11_SMA-153			•		18 26.5	1.12 1.20
straight cable plug		11_SMA-190	•				18 26.5		

## Stock assemblies

Item no.	Type	Length mm	Frequency GHz	Max. insertion loss at 25 °C dB	Max. VSWR	RoHS compliant
<b>SUCOFLEX_101</b>						
85026753	SF101/PC24m/PC24m/500 mm	500	50	2.29	1.44	yes
<b>SUCOFLEX_101_EA (armoured)</b>						
85026754	SF101EA/PC24m/PC24m/500 mm	500	50	2.29	1.44	yes

# SUCOFLEX® 102

The high performance microwave cable assembly working up to 46 GHz

## Product description

SUCOFLEX 102 are ideal for applications up to 46 GHz or wherever the weight or the diameter are the critical factors to be taken into account. The connectors mainly used here are PC2.4 and SK, for «low frequency» applications also SMA, N and TNC. Typical applications include test laboratories and aircraft manufacture. The available ruggedisations are matched to the particular applications.



## Product features

- Impedance 50 Ω
- Applicable up to 46 GHz
- High stability and low loss
- Wide range of connectors
- LSFH jacket and further ruggedisations on request

## Recommended connectors

SF102	SMA, N, TNC, PC3.5, SK, PC2.4
	Other connectors available on request

## Construction

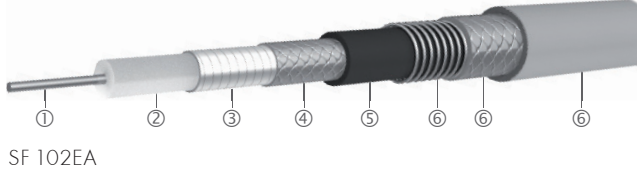
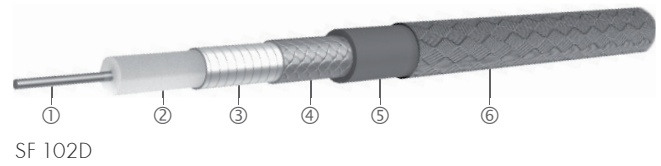
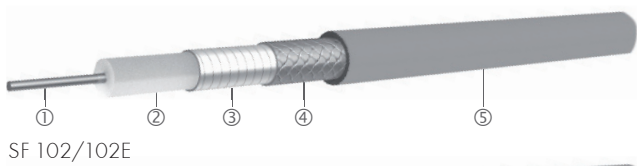



Cable	Inner conductor ①	Dielectric ②	Outer conductor ③ ④	Jacket ⑤	Ruggedisation ⑥	Outer diameter mm
SUCOFLEX_102	CuAg wire	LD-PTFE	CuAg tape/braid	FEP, blue	no	4.0
SUCOFLEX_102_E	CuAg wire	LD-PTFE	CuAg tape/braid	PUR, blue	no	4.0
SUCOFLEX_102_D	CuAg wire	LD-PTFE	CuAg tape/braid	FEP	aramid yarn braid, blue	4.6
SUCOFLEX_102_EA	CuAg wire	LD-PTFE	CuAg tape/braid	PUR	stainless steel/ PUR, blue	7.7



# SUCOFLEX® 102

## Assembly types

		SUCOFLEX 102	SUCOFLEX 102E	SUCOFLEX 102D	SUCOFLEX 102EA
Construction					
Max. operating frequency	GHz	46	46	46	46
Application		static	static	static	static
Velocity of propagation	%	77	77	77	77
Weight	g/m	40	37	45	120
Min. bending radius static	mm	12	12	15	20
Min. bending radius repeated	mm	20	20	30	40
Temperature range	°C	-55 to +125	-40 to +85	-55 to +125	-40 to +85
Crush resistance	kN/m	8	8	8	80
Tensile load	N	150	150	150	400
Inner conductor		solid wire	solid wire	solid wire	solid wire
Dielectric		LD-PTFE	LD-PTFE	LD-PTFE	LD-PTFE
Outer conductor		tape/braid	tape/braid	tape/braid	tape/braid
Jacket		FEP	PUR	FEP	PUR
Ruggedisation		no	no	aramid yarn braid	stainless steel/PUR
Outer diameter	mm	4.0	4.0	4.6	7.7
Screening effectiveness (up to 18 GHz)	dB	> 90	> 90	> 90	> 90
Phase stability vs. flexure (360°, diameter 55 mm)	°el/GHz	< 1.2	< 1.2	< 1.2	< 1.2
Phase stability vs. temperature (-40 to +85 °C)	ppm	< 1500	< 1500	< 1500	< 1500
Assembly phase matching tolerances	°el/GHz	± 0.5	± 0.5	± 0.5	± 0.5
Cable attenuation at 25 °C	dB/m	see graph	see graph	see graph	see graph
Insertion loss stability vs. bending	dB	± 0.2	± 0.2	± 0.2	± 0.2
Insertion loss stability vs. temperature	%/°C	< 0.2	< 0.2	< 0.2	< 0.2
Insertion loss stability vs. shaking	dB	± 0.1	± 0.1	± 0.1	± 0.1
Power handling	watt	see graph	see graph	see graph	see graph

# SUCOFLEX<sup>®</sup> 102

Attenuation (nominal values at +25 °C ambient temperature)

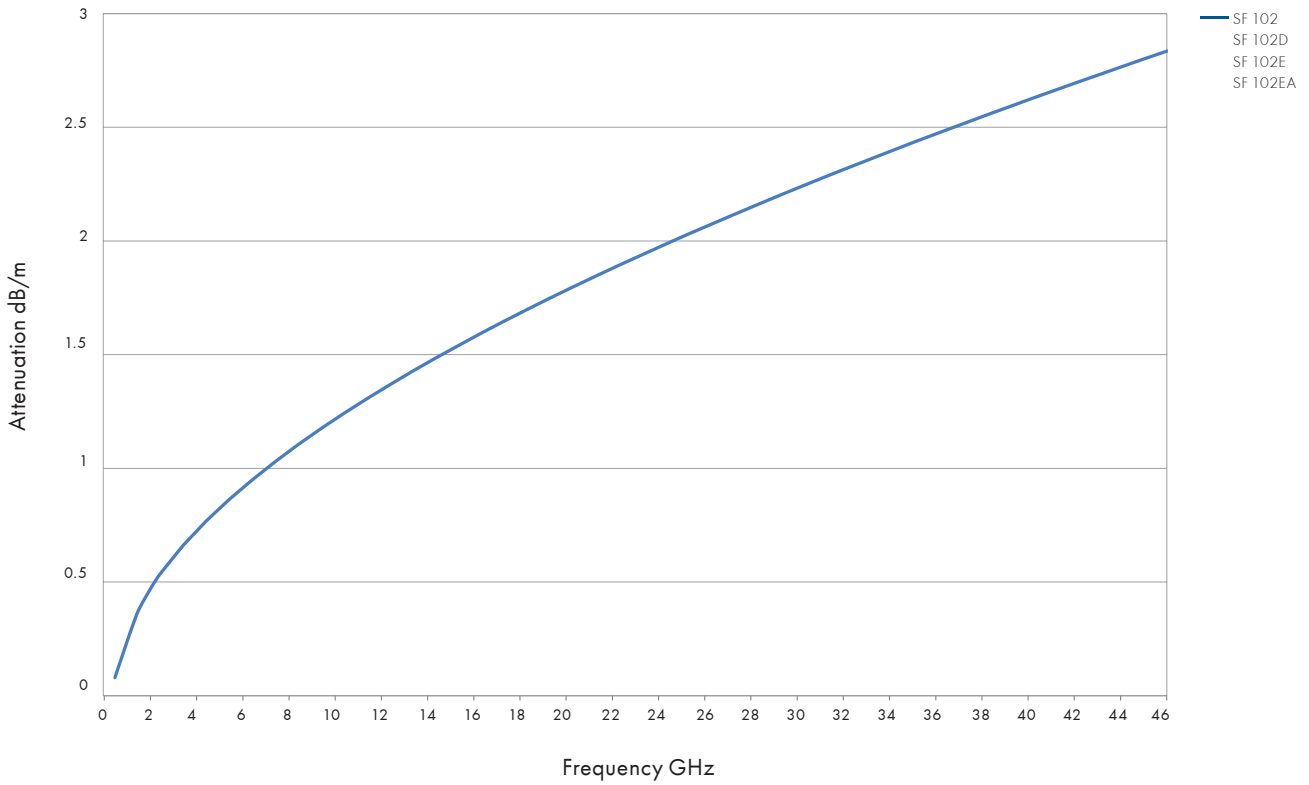

Power handling (maximum values at 25 °C ambient temperature and sea level)

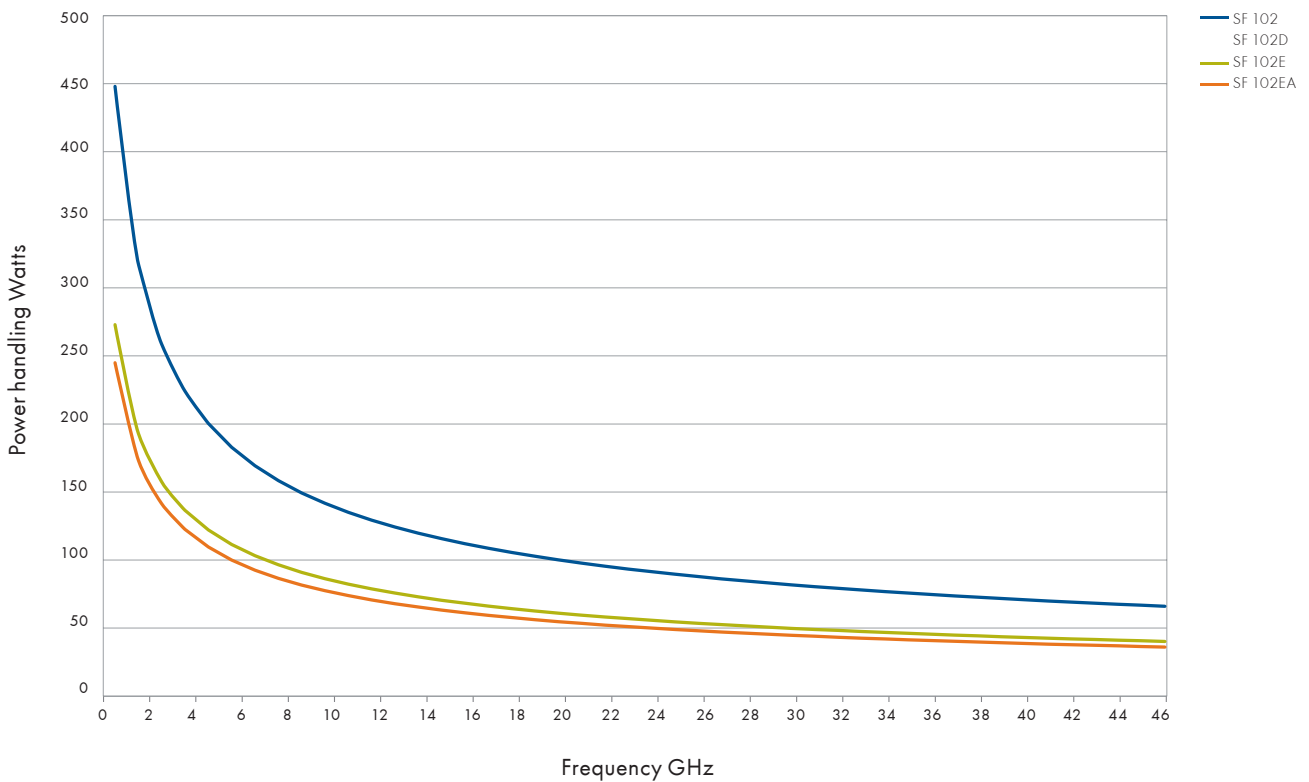

# SUCOFLEX® 102

## Available connectors

Connector	Series, pattern	HUBER+SUHNER connector type	SF102 SF102E	SF102EA	SF102D	Operating frequency GHz	VSWR per connector	Remarks
SK	straight cable plug	11_SK-252	•		•	40	1.20	
	straight cable plug	11_SK-253	•			40	1.20	QL nut
	straight cable plug	11_SK-258		•		40	1.20	
	straight cable plug	11_SK-262		•		40	1.20	QL nut
	right angle cable plug	16_SK-252	•		•	40	1.20	
	right angle cable plug	16_SK-255		•		40	1.20	
	straight cable jack	21_SK-252	•		•	40	1.20	
	straight cable jack	21_SK-257		•		40	1.20	
	straight panel bulkhead cable jack	24_SK-251	•		•	40	1.20	ML 35
N	straight cable plug	11_N-206	•		•	18	1.12	
PC 2.4	straight cable plug	11_PC2.4-201	•		•	46	1.20	
	straight cable plug	11_PC2.4-210		•		46	1.20	
	straight cable jack	21_PC2.4-201	•		•	46	1.20	
	straight cable jack	21_PC2.4-210		•		46	1.20	
	straight panel bulkhead cable jack	24_PC2.4-201	•		•	46	1.20	ML 38
PC 3.5	straight cable plug	11_PC3.5-203	•		•	26.5	1.16	
	straight cable jack	21_PC3.5-203	•		•	26.5	1.16	
SMA	straight cable plug	11_SMA-218	•		•	18 26.5	1.12 1.20	
	straight cable plug	11_SMA-262		•		18 26.5	1.12 1.20	
	right angle cable plug	16_SMA-254	•		•	18	1.12	
	straight cable jack	21_SMA-204	•		•	18 26.5	1.12 1.20	
	straight panel bulkhead cable jack	24_SMA-210	•		•	18 26.5	1.12 1.20	ML 20
TNC	straight cable plug	11_TNC-222	•		•	18	1.12	
	straight panel bulkhead cable jack	24_TNC-222	•		•	18	1.12	ML 4

High performance

## Stock assemblies

Item no.	Type	Length mm	Frequency GHz	Max. insertion loss at 25 °C dB	Max. VSWR	RoHS compliant
<b>SUCOFLEX_102</b>						
84017146	SF102/SKm/SKm/500 mm	500	40	1.76	1.44	yes
84017149	SF102/SKm/SKm/1000 mm	1000	40	3.21	1.44	yes
<b>SUCOFLEX_102_EA (armoured)</b>						
85026755	SF102EA/SKm/SKm/500 mm	500	40	1.76	1.44	yes
85026756	SF102EA/SKm/SKm/1000 mm	1000	40	3.21	1.44	yes

# SUCOFLEX® 103

The high performance microwave cable assembly working up to 33 GHz

## Product description

SUCOFLEX 103 is the ideal solution for systems in which the attenuation to weight ratio is very important. Different ruggedisations and a large number of the common connector types complete this range.

## Product features

- Impedance 50 Ω
- Applicable up to 33 GHz
- High stability and low loss
- Wide range of connectors
- LSFH jacket and further ruggedisations on request

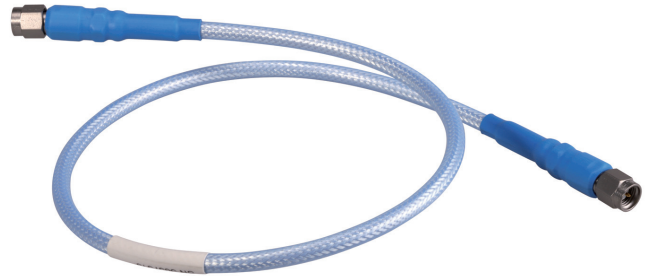

## Recommended connectors

SF103	SMA, BMA, QMA, BNC, N, TNC, PC7, PC3.5
	Other connectors available on request

## Construction

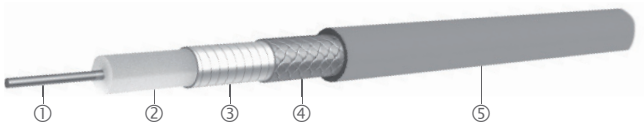

SF 103/103E

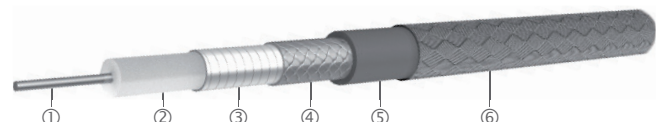

SF 103D

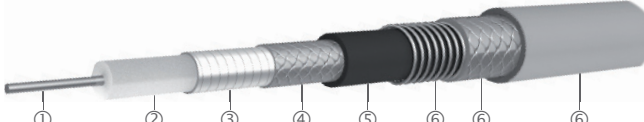



SF 103EA

Cable	Inner conductor ①	Dielectric ②	Outer conductor ③ ④	Jacket ⑤	Ruggedisation ⑥	Outer diameter mm
SUCOFLEX_103	CuAg wire	LD-PTFE	CuAg tape/braid	FEP, blue	no	4.6
SUCOFLEX_103_E	CuAg wire	LD-PTFE	CuAg tape/braid	PUR, blue	no	4.6
SUCOFLEX_103_D	CuAg wire	LD-PTFE	CuAg tape/braid	FEP	aramid yarn braid, blue	5.1
SUCOFLEX_103_EA	CuAg wire	LD-PTFE	CuAg tape/braid	PUR	stainless steel/ PUR, blue	10.3

# SUCOFLEX® 103

## Assembly types

		SUCOFLEX 103	SUCOFLEX 103E	SUCOFLEX 103D	SUCOFLEX 103EA
Construction					
Max. operating frequency	GHz	33	33	33	33
Application		static	static	static	static
Velocity of propagation	%	77	77	77	77
Weight	g/m	53	52	63	142
Min. bending radius static	mm	13	13	20	30
Min. bending radius repeated	mm	22	22	30	50
Temperature range	°C	-55 to +125	-40 to +85	-55 to +125	-40 to +85
Crush resistance	kN/m	8	8	8	80
Tensile load	N	200	200	200	400
Inner conductor		solid wire	solid wire	solid wire	solid wire
Dielectric		LD-PTFE	LD-PTFE	LD-PTFE	LD-PTFE
Outer conductor		tape/braid	tape/braid	tape/braid	tape/braid
Jacket		FEP	PUR	FEP	PUR
Ruggedisation		no	no	aramid yarn braid	stainless steel/PUR
Outer diameter	mm	4.6	4.6	5.1	10.3
Screening effectiveness (up to 18 GHz)	dB	> 90	> 90	> 90	> 90
Phase stability vs. flexure (360°, diameter 55 mm)	°el/GHz	< 1.4	< 1.4	< 1.4	< 1.4
Phase stability vs. temperature (-40 to +85 °C)	ppm	< 1500	< 1500	< 1500	< 1500
Assembly phase matching tolerances	°el/GHz	± 0.5	± 0.5	± 0.5	± 0.5
Cable attenuation at 25 °C	dB/m	see graph	see graph	see graph	see graph
Insertion loss stability vs. bending	dB	± 0.2	± 0.2	± 0.2	± 0.2
Insertion loss stability vs. temperature	%/°C	< 0.2	< 0.2	< 0.2	< 0.2
Insertion loss stability vs. shaking	dB	± 0.1	± 0.1	± 0.1	± 0.1
Power handling	watt	see graph	see graph	see graph	see graph



# SUCOFLEX<sup>®</sup> 103

Attenuation (nominal values at +25 °C ambient temperature)

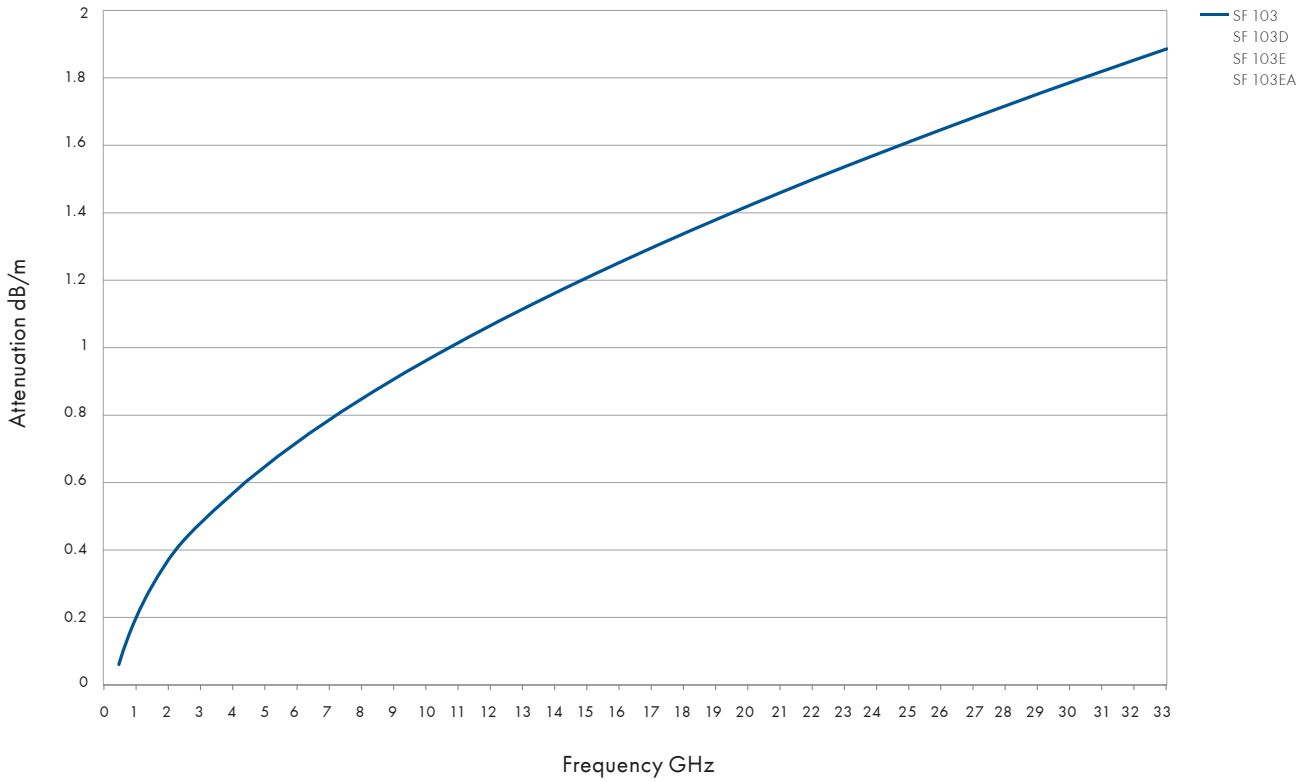

Power handling (maximum values at 25 °C ambient temperature and sea level)

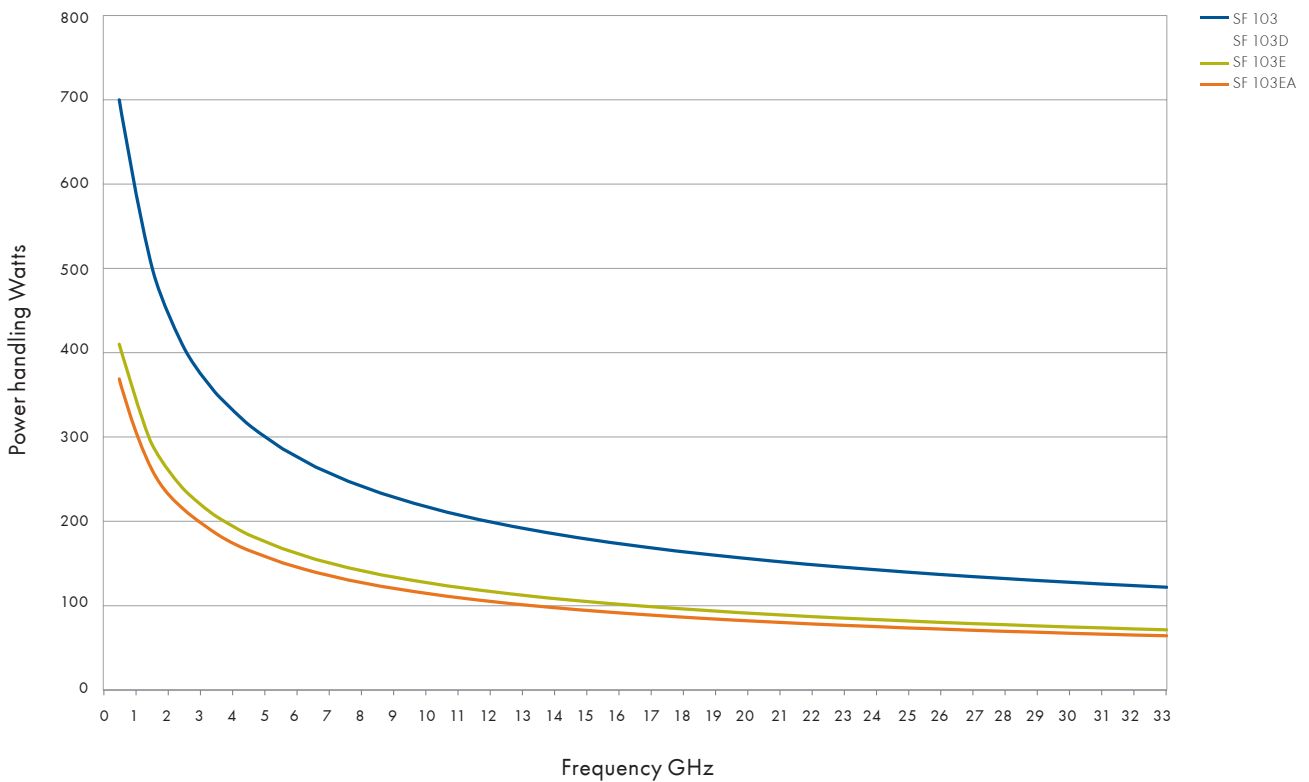

# SUCOFLEX® 103

## Available connectors

Connector		HUBER+SUHNER connector type	SF103 SF103E	SF103EA	SF103D	Operating frequency GHz	VSWR per connector	Remarks
BNC	straight cable plug	11_BNC-373	•		•	4	1.14	
N	straight cable plug	11_N-371	•	•	•	18	1.12	
	right angle cable plug	16_N-372	•	•	•	18	1.12	swept
	straight panel bulkhead cable jack	24_N-352	•	•	•	18	1.12	ML 12
PC 3.5	straight cable plug	11_PC3.5-31	•	•	•	26.5	1.16	
	straight cable jack	21_PC3.5-31	•	•	•	26.5	1.16	
PC 7	straight cable plug	11_PC7-31	•		•	18	1.10	
SMA	straight cable plug	11_SMA-367	•	•		18	1.12	QL nut
	straight cable plug	11_SMA-371	•	•	•	18	1.12	
	right angle cable plug	16_SMA-371	•	•	•	18	1.12	
	straight cable jack	21_SMA-371	•	•	•	18	1.12	
	straight panel bulkhead cable jack	24_SMA-371	•	•	•	18	1.12	ML 35
TNC	straight cable plug	11_TNC-353	•	•	•	18	1.12	
	straight panel bulkhead cable jack	24_TNC-353	•	•	•	18	1.12	ML 4

# SUCOFLEX® 104

The high performance microwave cable assembly working up to 26.5 GHz

## Product description

SUCOFLEX 104 cables that can be universally assembled with the widest range of connector types, are available with most ruggedisations.

## Product features

- Impedance 50 Ω
- Applicable up to 26.5 GHz
- High stability and low loss
- Wide range of connectors
- VNA-specific connectors
- Quick lock nuts
- LSFH jacket and further ruggedisations on request



## Recommended connectors

SF104	SMA, BMA, QMA, BNC, TNC, N, QN, 7/16, PC3.5
	Other connectors available on request

## Construction

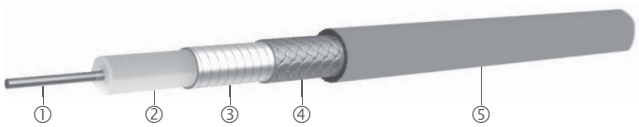

SF 104/104E

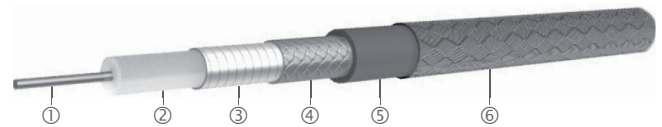



SF 104D

Cable	Inner conductor ①	Dielectric ②	Outer conductor ③ ④	Jacket ⑤	Ruggedisation ⑥	Outer diameter mm
SUCOFLEX_104	CuAg wire	LD-PTFE	CuAg tape/braid	FEP, blue	no	5.5
SUCOFLEX_104_E	CuAg wire	LD-PTFE	CuAg tape/braid	PUR, blue	no	5.5
SUCOFLEX_104_D	CuAg wire	LD-PTFE	CuAg tape/braid	FEP	aramid yarn braid, blue	6.1

# SUCOFLEX® 104

## Assembly types

		SUCOFLEX 104	SUCOFLEX 104E	SUCOFLEX 104D
Construction				
Max. operating frequency	GHz	26.5	26.5	26.5
Application		static	static	static
Velocity of propagation	%	77	77	77
Weight	g/m	73	65	96
Min. bending radius static	mm	16	16	20
Min. bending radius repeated	mm	25	25	30
Temperature range	°C	-55 to +125	-40 to +85	-55 to +125
Crush resistance	kN/m	8	8	8
Tensile load	N	250	250	250
Inner conductor		solid wire	solid wire	solid wire
Dielectric		LD-PTFE	LD-PTFE	LD-PTFE
Outer conductor		tape/braid	tape/braid	tape/braid
Jacket		FEP	PUR	FEP
Ruggedisation		no	no	aramid yarn braid
Outer diameter	mm	5.5	5.5	6.1
Screening effectiveness (up to 18 GHz)	dB	> 90	> 90	> 90
Phase stability vs. flexure (360°, diameter 55 mm)	°el/GHz	< 1.7	< 1.7	< 1.7
Phase stability vs. temperature (-40 to +85 °C)	ppm	< 1500	< 1500	< 1500
Assembly phase matching tolerances	°el/GHz	± 0.5	± 0.5	± 0.5
Cable attenuation at 25 °C	dB/m	see graph	see graph	see graph
Insertion loss stability vs. bending	dB	± 0.2	± 0.2	± 0.2
Insertion loss stability vs. temperature	%/°C	< 0.2	< 0.2	< 0.2
Insertion loss stability vs. shaking	dB	± 0.1	± 0.1	± 0.1
Power handling	watt	see graph	see graph	see graph

# SUCOFLEX<sup>®</sup> 104

Attenuation (nominal values at +25 °C ambient temperature)

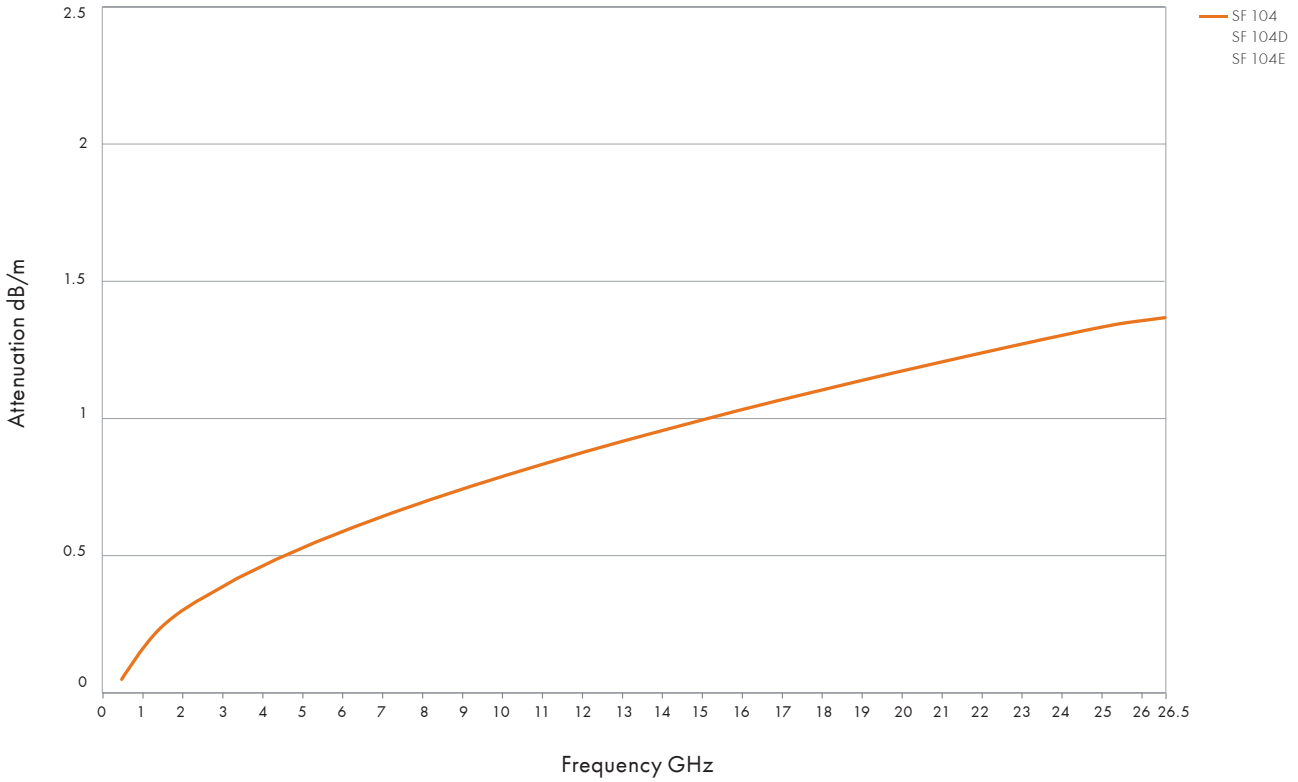

Power handling (maximum values at 25 °C ambient temperature and sea level)

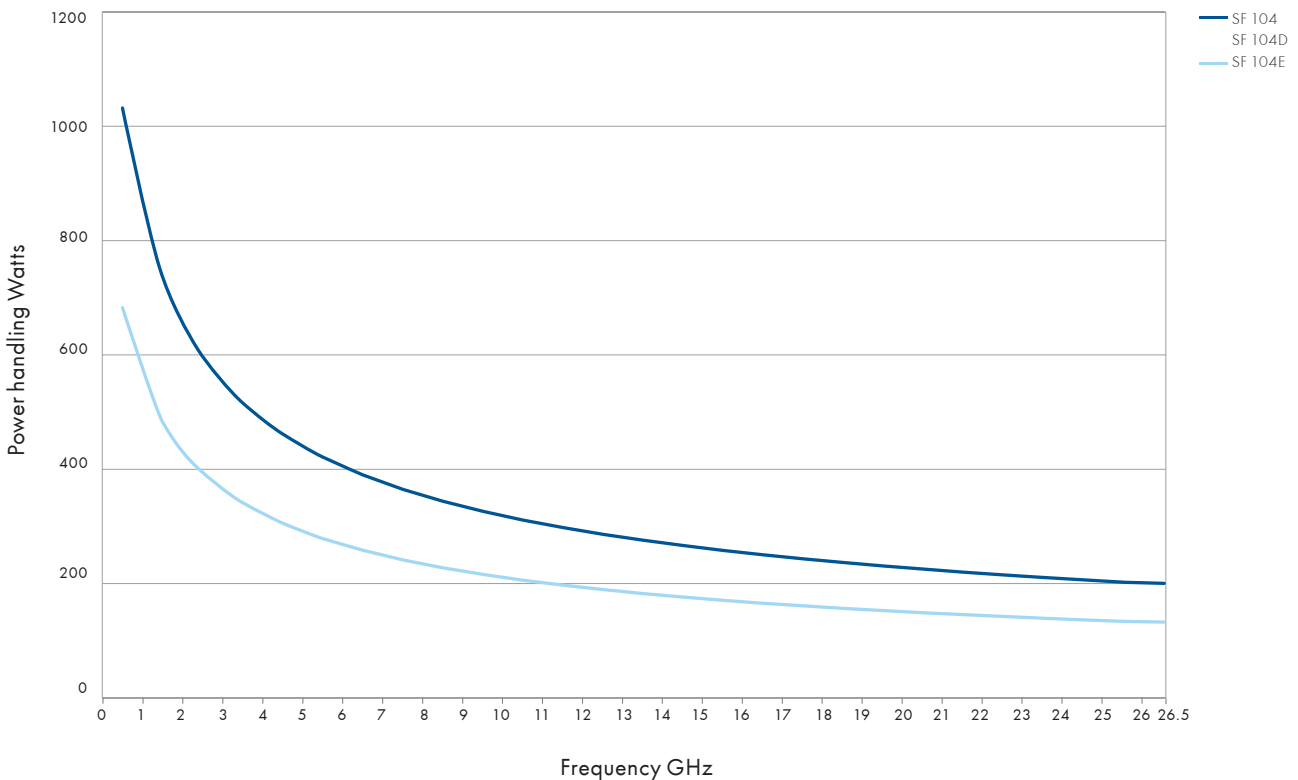

# SUCOFLEX® 104

## Available connectors

Connector	Series, pattern	HUBER+SUHNER connector type	SF104 SF104E	SF104D	Operating frequency GHz	VSWR per connector	Remarks
BNC	straight cable plug	11_BNC-451	•	•	4	1.14	
N	straight cable plug	11_N-47	•	•	15 18	1.12 1.16	
	straight cable plug	11_N-451	•	•	18	1.12	
	straight cable plug	11_N-454	•	•	15 18	1.12 1.16	hexagonal nut with safety holes
	straight cable plug	11_N-456	•	•	18	1.12	hexagonal nut with safety holes
	right angle cable plug	16_N-44	•	•	12.4 18	1.14 1.18	
	straight cable jack	21_N-47	•	•	11 15	1.12 1.16	
	straight cable jack	21_N-451	•	•	18	1.12	
	straight panel bulkhead cable jack	24_N-47	•	•	11 15	1.12 1.16	ML 12
	straight panel bulkhead cable jack	24_N-451	•	•	18	1.12	ML 12
PC 3.5	straight cable plug	11_PC3.5-42	•	•	18 26.5	1.12 1.16	
	straight cable jack	21_PC3.5-42	•	•	18 26.5	1.12 1.16	
PC 7	straight cable plug	11_PC7-41	•	•	18	1.1	
QMA	straight cable plug	11_QMA-W401	•		6	1.07	
QN	straight cable plug	11_QN-403	•		6	1.07	
SMA	straight cable plug	11_SMA-451	•	•	18	1.12	
	straight cable plug	11_SMA-456	•	•	18	1.12	hexagonal nut with safety holes
	straight cable plug	11_SMA-468	•	•	18	1.12	QL nut
	right angle cable plug	16_SMA-451	•	•	18	1.12	
	straight cable jack	21_SMA-451	•	•	18	1.12	
	straight panel bulkhead cable jack	24_SMA-451	•	•	18	1.12	ML 35
TNC	straight cable plug	11_TNC-418	•	•	12.4 18	1.14 1.18	QL nut
	straight cable plug	11_TNC-457	•	•	18	1.12	
	right angle cable plug	16_TNC-454	•	•	18	1.14	
	straight panel bulkhead cable jack	24_TNC-457	•	•	18	1.12	ML 4
7/16	straight cable plug	11_716-401	•	•	7.5	1.12	
	straight cable jack	21_716-401	•	•	7.5	1.12	



# SUCOFLEX® 104

## Stock assemblies

Item no.	Type	Length	Frequency	Max. insertion loss at 25 °C	Max. VSWR	RoHS compliant
		mm	GHz	dB		
<b>SUCOFLEX_104</b>						
84017153	SF104/Nm/Nm/500 mm	500	18	0.82	1.35	yes
84016754	SF104/SMAm/SMAm/500 mm	500	18	0.82	1.25	yes
84017154	SF104/PC35m/PC35m/500 mm	500	26.5	1.01	1.35	yes
84017155	SF104/SMAm/Nm/1000 mm	1000	18	1.43	1.30	yes
84017157	SF104/Nm/Nm/1000 mm	1000	18	1.43	1.35	yes
84016755	SF104/SMAm/SMAm/1000 mm	1000	18	1.43	1.25	yes
84017158	SF104/PC35m/PC35m/1000 mm	1000	26.5	1.77	1.35	yes
84017067	SF104/Nm/Nm/1500 mm	1500	18	2.03	1.35	yes
84016756	SF104/SMAm/SMAm/1500 mm	1500	18	2.03	1.25	yes
84017159	SF104/SMAm/Nm/2000 mm	2000	18	2.64	1.30	yes
84017160	SF104/Nm/Nm/2000 mm	2000	18	2.64	1.35	yes
84016757	SF104/SMAm/SMAm/2000 mm	2000	18	2.64	1.25	yes



# SUCOFLEX® 126

The low loss, phase stable assembly up to 26.5 GHz

## Product description

SUCOFLEX\_126 cables combines the low loss and power of SUCOFLEX 104 with the phase stability of SUCOFLEX 104P. Where low loss, combined with phase and amplitude stability is required, SUCOFLEX\_126 must be applied.

## Product features

- Applicable up to 26.5 GHz
- Excellent return loss
- Excellent phase- and amplitude stability
- Low loss
- Wide range of connectors
- Crush resistant armour available
- Available from stock



## Recommended connectors

SF126	BNC, DV, N, PC3.5; PC7, SMA, TNC, 7/16
	Other connectors available on request

## Construction

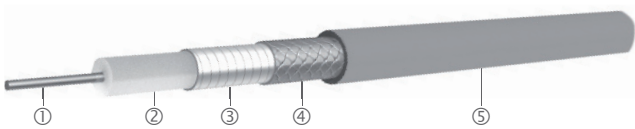

SF 126/126E

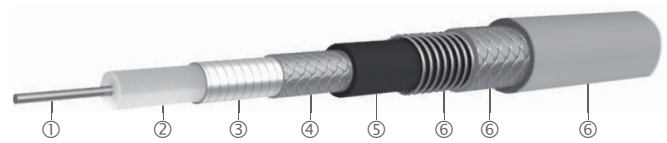



SF 126EA

Cable	Inner conductor ①	Dielectric ②	Outer conductor ③ ④	Jacket ⑤	Ruggedisation ⑥	Outer diameter
						mm
SUCOFLEX_126	CuAg stranded - low loss	LD-PTFE	CuAg tape/braid	FEP, blue	no	5.5
SUCOFLEX_126_E	CuAg stranded - low loss	LD-PTFE	CuAg tape/braid	PUR, blue	no	5.5
SUCOFLEX_126_EA	CuAg stranded - low loss	LD-PTFE	CuAg tape/braid	PUR	stainless steel/PUR, blue	10.3

# SUCOFLEX® 126

## Assembly types

		SUCOFLEX 126	SUCOFLEX 126E	SUCOFLEX 126EA
Construction				
Max. operating frequency	GHz	26.5	26.5	26.5
Application		dynamic	dynamic	dynamic
Velocity of propagation	%	77	77	77
Weight	g/m	70	66	171
Min. bending radius static	mm	16	16	30
Min. bending radius repeated	mm	25	25	50
Temperature range	°C	-55 to +125	-40 to +85	-40 to +85
Crush resistance	kN/m	8	8	80
Tensile load	N	250	250	500
Inner conductor		stranded - low loss	stranded - low loss	stranded - low loss
Dielectric		LD-PTFE	LD-PTFE	LD-PTFE
Outer conductor		tape/braid	tape/braid	tape/braid
Jacket		FEP	PUR	PUR
Ruggedisation		no	no	stainless steel/PUR
Outer diameter	mm	5.5	5.5	10.3
Screening effectiveness (up to 18 GHz)	dB	> 90	> 90	> 90
Phase stability vs. flexure (360°, diameter 55 mm)	°el/GHz	< 0.9	< 0.9	< 0.9
Phase stability vs. temperature (-40 to +85 °C)	ppm	< 1500	< 1500	< 1500
Assembly phase matching tolerances	°el/GHz	± 0.5	± 0.5	± 0.5
Cable attenuation at 25 °C	dB/m	see graph	see graph	see graph
Insertion loss stability vs. bending	dB	± 0.2	± 0.2	± 0.2
Insertion loss stability vs. temperature	%/°C	< 0.2	< 0.2	< 0.2
Insertion loss stability vs. shaking	dB	± 0.1	± 0.1	± 0.1
Power handling	watt	see graph	see graph	see graph

# SUCOFLEX® 126

Attenuation (nominal values at +25 °C ambient temperature)

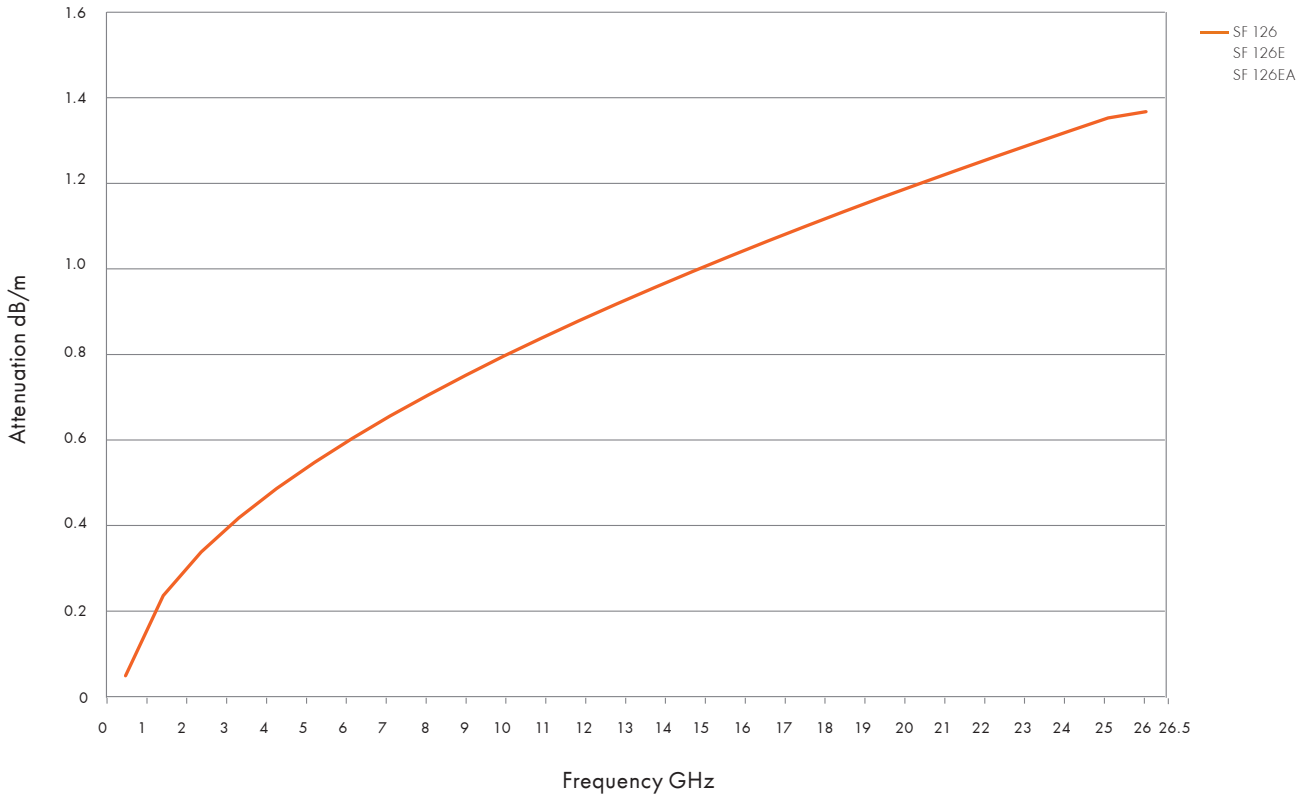

Power handling (maximum values at 25 °C ambient temperature and sea level)

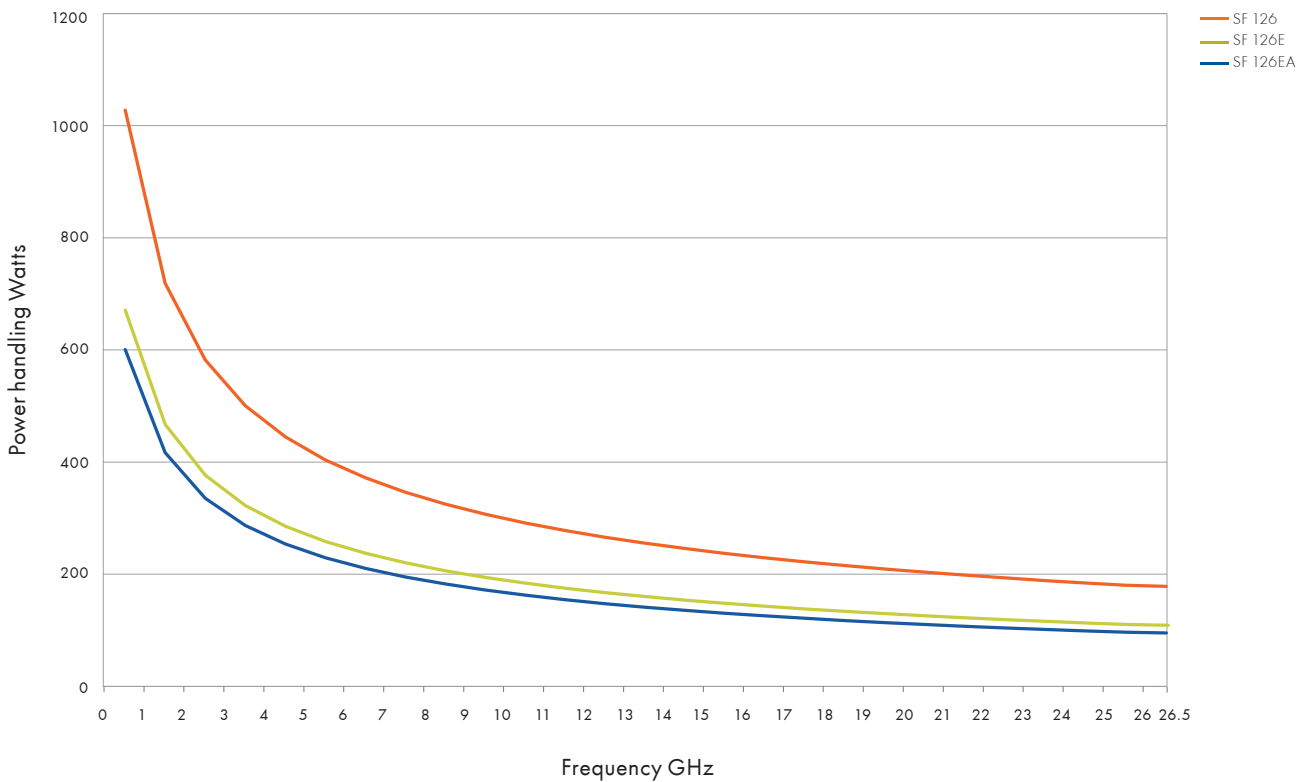

# SUCOFLEX® 126

## Available connectors

Connector	Series, pattern	HUBER+SUHNER connector type	SF126	SF126E	SF126EA	Operating frequency (GHz)	VSWR per connector	Remarks
BNC	Straight cable plug	11_BNC-452	•	•	•	4.0	1.14	
DV	Straight cable plug	11_DV-41	•	•	•	26.5	1.16	3.5mm connector for Agilent Technologies instrument
N	straight cable plug	11_N-47	•	•	•	15 18	1.12 1.16	
	Straight cable plug	11_N-452	•	•	•	18.0	1.12	
	Straight cable plug	11_N-454	•	•	•	15 18	1.12 1.16	Hexagonal nut w. safety holes
	Right angle cable plug	16_N-457	•	•	•	12.4 18.0	1.14 1.18	
	Straight cable jack	21_N-452	•	•	•	18	1.12	
	Straight panel bulkhead cable jack	24_N-452	•	•	•	18	1.12	Mounting hole size 12
PC 3.5	Straight cable plug	11_PC3.5-43	•	•	•	18 26.5	1.12 1.16	
	Straight cable jack	21_PC3.5-43	•	•	•	18 26.5	1.12 1.16	
PC 7	Straight cable plug	11_PC7-42	•	•	•	18	1.1	
SMA	Straight cable plug	11_SMA-451	•	•	•	18	1.12	
	Straight cable plug	11_SMA-452	•	•	•	18	1.16	phase matching connector
	Straight cable plug	11_SMA-456	•	•	•	18	1.12	Hexagonal nut w. safety holes
	Straight cable plug	11_SMA-468	•	•	•	18	1.12	Quick lock nut
	Right angle cable plug	16_SMA-452	•	•	•	18	1.12	
	Straight cable jack	21_SMA-451	•	•	•	18	1.12	
	Straight panel bulkhead cable jack	24_SMA-451	•	•	•	18	1.12	Mounting hole size 35
TNC	Straight cable plug	11_TNC-456	•	•	•	18	1.12	
	Straight panel bulkhead cable jack	24_TNC-456	•	•	•	18	1.12	Mounting hole size 4
7/16	Straight cable plug	11_716-402	•	•	•	7.5	1.12	
	Straight cable jack	21_716-402	•	•	•	7.5	1.12	

## Stock assemblies

Item no.	Type	Length	Frequency	Max. insertion loss at 25 °C	Max. VSWR	RoHS compliant
		mm	GHz	dB		
<b>SUCOFLEX_126_E</b>						
85072824	SF126E/SMAm/SMAm/500mm	500	18.0	0.82	1.25	yes
85072825	SF126E/SMAm/SMAm/1000mm	1000	18.0	1.43	1.25	yes
85072826	SF126E/PC35m/PC35m/1000mm	1000	26.5	1.77	1.35	yes
<b>SUCOFLEX_126_EA (armoured)</b>						
85072828	SF126EA/Nm/Nm/1000mm	1000	18.0	1.43	1.25	yes
85072827	SF126EA/SMAm/SMAm/1000mm	1000	18.0	1.43	1.25	yes
85072829	SF126EA/Nm/Nf/1500mm	1500	18.0	2.03	1.25	yes
85072830	SF126EA/Nm/Nm/1500mm	1500	18.0	2.03	1.25	yes



# SUCOFLEX® 106 / 118

The high performance microwave cable assembly working up to 18 GHz

## Product description

SUCOFLEX 106 and 118 are used in applications where special consideration must be given to low attenuation or high power handling capacity. Wherever phase stability is additionally demanded, the suitable type is the SUCOFLEX 118. Most ruggedisations can be used in conjunction with these cables, and also the main connector series.



## Product features

- Impedance 50 Ω
- Applicable up to 18 GHz
- High stability and low loss
- Wide range of connectors
- Further ruggedisations on request

## Recommended connectors

SF106 SF118	SMA, TNC, N, QN, 7/16
	Other connectors available on request

## Construction

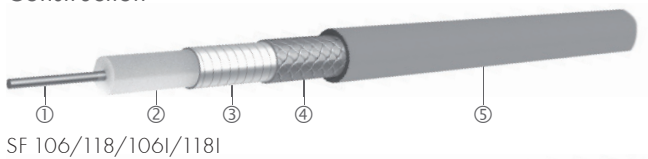

SF 106/118/106I/118I

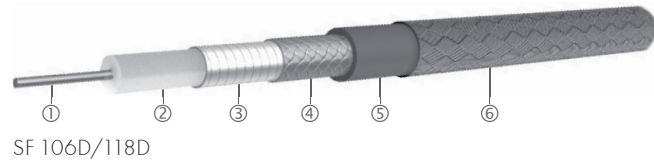

SF 106D/118D

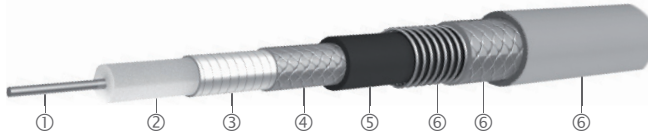



SF 106A/118A

Cable	Inner conductor ①	Dielectric ②	Outer conductor ③ ④	Jacket ⑤	Ruggedisation ⑥	Outer diameter mm
SUCOFLEX_106	CuAg wire	LD-PTFE	CuAg tape/braid	FEP, blue	no	7.9
SUCOFLEX_106_D	CuAg wire	LD-PTFE	CuAg tape/braid	FEP	aramid yarn braid, blue	8.3
SUCOFLEX_106_I	CuAg wire	LD-PTFE	CuAg tape/braid	LSFH, black	no	8.2
SUCOFLEX_106_A	CuAg wire	LD-PTFE	CuAg tape/braid	FEP	stainless steel/ PUR, black	13.2
SUCOFLEX_118	CuAg strand low loss	LD-PTFE	CuAg tape/braid	FEP, blue	no	7.9
SUCOFLEX_118_A	CuAg strand low loss	LD-PTFE	CuAg tape/braid	FEP	stainless steel/ PUR, black	13.2
SUCOFLEX_118_D	CuAg strand low loss	LD-PTFE	CuAg tape/braid	FEP	aramid yarn braid, black	8.3
SUCOFLEX_118_I	CuAg strand low loss	LD-PTFE	CuAg tape/braid	LSFH, black	no	8.2

# SUCOFLEX® 106 / 118

## Assembly types

		SUCOFLEX 106	SUCOFLEX 106I	SUCOFLEX 118	SUCOFLEX 118I	SUCOFLEX 106D	SUCOFLEX 118D	SUCOFLEX 106A	SUCOFLEX 118A
Construction									
Max. operating frequency	GHz	18	18	18	18	18	18	18	18
Application		static	static	dynamic	dynamic	static	dynamic	static	dynamic
Velocity of propagation	%	77	77	77	77	77	77	77	77
Weight	g/m	145	146	145	146	157	157	224	224
Min. bending radius static	mm	24	24	24	24	26	26	50	50
Min. bending radius repeated	mm	40	40	40	40	45	45	70	70
Temperature range	°C	-55 to +125	-40 to +85	-55 to +125	-40 to +85	-55 to +125	-55 to +125	-40 to +85	-40 to +85
Crush resistance	kN/m	12	12	12	12	12	12	60	60
Tensile load	N	400	400	400	400	400	400	400	400
Inner conductor		solid wire	solid wire	strand - low loss	strand - low loss	solid wire	strand - low loss	solid wire	strand - low loss
Dielectric		LD-PTFE	LD-PTFE	LD-PTFE	LD-PTFE	LD-PTFE	LD-PTFE	LD-PTFE	LD-PTFE
Outer conductor		tape/braid	tape/braid	tape/braid	tape/braid	tape/braid	tape/braid	tape/braid	tape/braid
Jacket		FEP	LSFH	FEP	LSFH	FEP	FEP	FEP	FEP
Ruggedisation		no	no	no	no	aramid yarn braid	aramid yarn braid	stainless steel/PUR	stainless steel/PUR
Outer diameter	mm	7.9	8.2	7.9	8.2	8.3	8.3	13.2	13.2
Screening effectiveness (up to 18 GHz)	dB	> 90	> 90	> 90	> 90	> 90	> 90	> 90	> 90
Phase stability vs. flexure (360°, diameter 85 mm)	°eI/ GHz	< 2.0	< 2.0	< 1.2	< 1.2	< 2.0	< 1.2	< 2.0	< 1.2
Phase stability vs. temperature (-40 to +85 °C)	ppm	< 1500	< 1500	< 1500	< 1500	< 1500	< 1500	< 1500	< 1500
Assembly phase matching tolerances	°eI/ GHz	± 0.5	± 0.5	± 0.5	± 0.5	± 0.5	± 0.5	± 0.5	± 0.5
Cable attenuation at 25 °C	dB/m	see graph	see graph	see graph	see graph	see graph	see graph	see graph	see graph
Insertion loss stability vs. bending	dB	± 0.2	± 0.2	± 0.2	± 0.2	± 0.2	± 0.2	± 0.2	± 0.2
Insertion loss stability vs. temperature	%/°C	< 0.2	< 0.2	< 0.2	< 0.2	< 0.2	< 0.2	< 0.2	< 0.2
Insertion loss stability vs. shaking	dB	± 0.1	± 0.1	± 0.1	± 0.1	± 0.1	± 0.1	± 0.1	± 0.1
Power handling	watt	see graph	see graph	see graph	see graph	see graph	see graph	see graph	see graph

# SUCOFLEX<sup>®</sup> 106 / 118

Attenuation (nominal values at +25 °C ambient temperature)

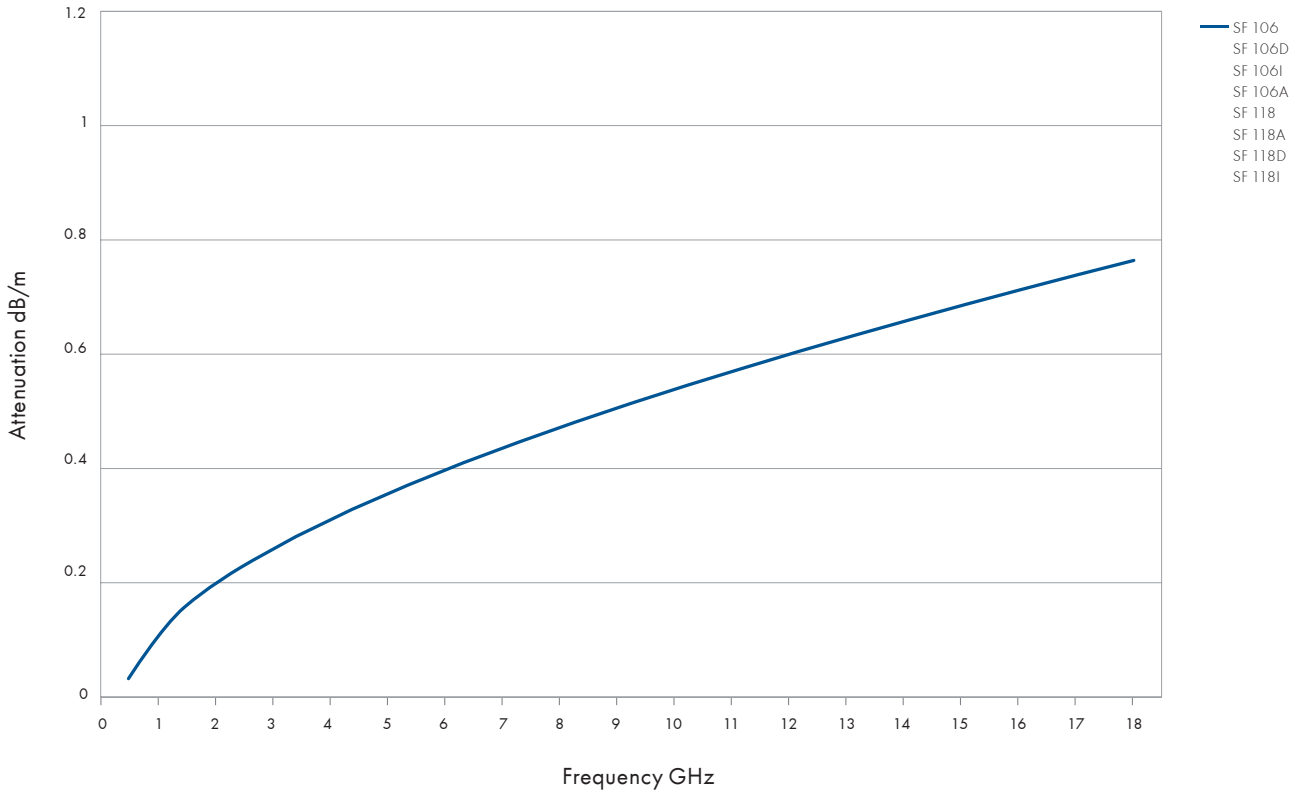

Power handling (maximum values at 25 °C ambient temperature and sea level)

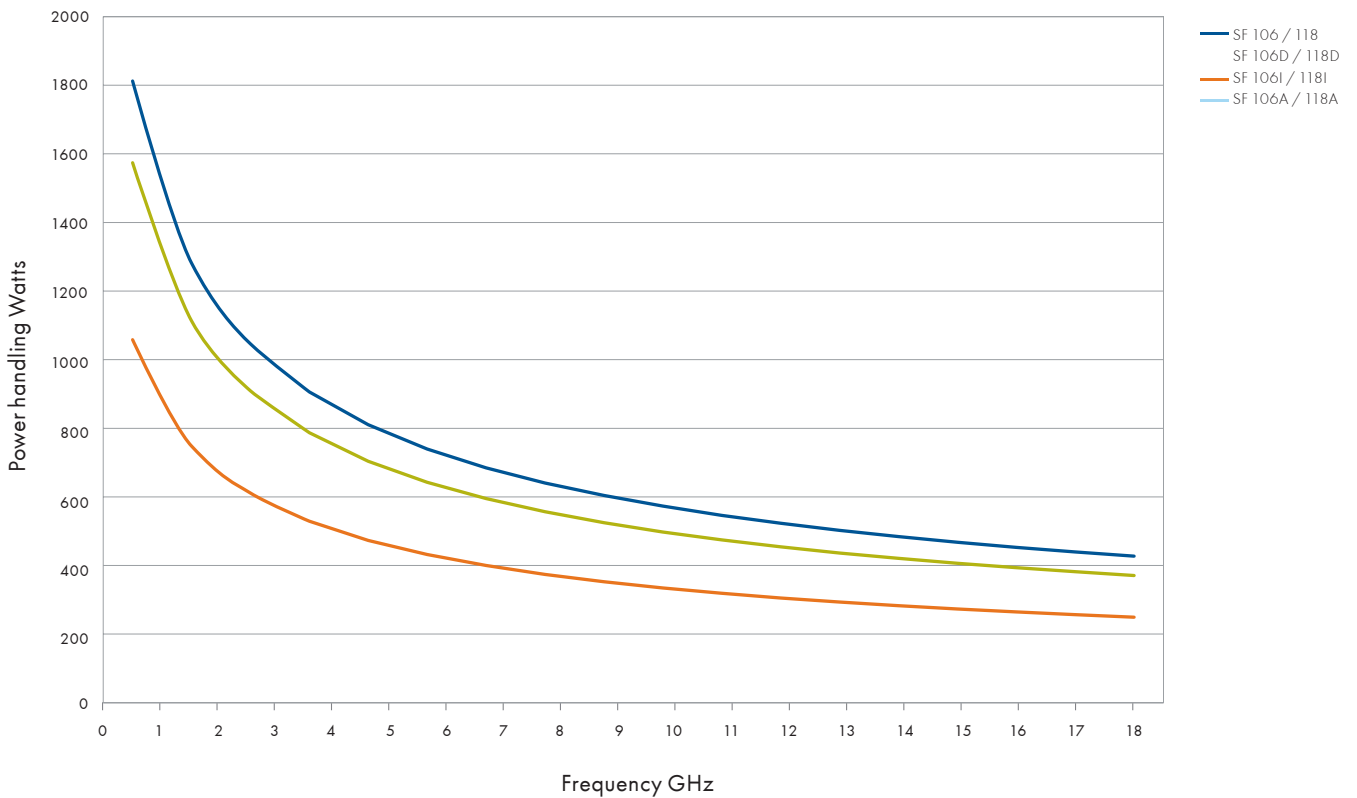

# SUCOFLEX® 106 / 118

## Available connectors

Connector	Series, pattern	HUBER+SUHNER connector type	SF106	SF106A	SF106D	SF106I	SF118	SF118A	SF118D	SF118I	Operating frequency	VSWR per connector	Remarks
											GHz		
N	straight cable plug	11_N-651	•	•	•	•					18	1.12	
	straight cable plug	11_N-656					•	•	•	•	18	1.12	
	right angle cable plug	16_N-651	•		•	•					11 18	1.12 1.22	
	right angle cable plug	16_N-653		•							11 18	1.12 1.22	
	right angle cable plug	16_N-656					•		•	•	11 18	1.12 1.22	MIL
	straight panel bulkhead cable jack	24_N-651	•	•	•	•					18	1.12	ML 12
	straight panel bulkhead cable jack	24_N-652					•		•	•	18	1.12	ML 12
QN	straight cable plug	11_QN-601	•			•					6	1.07	
SMA	straight cable plug	11_SMA-652	•	•	•	•					18	1.12	
	straight cable plug	11_SMA-656					•	•	•	•	18	1.12	
	right angle cable plug	16_SMA-652	•		•	•					18	1.22	
	straight cable jack	21_SMA-651	•	•	•						18	1.12	
	straight cable jack	21_SMA-652					•	•	•	•	18	1.12	
	straight panel bulkhead cable jack	24_SMA-651	•			•	•		•	•	18	1.12	ML 35
TNC	straight cable plug	11_TNC-651		•							18	1.16	
	straight cable plug	11_TNC-653	•		•	•					18	1.12	
	straight cable plug	11_TNC-654					•		•	•	18	1.12	
	right angle cable plug	16_TNC-651	•		•	•					18	1.22	
	right angle cable plug	16_TNC-653		•							18	1.22	
	right angle cable plug	16_TNC-655					•		•	•	18	1.22	
	straight cable jack	21_TNC-651	•		•	•					18	1.12	
	straight panel bulkhead cable jack	24_TNC-651		•							18	1.16	ML 4
	straight panel bulkhead cable jack	24_TNC-653	•		•	•					18	1.12	ML 4
7/16	straight cable plug	11_716-61	•	•	•	•					7.5	1.12	
	straight cable jack	21_716-61	•	•	•	•					7.5	1.12	

# Overview SUCOFLEX® 200

The loss revolution for dynamic applications

## Product description

The tape wrapped SUCOFLEX 200 microwave cable assemblies have been specifically developed for high performance and anywhere the best insertion loss, high phase stability versus temperature, excellent return loss and mechanical stability are of the utmost importance.

## Product features

- Impedance 50 Ω
- Ultra low loss
- Phase stable vs. temperature
- Robust mechanical construction designed for dynamic applications
- Phase stable vs. bending
- Operating frequency up to 40 GHz
- Velocity of propagation 82 %
- MIL-DTL-17 qualified
- Stock assemblies available



## Recommended connectors

SF229	SMA, SK, TNC, N
SF240	SMA, SK
	Other connectors available on request

## Technical data

HUBER+SUHNER cable type	Operating frequency	Temperature range	Outer diameter	Nominal attenuation 18 GHz, 25 °C	Bending radii		Weight	More information see page
	GHz	°C	mm	dB/m	static mm	repeated mm	g/m	
SUCOFLEX 229	29	-55 to +125	5.1	1.0	23	70	61	39
SUCOFLEX 240	40	-55 to +125	4.2	1.6	8.4	25	37	43

# SUCOFLEX® 229

The loss revolution for dynamic applications

## Product description – benefits

- Improved system performance due to reduced phase change over temperature
- Higher signal integrity due to lower loss
- Fully MIL/DTL-17 qualified
- Excellent performance to price ratio
- Stock assemblies available

## Product features

- Impedance 50 Ω
- Applicable up to 29 GHz
- For static and dynamic applications
- Ultra low loss
- Outstanding phase stability
- Excellent return loss



## Recommended connectors

SF229	SMA, TNC, N, SK
	Other connectors available on request

## Construction

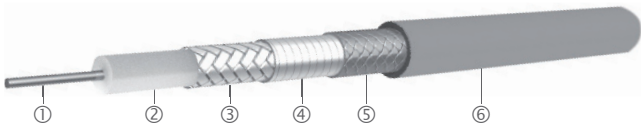

SF 229

Cable	Inner conductor ①	Dielectric ②	Outer conductor ③	Barrier ④	Outer braid ⑤	Jacket ⑥	Outer diameter
							mm
SUCOFLEX_229	CuAg wire	PTFE microporous	CuAg flat wire braid	aluminium/polyimide tape	CuAg	FEP, clear	5.1



# SUCOFLEX 229

## Assembly types

		SUCOFLEX_229
Construction		
Max. operating frequency	GHz	29
Application		static and dynamic
Velocity of propagation	%	82
Weight	g/m	61
Min. bending radius static	mm	23
Min. bending radius repeated	mm	70
Temperature range	°C	-55 to +125 (-65 to +200 °C on request)
Tensile load	N	133
Inner conductor		solid wire
Dielectric		PTFE microporous
Outer conductor		flat wire braid
Barrier		tape/braid
Jacket		FEP
Ruggedisation		no
Outer diameter	mm	5.1
Screening effectiveness (up to 18 GHz)	dB	> 90
Phase stability vs. flexure (360°, diameter 55 mm)	°el/GHz	< 0.65
Phase stability vs. temperature (-40 to +85 °C)	ppm	< 600
Assembly phase matching tolerances	°el/GHz	± 0.5
Cable attenuation at 25 °C	dB/m	see graph
Insertion loss stability vs. bending	dB	± 0.2
Insertion loss stability vs. temperature	%/°C	< 0.21
Power handling	watt	see graph
Ruggedisation		on request

# SUCOFLEX<sup>®</sup> 229

Attenuation (nominal values at +25 °C ambient temperature)

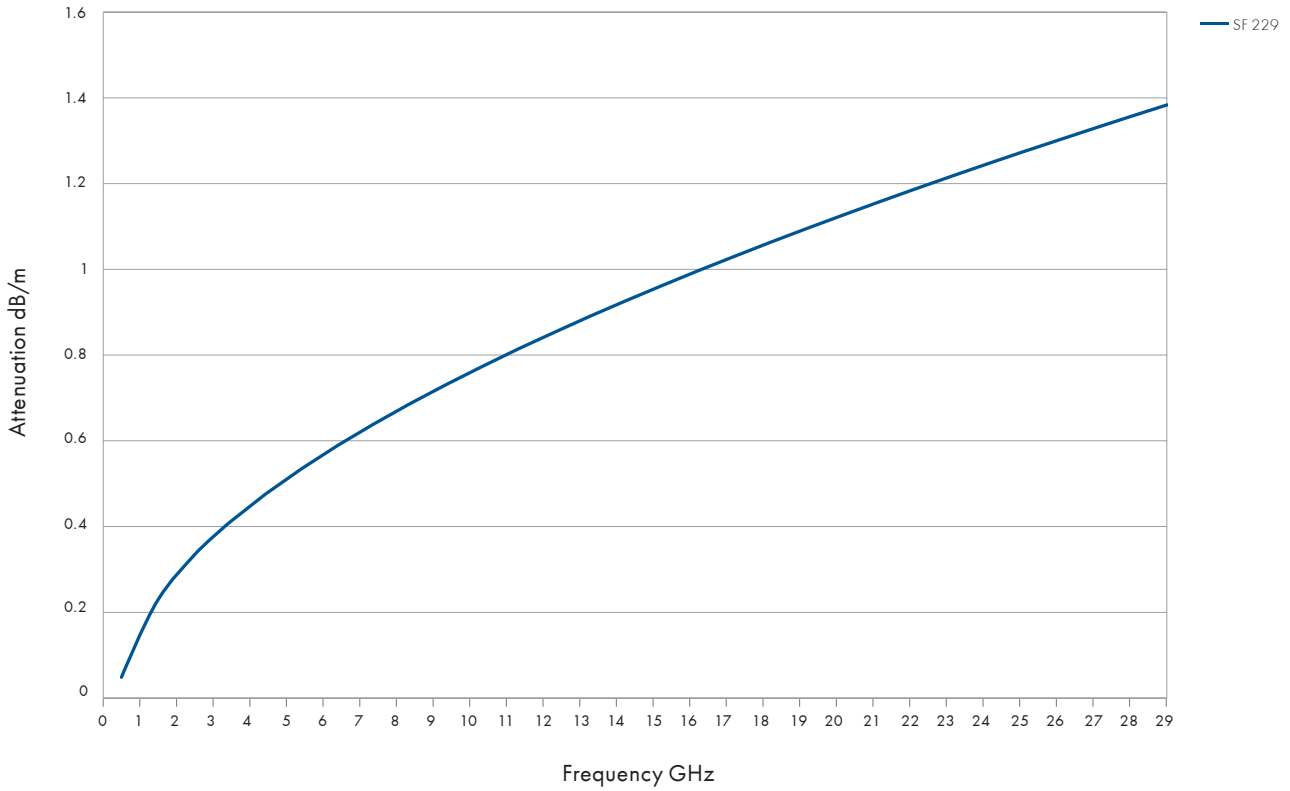

Power handling (maximum values at 25 °C ambient temperature and sea level)

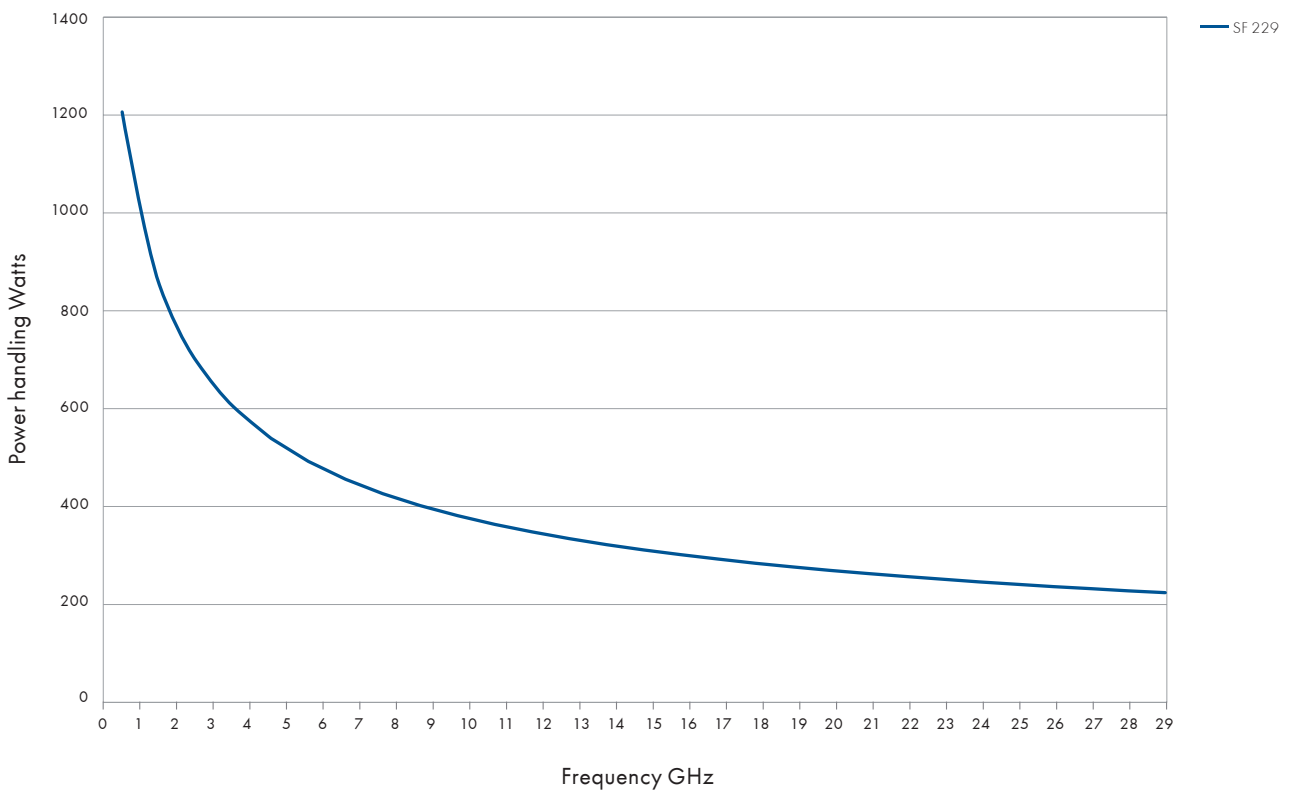

# SUCOFLEX® 229

## Available connectors

Connector	Series, pattern	HUBER+SUHNER connector type	SF229	Operating frequency GHz	VSWR per connector
SMA	straight cable plug	29094HT	•	26.5	1.14
SK	straight cable plug	29094KHT	•	29	1.14
N	straight cable plug	29080HT	•	18	1.14
TNC	straight cable plug	29714HT	•	18	1.14

## Stock assemblies

Item no.	Type	Length mm	Frequency GHz	Max. insertion loss at 25 °C dB	Max. VSWR	RoHS compliant
<b>SUCOFLEX_229</b>						
80395241	SF229/SK <sub>m</sub> /SK <sub>m</sub> /36 inch	914	29	1.84	1.30	yes
80395242	SF229/SK <sub>m</sub> /SK <sub>m</sub> /48 inch	1219	29	2.30	1.30	yes
80395243	SF229/SK <sub>m</sub> /SK <sub>m</sub> /72 inch	1829	29	3.20	1.30	yes
80395250	SF229/SMA <sub>m</sub> /SMA <sub>m</sub> /36 inch	914	26.5	1.71	1.30	yes
80395251	SF229/SMA <sub>m</sub> /SMA <sub>m</sub> /48 inch	1219	26.5	2.14	1.30	yes
80395252	SF229/SMA <sub>m</sub> /SMA <sub>m</sub> /72 inch	1829	26.5	2.96	1.30	yes
80395256	SF229/TNC <sub>m</sub> /TNC <sub>m</sub> /36 inch	914	18	1.42	1.30	yes
80395257	SF229/TNC <sub>m</sub> /TNC <sub>m</sub> /48 inch	1219	18	1.77	1.30	yes
80395258	SF229/TNC <sub>m</sub> /TNC <sub>m</sub> /72 inch	1829	18	2.44	1.30	yes
80395253	SF229/N <sub>m</sub> /N <sub>m</sub> /36 inch	914	18	1.37	1.30	yes
80395254	SF229/N <sub>m</sub> /N <sub>m</sub> /48 inch	1219	18	1.72	1.30	yes
80395255	SF229/N <sub>m</sub> /N <sub>m</sub> /72 inch	1829	18	2.39	1.30	yes

# SUCOFLEX® 240

The loss revolution for dynamic applications

## Product description

- Improved system performance due to reduced phase change over temperature
- Higher signal integrity due to lower loss
- Fully MIL/DTL-17 qualified
- Excellent performance to price ratio
- Stock assemblies available

## Product features

- Impedance 50 Ω
- Applicable up to 40 GHz
- For static and dynamic applications
- Ultra low loss
- Outstanding phase stability
- Excellent return loss



## Recommended connectors

SF240	SMA, SK
	Other connectors available on request

## Construction

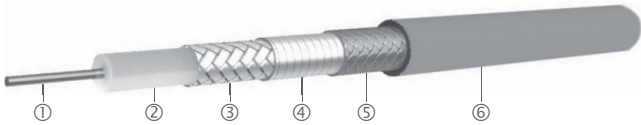

Cable	Inner conductor ①	Dielectric ②	Outer conductor ③	Barrier ④	Outer braid ⑤	Jacket ⑥	Ruggedisation ⑦	Outer diameter
SUCOFLEX_240	CuAg wire	PTFE microporous	CuAg flat wire braid	aluminium/ polyimide tape	CuAg	FEP, clear	no	mm 4.2

## Available connectors

Connector	Series, pattern	HUBER+SUHNER connector type	SF240	Operating frequency	VSWR per connector
				GHz	
SK	straight cable plug	29094K	•	40	1.14
SMA	straight cable plug	29094	•	26.5	1.14

# SUCOFLEX<sup>®</sup> 240

## Assembly types

		SUCOFLEX 240
Construction		
Max. operating frequency	GHz	40
Application		static and dynamic
Velocity of propagation	%	82
Weight	g/m	31
Min. bending radius static	mm	8.4
Min. bending radius repeated	mm	25
Temperature range	°C	-55 to +125 (-65 to +200 on request)
Tensile load	N	133
Inner conductor		solid wire
Dielectric		PTFE microporous
Outer conductor		flat wire braid
Barrier		tape/braid
Jacket		FEP
Outer diameter	mm	4.2
Screening effectiveness (up to 18 GHz)	dB	> 90
Phase stability vs. flexure (360°, diameter 55 mm)	°el/GHz	< 0.65
Phase stability vs. temperature (-40 to +85 °C)	ppm	< 600
Assembly phase matching tolerances	°el/GHz	± 0.5
Cable attenuation at 25 °C	dB/m	see graph
Insertion loss stability vs. bending	dB	± 0.2
Insertion loss stability vs. temperature	%/°C	< 0.21
Power handling	watt	see graph
Ruggedisation		on request

# SUCOFLEX<sup>®</sup> 240

Attenuation (nominal values at +25 °C ambient temperature)

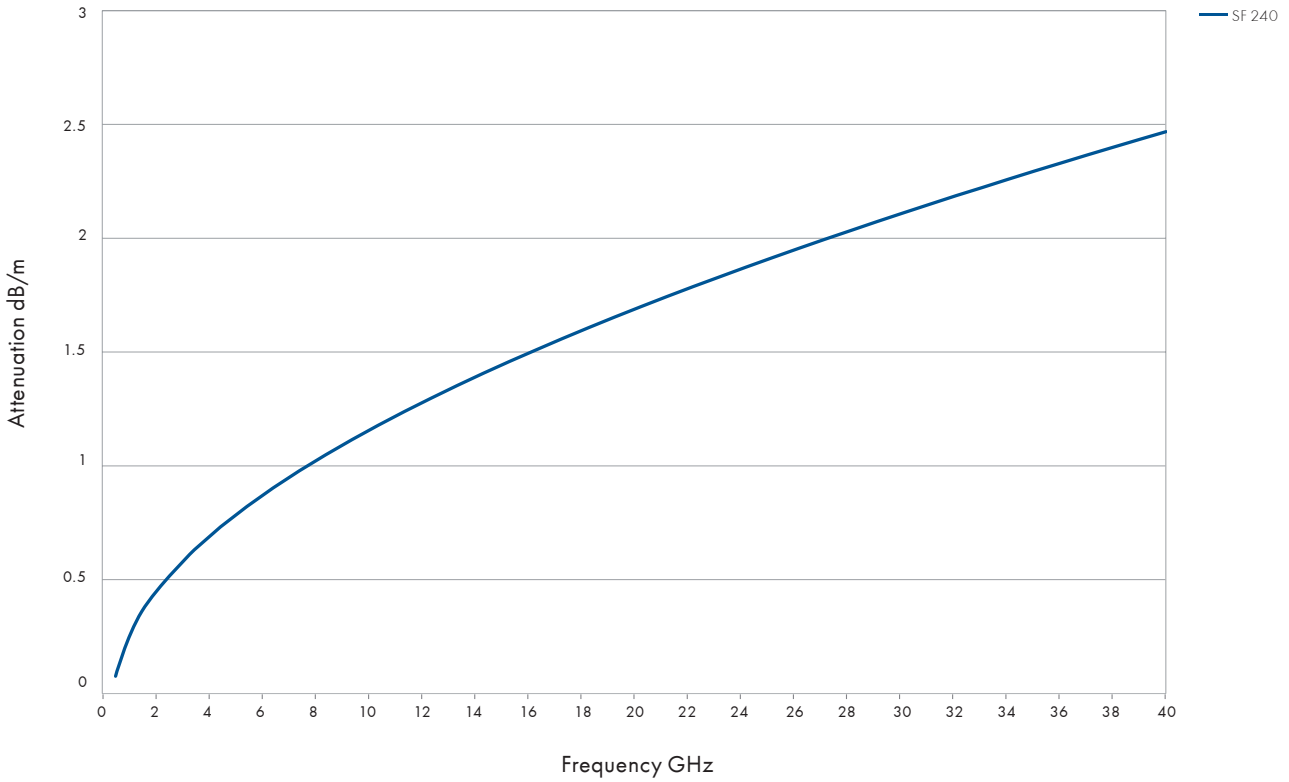

High performance

Power handling (maximum values at 25 °C ambient temperature and sea level)

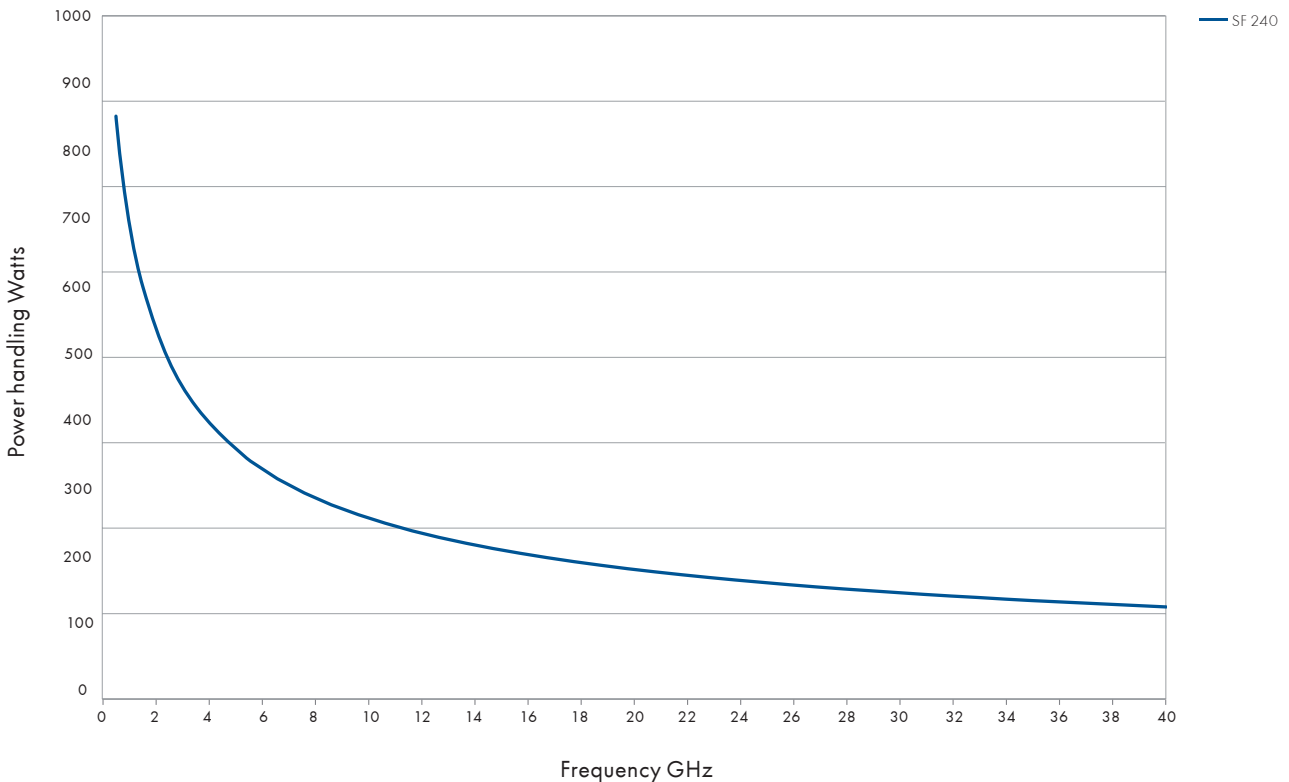

# Overview SUCOFLEX® 300

The light weight, high performance cable assembly

## Product description

The SUCOFLEX 300 lightweight, low-loss flexible microwave cable assemblies are high-end products designed to meet the stringent needs of space flight systems (e. g. satellites) and aerospace systems (aircraft, helicopters, missiles), which are subjected to extremely severe operating conditions. The 300 series offers a consistently outstanding mechanical and electrical performance, stability and reliability up to 40 GHz. The added feature of this SUCOFLEX type is a weight reduction of up to 50 % compared to our conventional products.



## Product features for space applications

- Assemblies produced in a clean environment room
- Specifically designed lightweight connectors
- Extensive testing of assemblies
- High-end assemblies approved by Europe's leading satellite manufacturers

## Product features for defense applications

- Lightweight reduces overall system weight and aids portability
- Rugged connectors made for easy serviceability
- Specialised range of connectors, which is being continuously extended
- Comprehensive tested product range
- High-end product approved for most sophisticated military aircraft
- Additional D-armour provide increased crush and abrasion resistance

## Recommended connectors

SF301 SF301_Space	SMA
SF302	SMA, SK, PC2.4
SF304 SF304_Space	SMA, N, TNC
SF307_Space	TNC
SF329	SMA, SK, TNC, N
SF340	SMA, SK
	Other connectors available on request

## Technical data

HUBER+SUHNER cable type	Operating frequency	Temperature range	Outer diameter	Nominal attenuation 18 GHz, 25 °C	Bending radii		Weight g	More information see page
	GHz	°C	mm	dB/m	static mm	repeated mm		
SUCOFLEX 301	18	-55 to +125	3.5	2.0	15	20	23.9	47
SUCOFLEX 301_Space	18	-55 to +150	3.5	2.0	15	20	23.9	47
SUCOFLEX 302	40	-55 to +125	3.7	1.9	15	30	29.0	50
SUCOFLEX 304	18	-55 to +125	5.4	1.2	20	50	46.0	54
SUCOFLEX 304_Space	18	-55 to +150	5.4	1.2	20	50	46.0	54
SUCOFLEX 307_Space	8	-55 to +150	9.0	0.4 at 8 GHz	50	100	133	57
SUCOFLEX 329	29	-65 to +165	5.1	1.0	23	70	42	60
SUCOFLEX 340	40	-65 to +165	4.2	1.6	8.4	25	18	63



# SUCOFLEX® 301

The light weight, high performance microwave cable assembly working up to 18 GHz

High performance

## Product description

The SUCOFLEX 301 light weight, high end cable assemblies are designed to provide optimal performance up to 18 GHz were light weight, stringent electrical requirements - in particular stability and low loss, are important.



## Product features

- Impedance 50 Ω
- Applicable up to 18 GHz
- Up to 40 % weight reduction compared to standard SUCOFLEX 101 assemblies (lower launching costs)
- Production in clean room
- All space connectors vented
- Outgassing according ECSS-Q-ST-70-02C and NASA reference publication 1124
- MIL-DTL-17 qualified
- Low loss

## Recommended connectors

SF301	SMA
SF301_Space	
Other connectors available on request	

## Construction

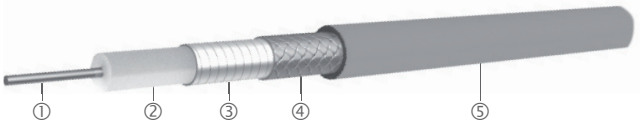

Cable	Inner conductor ①	Dielectric ②	Outer conductor ③ ④	Jacket ⑤	Outer diameter
					mm
SUCOFLEX_301	AlCuAg wire	LD-PTFE	CuAg tape/AlCuAg braid	ETFE, blue	3.5
SUCOFLEX_301_Space	AlCuAg wire	LD-PTFE	CuAg tape/AlCuAg braid	ETFE, blue	3.5

Other SUCOFLEX 301 cables available on request.

## Available connectors

Connector	Series, pattern	HUBER+SUHNER connector type	SF301	SF301_Space	Op. freq.	VSWR per connector	Remarks
					GHz		
SMA	straight cable plug	11_SMA-153	•		18	1.12	
	straight cable plug	11_SMA-187_Space		•	12 18	1.07 1.12	vented
	right angle cable plug	16_SMA-189_Space		•	12 18	1.07 1.12	vented

# SUCOFLEX® 301

## Assembly types

		SUCOFLEX 301	SUCOFLEX 301_Space
Construction			
Max. operating frequency	GHz	18	18
Application		static	static
Velocity of propagation	%	77	77
Weight	g/m	23.9	23.9
Min. bending radius static	mm	15	15
Min. bending radius repeated	mm	20	20
Temperature range	°C	-55 to +125	-55 to +150
Tensile load	N	100	100
Inner conductor		solid wire	solid wire
Dielectric		LD-PTFE	LD-PTFE
Outer conductor		tape/braid	tape/braid
Jacket		ETFE	ETFE
Outer diameter	mm	3.5	3.5
Screening effectiveness (up to 18 GHz)	dB	> 90	> 90
Phase stability vs. flexure (360°, diameter 40 mm)	°el/GHz	< 1.5	< 1.5
Phase stability vs. temperature (-40 to +85 °C)	ppm	< 1500	< 1500
Assembly phase matching tolerances	°el/GHz	± 0.5	± 0.5
Cable attenuation at 25 °C	dB/m	see graph	see graph
Insertion loss stability vs. bending	dB	± 0.2	± 0.2
Insertion loss stability vs. temperature	%/°C	< 0.2	< 0.2
Insertion loss stability vs. shaking	dB	± 0.1	± 0.1
Power handling	watt	see graph	see graph
Radiation-gamma	Mrad	n/a	30
Connectors vented		no	yes
Out gassing according ECSS-Q_ST-70-02 and NASA reference publication 1124		no	TML < 1 %, CVCM < 0.1 %
Soldering according to ESA qualified materials and processes		no	ECSS-Q-70-08A and ECSS-Q-70-18A
Assembling in clean room		no	general: class 10 000 working area: class 100

# SUCOFLEX® 301

Attenuation (nominal values at +25 °C ambient temperature)

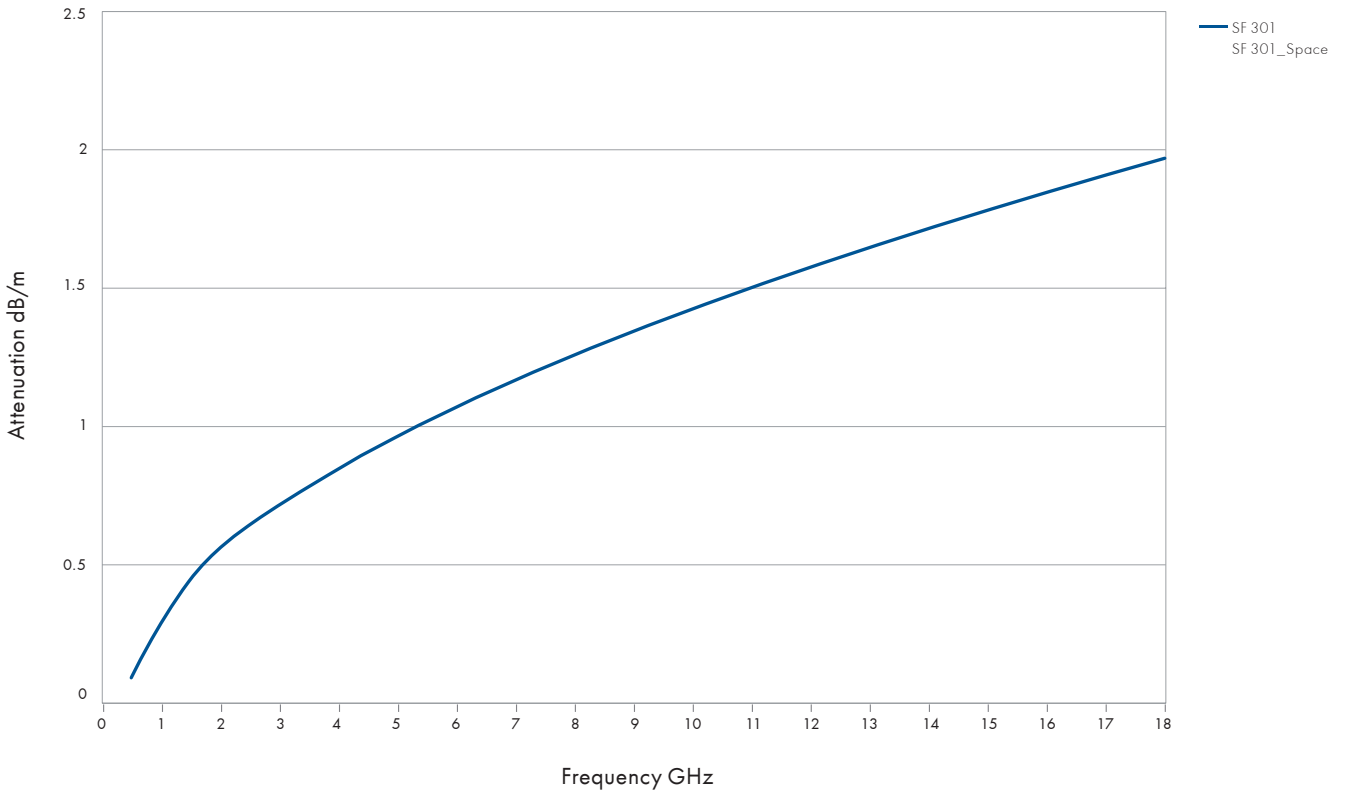

High performance

Power handling (maximum values at 25 °C ambient temperature and sea level)

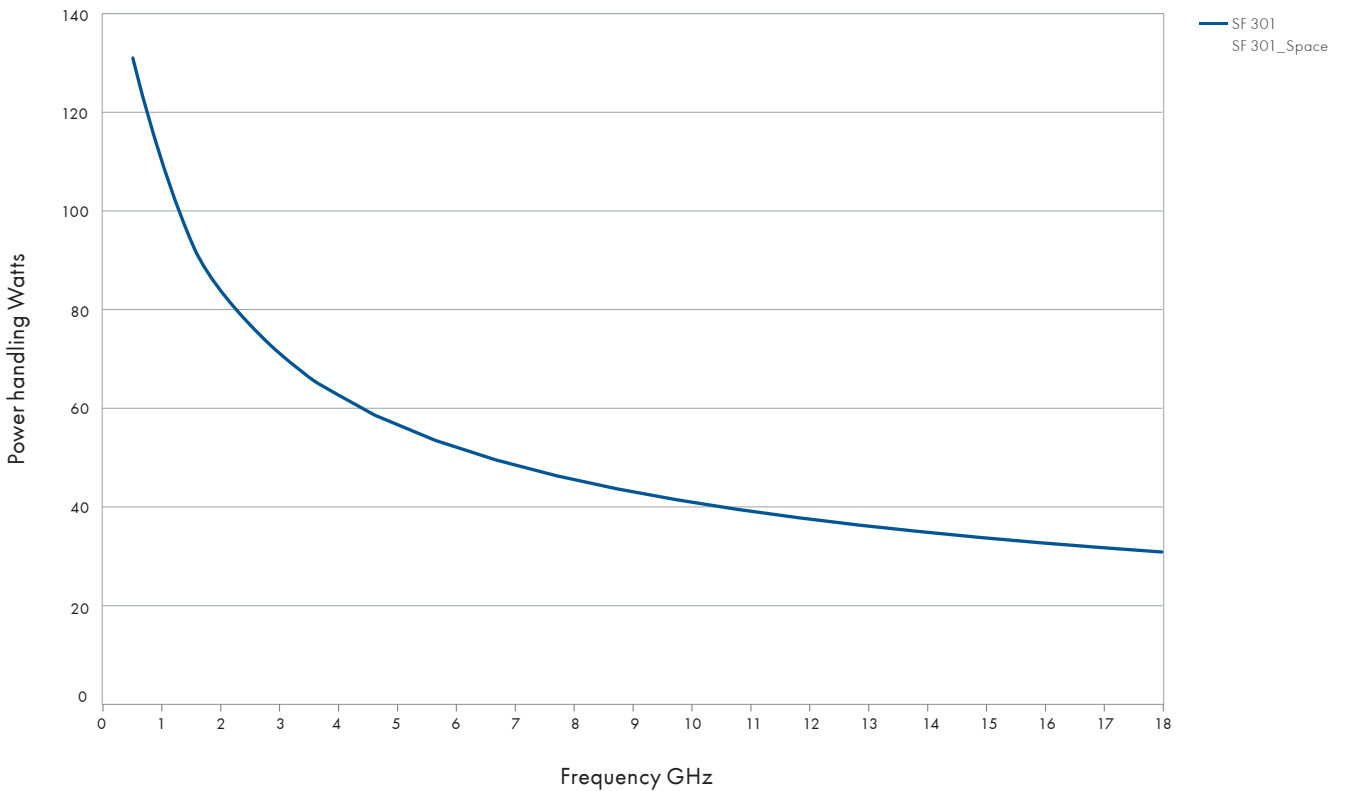

# SUCOFLEX® 302

The light weight, high performance microwave cable assembly working up to 40 GHz

## Product description

The SUCOFLEX 302 light weight, high end cable assemblies are designed to provide optimal performance up to 40 GHz where light weight, stringent electrical requirements - in particular stability and low loss, are important.



## Product features

- Impedance 50 Ω
- Applicable up to 40 GHz
- Up to 35 % weight reduction compared to standard SUCOFLEX 102 assemblies
- High reliability and stability
- Low loss

## Recommended connectors

SF302 SF302D	SMA, SK, PC2.4, PC3.5, TNC, N
	Other connectors available on request

## Construction

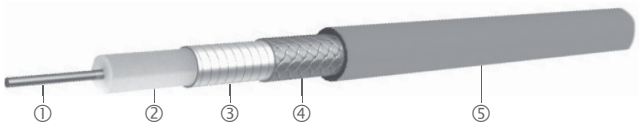

SF 302

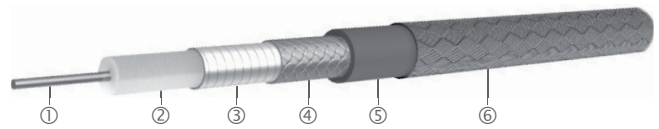



SF 302\_D

Cable	Inner conductor ①	Dielectric ②	Outer conductor ③ ④	Jacket ⑤	Ruggedisation ⑥	Outer diameter mm
SUCOFLEX_302	AlCuAg wire	LD-PTFE	CuAg tape/ AlCuAg braid	ETFE, blue	no	3.7
SUCOFLEX_302_D	AlCuAg wire	LD-PTFE	CuAg tape/ AlCuAg braid	ETFE	aramid yarn braid, blue	4.3

Other SUCOFLEX 302 cables available on request.

# SUCOFLEX® 302

## Assembly types

		SUCOFLEX 302	SUCOFLEX 302D
Construction			
Max. operating frequency	GHz	40	40
Application		static	static
Velocity of propagation	%	77	77
Weight	g/m	29	31
Min. bending radius static	mm	15	15
Min. bending radius repeated	mm	30	30
Temperature range	°C	-55 to +125	-55 to +125
Tensile load	N	150	150
Inner conductor		solid wire	solid wire
Dielectric		LD-PTFE	LD-PTFE
Outer conductor		tape/braid	tape/braid
Jacket		ETFE	ETFE
Ruggedisation		no	aramid yarn braid
Outer diameter	mm	3.7	4.3
Screening effectiveness (up to 18 GHz)	dB	> 90	> 90
Phase stability vs. flexure (360°, diameter 40 mm)	°el/GHz	< 1.5	< 1.5
Phase stability vs. temperature (-40 to +85 °C)	ppm	< 1500	< 1500
Assembly phase matching tolerances	°el/GHz	± 0.5	± 0.5
Cable attenuation at 25 °C	dB/m	see graph	see graph
Insertion loss stability vs. bending	dB	± 0.2	± 0.2
Insertion loss stability vs. temperature	%/°C	< 0.2	< 0.2
Insertion loss stability vs. shaking	dB	± 0.1	± 0.1
Power handling	watt	see graph	see graph
Connectors vented		no	no
Assembling in clean room		no	no

# SUCOFLEX<sup>®</sup> 302

Attenuation (nominal values at +25 °C ambient temperature)

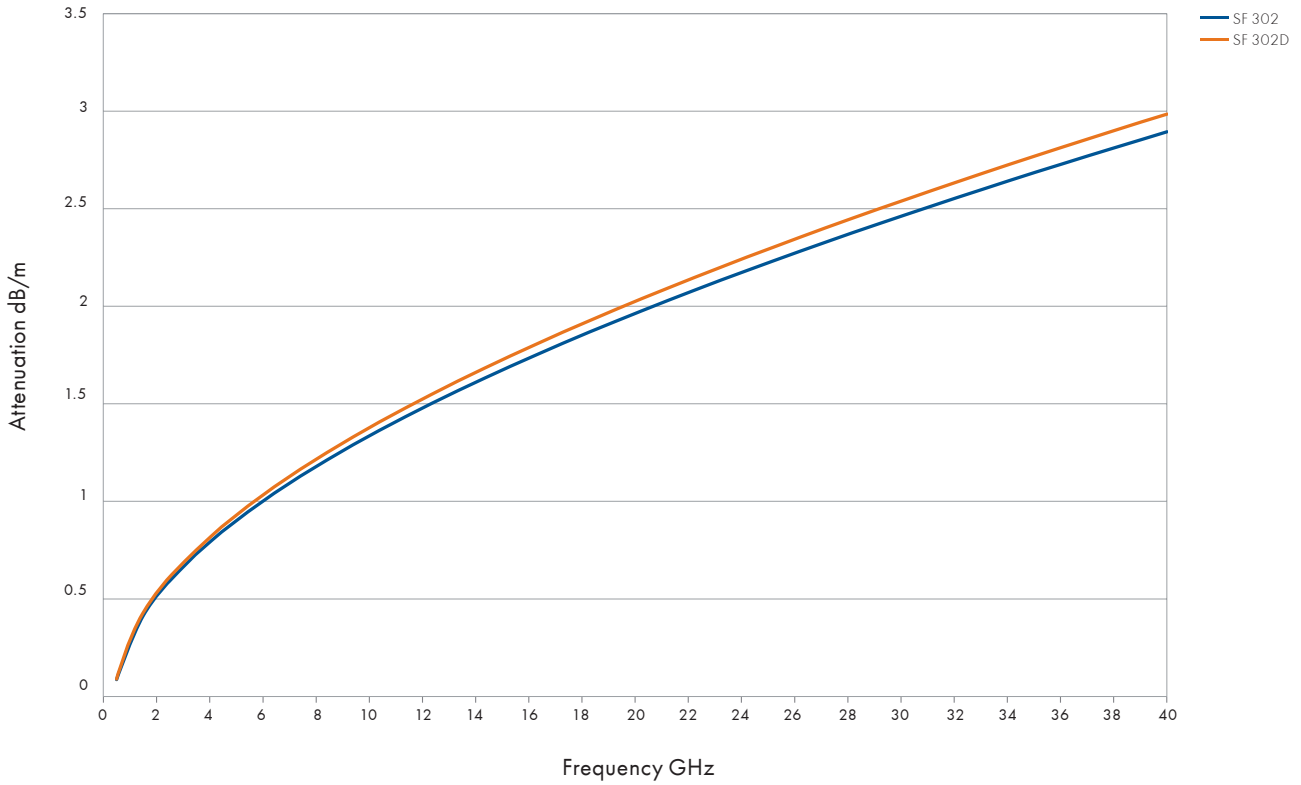

Power handling (maximum values at 25 °C ambient temperature and sea level)

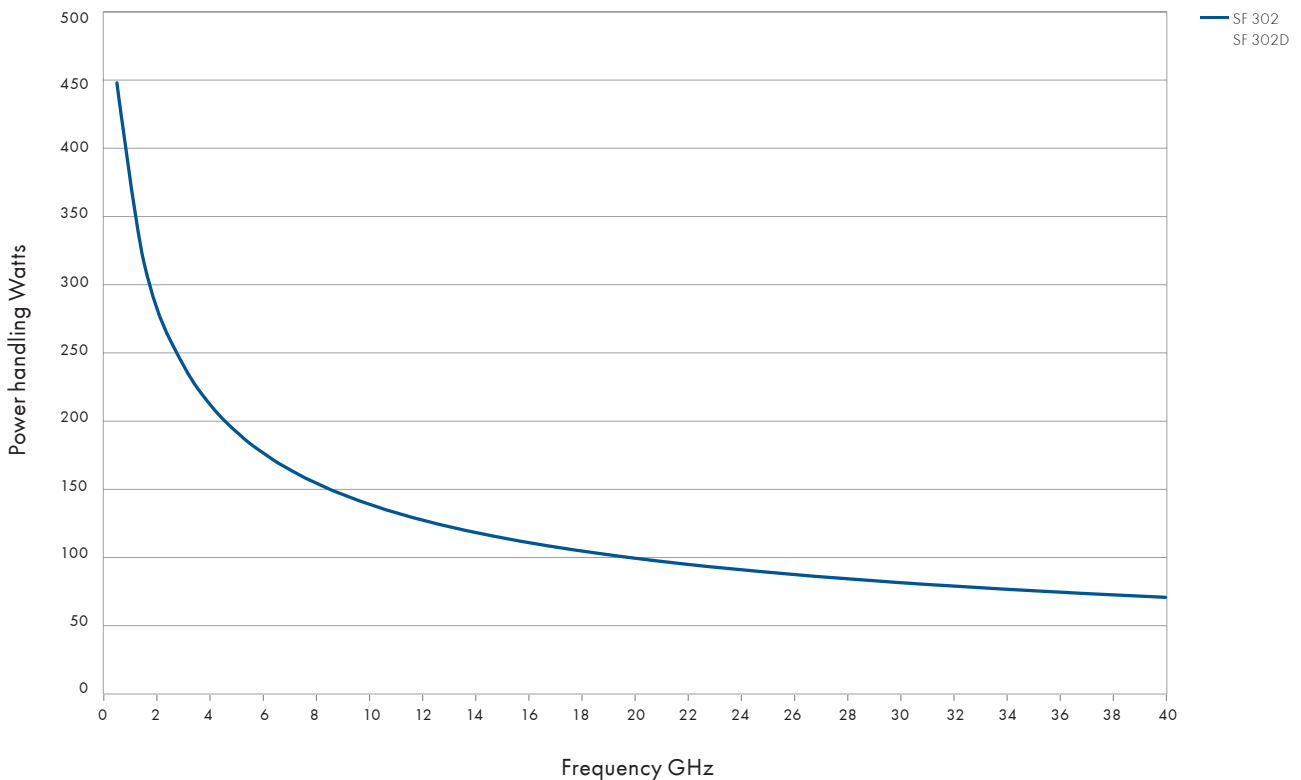

# SUCOFLEX® 302

## Available connectors

Connector	Series, pattern	HUBER+SUHNER connector type	SF302	SF302D	Operating frequency GHz	VSWR per connector	Remarks
SK	straight cable plug	11_SK-252	•	•	40	1.20	
	right angle cable plug	16_SK-252	•	•	40	1.20	
	straight cable jack	21_SK-252	•	•	40	1.20	
	straight panel bulkhead cable jack	24_SK-251	•	•	40	1.20	ML 35
N	straight cable plug	11_N-206	•	•	18	1.12	
PC 2.4	straight cable plug	11_PC2.4-201	•	•	40	1.20	
	straight cable jack	21_PC2.4-201	•	•	40	1.20	
	straight panel bulkhead cable jack	24_PC2.4-201	•	•	40	1.20	ML 38
PC 3.5	straight cable plug	11_PC3.5-203	•	•	26.5	1.16	
	straight cable jack	21_PC3.5-203	•	•	26.5	1.16	
SMA	straight cable plug	11_SMA-218	•	•	18 26.5	1.12 1.20	
	right angle cable plug	16_SMA-254	•	•	18	1.12	
	straight cable jack	21_SMA-204	•	•	18 26.5	1.12 1.20	
	straight panel bulkhead cable jack	24_SMA-210	•	•	18 26.5	1.12 1.20	ML 20
TNC	straight cable plug	11_TNC-222	•	•	18	1.12	
	straight panel bulkhead cable jack	24_TNC-222	•	•	18	1.12	ML 4

# SUCOFLEX® 304

The light weight, high performance microwave cable assembly working up to 18 GHz

## Product description

The SUCOFLEX 304 light weight, high end cable assemblies are designed to provide optimal performance up to 18 GHz were light weight, stringent electrical requirements - in particular stability and lowest loss, are important.

## Product features

- Impedance 50 Ω
- Applicable up to 18 GHz
- 45 % weight reduction compared to standard SUCOFLEX 104 assemblies (lower launching costs)
- Production in clean room
- All space connectors vented
- Outgassing according ECSS-Q-ST-70-02C and NASA reference publication 1124
- MIL-DTL-17 qualified

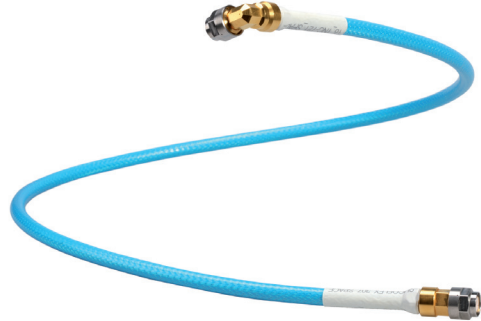

## Recommended connectors

SF304 SF304D SF304_Space	SMA, TNC
	Other connectors available on request

## Construction

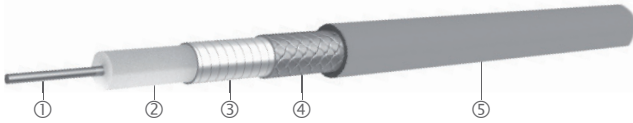

SF 304/SF 304\_Space

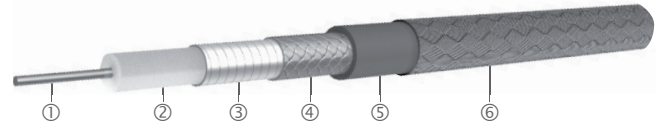

SF 304\_D

Cable	Inner conductor ①	Dielectric ②	Outer conductor ③ ④	Jacket ⑤	Ruggedisation ⑥	Outer diameter mm
SUCOFLEX_304	AlCuAg wire	LD-PTFE	CuAg tape/AlCuAg braid	ETFE, blue	no	5.4
SUCOFLEX_304_D	AlCuAg wire	LD-PTFE	CuAg tape/AlCuAg braid	ETFE	aramid yarn braid, blue	6.0
SUCOFLEX_304_Space	AlCuAg wire	LD-PTFE	CuAg tape/AlCuAg braid	ETFE, blue	no	5.4

Other SUCOFLEX 304 cables available on request.



## Available connectors

Connector	Series, pattern	HUBER+SUHNER connector type	SF304	SF304D	SF304_Space	Operating frequency GHz	VSWR per connector	Remarks
SMA	straight cable plug	11_SMA-459	•	•		18	1.12	
	straight cable plug	11_SMA-487_Space			•	18	1.12	vented
	right angle cable plug	16_SMA-489_Space			•	18	1.12	vented
	straight panel bulkhead cable jack	24_SMA-454	•	•		18	1.20	
TNC	straight cable plug	11_TNC-457	•	•		18	1.12	
	straight panel bulkhead cable jack	24_TNC-457	•	•		18	1.12	



# SUCOFLEX® 304

## Assembly types

		SUCOFLEX 304	SUCOFLEX 304_Space	SUCOFLEX 304D
Construction				
Max. operating frequency	GHz	18	18	18
Application		static	static	static
Velocity of propagation	%	77	77	77
Weight	g/m	46	46	56
Min. bending radius static	mm	20	20	20
Min. bending radius repeated	mm	50	50	50
Temperature range	°C	-55 to +125	-55 to +150	-55 to +125
Tensile load	N	250	250	250
Inner conductor		solid wire	solid wire	solid wire
Dielectric		LD-PTFE	LD-PTFE	LD-PTFE
Outer conductor		tape/braid	tape/braid	tape/braid
Jacket		ETFE	ETFE	ETFE
Ruggedisation		no	no	aramid yarn braid
Outer diameter	mm	5.4	5.4	6.0
Screening effectiveness (up to 18 GHz)	dB	> 90	> 90	> 90
Phase stability vs. flexure (360°, diameter 55 mm)	°el/GHz	< 1.5	< 1.5	< 1.5
Phase stability vs. temperature (-40 to +85 °C)	ppm	< 1500	< 1500	< 1500
Assembly phase matching tolerances	°el/GHz	± 0.5	± 0.5	± 0.5
Cable attenuation at 25 °C	dB/m	see graph	see graph	see graph
Insertion loss stability vs. bending	dB	± 0.1	± 0.1	± 0.1
Insertion loss stability vs. temperature	%/°C	< 0.2	< 0.2	< 0.2
Insertion loss stability vs. shaking	dB	± 0.1	± 0.1	± 0.1
Power handling	watt	see graph	see graph	see graph
Radiation-gamma	Mrad	n/a	30	n/a
Connectors vented		no	yes	no
Out gassing according ECSS-Q-ST-70-02 and NASA reference publication 1124		no	TML < 1 %, CVCM < 0.1 %	no
Soldering according to ESA qualified materials and processes		no	ECSS-Q-70-08A and ECSS-Q-70-18A	no
Assembling in clean room		no	general: class 10 000 working area: class 100	no

# SUCOFLEX<sup>®</sup> 304

Attenuation (nominal values at +25 °C ambient temperature)

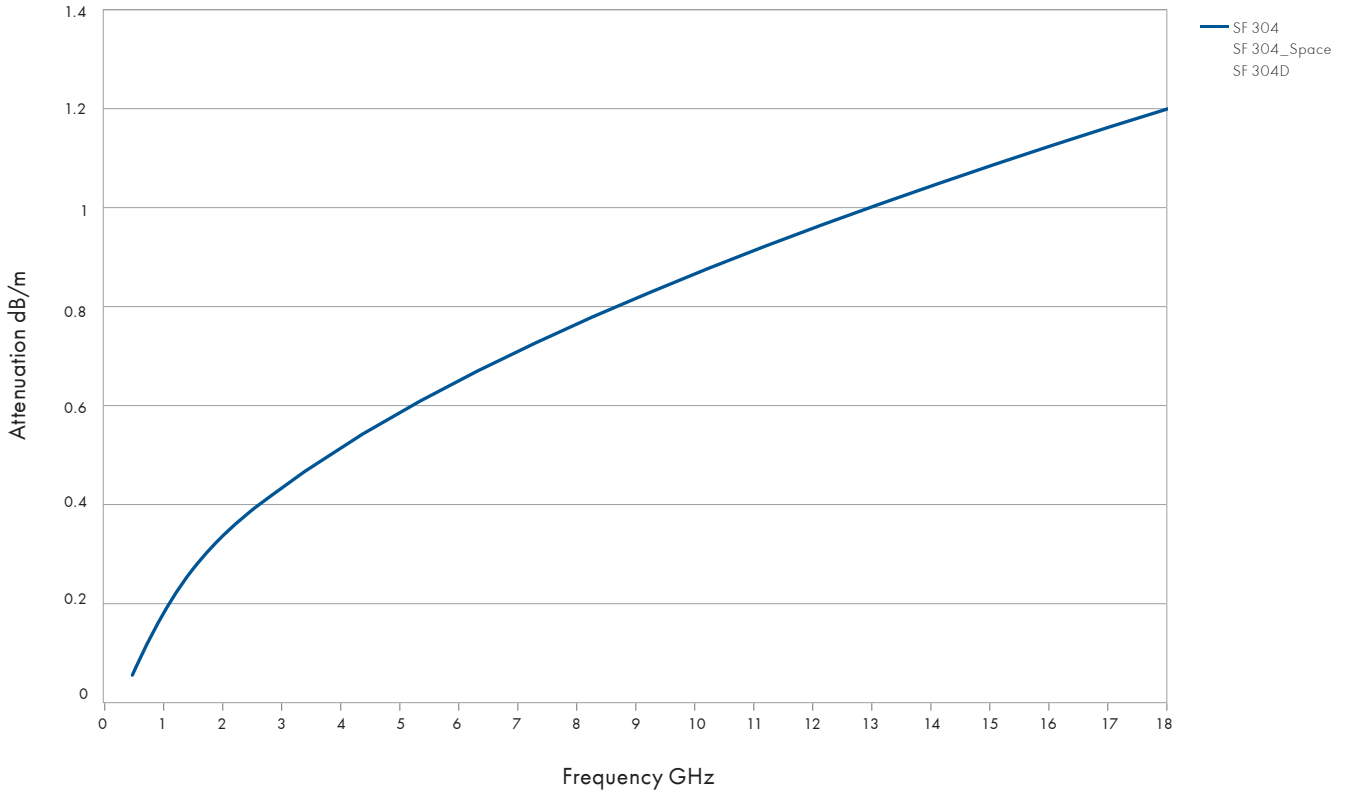

Power handling (maximum values at 25 °C ambient temperature and sea level)

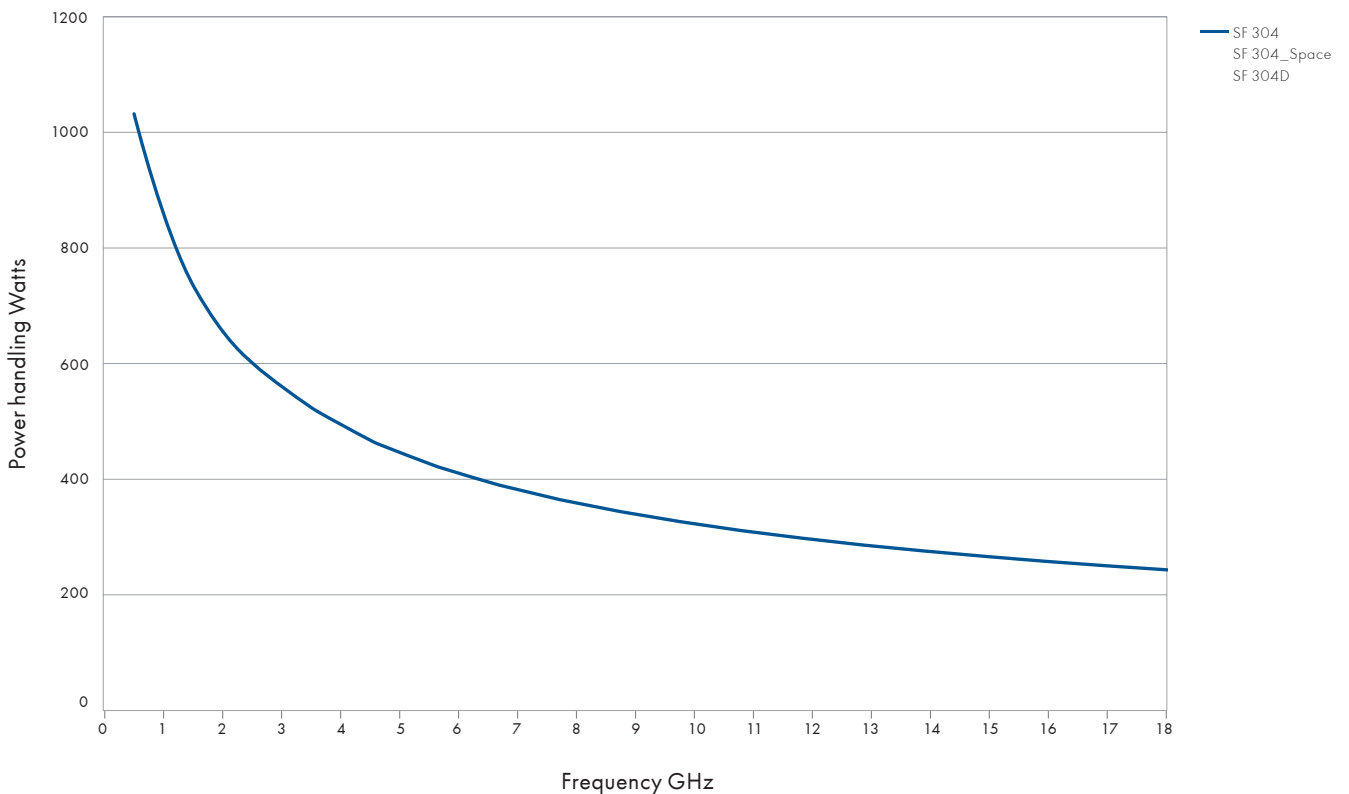

# SUCOFLEX® 307

The light weight, high performance microwave cable assembly working up to 8 GHz

## Product description

The SUCOFLEX 307 light weight, high end cable assemblies are designed to provide optimal performance up to 8 GHz where light weight, high power, stringent electrical requirements - in particular stability and low loss, are important.

## Product features

- Impedance 50 Ω
- Applicable up to 8 GHz
- High power application
- Centre conductor and braid in aluminum instead of copper
- Production in clean room
- Extensive testing of the assembly
- Customer specific qualification
- All connectors vented
- Outgassing according ECSS-Q-ST-70-02C and NASA reference publication 1124
- MIL-DTL-17 qualified
- Mechanical stability
- Low loss

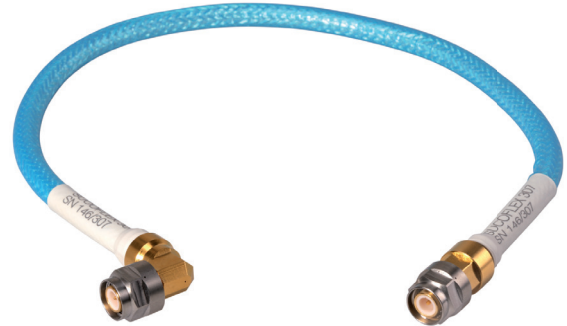

## Recommended connectors

SF307_Space	TNC
	Other connectors available on request

## Construction

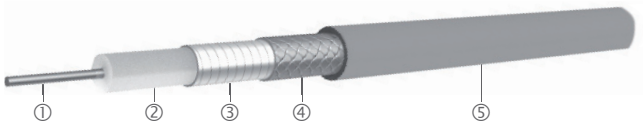

Cable	Inner conductor ①	Dielectric ②	Outer conductor ③ ④	Jacket ⑤	Outer diameter mm
SUCOFLEX_307_Space	AlCuAg wire	LD-PTFE	CuAg tape/AlCuAg braid	ETFE, blue	9.0

## Available connectors

Connector	Series, pattern	HUBER+SUHNER connector type	SF307_Space	Operating frequency GHz	VSWR per connector	Remarks
TNC	straight cable plug	11_TNC-721_Space	•	5.5	1.07	vented
	right angle cable plug	16_TNC-721_Space	•	5.5	1.07	vented

# SUCOFLEX® 307

## Assembly types

		SUCOFLEX 307_Space
Construction		
Max. operating frequency	GHz	8
Application		static
Velocity of propagation	%	77
Weight	g/m	133
Min. bending radius static	mm	50
Min. bending radius repeated	mm	100
Temperature range	°C	-55 to +150
Tensile load	N	340
Inner conductor		solid wire
Dielectric		LD-PTFE
Outer conductor		tape/braid
Jacket		ETFE
Outer diameter	mm	9.0
Screening effectiveness (up to 18 GHz)	dB	> 90
Phase stability vs. flexure (360°, diameter 125 mm)	°el/GHz	< 2.0
Phase stability vs. temperature (-40 to +85 °C)	ppm	< 1500
Assembly phase matching tolerances	°el/GHz	± 0.5
Cable attenuation at 25 °C	dB/m	see graph
Insertion loss stability vs. bending	dB	± 0.1
Insertion loss stability vs. temperature	%/°C	< 0.45
Insertion loss stability vs. shaking	dB	± 0.1
Power handling	watt	see graph
Radiation-gamma	Mrad	30
Connectors vented		yes
Out gassing according ECSS-Q_ST-70-02 and NASA reference publication 1124		TML < 1 %, CVCM < 0.1 %
Soldering according to ESA qualified materials and processes		ECSS-Q-70-08A and ECSS-Q-70-18A
Assembling in clean room		general: class 10 000 working area: class 100

# SUCOFLEX® 307

Attenuation (nominal values at +25 °C ambient temperature)

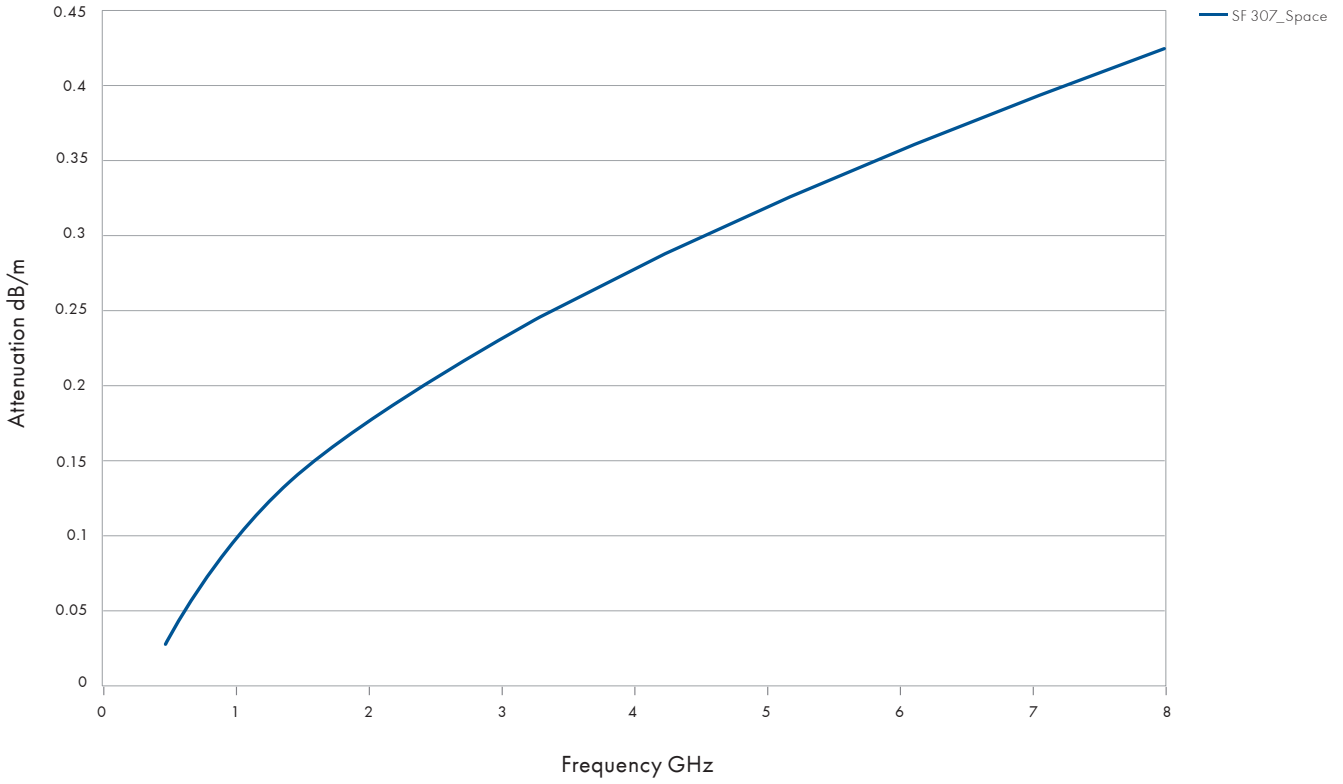

High performance

Power handling (maximum values at 25 °C ambient temperature and sea level)

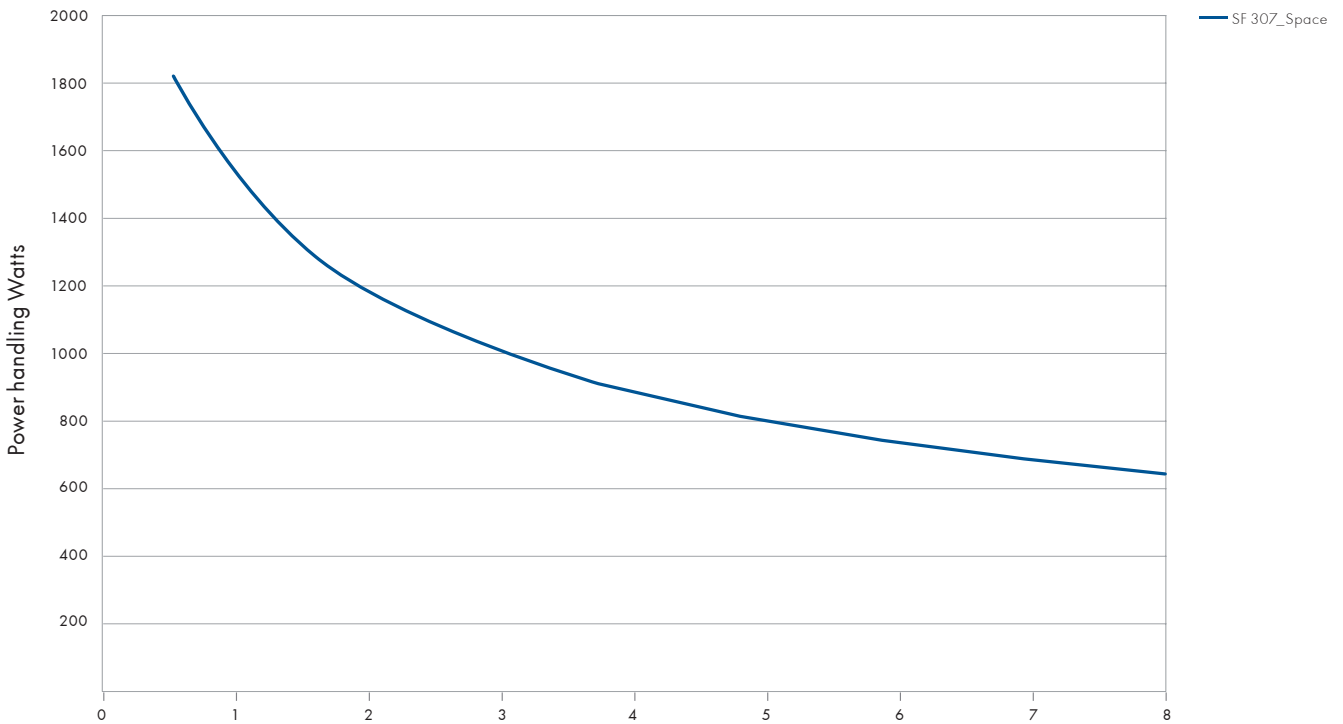

# SUCOFLEX® 329

Light weight, phase stable assembly for space and airborne applications

## Product description

The SUCOFLEX 329 offers a consistently outstanding mechanical and electrical performance, stability and reliability up to 29 GHz with triple shielding for improved screening attenuation. The added feature of this SUCOFLEX type is a weight reduction of up to 50 % compared to our conventional products.



## Product features

- Impedance 50 Ω
- Applicable up to 29 GHz
- Light weight
- MIL-DTL-17 qualified
- Low loss and high phase stability vs. temperature
- Outgassing free acc. ESA/NASA
- Standard and high radiation resistance version available

## Recommended connectors

SF329	SMA, SK, TNC, N
	Other connectors available on request

## Construction

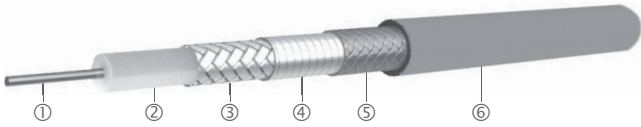

Cable	Inner conductor ①	Dielectric ②	Outer conductor ③	Barrier ④	Outer braid ⑤	Jacket ⑥	Outer diameter mm
SUCOFLEX_329	AlCuAg wire	PTFE microporous	CuAg flat wire braid	aluminium/ polyimide tape	AlCuAg	ECTFE, black	5.1

## Available connectors

Connector	Series, pattern	HUBER+SUHNER connector type	SF329	Operating frequency GHz	VSWR per connector
SK	straight cable plug	29094KPV	•	29	1.14
SMA	straight cable plug	29094PV	•	26.5	1.14
N	straight cable plug	29080PV	•	18	1.14
TNC	straight cable plug	29714PV	•	18	1.14

# SUCOFLEX® 329

## Assembly types

		SUCOFLEX 329
Construction		
Max. operating frequency	GHz	29
Application		static and dynamic
Velocity of propagation	%	82
Weight	g/m	40
Min. bending radius static	mm	23
Min. bending radius repeated	mm	70
Temperature range	°C	-65 to +165
Tensile load	N	133
Inner conductor		solid wire
Dielectric		PTFE microporous
Outer conductor		CuAg flat wire braid
Jacket		ECTFE
Outer diameter	mm	5.1
Screening effectiveness (up to 18 GHz)	dB	> 90
Phase stability vs. flexure (360°, diameter 125 mm)	°el/GHz	< 0.65
Phase stability vs. temperature (-55 to +85 °C)	ppm	< 800
Assembly phase matching tolerances	°el/GHz	± 0.5
Cable attenuation at 25 °C	dB/m	see graph
Insertion loss stability vs. bending	dB	± 0.2
Insertion loss stability vs. temperature	%/°C	< 0.2
Power handling	watt	see graph
Radiation-gamma	Mrad	200
Connectors vented		yes
Out gassing according ECSS-Q_ST-70-02 and NASA reference publication 1124		TML < 1 %, CVCM < 0.1 %
Soldering according to ESA qualified materials and processes		J-STD-001ES
Assembling in clean room		class 100 000

# SUCOFLEX<sup>®</sup> 329

Attenuation (nominal values at +25 °C ambient temperature)

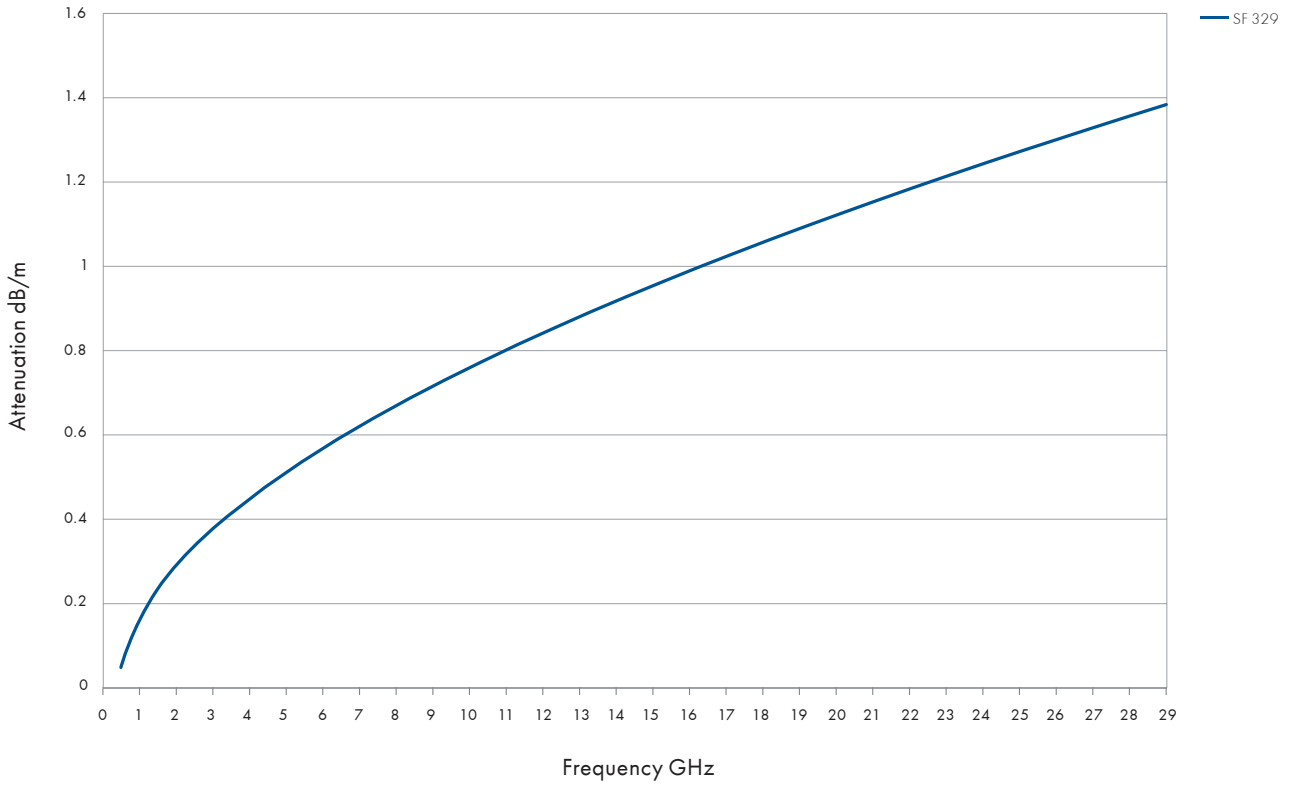

Power handling (maximum values at 25 °C ambient temperature and sea level)

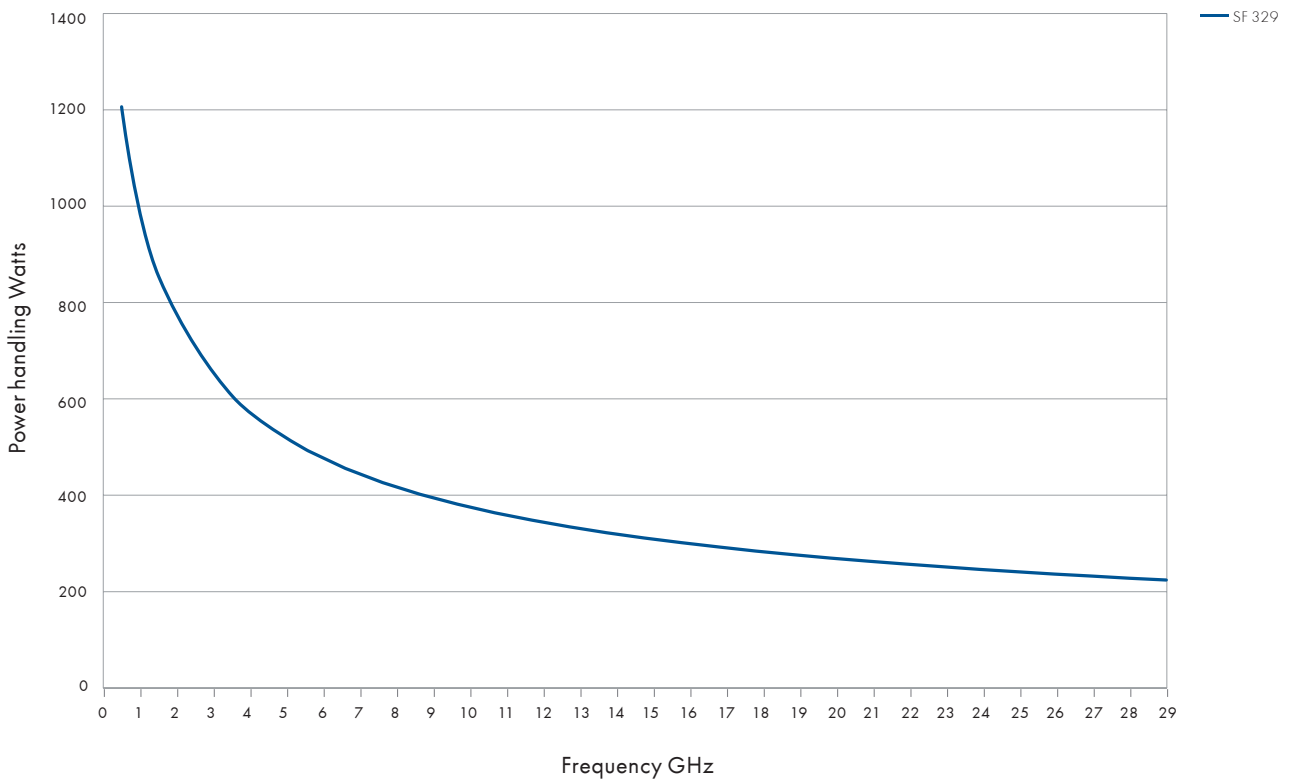



# SUCOFLEX® 340

Light weight, phase stable assembly for space and airborne applications

## Product description

The SUCOFLEX 340 offers a consistently outstanding mechanical and electrical performance, stability and reliability up to 40 GHz with triple shielding for improved screening attenuation. The added feature of this SUCOFLEX type is a weight reduction of up to 50 % compared to our conventional products.

## Product features

- Impedance 50 Ω
- Applicable up to 40 GHz
- Light weight
- MIL-DTL-17 qualified
- Low loss and high phase stability vs. temperature
- Outgassing free acc. ESA/NASA
- Standard and high radiation resistance version available



## Recommended connectors

SF340	SMA, SK
	Other connectors available on request

## Construction

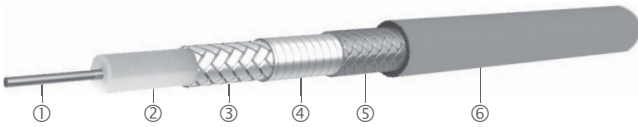

Cable	Inner conductor ①	Dielectric ②	Outer conductor ③	Barrier ④	Outer braid ⑤	Jacket ⑥	Outer diameter
SUCOFLEX_340	AlCuAg wire	PTFE microporous	CuAg flat wire braid	aluminium/ polyimide tape	AlCuAg	ECTFE, black	mm 4.2

## Available connectors

Connector	Series, pattern	HUBER+SUHNER connector type	SF340	Operating frequency	VSWR per connector
				GHz	
SK	straight cable plug	29094KPV	•	40	1.14
SMA	straight cable plug	29094PV	•	26.5	1.14

# SUCOFLEX® 340

## Assembly types

		SUCOFLEX 340
Construction		
Max. operating frequency	GHz	40
Application		static and dynamic
Velocity of propagation	%	82
Weight	g/m	27
Min. bending radius static	mm	8.4
Min. bending radius repeated	mm	25
Temperature range	°C	-65 to +165
Tensile load	N	133
Inner conductor		solid wire
Dielectric		PTFE microporous
Outer conductor		flat wire braid
Jacket		ECTFE
Outer diameter	mm	4.2
Screening effectiveness (up to 18 GHz)	dB	> 90
Phase stability vs. flexure (360°, diameter 125 mm)	°el/GHz	< 0.65
Phase stability vs. temperature (-55 to +85 °C)	ppm	< 800
Assembly phase matching tolerances	°el/GHz	± 0.5
Cable attenuation at 25 °C	dB/m	see graph
Insertion loss stability vs. bending	dB	± 0.2
Insertion loss stability vs. temperature	%/°C	< 0.2
Power handling	watt	see graph
Radiation-gamma	Mrad	200
Connectors vented		yes
Out gassing according ECSS-Q_ST-70-02 and NASA reference publication 1124		TML < 1 %, CVCM < 0.1 %
Soldering according to ESA qualified materials and processes		J-STD-001ES
Assembling in clean room		class 100 000

# SUCOFLEX® 340

High performance

Attenuation (nominal values at +25 °C ambient temperature)

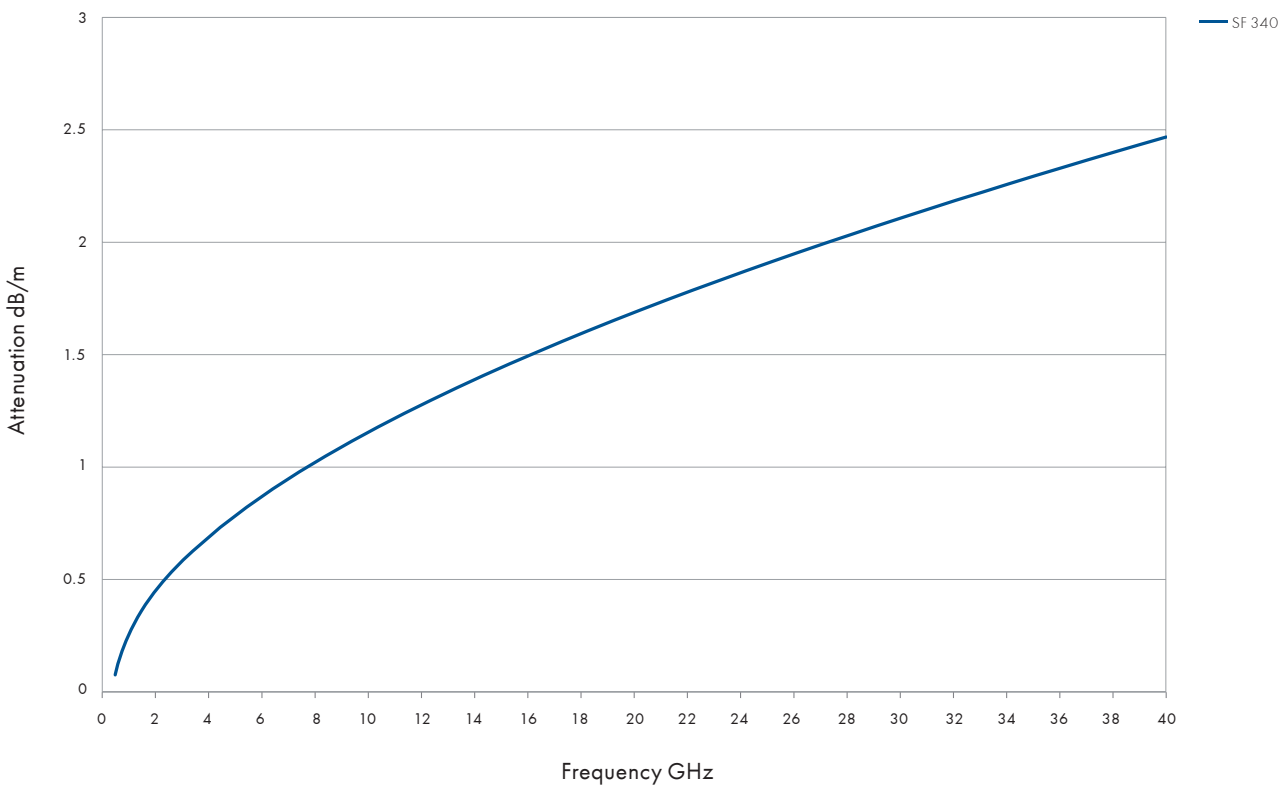

Power handling (maximum values at 25 °C ambient temperature and sea level)

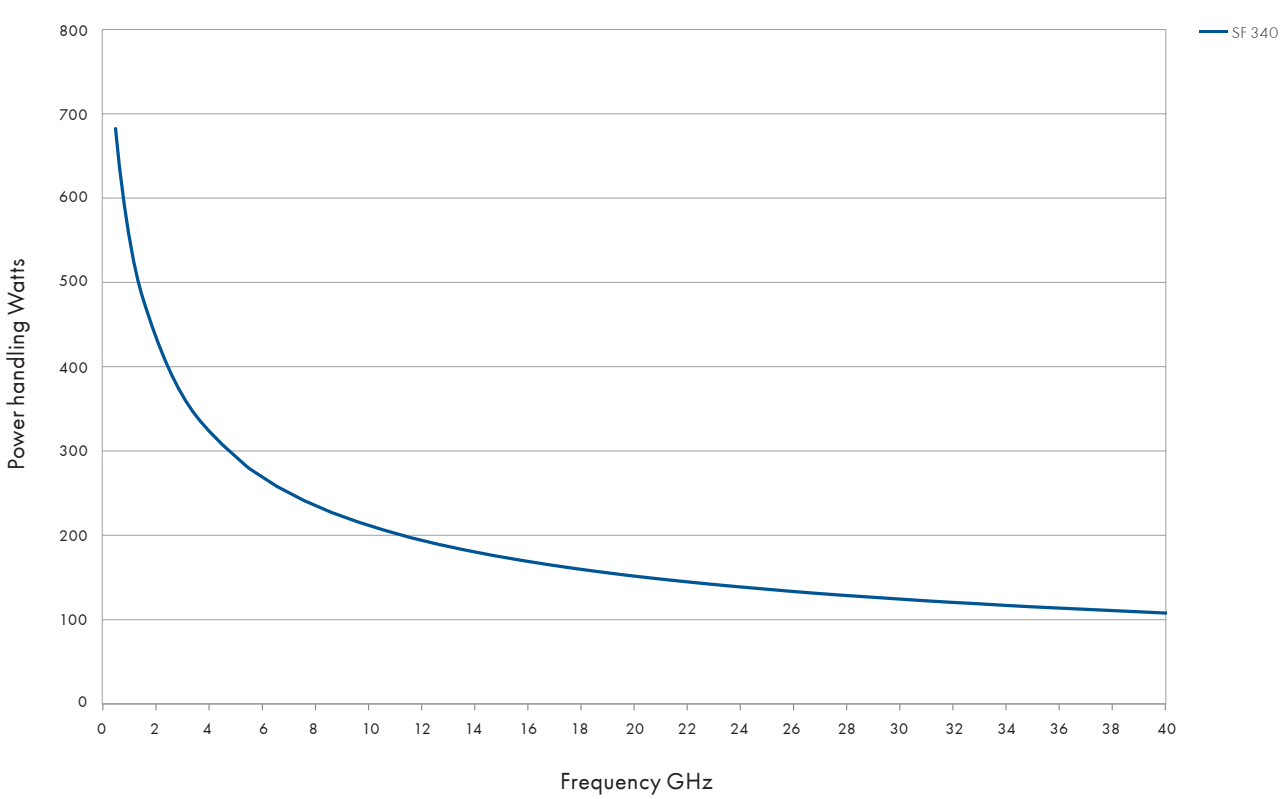

# Overview SUCOFLEX® 400

The low loss benchmark

## Product description

The SUCOFLEX 400 microwave assembly family has been specifically developed for static high performance defense, applications, and anywhere the best insertion loss, high phase stability versus temperature, excellent return loss are of the utmost importance.

Today's advanced radio frequency systems enable critical applications in defense and must comply with the highest demands. So it is essential that the interconnection components rely on the highest standards as well. The SUCOFLEX 400 family meets these challenges and gives you the opportunity to design with the highest performance microwave cable in its class.



## Product features

- Best insertion loss on the market
- High phase stability versus temperature
- Excellent voltage standing wave ratio (VSWR)
- Can be provided with various ruggedisations to protect the assembly against different environmental influences
- Available as assembly only
- For static applications only

## Recommended connectors

SF404	SMA, BMA, N, TNCA, PC3.5
	Other connectors available on request

## Technical data

HUBER+SUHNER cable type	Operating frequency	Temperature range	Outer diameter	Nominal attenuation 18 GHz, 25 °C	Bending radii		Weight	More information see page
	GHz				°C	mm		
SUCOFLEX_404	26.5	-55 to +125	5.5	0.99	static 25	repeated 35	72	67
SUCOFLEX_404_D	26.5	-55 to +125	6.1	0.99	30	40	82	67
SUCOFLEX_404_A	26.5	-40 to +85	10.3	0.99	30	50	162	67
SUCOFLEX_406_D	18	-55 to +125	8.8	0.64	40	80	155	70
SUCOFLEX_406_A	18	-40 to +85	13.20	0.64	50	90	203	70

# SUCOFLEX® 404

The low loss benchmark up to 26.5 GHz

## Product description

SUCOFLEX 404 is ideal for static applications up to 26.5 GHz or wherever the loss over frequency is a critical factor. With the existing connectors PC3.5, SMA, N and TNCA we cover various applications and sectors of industry.

## Product features

- Impedance 50 Ω
- Applicable up to 26.5 GHz
- Best insertion loss on the market
- High phase stability versus temperature
- Excellent voltage standing wave ratio (VSWR)



High performance

## Construction

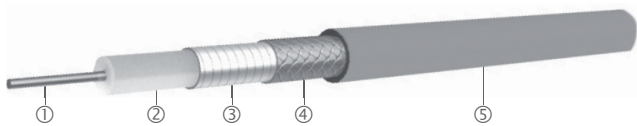

SF 404

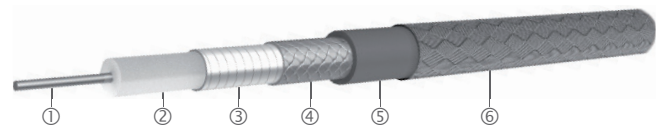

SF 404\_D

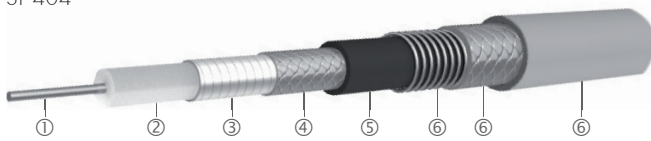

SF 404\_A

## Recommended connectors

SF404	SMA, TNCA, N, PC3.5
	Other connectors available on request

Cable	Inner conductor ①	Dielectric ②	Outer conductor ③ ④	Jacket ⑤	Ruggedisation ⑥	Outer diameter mm
SUCOFLEX_404	CuAg wire	ULD-PTFE	CuAg tape/braid	FEP, brown	no	5.5
SUCOFLEX_404_D	CuAg wire	ULD-PTFE	CuAg tape/braid	FEP	aramid yarn braid, black	6.1
SUCOFLEX_404_A	CuAg wire	ULD-PTFE	CuAg tape/braid	FEP	stainless steel/PUR, black	10.3



Other SUCOFLEX 404 cables available on request.

## Available connectors

Connector	Series, pattern	HUBER+SUHNER connector type	SF404	SF404D	SF404A	Operating frequency GHz	VSWR per connector	Remarks
N	straight cable plug	11_N-431	•	•	•	18	1.12	
PC 3.5	straight cable plug	11_PC35-407	•	•	•	18 26.5	1.11 1.14	
	straight cable plug	11_PC35-410	•	•	•	18 26.5	1.11 1.14	QL
	straight cable jack	21_PC35-407	•	•	•	18 26.5	1.11 1.14	
SMA	straight cable plug	11_SMA-401	•	•	•	18	1.15	
TNCA	straight cable plug	11_TNCA-401	•	•	•	18	1.16	

# SUCOFLEX® 404

## Assembly types

		SUCOFLEX 404	SUCOFLEX 404D	SUCOFLEX 404A
Construction				
Max. operating frequency	GHz	26.5	26.5	26.5
Application		static	static	static
Velocity of propagation	%	89	89	89
Weight	g/m	72	82	162
Min. bending radius static	mm	25	30	30
Min. bending radius repeated	mm	35	40	50
Temperature range	°C	-55 to +125	-55 to +125	-40 to +85
Crush resistance	kN/m	2	5	80
Tensile load	N	115	115	500
Inner conductor		solid wire	solid wire	solid wire
Dielectric		ULD-PTFE	ULD-PTFE	ULD-PTFE
Outer conductor		tape/braid	tape/braid	tape/braid
Jacket		FEP	FEP	FEP
Ruggedisation		no	aramid yarn braid	stainless steel/PUR
Outer diameter	mm	5.5	6.1	10.3
Screening effectiveness (up to 18 GHz)	dB	> 90	> 90	> 90
Phase stability vs. flexure (360°, diameter 55 mm)	°el/GHz	< 1.7	< 1.7	< 1.7
Phase stability vs. temperature (-40 to +85 °C)	ppm	< 500	< 500	< 500
Assembly phase matching tolerances	°el/GHz	± 0.5	± 0.5	± 0.5
Cable attenuation at 25 °C	dB/m	see graph	see graph	see graph
Insertion loss stability vs. bending	dB	± 0.1	± 0.1	± 0.1
Insertion loss stability vs. temperature	%/°C	< 0.26	< 0.26	< 0.26
Insertion loss stability vs. shaking	dB	± 0.2	± 0.2	± 0.2
Power handling	watt	see graph	see graph	see graph

# SUCOFLEX<sup>®</sup> 404

High performance

Attenuation (nominal values at +25 °C ambient temperature)

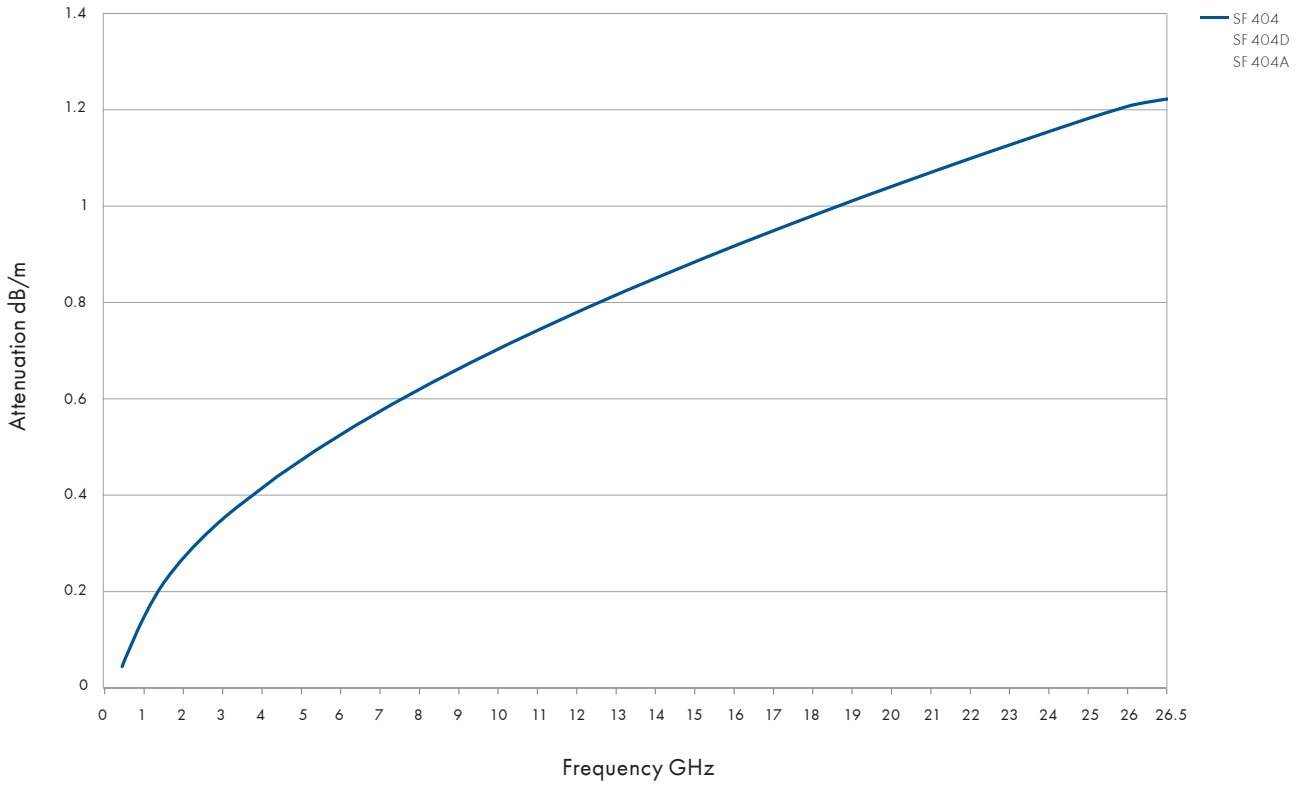

Power handling (maximum values at 25 °C ambient temperature and sea level)

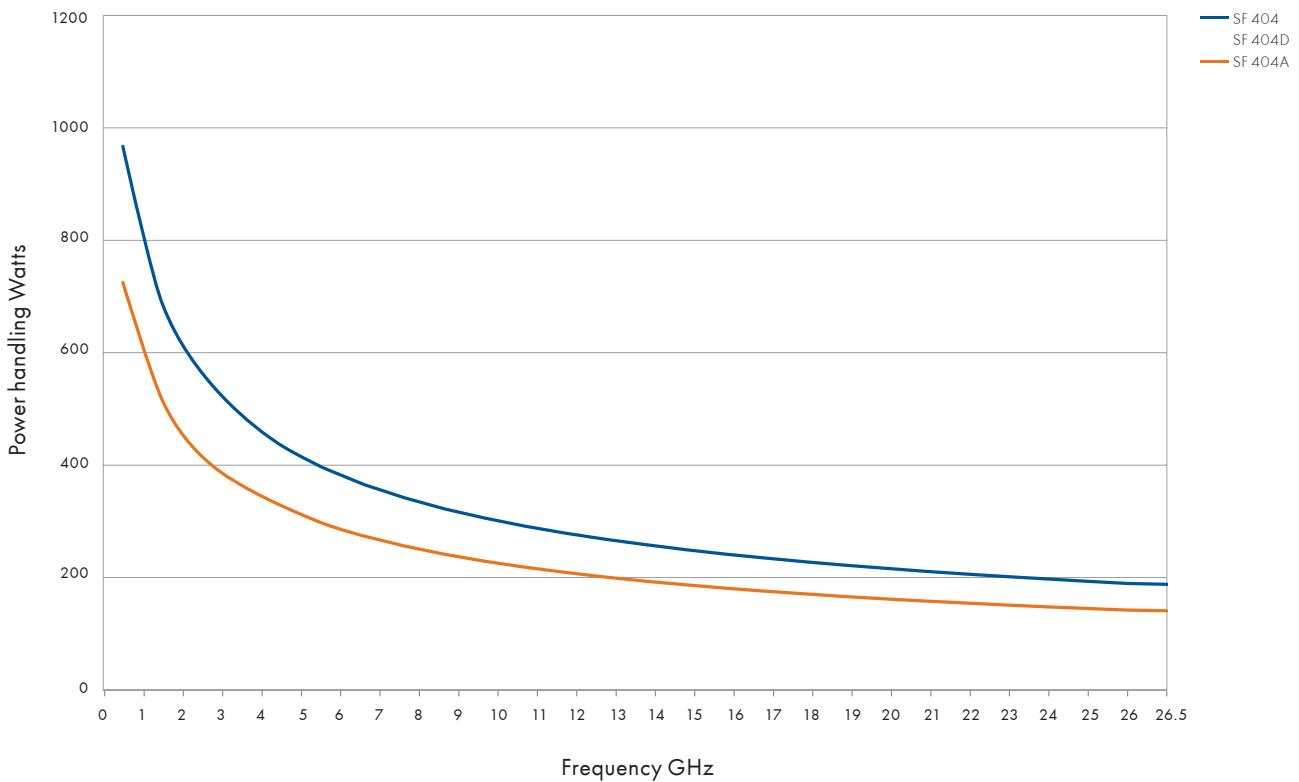





# SUCOFLEX® 500



When it comes to test and measurement, SUCOFLEX 500 assemblies guarantee the highest level of satisfaction

- Torque, crush and kink resistant
- Precise and repeatable measurements
- Long service life
- Reduce total cost of test with durable, reliable performance
- Increased test and measurement efficiency saving costs due to reduced calibration intervals

# Overview SUCOFLEX® 526

Plug, test, smile

## Product description

When it comes to test and measurement, SUCOFLEX® 526V and SUCOFLEX® 526S assemblies guarantee the highest level of satisfaction. Thanks to their unique cable and connector design, they deliver best-in-class phase and amplitude stability vs. flexure, movement, temperature and tensile stress in combination with outstanding return and insertion loss up to 26.5 GHz.



# Sucoflex 526 product comparison



	Sucoflex_526V	Sucoflex_526S
Applications	Vector network analysers (VNAs) Critical laboratory conditions	Bench top testing, RF production testing, Automated test equipment
Features and benefits	Best-in-class phase and amplitude stability vs. flexure, movement, temperature and tensile stress  Excellent return loss  Extremely flexible and ease of handling	Excellent return- and insertion loss  Phase and amplitude stability vs. flexure and movement  Abrasion, moisture and dust resistance
	Torque, crush and kink resistant Robust and precise center positioning of 3.5 mm center conductors  Precise and repeatable measurements  Long service life  Reduce total cost of test with durable, reliable performance  Increased test and measurement efficiency saving costs due to reduced calibration intervals	
Diameter	13 mm	7.7 mm
Min. bending radius	50 mm	25.4 mm
Available connectors	PC 3.5	PC 3.5, SMA, N
Crush resistance	80 kN/m	26 kN/m
Typ. flex cycles	100.000 2.0 Mio. for slight movements	100.000
Operating temperature	laboratory conditions, analyzer specific (+15 to +30 °C)	-55 to +125°C
RoHS, REACH	Compliant	Compliant
Operating frequency	up to 26.5 GHz	up to 26.5 GHz
Velocity of propagation	80 %	77 %
Return loss	typ. 25 dB min. 20 dB	typ. 25.0 dB min. 19 dB
Insertion loss (25 / 38 / 48 in) @ 26.5 GHz	max. 2.5 / 3.6 / 4.4 dB	typ. 1.63 dB/m incl. connectors max 1.77 dB/m incl. connectors
Screening effectiveness	> 90 dB	> 90 dB
Amplitude stab. vs. movement	max. 0.05 dB	typ. ± 0.05 dB
Amplitude stab. vs. flexure	max. 0.08 dB	typ. ± 0.05 dB
Phase stability vs. flexure (25 / 38 / 48 in)	max. 3.9 / 7.4 / 10°	typ. ± 3.0°
Phase stab. vs. tensile stress	max. 0.1°/GHz 100 N up to 26.5 GHz	N/A
Phase stab. vs. temperature	typ. 50 ppm +15 °C to +30 °C, 26.5 GHz	typ. 1500 ppm -55°C to + 125°C
Phase matched assemblies available	No	Yes, upon request
New optimised PC3.5 interface supports S-parameter measurements with the highest accuracy	Yes	Yes
Stock assemblies available	Yes	Yes

# SUCOFLEX® 526V



The only VNA microwave cable worldwide with a typical 50 ppm phase variation vs. temperature between +15 and +30 °C. No "PTFE phase knee" at +19 °C as seen on conventional VNA test cable assemblies which cause phase variations and unstable measurements in critical laboratory conditions.

## Available connectors

Product configuration	85069744	85081169	85070046	85081172	85070047	85081177
Cable type	SUCOFLEX 526V					
Length	25" (635 mm)	25" (635 mm)	38" (965 mm)	38" (695 mm)	48" (1219 mm)	48" (1219 mm)
Connector A	3.5 mm ruggedised PORT female (35VF)					
Connector B	3.5 mm ruggedised DUT male (35VM)	3.5 mm DUT female (35F)	3.5 mm ruggedised DUT male (35VM)	3.5 mm DUT female (35F)	3.5 mm ruggedised DUT male (35VM)	3.5 mm DUT female (35F)
<b>Mechanical data</b>						
Diameter	13 mm					
Min. bending	50 mm					
Crush resistance	80 kN/m					
Flex life	100 000 cycles 2.0 Mio. for slight movements					
<b>Environmental data</b>						
Operating temperature	laboratory conditions, analyser specific (+15 to +30 °C)					
RoHS, REACH	compliant					
<b>Electrical data</b>						
Impedance	50 Ω					
Operating frequency	up to 26.5 GHz					
Velocity of propagation	80 %					
Time delay	4.15 ns/m					
Return loss	typ. 25 dB min. 20 dB					
Insertion loss	max. 2.5 dB		max. 3.6 dB		max. 4.4 dB	
Screening effectiveness	> 90 dB					
Amplitude stability vs. movement	max. 0.05 dB					
Amplitude stability vs. flexure	max. 0.08 dB					
Phase stability vs. flexure	max. 3.9°		max. 7.4°		max. 10°	
Phase stability vs. tensile stress	max. 0.1°/GHz (100 N)					
Phase stability vs. temperature	typ. 50 ppm (+15 to +30 °C)					

## Ordering information

Item no.	Description
85069744	SF526V/35VF/35VM/25in
85081169	SF526V/35VF/35F/25in
85070046	SF526V/35VF/35VM/38in
85081172	SF526V/35VF/35F/38in
85070047	SF526V/35VF/35VM/48in
85081177	SF526V/35VF/35F/48in

# SUCOFLEX<sup>®</sup> 526V

High performance

Phase shift vs. temperature (+15°C to +30°C)

		SUCOFLEX 526V	Conventional VNA test lead
Assembly length (in (mm))	Frequency (GHz)*	Phase shift /° (for 50 ppm, 80% VOP)	Phase shift /° (for 700 ppm, 84% VOP)
25 (635)	18	0.9	11.4
25 (635)	26.5	1.3	16.7

\*Other frequencies on request

Phase stability vs. temperature performance

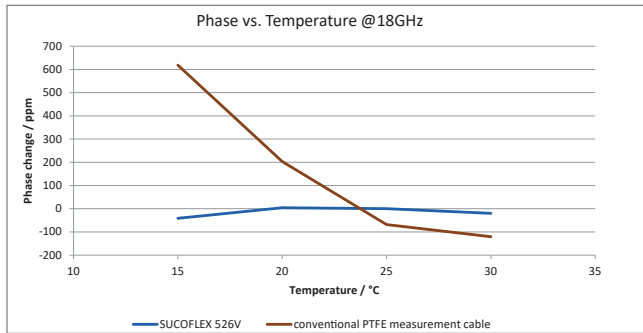

Phase stability vs. flexure

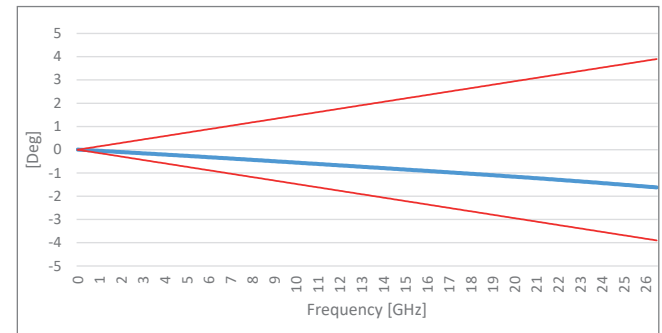

Insertion Loss

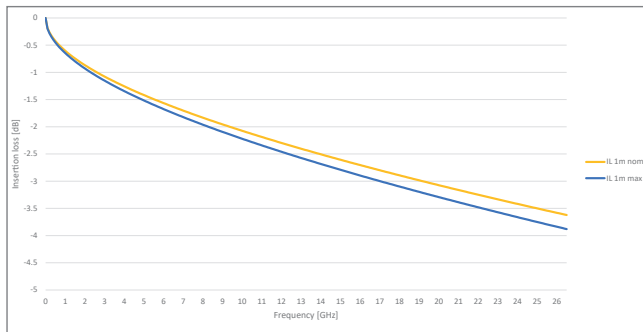

Loss stability vs. flexure

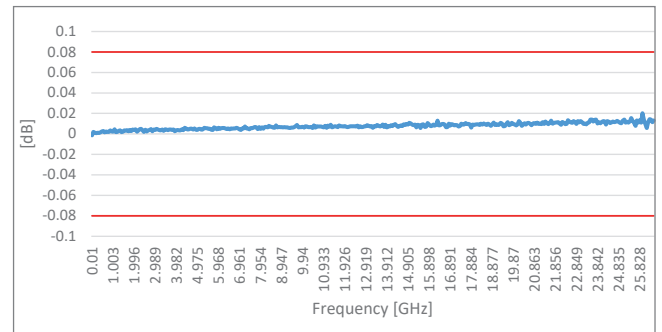

Return Loss SUCOFLEX 526V with two straight PC3.5 connectors

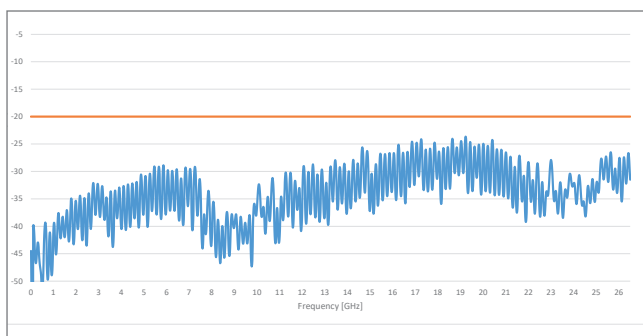

# Connector configuration

35 VF (3.5 mm ruggedized PORT female)

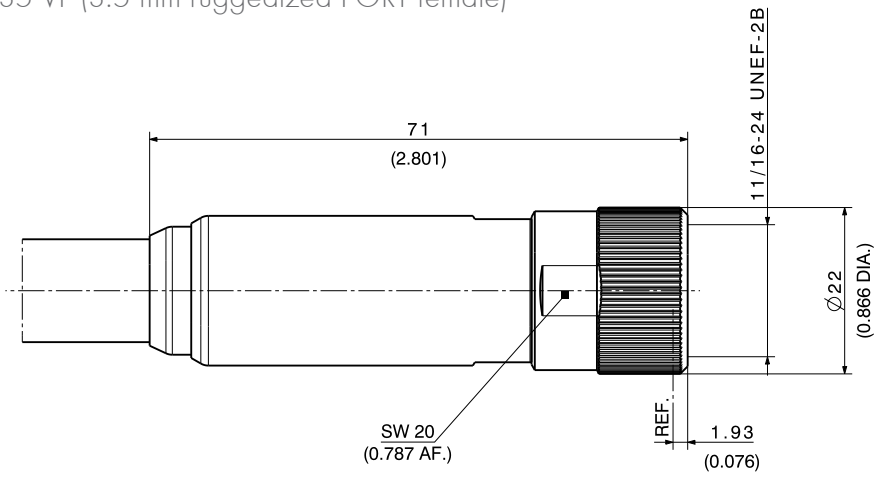

35 VM (3.5 mm ruggedized DUT male)

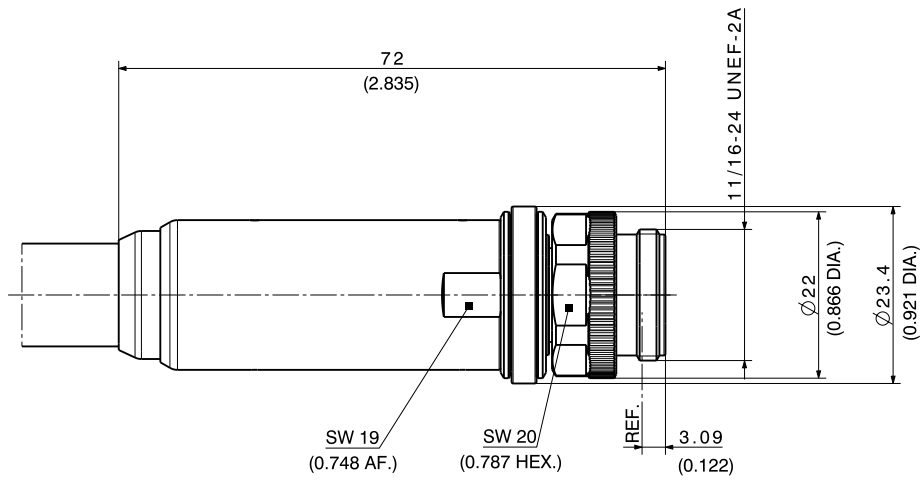

35 F (3.5 mm DUT female)

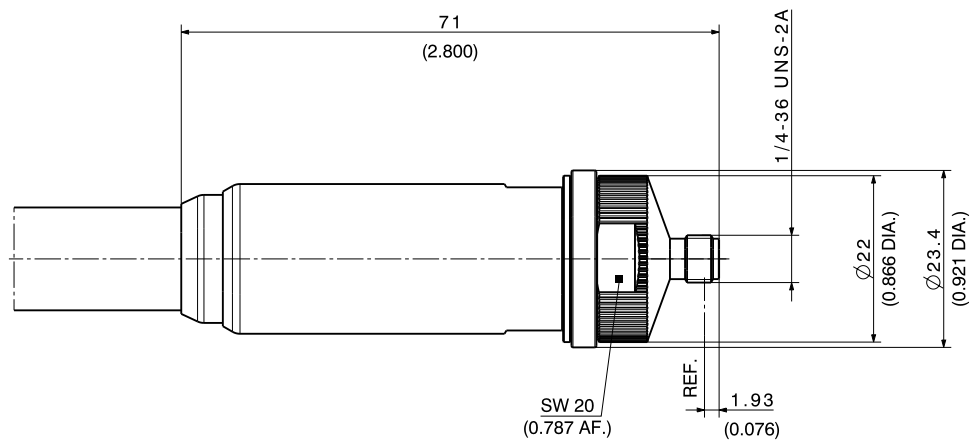

# SUCOFLEX® 526S



The SUCOFLEX 526S is the top performance cable assembly for various applications in test laboratories. When it comes to test and measurement, SUCOFLEX 526S assemblies guarantee the highest level of satisfaction. Thanks to their unique cable and connector design, they deliver best-in-class phase and amplitude stability vs. flexure in combination with outstanding return and insertion loss up to 26.5 GHz.

High performance

## Cable Construction

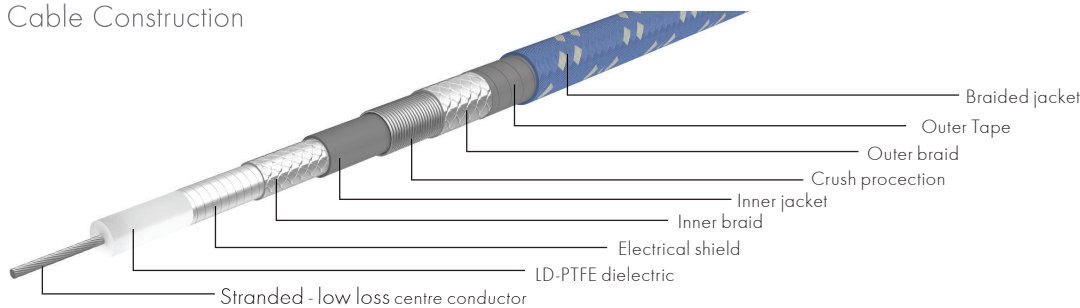

Mechanical data	
Diameter	7.7 mm
Min. bending	25.4 mm
Crush resistance	26 kN/m
Flex life	100 000 cycles
Environmental data	
Operating temperature	-55 to +125°C
RoHS, REACH	compliant
Electrical data	
Impedance	50 Ω
Operating frequency	up to 26.5 GHz
Velocity of propagation	77 %
Time delay	4.32 ns/m
Return loss	typ. 25 dB, min. 19 dB
Insertion loss	typ. 1.63 dB/m incl. connectors, max 1.77 dB/m incl. connectors
Screening effectiveness	> 90 dB
Amplitude stability vs. movement	typ. ± 0.05 dB
Amplitude stability vs. flexure	typ. ± 0.05 dB
Phase stability vs. flexure	typ. ± 3°
Phase stability vs. temperature	typically 1500 ppm (-55 to +125 °C)

## Ordering information

Item no.	Stock assembly type	
85090623	SF526S/11PC35/11PC35/500mm	PC3.5 male / PC3.5 male
85088164	SF526S/11PC35/11PC35/36inch	PC3.5 male / PC3.5 male
85090624	SF526S/11PC35/11PC35/1000mm	PC3.5 male / PC3.5 male
85092087	SF526S/11PC35/11PC35/1500mm	PC3.5 male / PC3.5 male
85090625	SF526S/11PC35/11PC35/2000mm	PC3.5 male / PC3.5 male
85090626	SF526S/11PC35/11PC35/3000mm	PC3.5 male / PC3.5 male
85093097	SF526S/11PC35/21PC35/500mm	PC3.5male / PC3.5 female
85090629	SF526S/11PC35/21PC35/36inch	PC3.5male / PC3.5 female
85093184	SF526S/11PC35/21PC35/1000mm	PC3.5male / PC3.5 female
85091104	SF526S/11PC35/21PC35/48inch	PC3.5male / PC3.5 female
85089172	SF526S/11N/11N/1000mm	N male / N male
85089173	SF526S/11SMA/11SMA/1000mm	SMA male / SMA male

# Connector configuration

11 PC 3.5

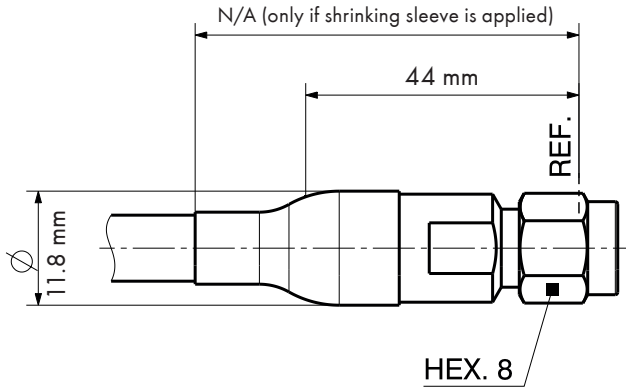

21 PC 3.5

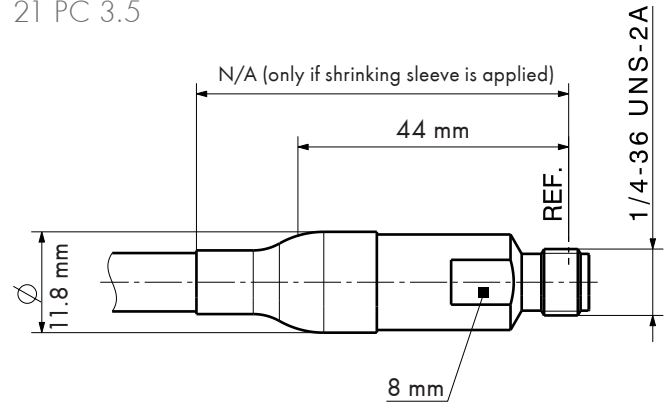

11 N

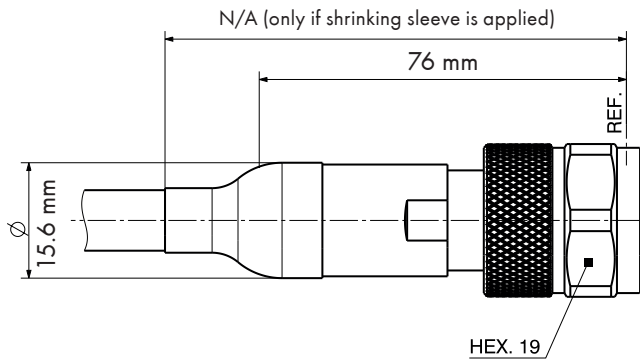

21 N

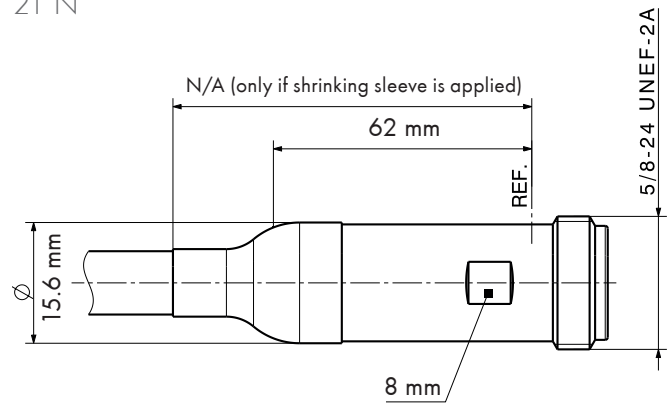

11 SMA

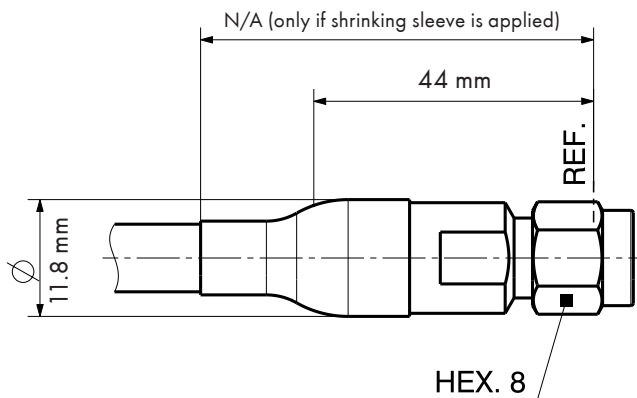



# SUCOFLEX® 526S

High performance

## Available connectors

Connector	Series, pattern	HUBER+SUHNER connector type	Temperature range	Operating frequency (GHz)
PC 3.5	Straight cable plug	11_PC-3.5	-55°C to +125°C	26.5
	Straight cable jack	21_PC-3.5		
N	Straight cable plug	11_N	-55°C to +75°C	18
	Straight cable jack	21_N		
SMA	Straight cable plug	11_SMA	-55°C to +125°C	18

## Phase vs. stability vs. flexure

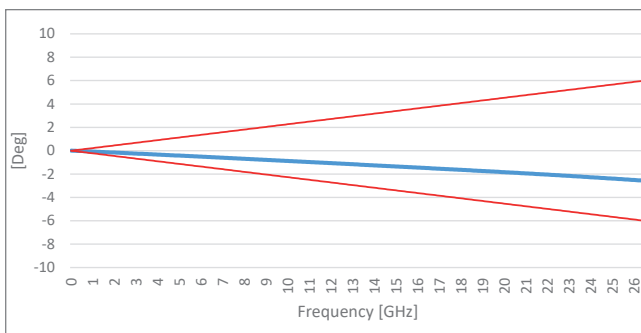

## Loss stability vs. flexure

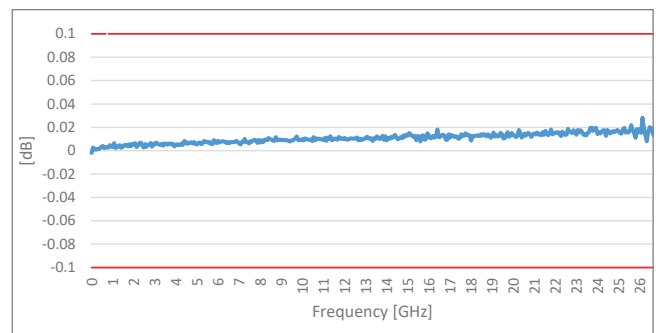

## Insertion Loss

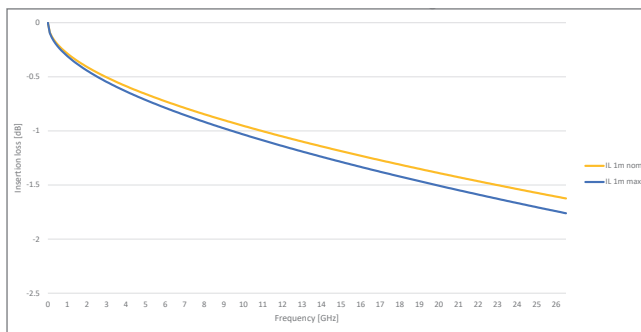

## Return Loss SUCOFLEX 526S with two straight PC3.5 connectors

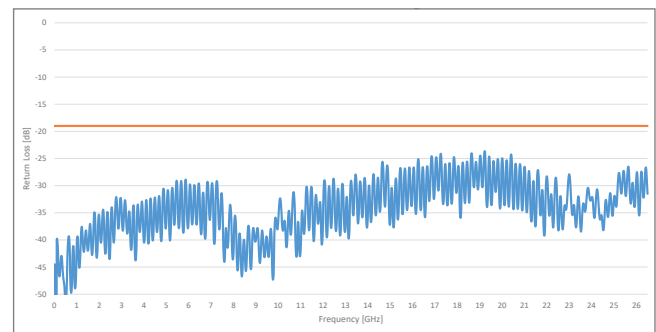

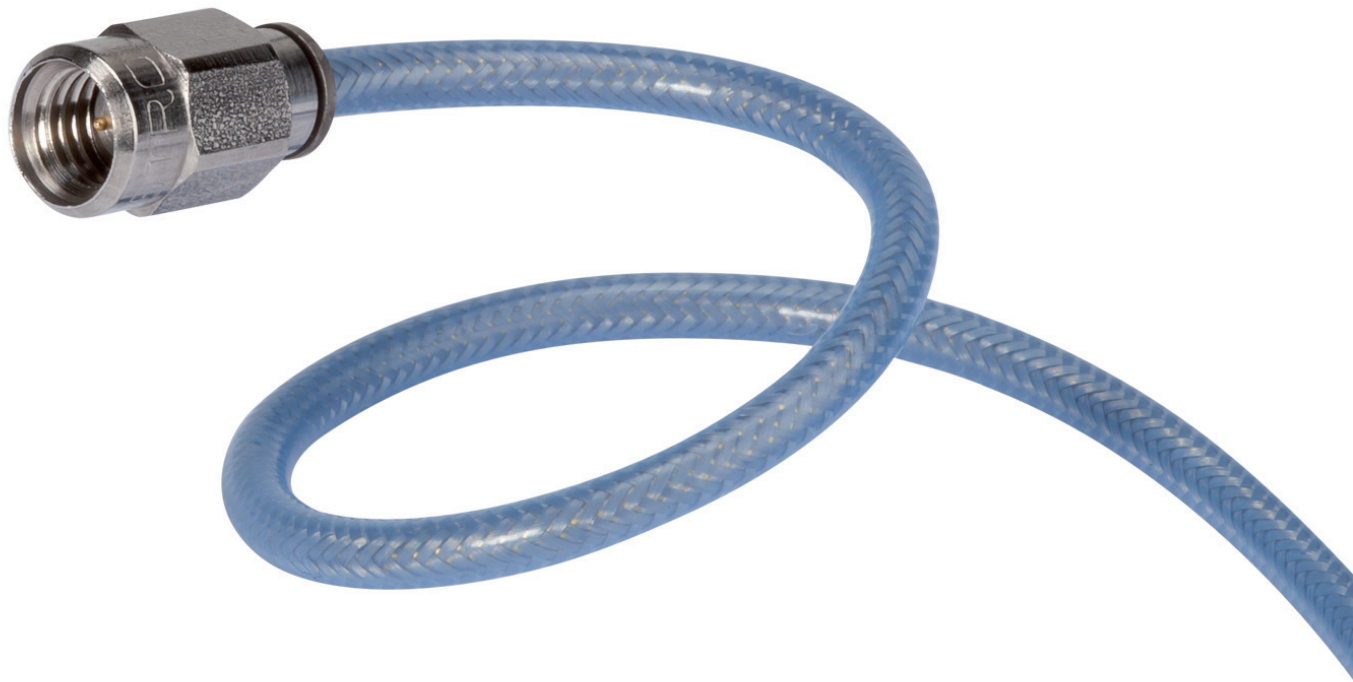

## Qualified, low profile microwave cable assemblies

Minibend is a truly flexible coaxial cable assembly which is designed for use in low profile, internal, point-to-point interconnections between RF modules within communications systems. Minibend replaces custom semi-rigid cables with standard flexible cables, eliminating the need for pre-defined custom lengths and bend configurations. Minibend provides you with a preassembled and tested high performance, cost-effective alternative in a variety of standard lengths and connector configurations.

Minibend R is designed for use in complex, congested environments where higher cable retention force is required. Minibend R's pull strength is more than 70 % greater than a standard Minibend. When installed and bent at the minimum bend radius, Minibend R will tolerate multiple 90° rotations at the cable/connector junction. The "R" ruggedisation can be added to any Minibend connector style. All materials used in Minibend R assemblies meet or exceed NASA TML and CVCM requirements for use in spacecraft applications.

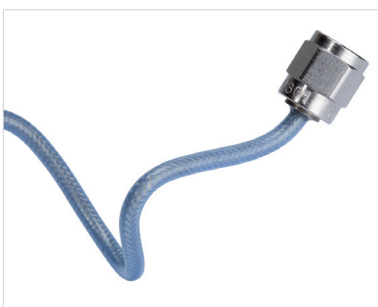

### Minibend

page 88

Low profile, high performance microwave coaxial cable assemblies

- Frequency range up to 65 GHz
- Triple shielded for high isolation
- Eliminates need for costly right angle connectors
- Direct replacement for 0.086 inch semi-rigid cables



### Minibend L

page 96

Low profile, high performance low loss microwave coaxial cable assemblies

- Frequency range up to 50 GHz
- Triple shielded for high isolation
- Microporous dielectric for 30 % lower insertion
- Direct replacement for 0.086 inch semi-rigid cables



### Microbend

page 100

Ultra low profile, high performance, microwave coaxial cable assemblies

- Frequency range up to 90 GHz
- Triple shielded for high isolation
- Direct replacement for 0.047 inch semi-rigid cables
- Guaranteed 10 lbs (45 N) pull force



### Mini141

page 109

Low profile, high performance ultra low loss microwave cable assemblies

- Frequency range up to 40 GHz
- Triple shielded for high isolation
- Eliminates need for costly right angle connectors
- Direct replacement for 0.141 inch semi-rigid cables

# Minibend

High performance/high pull strength microwave coaxial cable assembly

## Product description

Minibend is a truly flexible coaxial cable assembly which is designed for use in low profile, internal, point-to-point interconnections between RF modules within communications systems. Minibend replaces 0.086 inch custom semi-rigid cables with standard flexible cables, eliminating the need for predefined custom lengths and bend configurations. Minibend provides you with a preassembled and tested high performance, cost-effective alternative in a variety of standard lengths and connector configurations.

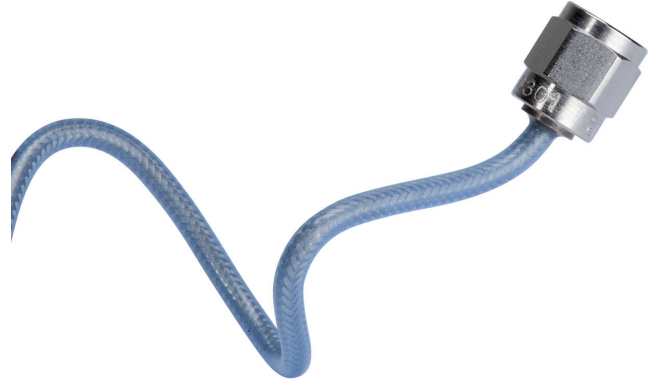

## Product features

- Impedance 50 Ω
- Applicable up to 65 GHz
- Direct replacement for 0.086 inch semi-rigid cables
- Stock delivery on standard lengths

## Recommended connectors

Minibend	SMA, SSMA, SK, SMP, 2.4 mm, 1.85 mm
	Other connectors available on request

## Construction

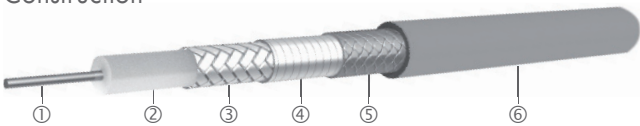

Cable	Inner conductor ①	Dielectric ②	Outer conductor ③	Barrier ④	Outer braid ⑤	Jacket ⑥	Outer diameter mm
32081	CuAg wire	PTFE	CuAg flat wire braid	aluminium/ polyimide tape	stainless steel	FEP	2.5
32081S	StCuAg wire	PTFE	CuAg flat wire braid	aluminium/ polyimide tape	stainless steel	FEP	2.5

## Technical data

Cable	Operating frequency GHz	Velocity %	Weight g/m	Min. bending radius for ± 180° mm	Temperature range ° C
32081/32081S	65	70.3	14.9	5.08	-55 to +200

Assembly	Minibend	Minibend A	Minibend E	Minibend K	Minibend KS	Minibend KV	Minibend QG
Connector A	SMA (m)	SSMA (m)	SMA (m), fully captivated	SK (m)	SK (m)	2.4 mm (m)/ 1.85 mm (m)	2.4 mm (m) gold plated BeCu
Connector B	SMA (m)	SSMA (m)	SMA (m), fully captivated	SK (m)	SMP (f)	SK (m)	2.4 mm (m) gold plated BeCu

Assembly	Minibend S	Minibend 2S	Minibend V	Minibend VG	Minibend WR
Connector A	SMA (m)	SMP (f)	2.4 mm/1.85 mm (m)	1.85 mm (m) gold plated BeCu	SMA (m)
Connector B	SMP (f)	SMP (f)	2.4 mm/1.85 mm (m)	1.85 mm (m) gold plated BeCu	SMA (m)

# Minibend

Attenuation (nominal values at +25 °C ambient temperature)

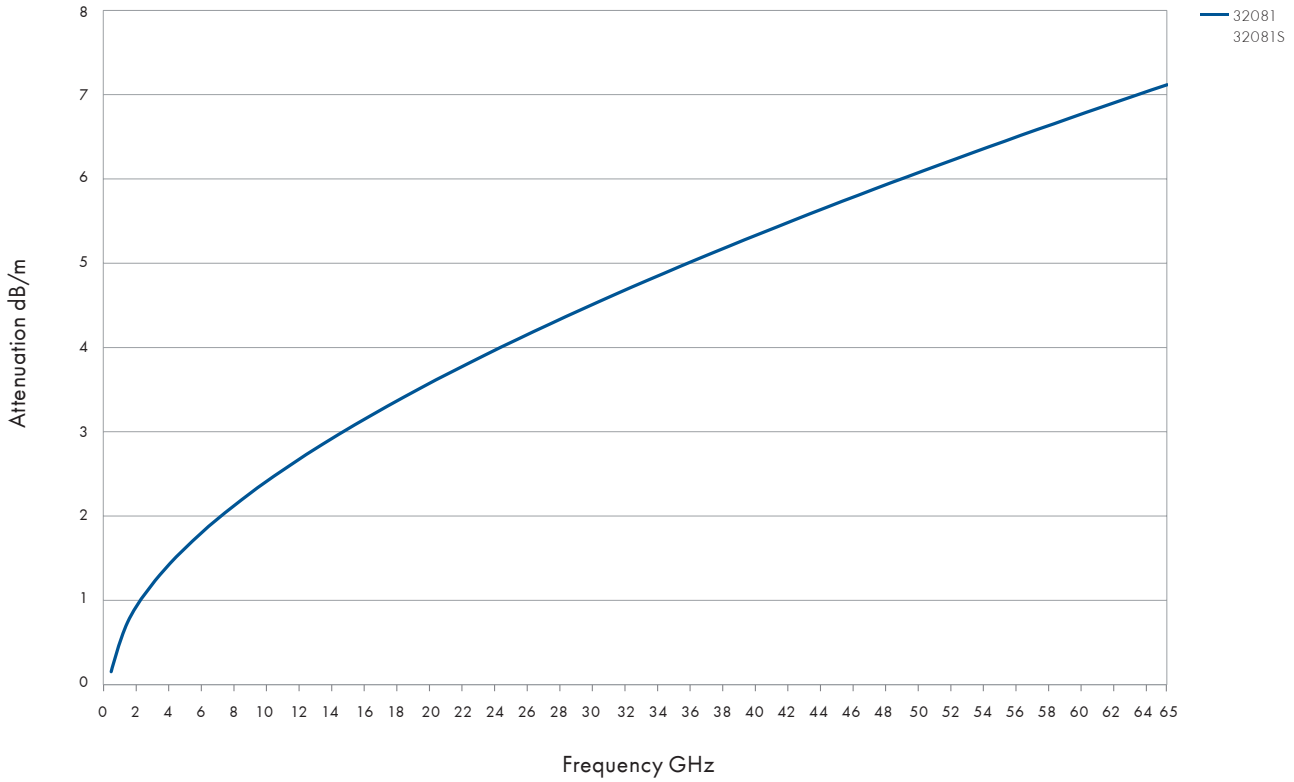

Power handling (maximum values at 25 °C ambient temperature and sea level)

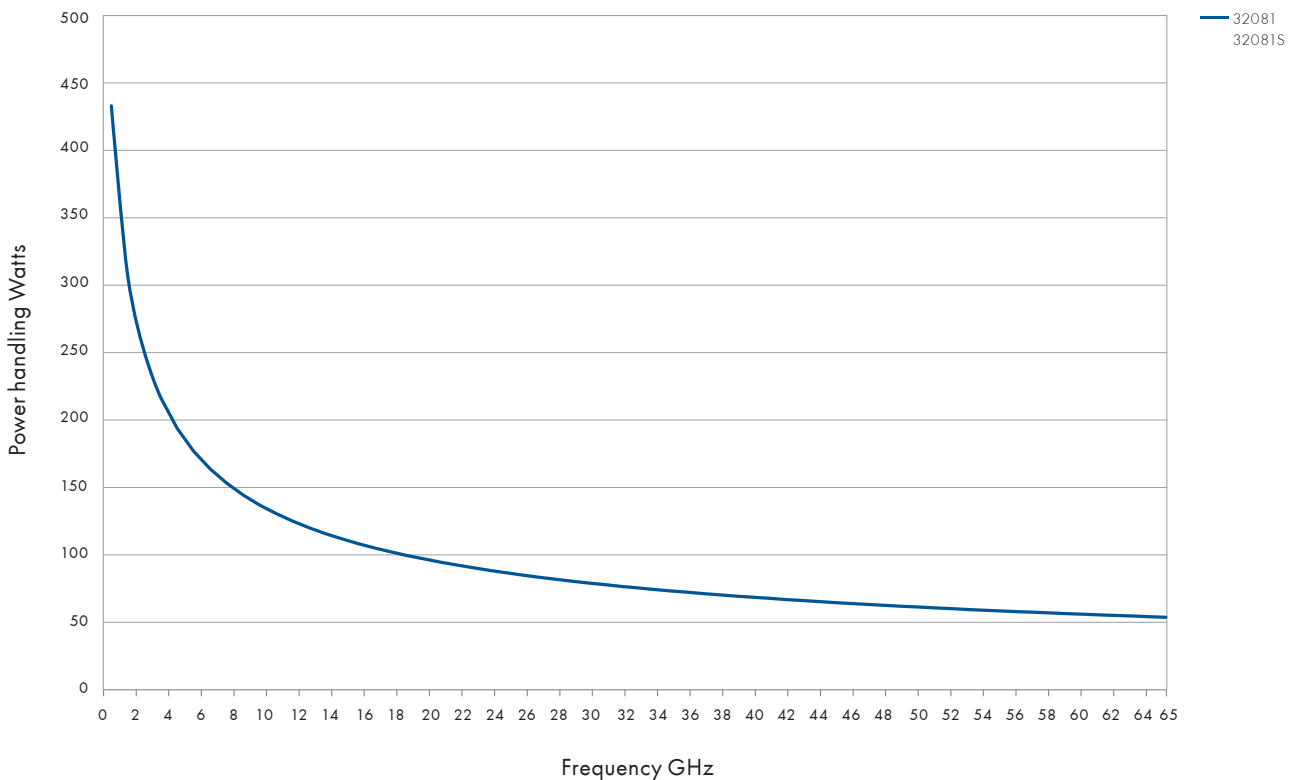

Low profile assemblies

# Minibend

Minibend is a flexible coaxial cable assembly which is designed for use in low profile, internal point-to-point interconnections between RF modules within communications systems. Minibend replaces 0.086 inch custom semi-rigid cables with standard flexible cables eliminating the need for predefined custom lengths and bend configurations. Minibend provides you with a preassembled and tested high performance, cost-effective alternative in a variety of standard lengths.

- Frequency range up to 24 GHz
- Precision stainless steel SMA plug connectors
- Ruggedised version available "R"



Length mm	Minibend	Item no.	Minibend R	Item no.
63.5	minibend-2.5	80337902	minibend R-2.5	80337536
76.2	minibend-3	80337926	minibend R-3	80337569
88.9	minibend-3.5	80337929	minibend R-3.5	80337570
101.6	minibend-4	80337942	minibend R-4	80337585
114.3	minibend-4.5	80337947	minibend R-4.5	80337587
127	minibend-5	80337959	minibend R-5	80337606
139.7	minibend-5.5	80337960	minibend R-5.5	80337607
152.4	minibend-6	80337969	minibend R-6	80337616
165.1	minibend-6.5	80337972	minibend R-6.5	80337617
177.8	minibend-7	80337981	minibend R-7	80337625
203.2	minibend-8	80337990	minibend R-8	80337631
228.6	minibend-9	80337999	minibend R-9	80337637
254	minibend-10	80337853	minibend R-10	80337509
279.4	minibend-11	80337859	minibend R-11	80337512
304.8	minibend-12	80337864	minibend R-12	80337515
330.2	minibend-13	80337873	minibend R-13	80337520
355.6	minibend-14	80337877	minibend R-14	80337522
381	minibend-15	80337881	minibend R-15	80337525
406.4	minibend-16	80337886	minibend R-16	80337526

# Minibend A

Minibend A has all the benefits of the original Minibend but with precision stainless steel SSMA connectors on each end. Minibend A is available in a standard 26.5 GHz max. frequency or an optional 40 GHz max. configuration. Minibend A flexible coaxial cable assemblies are cost-effective replacements for .086 inch semi-rigid cables in point-to-point interconnections between RF modules. Minibend A eliminates the need for custom pre-defined lengths and bend configurations.

- Frequency range up to 40 GHz
- Precision stainless steel SSMA plug connectors
- Ruggedised version available "R"



Length mm	Minibend A	Item no.
63.5	minibend A-2.5	80336959
76.2	minibend A-3	80336961
88.9	minibend A-3.5	80336963
101.6	minibend A-4	80336965
114.3	minibend A-4.5	80366167
127	minibend A-5	80336969
139.7	minibend A-5.5	80370925
152.4	minibend A-6	80336971
165.1	minibend A-6.5	80370926
177.8	minibend A-7	80336973
203.2	minibend A-8	80336974
228.6	minibend A-9	80365469
254	minibend A-10	80336954
279.4	minibend A-11	80336955
304.8	minibend A-12	80336956
330.2	minibend A-13	80365470
355.6	minibend A-14	80336957
381	minibend A-15	80370927
406.4	minibend A-16	80336958

# Minibend E

Minibend E is a fully captivated (contact, dielectric and body), ruggedised version of the original Minibend that is suitable for use in spacecraft applications, severe environments and high density packages. The Minibend E contact will not shift more than 0.005 inch when subjected to 10 lbs push force (cabled) or 5 lbs push force uncabled. All materials used in Minibend E assemblies meet or exceed NASA TML and CVCM requirements for use in spacecraft applications.

- Frequency range up to 18 GHz
- Precision stainless steel SMA plug connectors
- Automatically ruggedised by design



Length mm	Minibend E	Item no.
63.5	minibend E-2.5	80369350
76.2	minibend E-3	80337037
88.9	minibend E-3.5	80337040
101.6	minibend E-4	80337046
114.3	minibend E-4.5	80337047
127	minibend E-5	80337051
139.7	minibend E-5.5	80337052
152.4	minibend E-6	80337056
165.1	minibend E-6.5	80337057
177.8	minibend E-7	80337061
203.2	minibend E-8	80337063
228.6	minibend E-9	80370929
254	minibend E-10	80337020
279.4	minibend E-11	80337023
304.8	minibend E-12	80337025
330.2	minibend E-13	80366191
355.6	minibend E-14	80337028
381	minibend E-15	80337030
406.4	minibend E-16	80363369

# Minibend K

Minibend K is a 40 GHz version of the Minibend flexible coaxial cable assembly which is designed for use in low profile, internal point-to-point interconnections between RF modules within communications systems. Minibend K replaces small custom semi-rigid cables with standard flexible cables, eliminating the need for predefined custom lengths and bend configurations. Minibend K provides you with a preassembled and tested high performance, cost-effective alternative in a variety of standard lengths.

- Frequency range up to 40 GHz
- Precision SK Minibend plug connectors
- Ruggedised version available "R"

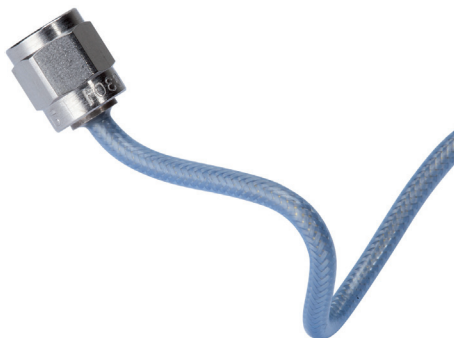

Length mm	Minibend K	Item no.	Minibend KR	Item no.
63.5	minibend K-2.5	80337108	minibend KR-2.5	80337144
76.2	minibend K-3	80337117	minibend KR-3	80337149
88.9	minibend K-3.5	80337119	minibend KR-3.5	80366984
101.6	minibend K-4	80337121	minibend KR-4	80337152
114.3	minibend K-4.5	80337122	minibend KR-4.5	80362898
127	minibend K-5	80362456	minibend KR-5	80337154
139.7	minibend K-5.5	80337128	minibend KR-5.5	80370656
152.4	minibend K-6	80337129	minibend KR-6	80337156
165.1	minibend K-6.5	80365648	minibend KR-6.5	80370930
177.8	minibend K-7	80337130	minibend KR-7	80337157
203.2	minibend K-8	80337132	minibend KR-8	80337160
228.6	minibend K-9	80337134	minibend KR-9	80337161
254	minibend K-10	80337097	minibend KR-10	80337138
279.4	minibend K-11	80337098	minibend KR-11	80363429
304.8	minibend K-12	80337099	minibend KR-12	80337139
330.2	minibend K-13	80337100	minibend KR-13	80369274
355.6	minibend K-14	80337101	minibend KR-14	80337140
381	minibend K-15	80337102	minibend KR-15	80365529
406.4	minibend K-16	80337103	minibend KR-16	80337141

# Minibend KS

Minibend KS is the 40 GHz version of the original Minibend with a SK plug connector on one end and an SMP female connector that is DSCC and MIL-STD-348 compliant on the other. Minibend KS replaces custom length, predefined bend configuration 0.086 inch semi-rigid cables with standard, COTS, flexible coax cables for use as internal, point-to-point interconnections between RF modules.

- Frequency range up to 40 GHz
- Precision SK Minibend plug connector
- Precision SMP female connector mateable with Corning Gilbert GPO®
- Ruggedised version available "R"



Length mm	Minibend KS	Item no.
63.5	minibend KS-2.5	80365556
76.2	minibend KS-3	80367753
88.9	minibend KS-3.5	80374003
101.6	minibend KS-4	80368776
114.3	minibend KS-4.5	80374004
127	minibend KS-5	80337165
139.7	minibend KS-5.5	80374005
152.4	minibend KS-6	80337166
165.1	minibend KS-6.5	80374006
177.8	minibend KS-7	80374007
203.2	minibend KS-8	80362863
228.6	minibend KS-9	80365458
254	minibend KS-10	80362038
279.4	minibend KS-11	80374008
304.8	minibend KS-12	80337162
330.2	minibend KS-13	80374009
355.6	minibend KS-14	80374010
381	minibend KS-15	80367162
406.4	minibend KS-16	80363850

# Minibend KV

Minibend KV is a 40 GHz version of the original Minibend with a SK plug connector on one end and a 2.4 mm/1.85 mm compatible plug connector on the other. Minibend KV replaces custom lengths, predefined bend configuration 0.086 semi-rigid cable assemblies for use as internal, point-to-point interconnections between RF modules and in high bandwidth switching systems.

- Frequency range up to 40 GHz
- Precision SK Minibend plug connector
- Precision 2.4 mm/1.85 mm compatible plug connector
- Ruggedised version available "R"



Length mm	Minibend KV	Item no.
63.5	minibend KV-2.5	80337175
76.2	minibend KV-3	80337177
88.9	minibend KV-3.5	80360466
101.6	minibend KV-4	80337180
114.3	minibend KV-4.5	80337181
127	minibend KV-5	80337182
139.7	minibend KV-5.5	80337183
152.4	minibend KV-6	80337184
165.1	minibend KV-6.5	80370931
177.8	minibend KV-7	80337185
203.2	minibend KV-8	80337187
228.6	minibend KV-9	80337188
254	minibend KV-10	80337169
279.4	minibend KV-11	80370094
304.8	minibend KV-12	80337170
330.2	minibend KV-13	80370932
355.6	minibend KV-14	80337171
381	minibend KV-15	80370933
406.4	minibend KV-16	80337172



# Minibend QG

Minibend QG is a 50 GHz version of the original Minibend with a 2.4 mm plug connector on each end that contains a gold plated BeCu contact for applications that require repeated mates/demates of the interface. This flexible coaxial cable assembly is designed for use in low profile, internal point-to-point interconnections between RF modules within communications systems. Minibend QG replaces small custom semi-rigid cables with standard flexible cables, eliminating the need for predefined custom lengths and bend configurations. Minibend QG provides you with a preassembled and tested high performance, cost-effective alternative in a variety of standard lengths.

- Frequency range up to 50 GHz
- Precision 2.4 mm compatible plug connectors
- Automatically ruggedised by design



# Minibend S

Minibend S is a special version of the original Minibend that provides all the benefits of the original Minibend but with a precision DSCC and MIL-STD-348 compliant SMP female connector on one end and an SMA plug connector on the other. Minibend S replaces custom length, predefined bend configuration cable for use as internal, point-to-point interconnections between RF modules within communications and switching systems.

- Frequency range up to 24 GHz
- Precision stainless steel SMA plug connectors
- Precision SMP female connector mateable with Corning Gilbert GPO®
- Ruggedised version available "R"



Length mm	Minibend QG	Item no.
63.5	minibend QG-2.5	80370934
76.2	minibend QG-3	80361835
88.9	minibend QG-3.5	80370203
101.6	minibend QG-4	80337502
114.3	minibend QG-4.5	80367704
127	minibend QG-5	80365999
139.7	minibend QG-5.5	80370935
152.4	minibend QG-6	80362867
165.1	minibend QG-6.5	80366000
177.8	minibend QG-7	80371525
203.2	minibend QG-8	80337503
228.6	minibend QG-9	80371780
254	minibend QG-10	80363167
279.4	minibend QG-11	80367645
304.8	minibend QG-12	80362486
330.2	minibend QG-13	80370936
355.6	minibend QG-14	80370937
381	minibend QG-15	80370938
406.4	minibend QG-16	80370939

Length mm	Minibend S	Item no.	Minibend SR	Item no.
63.5	minibend S-2.5	80337655	minibend SR-2.5	80337687
76.2	minibend S-3	80337657	minibend SR-3	80337692
88.9	minibend S-3.5	80370940	minibend SR-3.5	80337693
101.6	minibend S-4	80337658	minibend SR-4	80337698
114.3	minibend S-4.5	80337660	minibend SR-4.5	80337699
127	minibend S-5	80337661	minibend SR-5	80337704
139.7	minibend S-5.5	80337662	minibend SR-5.5	80365201
152.4	minibend S-6	80337663	minibend SR-6	80337707
165.1	minibend S-6.5	80367381	minibend SR-6.5	80370944
177.8	minibend S-7	80337665	minibend SR-7	80337710
203.2	minibend S-8	80337666	minibend SR-8	80337712
228.6	minibend S-9	80337670	minibend SR-9	80362779
254	minibend S-10	80337641	minibend SR-10	80337678
279.4	minibend S-11	80337642	minibend SR-11	80337680
304.8	minibend S-12	80337644	minibend SR-12	80337681
330.2	minibend S-13	80365405	minibend SR-13	80370945
355.6	minibend S-14	80337646	minibend SR-14	80337682
381	minibend S-15	80337647	minibend SR-15	80370946
406.4	minibend S-16	80337649	minibend SR-16	80337683

# Minibend 2S

Minibend 2S is the SMP version of the original Minibend that provides all the benefits of the original Minibend but with precision DSCC and MIL-STD-348 compliant SMP female connections on each end. Minibend flexible coaxial cable assemblies are designed for use in low profile, internal point-to-point interconnections between RF modules. Minibend 2S is a cost-effective replacement for 0.086 inch semi-rigid cable and eliminates the need for predefined custom lengths and bend configurations.

- Frequency range up to 40 GHz
- Precision SMP female connector mateable with Corning Gilbert GPO®
- Ruggedised version available "R"



Length mm	Minibend S	Item no.	Minibend SR	Item no.
63.5	minibend 2S-2.5	80336924	minibend 2SR-2.5	80362615
76.2	minibend 2S-3	80336925	minibend 2SR-3	80369626
88.9	minibend 2S-3.5	80336926	minibend 2SR-3.5	80364002
101.6	minibend 2S-4	80336927	minibend 2SR-4	80369628
114.3	minibend 2S-4.5	80370941	minibend 2SR-4.5	80365267
127	minibend 2S-5	80336928	minibend 2SR-5	80336948
139.7	minibend 2S-5.5	80336929	minibend 2SR-5.5	80370947
152.4	minibend 2S-6	80336931	minibend 2SR-6	80336949
165.1	minibend 2S-6.5	80336932	minibend 2SR-6.5	80370948
177.8	minibend 2S-7	80336934	minibend 2SR-7	80369627
203.2	minibend 2S-8	80336937	minibend 2SR-8	80365390
228.6	minibend 2S-9	80336938	minibend 2SR-9	80336951
254	minibend 2S-10	80336918	minibend 2SR-10	80363144
279.4	minibend 2S-11	80336919	minibend 2SR-11	80370949
304.8	minibend 2S-12	80336920	minibend 2SR-12	80360902
330.2	minibend 2S-13	80370942	minibend 2SR-13	80370950
355.6	minibend 2S-14	80370943	minibend 2SR-14	80370951
381	minibend 2S-15	80365859	minibend 2SR-15	80365860
406.4	minibend 2S-16	80336921	minibend 2SR-16	80363112

# Minibend V

Minibend V is the millimeter wave version of the original Minibend, designed for use in high-speed (40 GB/sec.), low dispersion applications. Minibend V has a HUBER+SUHNER designed plug connector that mates with standard 1.85 mm and 2.4 mm connections.

- Frequency range up to 65 GHz
- Precision 2.4 mm/1.85 mm compatible plug connectors
- Automatically ruggedised by design



Length mm	Minibend V	Item no.
63.5	minibend V-2.5	80337735
76.2	minibend V-3	80337738
88.9	minibend V-3.5	80337740
101.6	minibend V-4	80337743
114.3	minibend V-4.5	80337745
127	minibend V-5	80337748
139.7	minibend V-5.5	80337750
152.4	minibend V-6	80337753
165.1	minibend V-6.5	80363214
177.8	minibend V-7	80337756
203.2	minibend V-8	80337760
228.6	minibend V-9	80337763
254	minibend V-10	80337721
279.4	minibend V-11	80337722
304.8	minibend V-12	80337723
330.2	minibend V-13	80370952
355.6	minibend V-14	80337727
381	minibend V-15	80363018
406.4	minibend V-16	80337729

# Minibend VG

Minibend VG is an enhanced version of the Minibend V with a 1.85 mm plug connector that contains a gold plated BeCu contact for applications that require repeated mates/demates of the interface. The Minibend VG will tolerate up to 500 mates/demates without applicable degradation. Minibend VG is designed for use in high bandwidth and high-speed (40 GB/sec) applications.

- Frequency range up to 65 GHz
- Precision 1.85 mm compatible plug connectors
- Automatically ruggedised by design



Length mm	Minibend V	Item no.
63.5	minibend V-2.5	80337735
76.2	minibend V-3	80337738
88.9	minibend V-3.5	80337740
101.6	minibend V-4	80337743
114.3	minibend V-4.5	80337745
127	minibend V-5	80337748
139.7	minibend V-5.5	80337750
152.4	minibend V-6	80337753
165.1	minibend V-6.5	80363214
177.8	minibend V-7	80337756
203.2	minibend V-8	80337760
228.6	minibend V-9	80337763
254	minibend V-10	80337721
279.4	minibend V-11	80337722
304.8	minibend V-12	80337723
330.2	minibend V-13	80370952
355.6	minibend V-14	80337727
381	minibend V-15	80363018
406.4	minibend V-16	80337729

# Minibend WR

Minibend WR is the "all weather" version of the Minibend family environments with high humidity and moisture. Minibend WR meets the moisture resistance requirements of MIL-STD-202, method 106. It is designed for use in low profile, internal or external, point-to-point interconnections between RF modules within communications systems. Minibend WR provides you with a preassembled and tested high performance, cost-effective alternative in a variety of standard lengths.

- Frequency range up to 26.5 GHz
- Precision stainless steel SMA plug connectors
- Automatically ruggedised and weatherproof by design

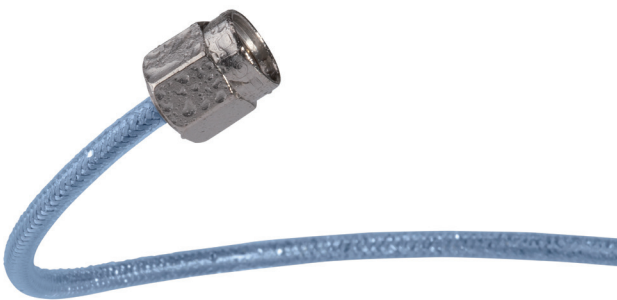

Length mm	Minibend WR	Item no.
63.5	minibend WR-2.5	80365802
76.2	minibend WR-3	80337821
88.9	minibend WR-3.5	80337822
101.6	minibend WR-4	80337824
114.3	minibend WR-4.5	80370956
127	minibend WR-5	80337826
139.7	minibend WR-5.5	80363605
152.4	minibend WR-6	80337827
165.1	minibend WR-6.5	80370957
177.8	minibend WR-7	80360521
203.2	minibend WR-8	80337830
228.6	minibend WR-9	80337832
254	minibend WR-10	80360440
279.4	minibend WR-11	80363606
304.8	minibend WR-12	80337814
330.2	minibend WR-13	80337815
355.6	minibend WR-14	80360441
381	minibend WR-15	80363222
406.4	minibend WR-16	80367832

# Minibend L

High performance/high pull strength, low loss microwave coaxial cable assembly

## Product description

Minibend L is an enhanced, low loss version of the Minibend flexible coaxial cable assembly with increased phase stability and power handling capacity which is designed for use in low profile, internal, point-to-point interconnections between RF modules within communications systems. Minibend L replaces 0.086 inch custom semi-rigid cables with standard flexible cables providing 30 % lower attenuation and eliminating the need for predefined custom lengths and bend configurations. Minibend L provides you with a preassembled and tested high performance, cost-effective alternative in a variety of standard lengths.

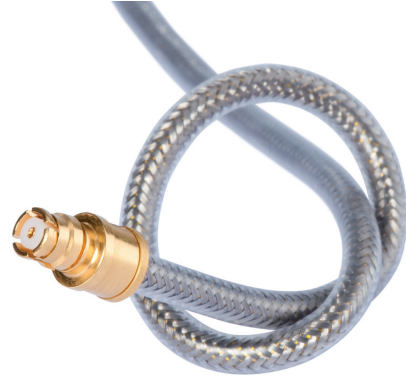

## Product features

- Impedance 50 Ω
- Applicable up to 50 GHz
- Direct replacement for 0.086 inch semi-rigid cables
- Stock delivery on standard lengths
- Microporous dielectric for 30 % lower insertion loss, improved phase stability and higher power handling

## Recommended connectors

Minibend L	SMA, SSMA, SMP
	Other connectors available on request

## Construction

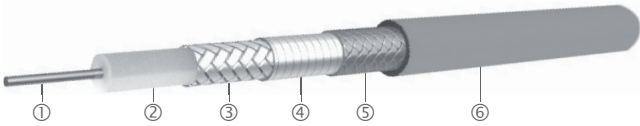

Cable	Inner conductor ①	Dielectric ②	Outer conductor ③	Barrier ④	Outer braid ⑤	Jacket ⑥	Outer diameter mm
32024	CuAg wire	PTFE microporous	CuAg flat wire braid	aluminium/ polyimide tape	stainless steel	FEP	2.7

## Technical data

Cable	Operating frequency GHz	Velocity %	Weight g/m	Min. bending radius for ± 180° mm	Temperature range ° C
32024	50	76.0	16.4	5.08	-55 to +200

Assembly	Minibend L	Minibend LS	Minibend L2S	Minibend LA
Connector A	SMA (m)	SMA (m)	SMP (f)	SSMA (m)
Connector B	SMA (m)	SMP (f)	SMP (f)	SSMA (m)

# Minibend L

Attenuation (nominal values at +25 °C ambient temperature)

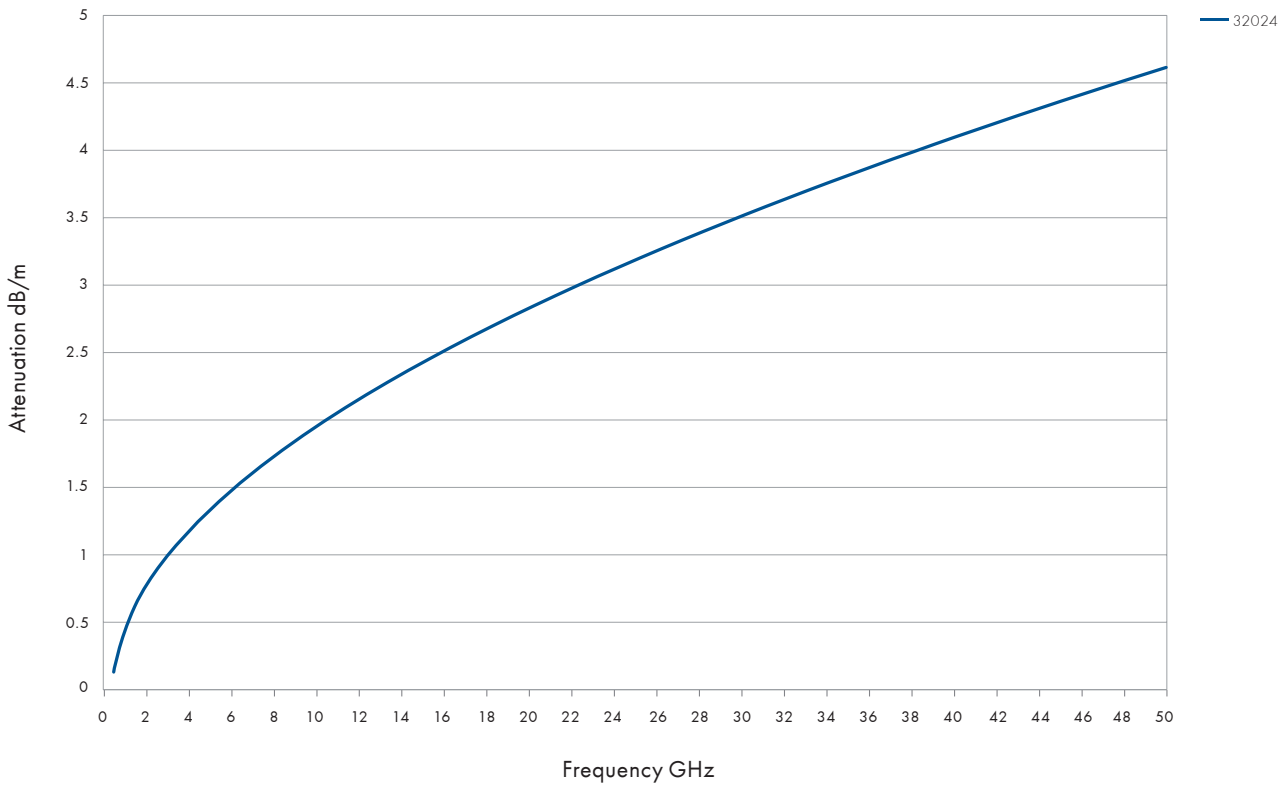

Power handling (maximum values at 25 °C ambient temperature and sea level)

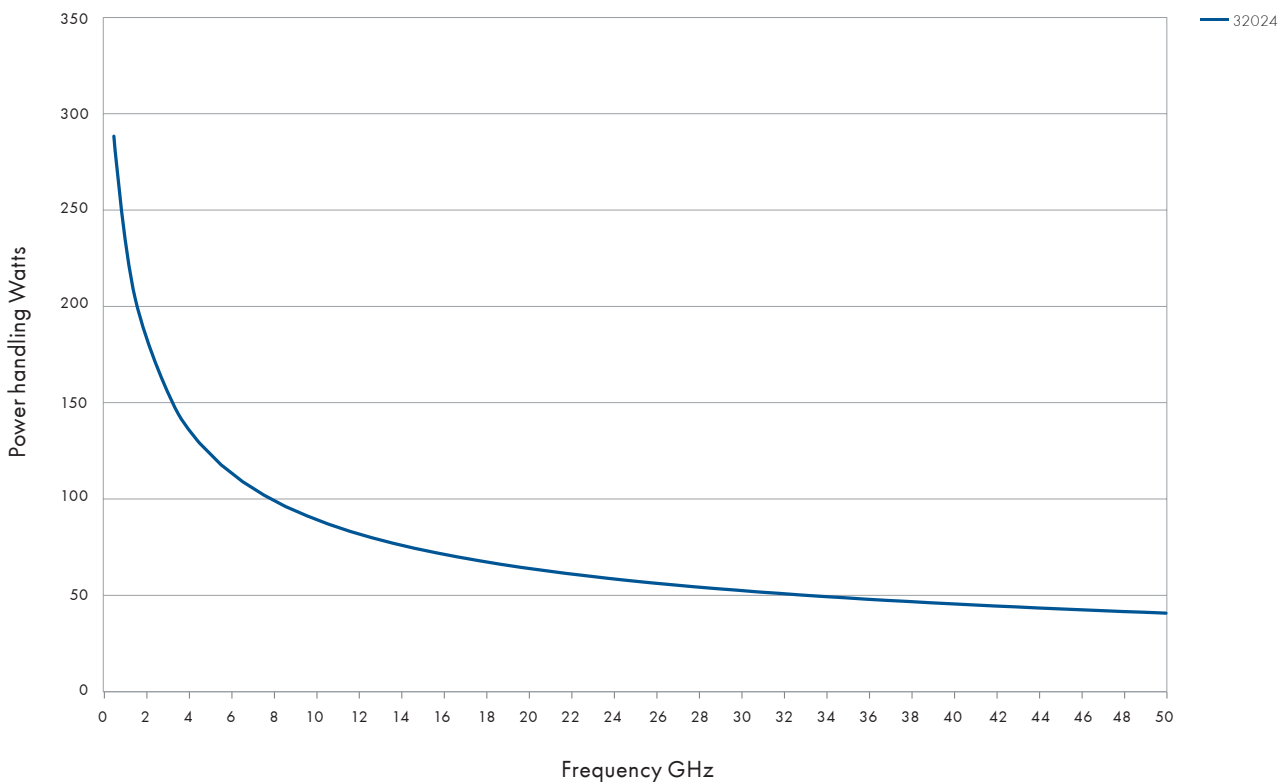

Low profile assemblies

# Minibend L

Minibend L is an enhanced, low loss version of the Minibend flexible coaxial cable assembly which is designed for use in low profile, internal, point-to-point interconnections between RF modules within communications systems. Minibend L eliminates the need for predefined custom lengths and bend configurations. Minibend L provides you with a preassembled and tested high performance, cost-effective alternative in a variety of standard lengths.

- Frequency range up to 26.5 GHz
- Precision stainless steel SMA plug connectors
- Ruggedised version available "R"



Length mm	Minibend L	Item no.	Minibend LR	Item no.
63.5	minibend L-2.5	80360176	minibend LR-2.5	80337368
76.2	minibend L-3	80337272	minibend LR-3	80337390
88.9	minibend L-3.5	80337273	minibend LR-3.5	80337392
101.6	minibend L-4	80337285	minibend LR-4	80337409
114.3	minibend L-4.5	80337286	minibend LR-4.5	80337412
127	minibend L-5	80337292	minibend LR-5	80337423
139.7	minibend L-5.5	80337293	minibend LR-5.5	80337427
152.4	minibend L-6	80337298	minibend LR-6	80337433
165.1	minibend L-6.5	80337299	minibend LR-6.5	80337435
177.8	minibend L-7	80337304	minibend LR-7	80337443
203.2	minibend L-8	80337313	minibend LR-8	80337449
228.6	minibend L-9	80337318	minibend LR-9	80337451
254	minibend L-10	80337198	minibend LR-10	80337344
279.4	minibend L-11	80337201	minibend LR-11	80337348
304.8	minibend L-12	80337202	minibend LR-12	80337351
330.2	minibend L-13	80337207	minibend LR-13	80337355
355.6	minibend L-14	80337209	minibend LR-14	80337356
381	minibend L-15	80337212	minibend LR-15	80337357
406.4	minibend L-16	80337213	minibend LR-16	80337358

# Minibend LS

Minibend LS has all of the benefits of the original Minibend but with a microporous dielectric for lower loss and improved phase stability. The assembly contains a DSCC and MIL-STD-348 compliant SMP female connector on one end and an SMA plug connector on the other. Minibend LS replaces custom length and predefined 0.086 inch semi-rigid cables with flexible coax cable assemblies for use as internal, point-to-point interconnections between RF modules.

- Frequency range up to 26.5 GHz
- Precision stainless steel SMA plug connector
- Precision SMP female connector mateable with Corning Gilbert GPO®
- Ruggedised version available "R"



Length mm	Minibend LS	Item no.
63.5	minibend LS-2.5	80337463
76.2	minibend LS-3	80337464
88.9	minibend LS-3.5	80337465
101.6	minibend LS-4	80337466
114.3	minibend LS-4.5	80337467
127	minibend LS-5	80337468
139.7	minibend LS-5.5	80337469
152.4	minibend LS-6	80337470
165.1	minibend LS-6.5	80337471
177.8	minibend LS-7	80337475
203.2	minibend LS-8	80337477
228.6	minibend LS-9	80360501
254	minibend LS-10	80337455
279.4	minibend LS-11	80337456
304.8	minibend LS-12	80337457
330.2	minibend LS-13	80337458
355.6	minibend LS-14	80337459
381	minibend LS-15	80337460
406.4	minibend LS-16	80337461

# Minibend L2S

Minibend L2S is the SMP female version of the original Minibend with a lower loss, microporous dielectric and DSCC and MIL-STD-348 compliant SMP female connectors on each end. Minibend L2S replaces custom length and bend configuration 0.086 inch semi-rigid cable with truly flexible coax cable assemblies for use as internal interconnections between RF modules.

- Frequency range up to 40 GHz
- Precision SMP female connector mateable with Corning Gilbert GPO®
- Ruggedised version available "R"



# Minibend LA

Minibend LA is the SSMA plug version of the original Minibend with a microporous dielectric for lower loss and improved phase stability. Minibend LA replaces custom length and predefined bend configuration 0.086 inch semi-rigid cables with truly flexible coax cable assemblies for use as internal point-to-point interconnections between RF modules.

- Frequency range up to 40 GHz
- Precision stainless steel SSMA plug connectors
- Ruggedised version available "R"



Length mm	Minibend L2S	Item no.
63.5	minibend L2S-2.5	80337249
76.2	minibend L2S-3	80362626
88.9	minibend L2S-3.5	80367351
101.6	minibend L2S-4	80366004
114.3	minibend L2S-4.5	80337250
127	minibend L2S-5	80363891
139.7	minibend L2S-5.5	80337251
152.4	minibend L2S-6	80365111
165.1	minibend L2S-6.5	80367341
177.8	minibend L2S-7	80370924
203.2	minibend L2S-8	80366005
228.6	minibend L2S-9	80361796
254	minibend L2S-10	80362894
279.4	minibend L2S-11	80370911
304.8	minibend L2S-12	80365427
330.2	minibend L2S-13	80366870
355.6	minibend L2S-14	80366871
381	minibend L2S-15	80366872
406.4	minibend L2S-16	80337248

Length mm	Minibend L2S	Item no.
63.5	minibend LA-2.5	80370912
76.2	minibend LA-3	80366857
88.9	minibend LA-3.5	80370913
101.6	minibend LA-4	80366135
114.3	minibend LA-4.5	80370914
127	minibend LA-5	80370915
139.7	minibend LA-5.5	80370916
152.4	minibend LA-6	80366858
165.1	minibend LA-6.5	80365398
177.8	minibend LA-7	80370917
203.2	minibend LA-8	80366622
228.6	minibend LA-9	80366841
254	minibend LA-10	80370918
279.4	minibend LA-11	80370919
304.8	minibend LA-12	80370920
330.2	minibend LA-13	80370921
355.6	minibend LA-14	80370922
381	minibend LA-15	80370923
406.4	minibend LA-16	80365399



# Microbend

High performance/high pull strength microwave coaxial cable assembly

## Product description

Microbend assemblies provide you with a standard preassembled and tested high performance, cost-effective truly flexible alternative to 0.047 inch custom semi-rigid cable assemblies, eliminating the need for predefined custom lengths and bend configurations. Microbend features include 35 % lower loss than 0.047 inch semi-rigid cable, a minimum bend radius of 1.52 mm (0.060 inch) and triple shielding for high isolation. Microbend assemblies are available with a wide range of connector interfaces. All Microbend assemblies are available only in a ruggedised version.



## Product features

- Impedance 50 Ω
- Applicable up to 67 GHz
- Stock delivery on standard lengths
- 35 % lower insertion loss than 0.047 inch semi-rigid cables

## Recommended connectors

Microbend	SMA, SSMA, SK, SMP, SMPM, SMPM-T, 1.85 mm
	Other connectors available on request

## Construction



Cable	Inner conductor ①	Dielectric ②	Outer conductor ③	Barrier ④	Outer braid ⑤	Jacket ⑥	Outer diameter mm
32041	CuAg wire	PTFE	CuAg flat wire braid	aluminium/ polyimide tape	stainless steel	FEP	2.0

## Technical data

Cable	Operating frequency GHz	Velocity %	Weight g/m	Min. bending radius for ± 180° mm	Temperature range ° C
32041	90	70.3	11.9	1.50	-55 to +200

Assembly	Microbend R	Microbend AR	Microbend KR	Microbend KMR	Microbend KMTR	Microbend KV	Microbend MR
Connector A	SMA (m)	SSMA (m)	SK (m)	SK (m)	SK (m)	SK (m)	SMA (m)
Connector B	SMA (m)	SSMA (m)	SK (m)	SMPM (f)	SMPM-T(f)	1.85 mm (m) gold plated BeCu	SMPM (f)

Assembly	Microbend 2MR	Microbend MTR	Microbend 2MTR	Microbend MVR	Microbend SR	Microbend 2SR	Microbend V
Connector A	SMPM (f)	SMA (m)	SMPM-T(f)	SMPM (f)	SMA (m)	SMP (f)	1.85 mm (m) gold plated BeCu
Connector B	SMPM (f)	SMPM-T(f)	SMPM-T(f)	1.85 mm (m) gold plated BeCu	SMP (f)	SMP (f)	1.85 mm (m) gold plated BeCu



# Microbend

Attenuation (nominal values at +25 °C ambient temperature)

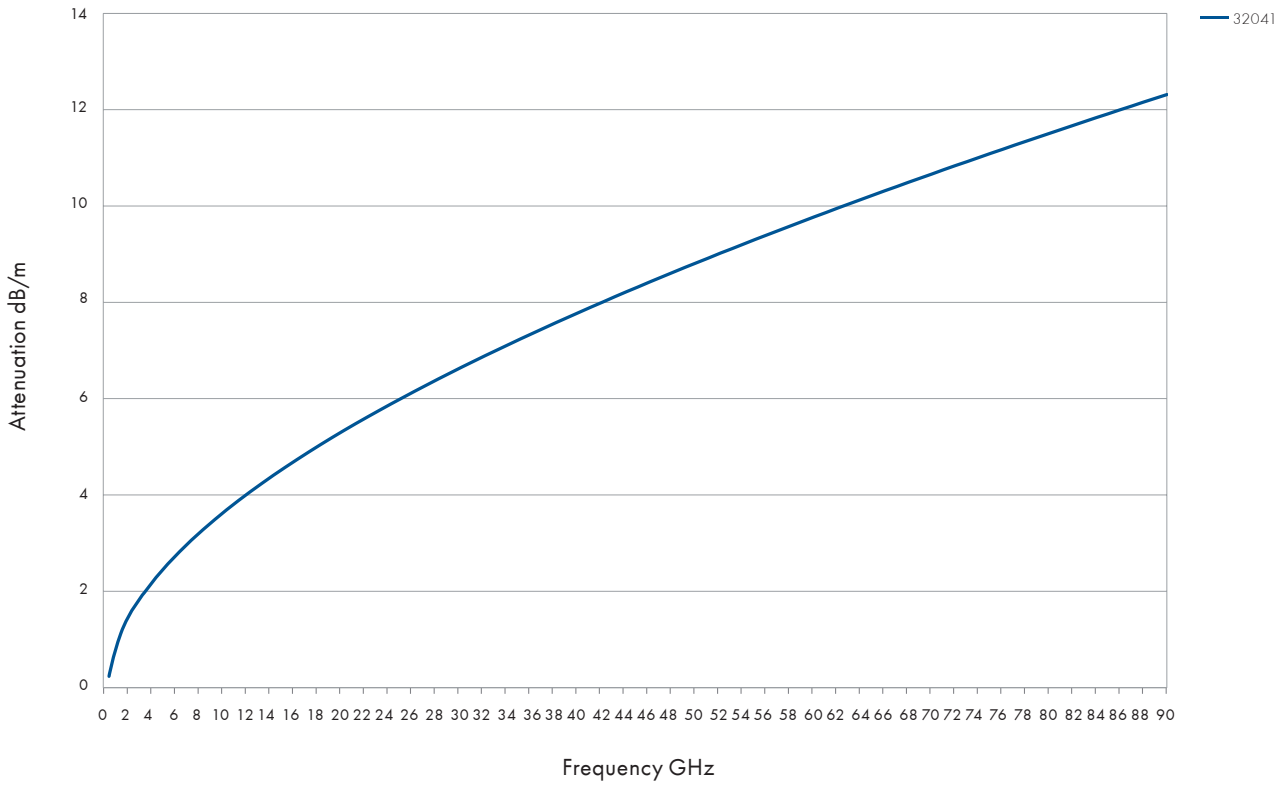

Power handling (maximum values at 25 °C ambient temperature and sea level)

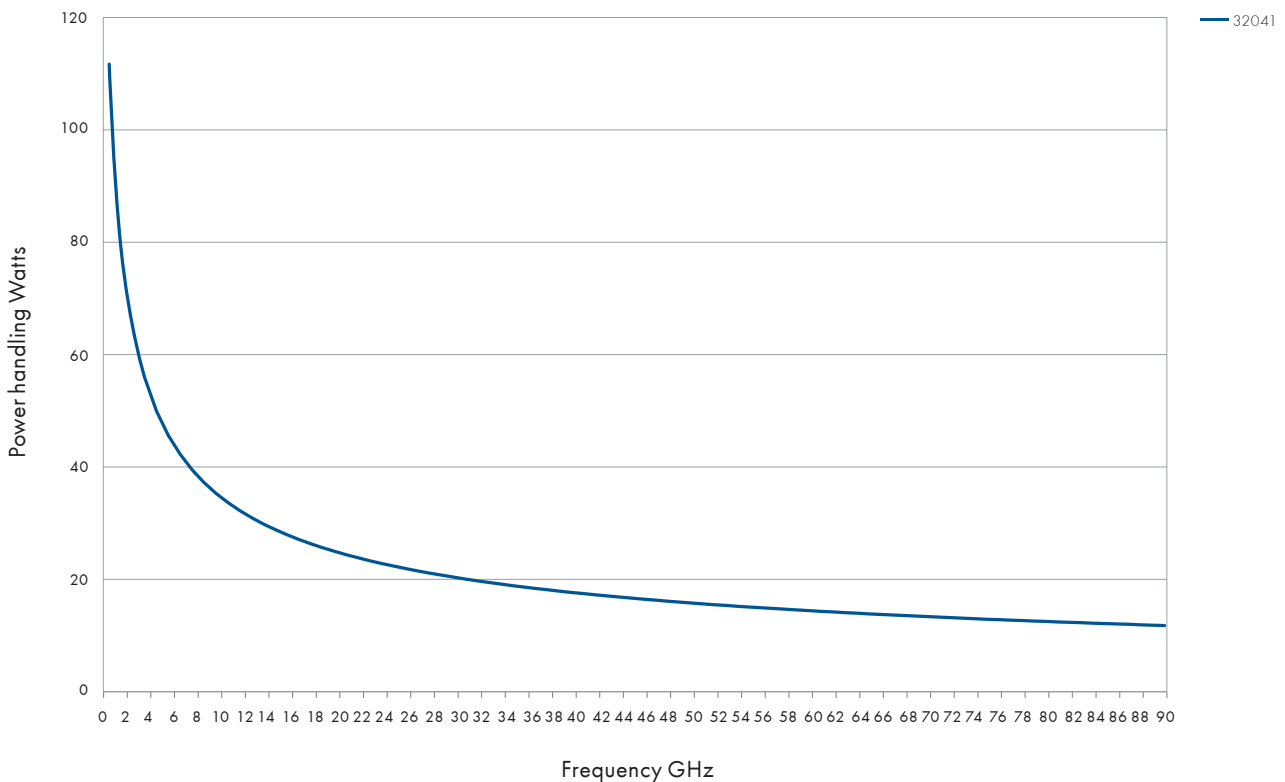

Low profile assemblies

# Microbend R

Microbend R eliminates the need for predefined custom lengths and bend configurations. Microbend R was designed for use as internal point-to-point interconnections between modules in microwave and fiber optic switching systems. Microbend R features include lower loss than 0.047 inch semi-rigid cable and a minimum bend radius of 1.52 mm (0.060 inch).

- Frequency range up to 26.5 GHz
- Precision stainless steel SMA plug connectors
- Automatically ruggedised by design

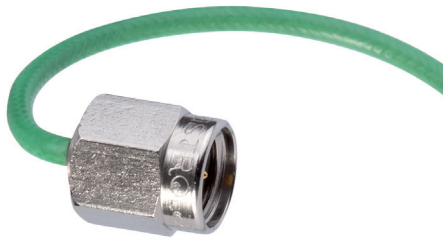

Length mm	Microbend R	Item no.
63.5	microbend R-2.5	80336652
76.2	microbend R-3	80336654
88.9	microbend R-3.5	80336655
101.6	microbend R-4	80336658
114.3	microbend R-4.5	80336659
127	microbend R-5	80336662
139.7	microbend R-5.5	80336664
152.4	microbend R-6	80336665
165.1	microbend R-6.5	80363961
177.8	microbend R-7	80336667
203.2	microbend R-8	80336668
228.6	microbend R-9	80336669
254	microbend R-10	80336646
279.4	microbend R-11	80336648
304.8	microbend R-12	80336649

# Microbend AR

Microbend AR is the SSMA plug version of the of the Microbend. Microbend AR replaces custom length, predefined bend configuration 0.047 inch semi-rigid cable with truly flexible coax cable in standard lengths.

- Frequency range up to 40 GHz
- Precision stainless steel SSMA plug connectors
- Automatically ruggedised by design



Length mm	Microbend AR	Item no.
63.5	microbend AR-2.5	80370830
76.2	microbend AR-3	80370831
88.9	microbend AR-3.5	80370832
101.6	microbend AR-4	80336531
114.3	microbend AR-4.5	80370833
127	microbend AR-5	80363838
139.7	microbend AR-5.5	80370834
152.4	microbend AR-6	80336532
165.1	microbend AR-6.5	80370835
177.8	microbend AR-7	80370836
203.2	microbend AR-8	80336533
228.6	microbend AR-9	80370837
254	microbend AR-10	80336529
279.4	microbend AR-11	80370838
304.8	microbend AR-12	80362731

# Microbend KR

Microbend KR offers all the benefits of the Microbend cable assembly but with a solderless SK plug connector on each end for performance up to 40 GHz. Microbend KR replaces custom length, predefined bend configuration 0.047 inch semi-rigid cable with standard length, truly flexible coax cable for use as internal interconnections between RF modules in communications and high bandwidth switching systems.

- Frequency range up to 40 GHz
- Precision stainless steel SK plug connectors
- Automatically ruggedised by design



Length mm	Microbend KR	Item no.
63.5	microbend KR-2.5	80336568
76.2	microbend KR-3	80336570
88.9	microbend KR-3.5	80336571
101.6	microbend KR-4	80336573
114.3	microbend KR-4.5	80360390
127	microbend KR-5	80336574
139.7	microbend KR-5.5	80336575
152.4	microbend KR-6	80336576
165.1	microbend KR-6.5	80367544
177.8	microbend KR-7	80336578
203.2	microbend KR-8	80336579
228.6	microbend KR-9	80336580
254	microbend KR-10	80336562
279.4	microbend KR-11	80336563
304.8	microbend KR-12	80336564

# Microbend KMR

Microbend KMR offers all the benefits of the Microbend but with a solderless SK plug on one end and an SMPM female connector compliant with MIL-STD-348 on the other. Microbend KMR replaces custom length, predefined bend configuration 0.047 inch semi-rigid cable with standard length truly flexible coax cable.

- Frequency range up to 40 GHz
- Precision stainless steel SK plug connector
- Precision SMPM female connector mateable with Corning Gilbert GPPO®
- Automatically ruggedised by design



Length mm	Microbend KMR	Item no.
63.5	microbend KMR-2.5	80336550
76.2	microbend KMR-3	80336552
88.9	microbend KMR-3.5	80336553
101.6	microbend KMR-4	80336554
114.3	microbend KMR-4.5	80336555
127	microbend KMR-5	80336556
139.7	microbend KMR-5.5	80336557
152.4	microbend KMR-6	80336558
165.1	microbend KMR-6.5	80362862
177.8	microbend KMR-7	80336559
203.2	microbend KMR-8	80336560
228.6	microbend KMR-9	80336561
254	microbend KMR-10	80336545
279.4	microbend KMR-11	80336546
304.8	microbend KMR-12	80336547

## Microbend KMTR

Microbend KMTR offers all the benefits of the Microbend in a 40 GHz, high bandwidth cable assembly that features an SMPM-T female connector compliant with MIL-STD-348 on one end and a SK plug connector on the other. Microbend KMTR replaces custom length, predefined bend configuration 0.047 inch semi-rigid cable with truly flexible, standard length coax cable for use as internal interconnections between modules in microwave and optical fiber switching. It is also used extensively in space applications.

- Frequency range up to 40 GHz
- Precision stainless steel SK plug connector
- Precision SMPM-T female connector mateable with Corning Gilbert GPPO®
- Automatically ruggedised by design

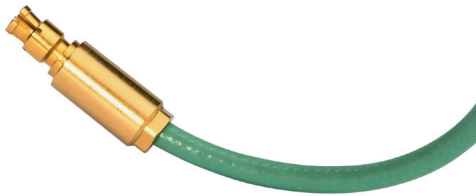

Length mm	Microbend KMTR	Item no.
63.5	microbend KMTR-2.5	80370885
76.2	microbend KMTR-3	80370886
88.9	microbend KMTR-3.5	80370887
101.6	microbend KMTR-4	80370312
114.3	microbend KMTR-4.5	80370888
127	microbend KMTR-5	80371852
139.7	microbend KMTR-5.5	80370889
152.4	microbend KMTR-6	80362186
165.1	microbend KMTR-6.5	80370890
177.8	microbend KMTR-7	80370891
203.2	microbend KMTR-8	80365259
228.6	microbend KMTR-9	80370892
254	microbend KMTR-10	80369837
279.4	microbend KMTR-11	80370893
304.8	microbend KMTR-12	80362144

## Microbend KV

Microbend KV offers all the benefits of the Microbend in a 40 GHz, high bandwidth cable assembly with an SK plug connector on one end and a 1.85 mm plug connector containing a gold plated BeCu contact for those applications that require repeated mates/demates of the interface, on the other. Microbend KV replaces custom length, predefined bend configuration 0.047 inch semi-rigid cable with truly flexible, standard length coax cable for use as internal interconnections between modules in microwave and optical fiber switching systems.

- Frequency range up to 40 GHz
- 1.85 mm plug connector
- Precision stainless steel SK plug connector
- Automatically ruggedised by design



Length mm	Microbend KV	Item no.
63.5	microbend KV-2.5	80336581
76.2	microbend KV-3	80370869
88.9	microbend KV-3.5	80370870
101.6	microbend KV-4	80363709
114.3	microbend KV-4.5	80370871
127	microbend KV-5	80370872
139.7	microbend KV-5.5	80370873
152.4	microbend KV-6	80336582
165.1	microbend KV-6.5	80370874
177.8	microbend KV-7	80370875
203.2	microbend KV-8	80370876
228.6	microbend KV-9	80370877
254	microbend KV-10	80370878
279.4	microbend KV-11	80370879
304.8	microbend KV-12	80369706

# Microbend MR

Microbend MR offers the benefits of the Microbend but with an SMA plug connector on one end and an SMPM female connector compliant with MIL-STD-348 on the other. Microbend MR replaces custom length, predefined bend configuration 0.047 inch semi-rigid cable with truly flexible, standard length cable.

- Frequency range up to 26.5 GHz
- Precision stainless steel SMA plug connector
- Precision SMPM female connector mateable with Corning Gilbert GPPO®
- Automatically ruggedised by design



Length mm	Microbend MR	Item no.
63.5	microbend MR-2.5	80336593
76.2	microbend MR-3	80336595
88.9	microbend MR-3.5	80336596
101.6	microbend MR-4	80336598
114.3	microbend MR-4.5	80370842
127	microbend MR-5	80336599
139.7	microbend MR-5.5	80336600
152.4	microbend MR-6	80336603
165.1	microbend MR-6.5	80370843
177.8	microbend MR-7	80365284
203.2	microbend MR-8	80336605
228.6	microbend MR-9	80365285
254	microbend MR-10	80360212
279.4	microbend MR-11	80336588
304.8	microbend MR-12	80336590

# Microbend 2MR

Microbend 2MR offers all the benefits of the Microbend but with SMPM female connectors on each end that are fully compliant with MIL-STD-348. Microbend 2MR replaces custom length, predefined bend configuration 0.047 inch semi-rigid cable with truly flexible coax cable in standard lengths.

- Frequency range up to 65 GHz
- Precision SMPM female connectors mateable with Corning Gilbert GPPO®
- Automatically ruggedised by design



Length mm	Microbend 2MR	Item no.
63.5	microbend 2MR-2.5	80336485
76.2	microbend 2MR-3	80336490
88.9	microbend 2MR-3.5	80362597
101.6	microbend 2MR-4	80336496
114.3	microbend 2MR-4.5	80370033
127	microbend 2MR-5	80336500
139.7	microbend 2MR-5.5	80370844
152.4	microbend 2MR-6	80336501
165.1	microbend 2MR-6.5	80370845
177.8	microbend 2MR-7	80362973
203.2	microbend 2MR-8	80336507
228.6	microbend 2MR-9	80336509
254	microbend 2MR-10	80336477
279.4	microbend 2MR-11	80336478
304.8	microbend 2MR-12	80336480

## Microbend MTR

Microbend MTR offers all the benefits of the Microbend in a 26.5 GHz, high bandwidth cable assembly that features an SMPM-T female connector compliant with MIL-STD-348 on one end and a SMA plug connector on the other. Microbend MTR replaces custom length, predefined bend configuration 0.047 inch semi-rigid cable with truly flexible, standard length coax cable for use as internal interconnections between modules in microwave and optical fiber switching. It is also used extensively in space applications.

- Frequency range up to 26.5 GHz
- Precision stainless steel SMA plug connector
- Precision SMPM-T female connector mateable with Corning Gilbert GPPO®
- Automatically ruggedised by design

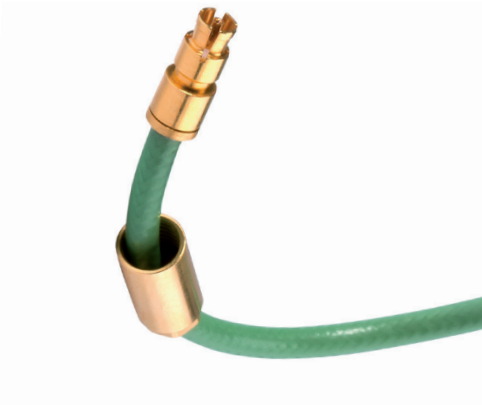

Length mm	Microbend MTR	Item no.
63.5	microbend MTR-2.5	80370846
76.2	microbend MTR-3	80371995
88.9	microbend MTR-3.5	80370847
101.6	microbend MTR-4	80366736
114.3	microbend MTR-4.5	80370848
127	microbend MTR-5	80366725
139.7	microbend MTR-5.5	80370849
152.4	microbend MTR-6	80361103
165.1	microbend MTR-6.5	80370850
177.8	microbend MTR-7	80366726
203.2	microbend MTR-8	80396610
228.6	microbend MTR-9	80362047
254	microbend MTR-10	80366737
279.4	microbend MTR-11	80370851
304.8	microbend MTR-12	80362145

## Microbend 2MTR

Microbend 2MTR offers all the benefits of the Microbend MTR in a 40 GHz, high bandwidth cable assembly that features an SMPM-T female connector compliant with MIL-STD-348 on each side. Microbend 2MTR replaces custom length, predefined bend configuration 0.047 inch semi-rigid cable with truly flexible, standard length coax cable for use as internal interconnections between modules in microwave and optical fiber switching. It is also used extensively in space applications.

- Frequency range up to 65 GHz
- Precision SMPM-T female connectors mateable with Corning Gilbert GPPO®
- Automatically ruggedised by design



Length mm	Microbend 2MTR	Item no.
63.5	microbend 2MTR-2.5	80370855
76.2	microbend 2MTR-3	80366641
88.9	microbend 2MTR-3.5	80367802
101.6	microbend 2MTR-4	80370856
114.3	microbend 2MTR-4.5	80366674
127	microbend 2MTR-5	80367803
139.7	microbend 2MTR-5.5	80370857
152.4	microbend 2MTR-6	80365945
165.1	microbend 2MTR-6.5	80370858
177.8	microbend 2MTR-7	80367804
203.2	microbend 2MTR-8	80360654
228.6	microbend 2MTR-9	80367805
254	microbend 2MTR-10	80367172
279.4	microbend 2MTR-11	80370859
304.8	microbend 2MTR-12	80362560

# Microbend MVR

Microbend MVR offers all the benefits of the Microbend in a 65 GHz, high bandwidth cable assembly that features an SMPM female connector compliant with MIL-STD-348 on one end and a 1.85 mm plug connector containing a gold plated BeCu contact for those applications that require repeated mates/demates of the interface on the other. Microbend MVR replaces custom length, predefined bend configuration 0.047 inch semi-rigid cable with truly flexible, standard length coax cable for use as internal interconnections between modules in microwave and optical fiber switching systems.

- Frequency range up to 65 GHz
- 1.85 mm plug connector
- Precision SMPM female connector mateable with Corning Gilbert GPPO®
- Automatically ruggedised by design



# Microbend SR

Microbend SR offers the benefits of the standard Microbend with an SMA plug connector on one end and a DSCC and MIL-STD-348 compliant SMP female connector on the other. Microbend SR replaces custom length, predefined bend configuration 0.047 inch semi-rigid cable with truly flexible, cost-effective, standard length coax cables for use as internal interconnections between RF modules of communications systems.

- Frequency range up to 26.5 GHz
- Precision stainless steel SMA plug connector
- Precision SMP female connector mateable with Corning Gilbert GPO®
- Automatically ruggedised by design



Length mm	Microbend MVR	Item no.
63.5	microbend MVR-2.5	80336620
76.2	microbend MVR-3	80336623
88.9	microbend MVR-3.5	80336626
101.6	microbend MVR-4	80336633
114.3	microbend MVR-4.5	80370862
127	microbend MVR-5	80336638
139.7	microbend MVR-5.5	80370863
152.4	microbend MVR-6	80336640
165.1	microbend MVR-6.5	80370864
177.8	microbend MVR-7	80336641
203.2	microbend MVR-8	80336643
228.6	microbend MVR-9	80336645
254	microbend MVR-10	80336613
279.4	microbend MVR-11	80370865
304.8	microbend MVR-12	80336614

Length mm	Microbend SR	Item no.
63.5	microbend SR-2.5	80336674
76.2	microbend SR-3	80366686
88.9	microbend SR-3.5	80336676
101.6	microbend SR-4	80336677
114.3	microbend SR-4.5	80363639
127	microbend SR-5	80336679
139.7	microbend SR-5.5	80363701
152.4	microbend SR-6	80336681
165.1	microbend SR-6.5	80366676
177.8	microbend SR-7	80336684
203.2	microbend SR-8	80336685
228.6	microbend SR-9	80336686
254	microbend SR-10	80370899
279.4	microbend SR-11	80370900
304.8	microbend SR-12	80336671



## Microbend 2SR

Microbend 2SR offers all of the benefits of the standard Microbend but with DSCC and MIL-STD-348 compliant SMP female connectors on each end. Microbend 2SR replaces custom length, predefined bend configuration 0.047 inch semi-rigid cable with truly flexible, standard length, cost-effective coax cable for use as internal interconnections between RF modules in communications systems.

- Frequency range up to 40 GHz
- Precision SMP female connectors mateable with Corning Gilbert GPO®
- Automatically ruggedised by design



Length mm	Microbend 2SR	Item no.
63.5	microbend 2SR-2.5	80336515
76.2	microbend 2SR-3	80336518
88.9	microbend 2SR-3.5	80365453
101.6	microbend 2SR-4	80336521
114.3	microbend 2SR-4.5	80366525
127	microbend 2SR-5	80336522
139.7	microbend 2SR-5.5	80336523
152.4	microbend 2SR-6	80336524
165.1	microbend 2SR-6.5	80365939
177.8	microbend 2SR-7	80365452
203.2	microbend 2SR-8	80336525
228.6	microbend 2SR-9	80365455
254	microbend 2SR-10	80363819
279.4	microbend 2SR-11	80365454
304.8	microbend 2SR-12	80362685

## Microbend V

Microbend V is the millimeter wave version of the Microbend and was designed for use in high-speed (40 Gb/sec.) switching applications such as in fiber optic communications. Microbend V has precision 1.85 mm plug connectors on each end that contain a gold plated BeCu contact for applications that require repeated mates/demates of the interface. Microbend V replaces custom length, predefined bend configuration 0.047 inch semi-rigid cables with truly flexible, cost-effective, standard lengths.

- Frequency range up to 65 GHz
- Precision 1.85 mm compatible plug connectors
- Automatically ruggedised by design



Length mm	Microbend V	Item no.
63.5	microbend V-2.5	80336690
76.2	microbend V-3	80336692
88.9	microbend V-3.5	80336693
101.6	microbend V-4	80336695
114.3	microbend V-4.5	80336696
127	microbend V-5	80366545
139.7	microbend V-5.5	80365644
152.4	microbend V-6	80336700
165.1	microbend V-6.5	80370906
177.8	microbend V-7	80370907
203.2	microbend V-8	80366953
228.6	microbend V-9	80365792
254	microbend V-10	80336689
279.4	microbend V-11	80370908
304.8	microbend V-12	80362488



# Mini141

High performance/high pull strength, low loss microwave coaxial cable assembly

## Product description

Mini141 is an enhanced, low loss version of the Minibend flexible coaxial cable assembly with increased phase stability and power handling capacity which is designed for use in low profile, internal, point-to-point interconnections between RF modules within communications systems. Mini141 replaces 0.141 inch custom semi-rigid cables with standard flexible cables providing 20 % lower attenuation and eliminating the need for predefined custom lengths and bend configurations. Mini141 provides you with a preassembled and tested high performance, cost-effective alternative in a variety of standard lengths.



Low profile assemblies

## Product features

- Impedance 50 Ω
- Applicable up to 40 GHz
- Direct replacement for 0.141 inch semi-rigid cables
- Stock delivery on standard lengths
- Microporous dielectric for 20 % lower insertion loss, improved phase stability and higher power handling

## Recommended connectors

mini141	SMA, N, TNCA, SK
	Other connectors available on request

## Construction

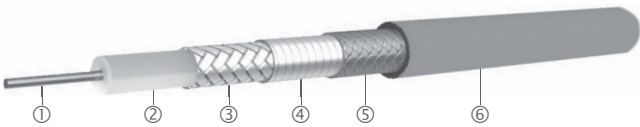

Cable	Inner conductor ①	Dielectric ②	Outer conductor ③	Barrier ④	Outer braid ⑤	Jacket ⑥	Outer diameter mm
32022	CuAg wire	PTFE microporous	CuAg flat wire braid	aluminium/ polyimide tape	stainless steel	FEP	3.7

## Technical data

Cable	Operating frequency GHz	Velocity %	Weight g/m	Min. bending radius for ± 180° mm	Temperature range ° C
32022	40	76.3	31.3	8.40	-55 to +200

Assembly	Mini141	Mini141 K	Mini141 N	Mini141 T	Mini141 W
Connector A	SMA (m)	SK (m)	N (m)	ATNC (m)	SMA (m)
Connector B	SMA (m)	SK (m)	N (m)	ATNC (m)	SMA (m)

# Mini141

Attenuation (nominal values at +25 °C ambient temperature)

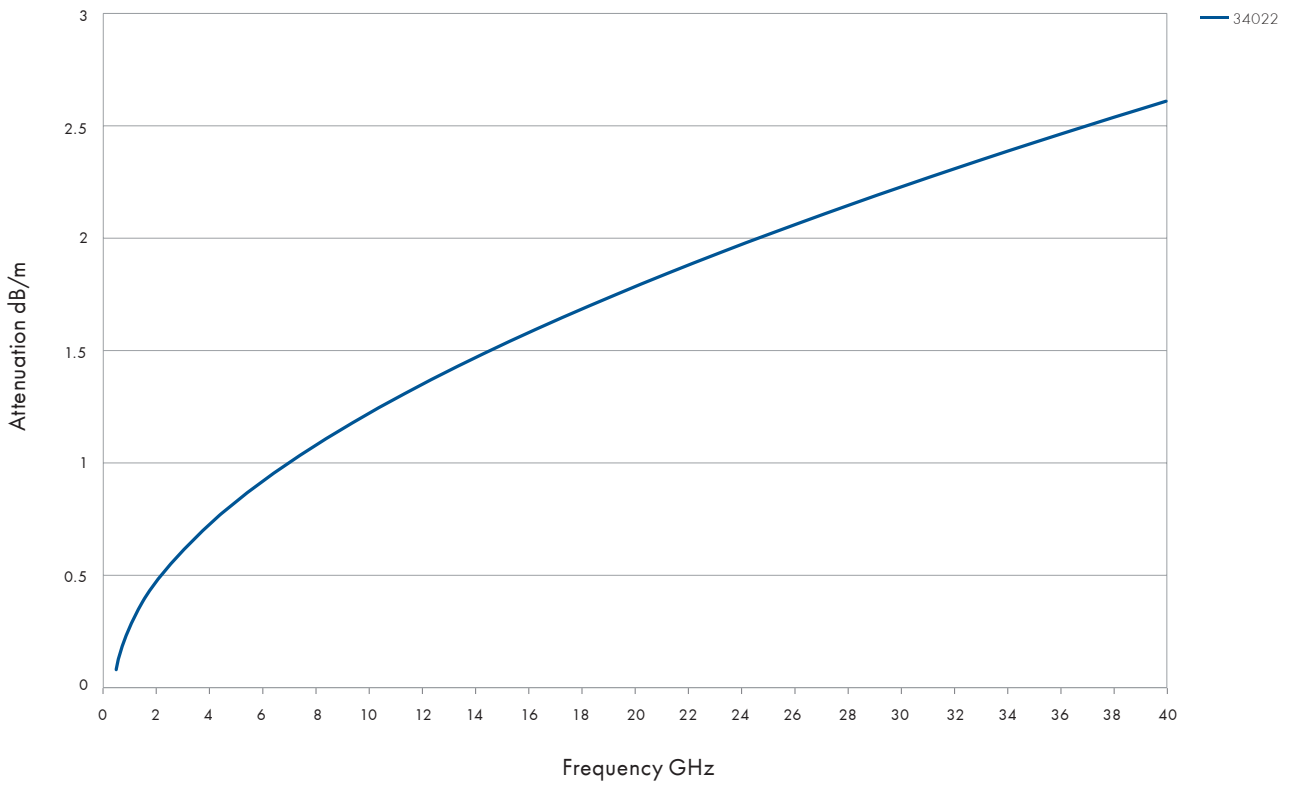

Power handling (maximum values at 25 °C ambient temperature and sea level)

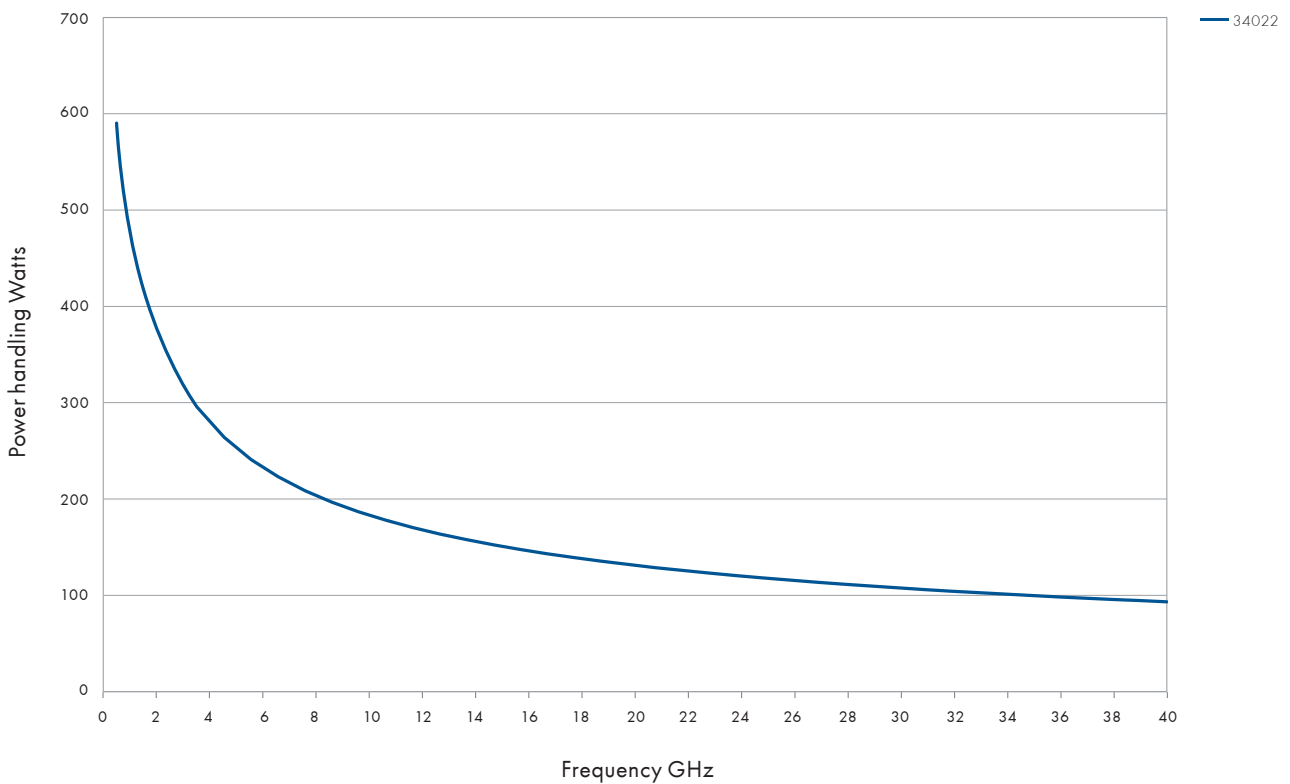

# Mini141

Mini141 is a superior alternative to custom length, predefined bend configuration semi-rigid cable. Mini141 has a microporous dielectric for low loss and improved phase stability. Mini141 has precision stainless steel SMA plug connectors on each end.

- Frequency range up to 26.5 GHz
- Precision stainless steel SMA plug connectors
- Automatically ruggedised by design



Length mm	Mini141	Item no.
127	mini141-5	80336857
152.4	mini141-6	80336872
177.8	mini141-7	80336884
203.2	mini141-8	80336896
228.6	mini141-9	80336905
254	mini141-10	80336790
279.4	mini141-11	80336793
304.8	mini141-12	80336797
330.2	mini141-13	80336802
355.6	mini141-14	80336804
381	mini141-15	80336807
406.4	mini141-16	80336810

# Mini141 K

Mini141 K is the 40 GHz version of the Mini141. Mini141 K replaces custom length, predefined bend configuration 0.141 inch Semi-rigid cable with truly flexible, low loss microporous dielectric, phase stable coax cable for use as interconnections between RF modules in microwave systems.

- Frequency range up to 40 GHz
- Precision stainless steel SK plug connectors
- Automatically ruggedised by design



Length mm	Mini141 K	Item no.
127	mini141 K-5	80336731
152.4	mini141 K-6	80336732
177.8	mini141 K-7	80336733
203.2	mini141 K-8	80336734
228.6	mini141 K-9	80336735
254	mini141 K-10	80336714
279.4	mini141 K-11	80362851
304.8	mini141 K-12	80336716
330.2	mini141 K-13	80336717
355.6	mini141 K-14	80336718
381	mini141 K-15	80362909
406.4	mini141 K-16	80336719

## Mini141 N

Mini141 N offers all of the features and benefits of the Mini141 but with N plug connections. Mini141 N replaces custom length, predefined bend configuration 0.141 inch semi-rigid cable with truly flexible, low loss, phase stable microporous dielectric coax cable in standard lengths.

- Frequency range up to 18 GHz
- Precision stainless steel N plug connectors
- Automatically ruggedised by design



Length mm	Mini141 N	Item no.
127	mini141 N-5	80336745
152.4	mini141 N-6	80336747
177.8	mini141 N-7	80365109
203.2	mini141 N-8	80336748
228.6	mini141 N-9	80366643
254	mini141 N-10	80363841
279.4	mini141 N-11	80362163
304.8	mini141 N-12	80336736
330.2	mini141 N-13	80366110
355.6	mini141 N-14	80336737
381	mini141 N-15	80361505
406.4	mini141 N-16	80336738

## Mini141 T

Mini141 T offers all of the features and benefits of the Mini141 but with ATNC plug connections. Mini141 T replaces custom length, predefined bend configuration 0.141 inch semi-rigid cable with truly flexible, low loss, phase stable microporous dielectric coax cable in standard lengths.

- Frequency range up to 18.5 GHz
- Precision stainless steel ATNC plug connectors compatible with TNC or TNC-A connectors per MIL-STD-348
- Automatically ruggedised by design



Length mm	Mini141 T	Item no.
127	mini141 T-5	80336751
152.4	mini141 T-6	80336752
177.8	mini141 T-7	80366192
203.2	mini141 T-8	80336753
228.6	mini141 T-9	80336912
254	mini141 T-10	80363433
279.4	mini141 T-11	80370800
304.8	mini141 T-12	80336911
330.2	mini141 T-13	80366954
355.6	mini141 T-14	80370801
381	mini141 T-15	80370802
406.4	mini141 T-16	80365426

# Mini141 W

Mini141 W is the "all weather" version of the Mini141 for environments with high humidity and moisture. Mini141 W meets moisture-resistance requirements of MIL-STD-202, method 106. Mini141 W replaces custom length predefined bend configuration 0.141 inch semi-rigid cable with truly flexible coax cable for use in external or internal point-to-point interconnections between modules in microwave systems.

- Frequency range up to 26.5 GHz
- Precision stainless steel SMA plug connectors
- Automatically ruggedised and weatherproof by design



Length mm	Mini141 W	Item no.
127	mini141 W-5	80336781
152.4	mini141 W-6	80336784
177.8	mini141 W-7	80362734
203.2	mini141 W-8	80336785
228.6	mini141 W-9	80336786
254	mini141 W-10	80336765
279.4	mini141 W-11	80336766
304.8	mini141 W-12	80336767
330.2	mini141 W-13	80336768
355.6	mini141 W-14	80336769
381	mini141 W-15	80362735
406.4	mini141 W-16	80336772



## Test leads for Test+Measurement set-ups

The best measurement set-up is only as good as its weakest link. To obtain reliable and reproducible measurement results, particular care must be taken in selecting the components required for the measurement set-up.

HUBER+SUHNER's extensive range of high quality test leads are matched to the various needs in the field of test and measurement. All these products are distinguished by their high performance and stable characteristics - the result of years of experience in the development and production of radio frequency components.



Sucotest 26/Sucotest 40

page 116

The test lead up to 26/40 GHz



Sucotest 18A

page 119

The test lead for harsh environment up to 18 GHz - precision at a constant high level

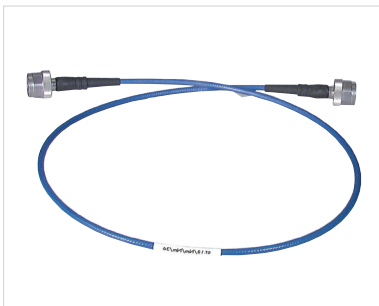

Sucotest 18

page 122

The test lead up to 18 GHz - for the highest standard of measurement



TL-8A

page 124

The test lead for component and equipment testing up to 8 GHz



TL-P

page 126

High flexible test lead for passive intermodulation (PIM) and return loss for frequency up to 4 GHz

# Sucotest 26/Sucotest 40

The test lead up to 26/40 GHz

## Product description

Sucotest 26/Sucotest 40 cable assemblies are high frequency, low loss cables which are five shielded for superior RF isolation. The internal stainless steel outer braid provides higher pull strength and lighter weight than RG style cable. Nomex and polyolefin jackets are also available.



## Product features

- Impedance 50 Ω
- Applicable up to 26/40 GHz
- Amplitude stability: < 0.1 dB at 26.5 GHz for 200 flexes  
180° in one plane around a 2" radius, 0.2 dB with 600 flexes
- Five shields for super RF shielding (-120 dB)
- Steel outer shield for high pull strength
- Low cost, available from stock

## Recommended connectors

ST26	SMA
ST40	SK

## Construction

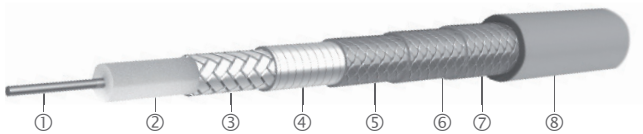

Cable	Inner conductor ①	Dielectric ②	Outer conductor ③	Barrier ④	Outer braid ⑤	Outer braid ⑥	Outer braid ⑦	Outer jacket ⑧	Outer diameter mm
Sucotest_26	CuAg wire	PTFE microporous	CuAg flat wire braid	aluminum/polyimide tape	stainless steel	CuAg	CuAg	FEP, blue	4.8
Sucotest_40									

## Technical data

Cable	Max. operating frequency	Velocity of propagation	Weight	Min. bending radii		Temperature range
	GHz			%	g/m	
Sucotest_26	26	76.3	62.5	17.8	53.3	-55 to +200
Sucotest_40	40	76.3	62.5	17.8	53.3	-55 to +200



# Sucotest 26/Sucotest 40

Attenuation (nominal values at +25 °C ambient temperature)

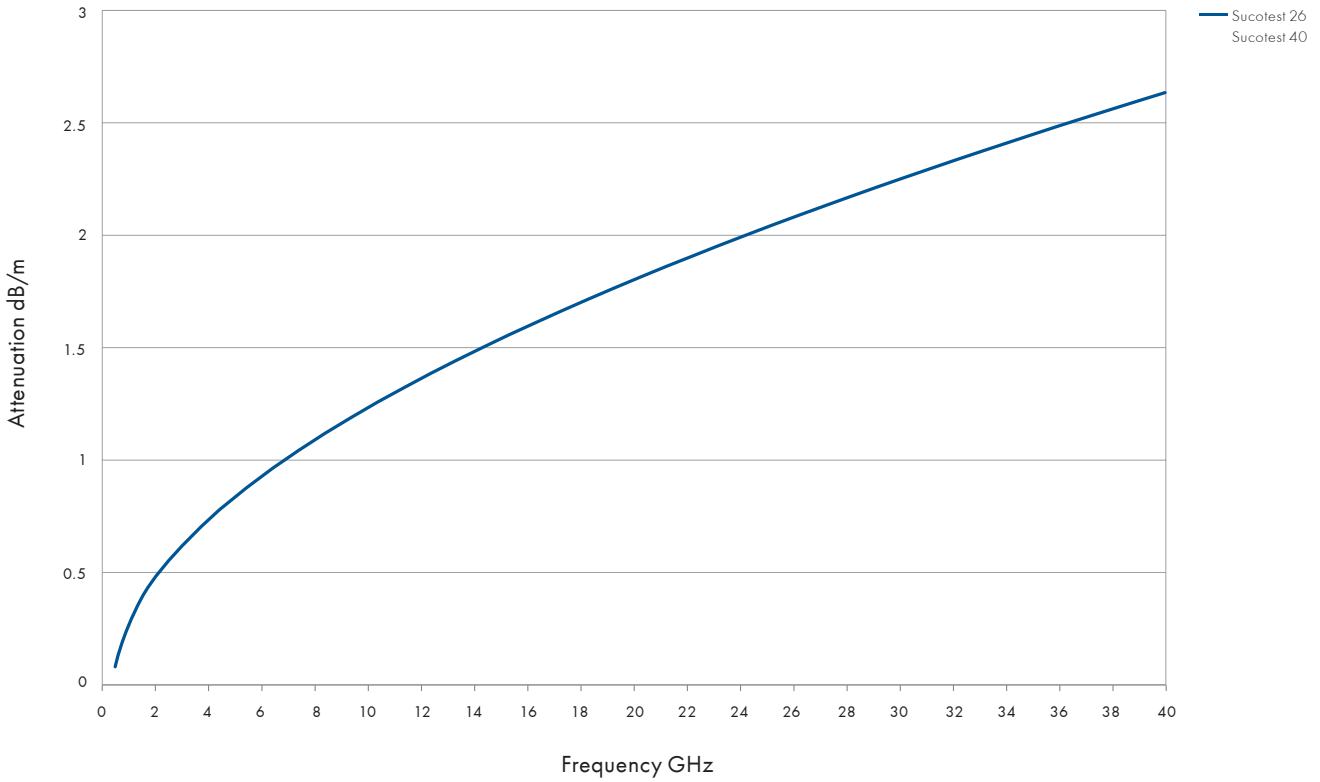

Power handling (maximum values at 25 °C ambient temperature and sea level)

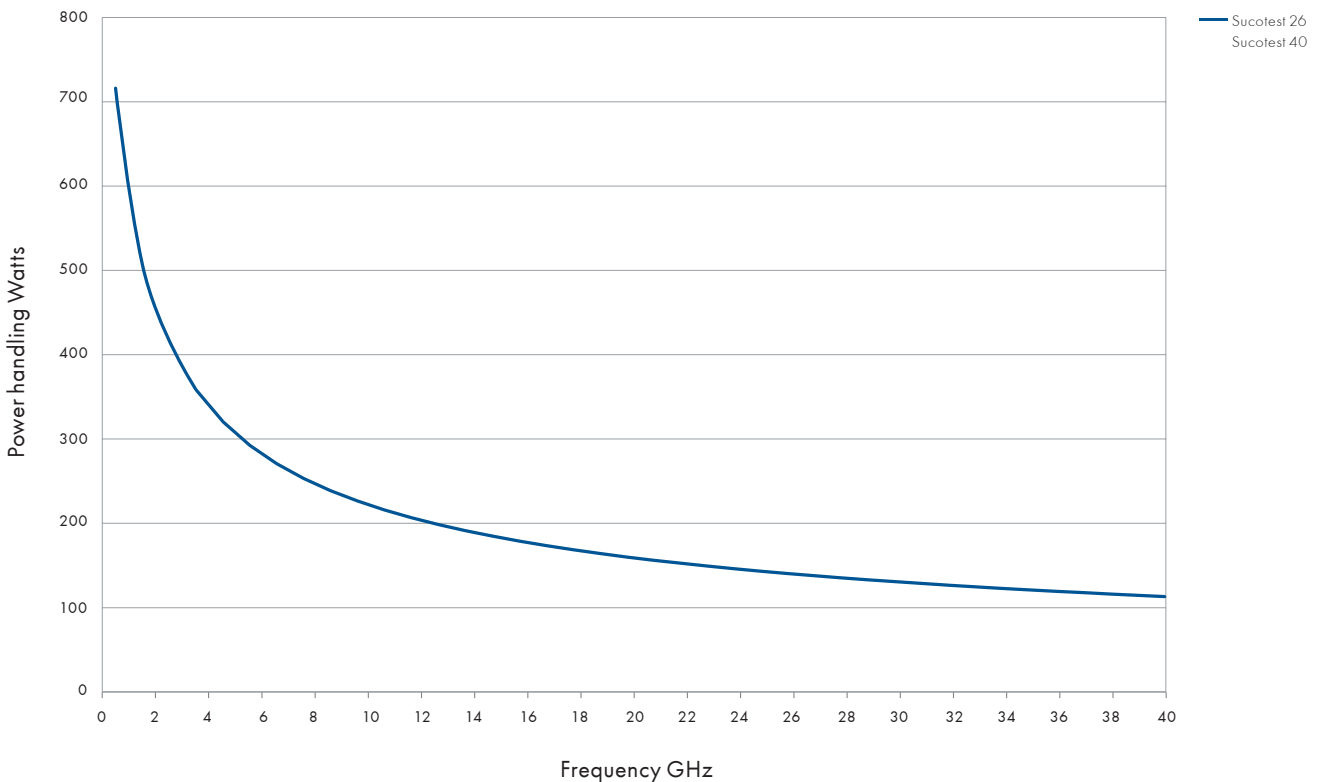

# Sucotest 26/Sucotest 40

## Available connectors

Connector	Series, pattern	HUBER+SUHNER type	Cable	Operating frequency
				GHz
SMA	straight cable plug	29094-32-26	ST26	26.5
	right angle 90° cable plug	29200-32-26		25
	straight cable jack	29092-32-26		25
SK	straight cable plug	29094K-32-26	ST40	40
	straight cable jack	29092K-32-26		40

## Stock assemblies

Item no.	Type	Length	Frequency	Max. insertion loss at 25 °C	Max. VSWR	RoHS compliant
		mm	GHz	dB		
80391541	ST26/SMAm/SMAm/24 inch	610	26.5	1.74	1.45	RoHS 5
80391542	ST26/SMAm/SMAm/36 inch	914	26.5	2.41	1.45	RoHS 5
80391543	ST26/SMAm/SMAm/48 inch	1219	26.5	3.08	1.45	RoHS 5
80391545	ST40/SKm/SKm/24 inch	610	40	2.20	1.50	RoHS 5
80391546	ST40/SKm/SKm/36 inch	914	40	3.03	1.50	RoHS 5
80391547	ST40/SKm/SKm/48 inch	1219	40	3.87	1.50	RoHS 5

# Sucotest 18A

The test lead for harsh environment up to 18 GHz – precision at a constant high level

## Product description

Sucotest 18A armoured test assemblies offer excellent electrical performance (low insertion loss combined with unique stability and excellent return loss) for heavy duty, outdoor and harsh environment measurements up to 18 GHz.

Sucotest 18A armoured test assemblies are ideal for testing wireless communication infrastructures, defense and ground systems and in daily use in components and assembly shops.



Test assemblies

## Product features

- Impedance 50 Ω
- Applicable up to 18 GHz
- High flexibility in spite of armoring
- Phase and loss stability with flexure
- Crush-, torque- and kink-resistant
- Waterproof IP68

## Recommended connectors

ST_18A	N, 7/16
--------	---------

## Construction

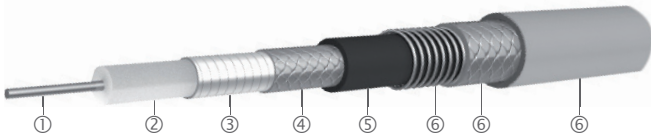

Cable	Inner conductor ①	Dielectric ②	Outer conductor ③ ④	Jacket ⑤	Ruggedisation ⑥	Outer diameter mm
Sucotest_18A	CuAg strand	LD-PTFE	CuAg tape CuSn braid	FEP	stainless steel/PUR, blue	10.3

## Technical data

Cable	Operating frequency GHz	Velocity of propagation %	Weight g/m	Min. bending radius for ± 180° mm	Temperature range °C
Sucotest_18A	18	77	175.0	50.0	-40 to +85

## Available connectors

Connector	Series, pattern	HUBER+SUHNER type	Cable	Operating frequency GHz	VSWR per connector
7/16	straight cable plug	11_716-403	ST_18A	7.5	1.14
	straight cable jack	21_716-403		7.5	1.14
N	straight cable plug	11_N-468		18	1.14
	straight cable jack	21_N-409		18	1.14

# Sucotest 18A

## Assemblies data

		up to 2 GHz	2 - 4 GHz	4 - 6 GHz	6 - 7.5 GHz	7.5 - 12 GHz	12 - 18 GHz			
Insertion loss stability **		< 0.03 dB	< 0.04 dB	< 0.04 dB	< 0.04 dB	< 0.05 dB	< 0.05 dB			
Phase stability **		± 2° el	± 4° el	± 4° el	± 6° el	± 6° el	± 6° el			
Min. return loss *** ≤ 3000 mm	N-N	> 30 dB	> 28 dB	> 25 dB	> 21 dB	> 21 dB	> 19 dB			
	N-7/16	> 21 dB	> 18 dB	> 18 dB	> 18 dB					
Min. return loss *** > 3000 mm	N-N	> 19 dB	> 19 dB	> 19 dB	> 19 dB	> 19 dB	> 19 dB			
	N-7/16	> 18 dB	> 18 dB	> 18 dB	> 18 dB					
Max. insertion loss at +25 °C	assembly length		f (GHz)	1	2	4	6	7.5	12	18
	1500 mm		dB	0.55	0.80	1.16	1.45	1.65	2.16	2.74
	3000 mm		dB	1.06	1.53	2.24	2.80	3.18	4.17	5.30

## Mechanical specifications

Mechanical specifications	
Waterproof	IP68
Flex life (cycles)	100 000
Connector retention force	> 230 N

## Stock assemblies

Item no.	Type	Length mm	Frequency GHz	Max. insertion los at 25 °C	Max. VSWR	ROHS compliant
84013029	ST18A/Nm/Nm/1500 mm*	1500	18	2.74	1.25	yes
84013030	ST18A/Nm/Nf/1500 mm*	1500	18	2.74	1.25	yes
84013031	ST18A/Nm/Nm/3000 mm*	3000	18	5.30	1.25	yes
84013032	ST18A/Nm/Nf/3000 mm*	3000	18	5.30	1.25	yes

\* Available from stock.

\*\* One wrap (360°) around a 50 mm (2.0")

\*\*\* Return loss of on stock assemblies, for customised lengths and configurations please contact HUBER+SUHNER.

# Sucotest 18A

Attenuation (nominal values at +25 °C ambient temperature)

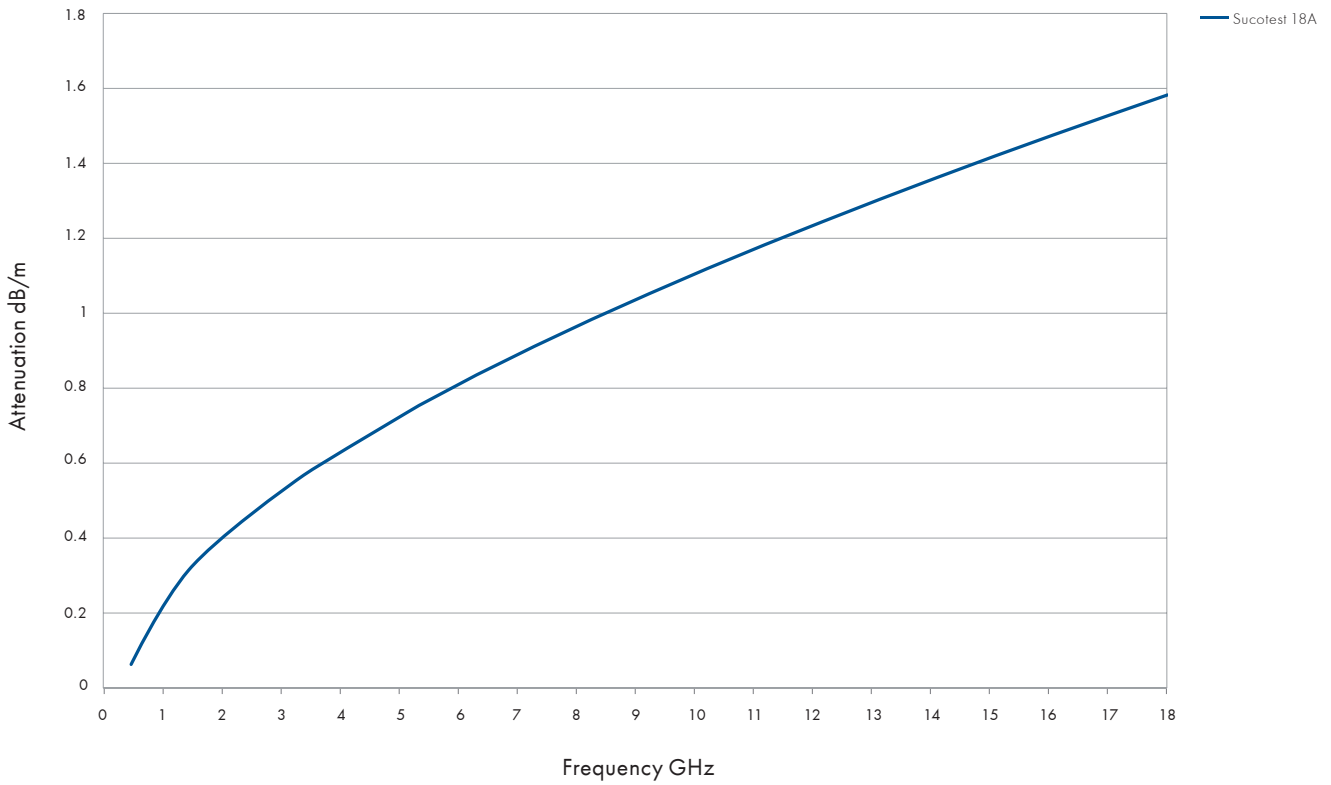

Power handling (maximum values at 25 °C ambient temperature and sea level)

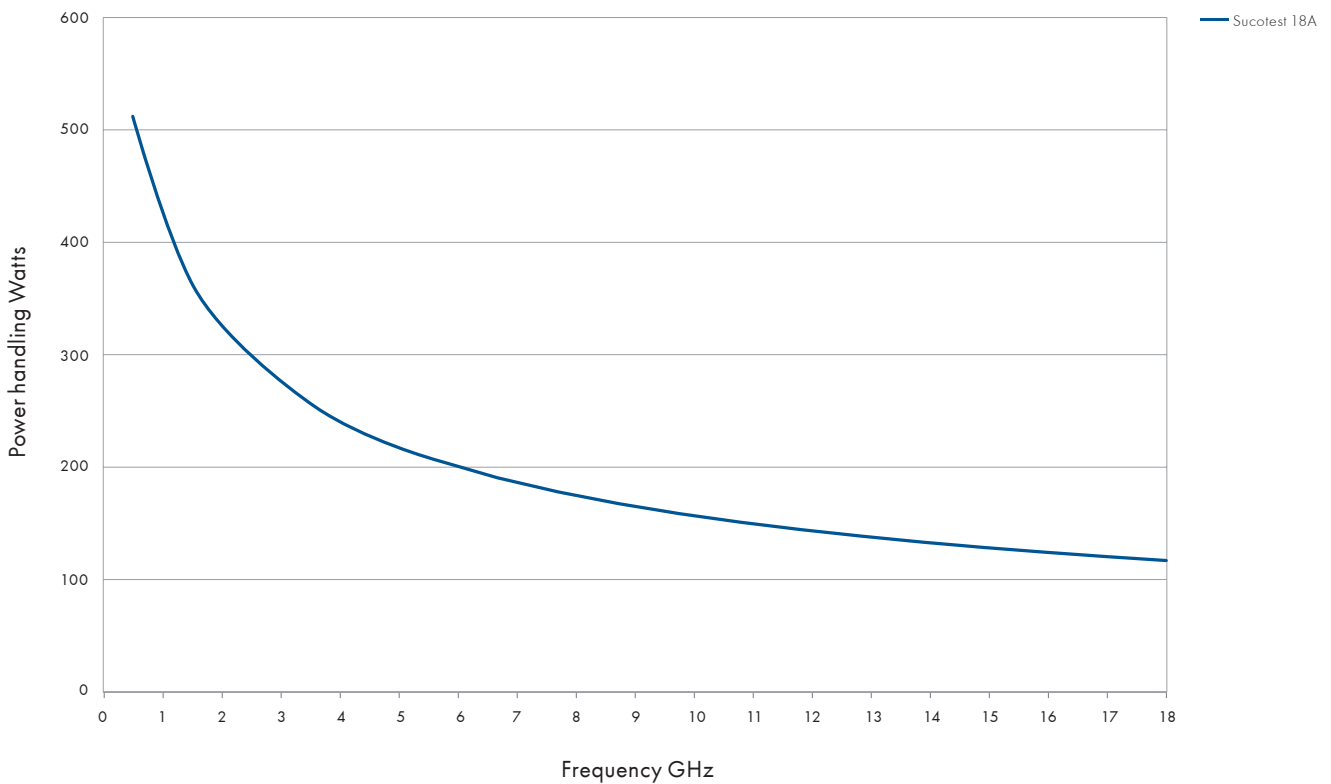

# Sucotest 18

The test lead up to 18 GHz - for the highest standard of measurement

## Product description

Sucotest 18 cable assemblies feature excellent electrical performance (low insertion loss combined with unique loss stability and excellent return loss).

Sucotest 18 is ideal for daily use in components and assembly shops, test labs and automatic test equipment applications.

## Product features

- Impedance 50 Ω
- Applicable up to 18 GHz
- Low insertion loss
- Excellent VSWR
- Unique loss stability
- There is no cable spring back during measurement procedures; the assembly stays in position.

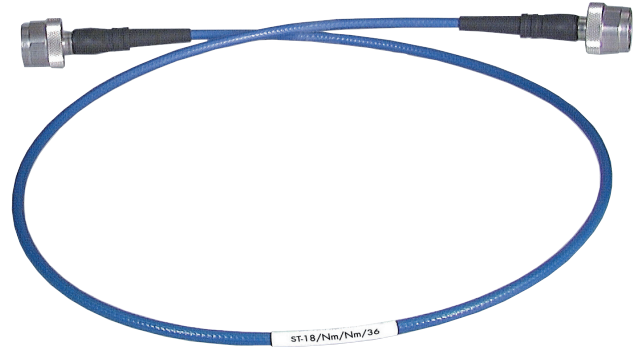

## Recommended connectors

ST_18	SMA, QMA, N
-------	-------------

## Construction

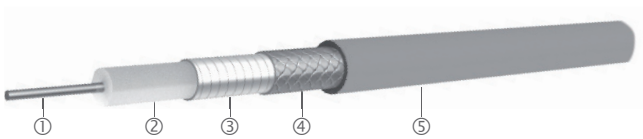

Cable	Inner conductor ①	Dielectric ②	Outer conductor ③ ④	Jacket ⑤	Outer diameter mm
Sucotest_18	CuAg wire	LD-PTFE	CuAg tape CuSn braid	FEP, blue	4.6

## Technical data

Cable	Operating frequency	Velocity of propagation	Weight	Preferred bending radius	Temperature range
	GHz	%	g/m	mm	°C
Sucotest_18	18	77	53.0	100.0	-55 to +105

# Sucotest 18

## Specifications

Frequency range	2 GHz	2.01 - 4 GHz	4.01 - 6 GHz	6.01 - 12 GHz	12.01 - 18 GHz
Power handling 25 °C, sea level (W)	> 391	> 277	> 225	> 160	> 131
Return loss (dB)	> 30	>28	> 25	> 21	> 19
Insertion loss stability vs. shaking (dB)	< 0.03	< 0.03	< 0.03	< 0.03	< 0.03
Insertion loss stability vs. bending (dB)	< 0.03	< 0.04	< 0.04	< 0.05	< 0.05
Insertion loss stability vs. torsion (dB)	< 0.03	< 0.04	< 0.04	< 0.05	< 0.05

## Stock assemblies

HUBER+SUHNER cable type	Item no.	Assembly length (ref. - ref.) mm/in	Weight gram	Insertion loss dB				
				up to 2 GHz	2.01 - 4 GHz	4.01 - 6 GHz	6.01 - 12 GHz	12.01 - 18 GHz
ST-18/SMAm/SMAm/36 inch	84002061	914/36	68	< 0.48	< 0.68	< 0.84	< 1.21	< 1.51
ST-18/Nm/Nm/36 inch	84002060	914/36	110	< 0.48	< 0.68	< 0.84	< 1.21	< 1.51
ST-18/SMAm/Nm/36 inch	84004594	914/36	90	< 0.48	< 0.68	< 0.84	< 1.21	< 1.51
ST-18/SMAm/SMAm/48 inch	84003373	1219/48	80	< 0.61	< 0.88	< 1.09	< 1.57	< 1.95
ST-18/Nm/Nm/48 inch	84003372	1219/48	122	< 0.61	< 0.88	< 1.09	< 1.57	< 1.95
ST-18/SMAm/Nm/48 inch	84004006	1219/48	101	< 0.61	< 0.88	< 1.09	< 1.57	< 1.95
ST-18/SMAm/SMAm/72 inch	84004007	1829/72	108	< 0.89	< 1.28	< 1.58	< 2.29	< 2.85
ST-18/Nm/Nm/72 inch	84004070	1829/72	157	< 0.89	< 1.28	< 1.58	< 2.29	< 2.85
ST-18/SMAm/Nm/72 inch	84004595	1829/72	134	< 0.89	< 1.28	< 1.58	< 2.29	< 2.85

Other lengths on request with minimum order quantity of 50 pcs.

# TL-8A

The test lead for component and equipment testing up to 8 GHz

## Product description

TL-8A assemblies are designed for testing components or equipments up to 8 GHz with network analyser (NA). This economical assembly family is made with a PE foamed double screened cable and protected with an armouring using a moulded cable entry. The excellent electrical performance combined with a high mechanical endurance is ideal for use in test labs and in operations



## Product features

- Impedance 50 Ω
- Applicable up to 8 GHz
- High mechanical endurance
- Excellent insertion and return loss
- High mating cycle
- N connector with quick-lock nut
- Excellent performance to price ratio
- Free of halogen

## Recommended connectors

TL-8A	SMA, N
	Other connectors available on request.

## Construction

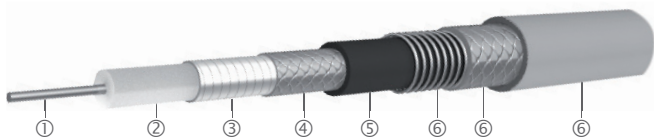

Cable	Inner conductor ①	Dielectric ②	Outer conductor ③④	Jacket ⑤	Ruggedisation ⑥	Outer diameter
						mm
TL-8A	CuAg wire	SPE	CuAg braid	LSFH	stainless steel/PUR, blue	10.3

## Technical data

Cable	Operating frequency	Velocity of propagation	Weight	Preferred bending radius	Temperature range
	GHz	%	g/m	mm	°C
TL-8A	8	82	225.0	100.0	-5 to +85



# TL-8A - ... -51

## Technical data

Key values						
Frequency	up to 8 GHz					
Return loss	1 GHz	2 GHz	4 GHz	6 GHz	8 GHz	
	up to 1 m	≤ -30 dB	≤ -27 dB	≤ -25 dB	≤ -23 dB	≤ -21 dB
	≥ 3.0 m	≤ -29 dB	≤ -26 dB	≤ -24 dB	≤ -22 dB	≤ -20 dB
Attenuation	1.24 dB/m at 8 GHz (typical)					
Waterproof	no gasket on interface					
Durability (matings)	> 3000 cycles					
Assembly length	min. 300 mm, max. 3000 mm					

## Stock assemblies

Item no.	Type	Length mm	Frequency GHz	Max. insertion los at 25 °C	Max. VSWR	ROHS compliant
85006682	TL-8A-11N-11N-01500-51	1500	8	1.84	1.20	yes
85014643	TL-8A-11N-11SMA-01500-51	1500	8	1.84	1.18	yes
85021664	TL-8A-11N-21N-01500-51	1500	8	1.84	1.20	yes

Available in predetermined lengths	
TL-8A-11N-11N-xxxxx*-51	0.6 m up to 3.0 m
TL-8A-11N-11SMA-xxxxx*-51	
TL-8A-11SMA-11SMA-xxxxx*-51	
TL-8A-11N-21N-xxxxx-51	

## TL - 8A - 11 N - 11 SMA - 01500 - 51

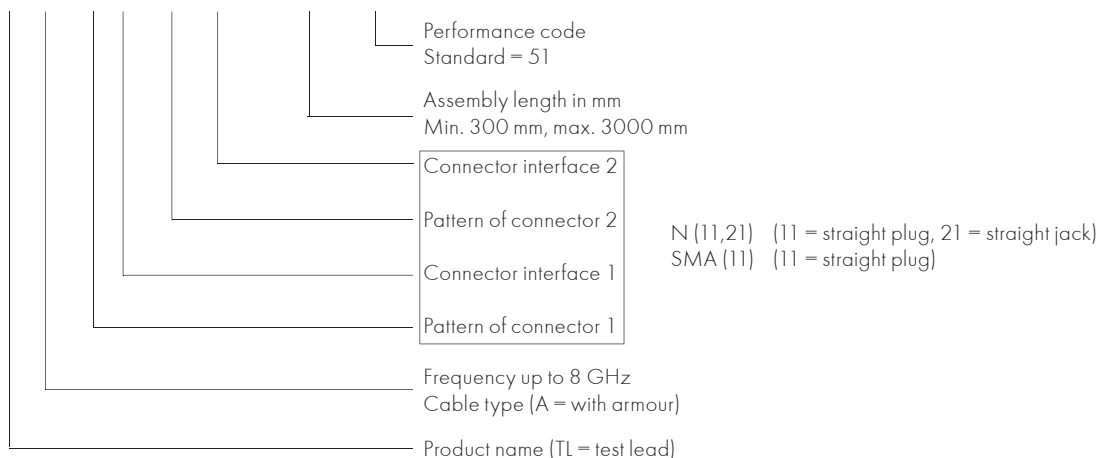

\* Length of assembly in mm; length up to four meters on request.

# TL-P

High flexible test lead for passive intermodulation (PIM) and return loss for frequency up to 4 GHz

## Product description

HUBER+SUHNER TL-P assemblies are designed for indoor and outdoor applications where passive intermodulation (PIM) has to be tested.

This assembly family is based on a flexible cable which is optimised up to 4 GHz and protected with a steel armouring. The robust design is completed with a molded protection between connector and cable.

## Product features

- Impedance 50 Ω
- Applicable up to 4 GHz
- Excellent PIM performance ( $\leq -160$  dBc)
- High mechanical endurance
- Return Loss performance
- High mating cycle (> 2000)
- Highly flexible, rugged and reliable design
- Easy to handle for work in field
- Excellent performance to price ratio



## Recommended connectors

TL-P	7/16, N, 4.3-10 (screw version)
	Other connectors available on request.

## Construction

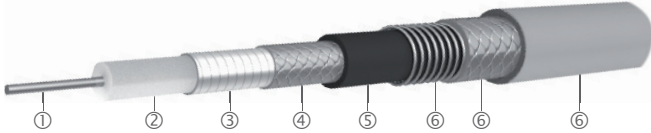

Cable	Inner conductor ①	Dielectric ②	Outer conductor ③ ④	Jacket ⑤	Ruggedisation ⑥	Outer diameter mm
TL-P	CuAg wire	PTFE	CuAg braid	FEP	stainless steel/PUR, blue	10.3

## Technical data

Cable	Operating frequency GHz	Velocity of propagation %	Weight g/m	Preferred bending radius mm	Temperature range °C
TL-P	4	71	150.0	110.0	-15 to +65

## Available connectors

Connector	Series, pattern	Code	Operating frequency GHz
7/16	straight cable plug	7/16	4
N	straight cable plug	N	4
4.3-10 (screwed)	straight cable plug	431X	4

# TL-P - ... -51

## Technical data

Key values				
Frequency	up to 4 GHz			
Return loss (up to length = 3.0 m)	1 GHz	2 GHz	3 GHz	4 GHz
	≤ -29 dB	≤ -26 dB	≤ -23 dB	≤ -20 dB
Power (at 40 °C, sea level)	≤ 560 W	≤ 390 W	≤ 320 W	≤ 280 W
Attenuation (at 25 °C)	0.75 dB/m at 2 GHz, 0.90 dB/m at 3 GHz			
PIM	≥ -117 dBm (160 dBc), tested according IEC 62037-2			
Waterproof	IP67			
Shielding effectiveness	> -120 dB			
Temperature range	-15 to +65 °C (operating) -10 to +55 °C (installation)			
Durability (matings)	> 2000 cycles			
Bending radius repeated	min. 50 mm (1.5 ×)			
Bending radius dynamic	≥ 110 mm (4.3 in), flex-life 10 000 bendings ± 90°			

## Stock assemblies

Item no.	Type	Length mm	Frequency GHz	Max. insertion loss at 25 °C	Max. VSWR	Min. PIM dBc	ROHS compliant
85017448	TL-P-11716-11716-01500-51	1500	4	1.54	1.22	160	yes
85027254	TL-P-11716-11716-03000-51	3000	4	2.97	1.22	160	yes
85027450	TL-P-11716-11N-01500-51	1500	4	1.54	1.22	160	yes
85027453	TL-P-11716-11N-03000-51	3000	4	2.97	1.22	160	yes
85029279	TL-P-11431X-11716-01500-51	1500	4	1.54	1.22	160	yes
85029280	TL-P-11431X-11716-03000-51	3000	4	2.97	1.22	160	yes

## TL - P - 11 431X - 11 716 - 01500 - 51

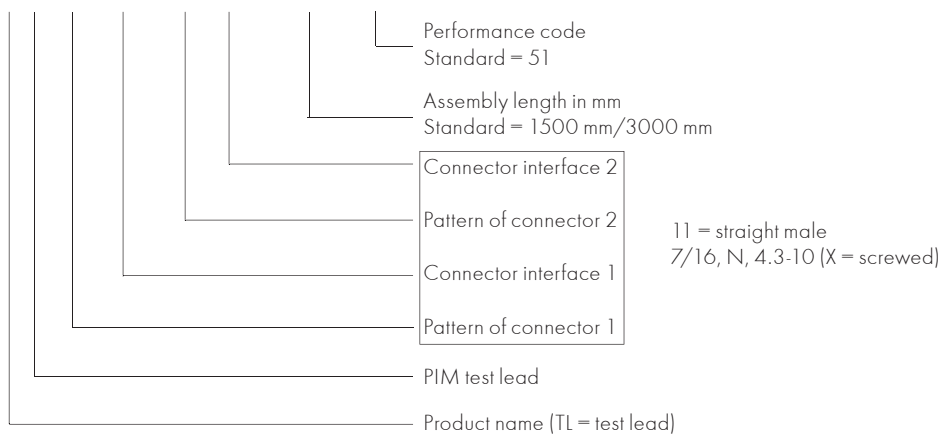



## Flexible microwave cable assemblies

HUBER+SUHNER develops and produces coaxial cables for a wide range of applications all over the world according to international standards. Many years of experience and in-house manufacturing combine to produce a portfolio of components adapted perfectly to one another. Continuous further development ensures that the products are perfectly aligned with market requirements and incorporate the latest technology. An innovative development department with in-house test laboratories can react quickly to changing market trends and even develop customer-specific solutions.



### Boa-flex I

page 132

Low loss, phase stable coaxial cables/cable assemblies

- Frequency range up to 26 GHz
- Triple shielded for high isolation
- Low density PTFE
- Excellent phase stability



### Steel-flex II

page 136

Low loss, phase stable coaxial cables/cable assemblies

- Frequency range up to 110 GHz
- Steel outer shield for high pull strength
- Low density PTFE
- Excellent phase stability



### Steel-flex I

page 140

High performance, high pull strength microwave coaxial cables/cable assemblies

- Frequency range up to 85 GHz
- Steel outer shield for high pull strength
- Designed for low cost/high volume applications
- Excellent phase stability



### Multiflex 86/141

page 144

The flexible alternative to semi-rigid

- Frequency range up to 67 GHz
- High screening
- High flexibility
- Resistant to chemicals, oils, lubricants, humidity



### S-series

page 148

The economical, low loss microwave cables/cable assemblies

- Frequency range up to 18 GHz
- Low insertion loss
- Excellent screening effectiveness
- Low smoke, halogen free version available

# High flexible microwave cable assemblies



## Ever-flex

page 151

The high flexibility microwave coaxial cables/cable assemblies

- Frequency range up to 40 GHz
- High reliability
- Light weight
- Low loss
- 1 000 000 flex cycles



## Multiflex 53-02

page 153

The highly flexible microwave coaxial cable assemblies

- Frequency range up to 67 GHz
- Thin and ultra-stable
- 50 000 flex cycles



## Boa-flex III

page 155

MIL-C-17 replacement coaxial cables/cable assemblies

- Frequency range up to 12 GHz
- Solid Teflon® dielectric
- Low loss MIL-C-17 replacements
- Operating temperature  $-55$  to  $+200$  °C

# High power microwave cable assemblies



## Boa-flex II

The high power, low loss microwave coaxial cables/cable assemblies

- Frequency range up to 14 GHz
- Low density PTFE
- Exceptional phase stability
- Excellent phase versus temperature characteristics

page 157

# Field terminated microwave cable assemblies



## Eacon

The field terminated microwave cables/cable assemblies

- Frequency range up to 18 GHz
- Waterproof IP67
- Extremely reliable
- Easy assembling - only two connector parts

page 159

# Boa-flex I

The low loss, flat wire braid microwave coaxial cables

## Product description

Boa-flex I cables utilise a microporous PTFE dielectric for low loss with minimal phase change due to temperature changes and flexure. Typical velocity is 77 % of the speed of light. Construction consists of a flat wire braid outer conductor, a metalised polyimide intra-layer, and a round wire braid to complete the triple shielded construction. All offer very low loss and are extremely stable with flexure.



## Product features

- Impedance 50 Ω
- Applicable up to 26 GHz
- Low density PTFE for superior electrical performance
- Triple shielded construction
- Excellent phase and IL stability with flexure
- Excellent phase versus temperature characteristics
- Phase matching and phase tracking applications

## Recommended connectors

32055	SMA, TNC, N, SC, 3.5 mm
32051	SMA, TNC, N, SC

## Construction

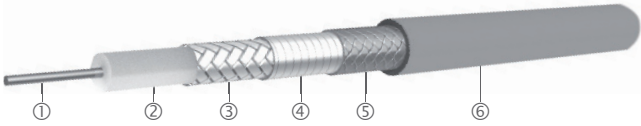

32055, 32051

Cable	Inner conductor ①	Dielectric ②	Outer conductor ③	Barrier ④	Outer braid ⑤	Jacket ⑥	Outer diameter mm
32055	CuAg wire	PTFE microporous	CuAg flat wire braid	polyimide/ aluminium tape	CuAg	FEP, clear	5.5
32051	CuAg wire	PTFE microporous	CuAg flat wire braid	polyimide/ aluminium tape	CuAg	FEP, amber	7.8



# Boa-flex I

The low loss, flat wire braid microwave coaxial cables

## Construction

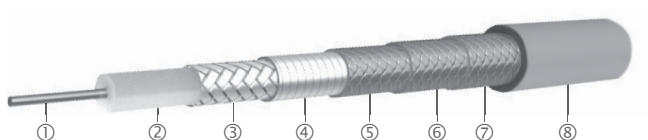

## Technical data

Cable	Item no.	Max. operating frequency	Velocity of propagation	Weight	Min. bending radii		Temperature range
		GHz	%		static mm	repeated mm	
32055	80310948	26	77.3	64.0	22.9	68.6	-55 to +200
32051	80310945	18	77.8	114.6	34.3	102.9	

# Boa-flex I

Attenuation (nominal values at +25 °C ambient temperature)

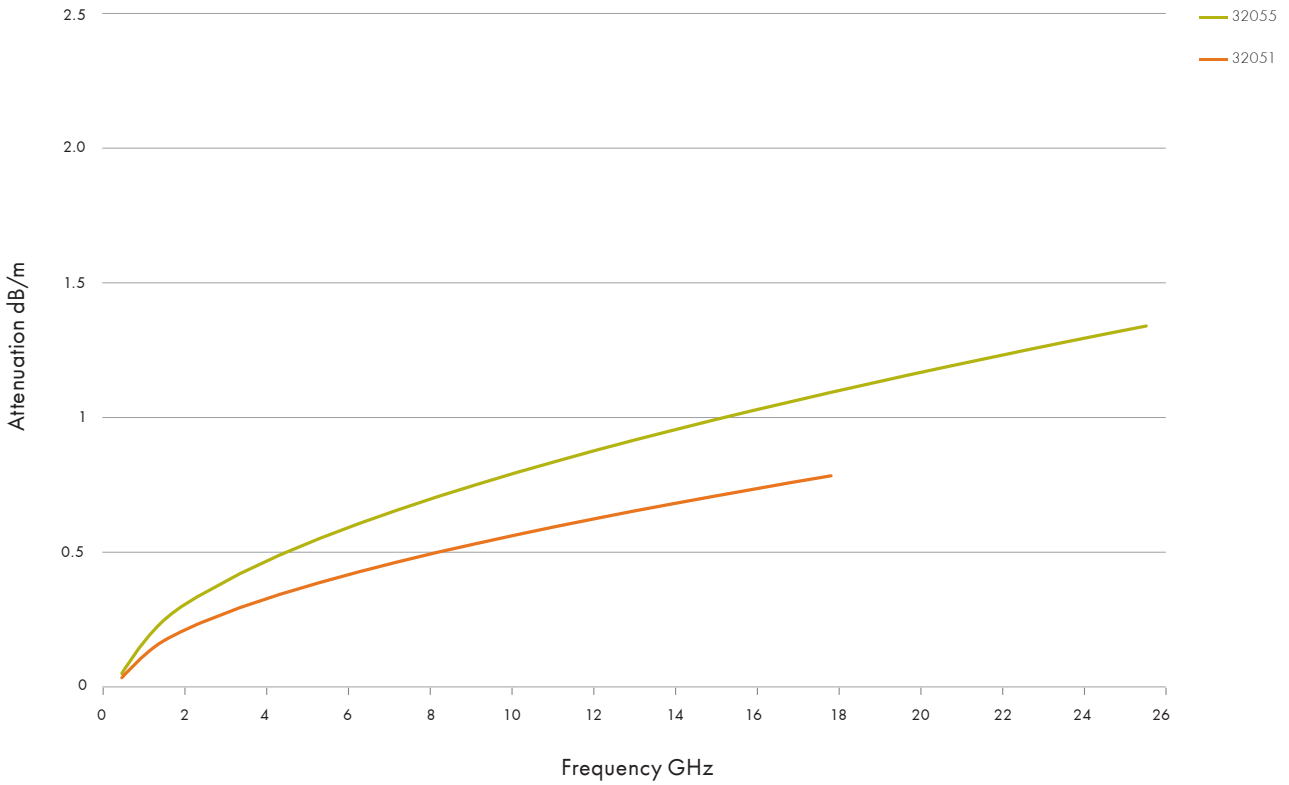

Power handling (maximum values at 25 °C ambient temperature and sea level)

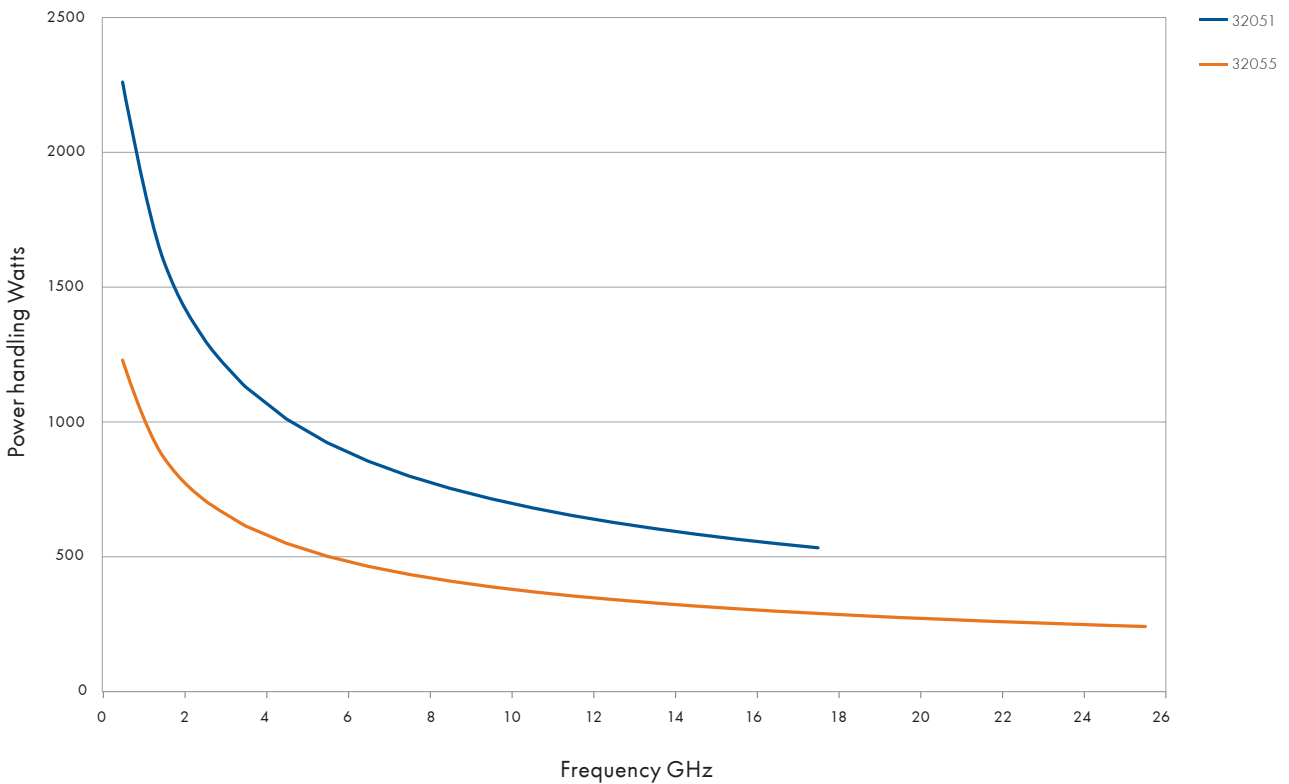

# Boa-flex I

## Available connectors

Connector	Series, pattern	HUBER+SUHNER type	Cable	Operating frequency GHz	Item no.
SMA	straight cable plug	29094-32-55	32055	26	80316322
	right angle 90° cable plug	29200-32-55		25	80316978
	straight cable jack	29092-32-55		26	80316175
	straight flanged cable jack	29142-32-55		26	80340386
	straight cable plug	29094-32-51	32051	18	80316317
	straight cable jack	29092-32-51		18	80316174
N	straight cable plug	29080-32-55	32055	18	80315873
	straight cable jack	29081P-32-55		18	80315973
	90° sweep cable plug	29741-32-55		18	80319551
	straight cable plug	29080-32-51	32051	18	80315869
	straight cable jack	29081P-32-51		18	80315972
	90° sweep cable plug	29741-32-51		18	80319549
TNC	straight cable plug	29714-32-55	32055	18	80319160
	90° sweep cable plug	29738-32-55		18	80340685
	straight bulkhead cable jack	29320-32-55		15	80317445
	straight cable plug	29714-32-51	32051	18	80319159
	90° sweep precision cable plug	29738-32-51		18	80319501
SC	straight cable plug	29642-32-51	32051	10.0	80318825
	straight cable plug	29642-32-55	32055	10.0	80340625

# Steel-flex II

Low loss, phase stable coaxial cables

## Product description

Steel-flex II cables are designed as low loss alternative to steel-flex I cable. The microporous dielectric provides improved phase characteristics, such as phase versus flexure and phase versus temperature.

## Product features

- Impedance 50 Ω
- Applicable up to 45 GHz
- Steel outer shield for high pull strength
- Low density PTFE for superior electrical performance
- Excellent phase and IL stability with flexure
- Excellent phase versus temperature characteristics
- Phase matching and phase tracking applications



## Recommended connectors

32022	SMA, TNC, N, SK, 3.5 mm, SMP
32024	SMA, SMP, TNC, BMA, SMPM-T
32026	SMA, SK
32094	SMA, N, TNC, 3.5 mm
32021	SMA

## Construction

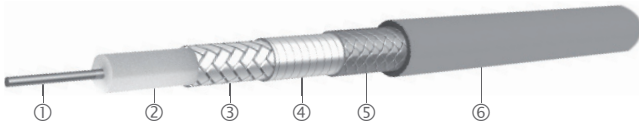

32022, 32024

Cable	Inner conductor ①	Dielectric ②	Outer conductor ③	Barrier ④	Outer braid ⑤	Jacket ⑥	Outer diameter mm
32022	CuAg wire	PTFE microporous	CuAg flat wire braid	polyimide/ aluminium tape	stainless steel	FEP, clear	3.7
32024	CuAg wire	PTFE microporous	CuAg flat wire braid	polyimide/ aluminium tape	stainless steel	FEP, clear	2.7

# Steel-flex II

## Construction

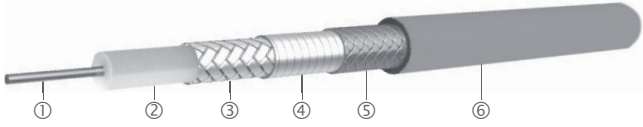

32094

Cable	Inner conductor ①	Dielectric ②	Outer conductor ③	Barrier ④	Outer braid ⑤	Jacket ⑥	Outer diameter
							mm
32094	CuAg strand	PTFE microporous	CuAg flat wire braid	polyimide / aluminium tape	stainless steel	FEP, clear	5.5

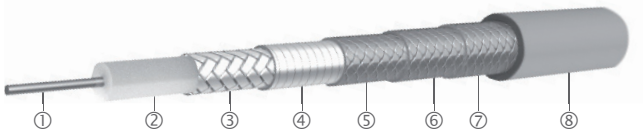

32021, 32026

Cable	Inner conductor ①	Dielectric ②	Outer conductor ③	Barrier ④	1. Outer braid ⑤	2. Outer braid ⑥	3. Outer braid ⑦	Jacket ⑧	Outer diameter
									mm
32021	CuAg wire	PTFE microporous	CuAg flat wire braid	polyimide/ aluminium tape	stainless steel	CuAg	CuAg	FEP, blue	3.7
32026	CuAg wire	PTFE microporous	CuAg flat wire braid	polyimide/ aluminium tape	stainless steel	CuAg	CuAg	FEP, blue	4.9

## Technical data

Cable	Item no.	Max. operating frequency	Velocity of propagation	Weight	Min. bending radii		Temperature range
		GHz	%		static mm	repeated mm	
32021	80310919	45	76.5	40.2	8.4	25.1	
32022	80310920	40	76.3	31.3	8.4	25.1	
32024	80310922	40	76.5	16.4	6.4	19.1	
32026	80310924	40	76.3	62.5	17.8	53.3	
32094	80310965	26	77	61.0	22.8	68.6	

# Steel-flex II

Attenuation (nominal values at +25 °C ambient temperature)

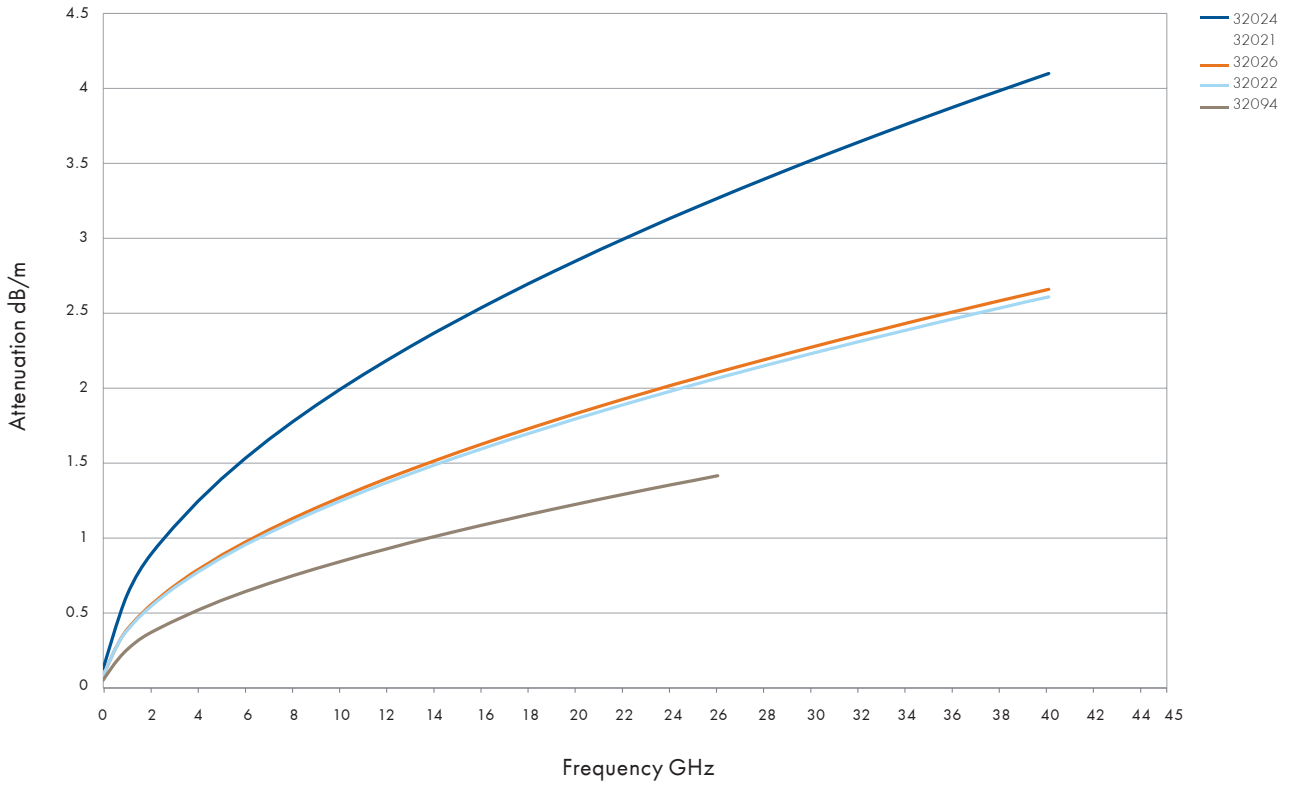

Power handling (maximum values at 25 °C ambient temperature and sea level)

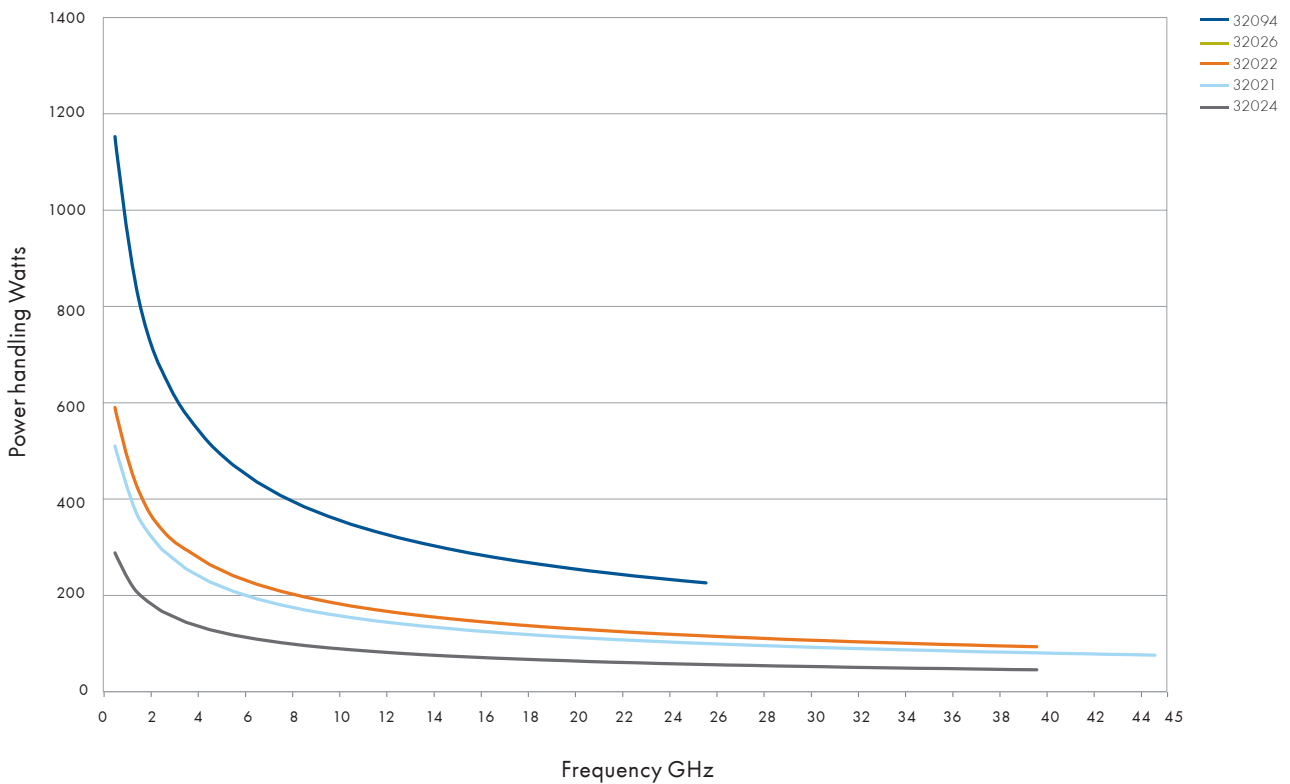

# Steel-flex II

## Available connectors

Connector	Series, pattern	HUBER+SUHNER type	Cable	Operating frequency GHz	Item no.
SMA	straight cable plug	29094CR-32-61	32021	26.5	80363604
	straight cable plug	29094-32-22	32022	26.5	80316285
	straight cable jack	29092-32-22		25	80316163
	straight cable plug	29094-32-24	32024	26.5	80316292
	straight cable plug	29094-32-26	32026	26.5	80367528
	straight cable jack	29092-32-26		25	80376268
	straight cable plug	29094-32-94	32094	26.5	80316331
	straight cable jack	29092-32-94		25	80316179
	straight cable plug	29094CR-32-61	32061	26.5	80340299
SMP	straight cable jack	29473CR-32-24	32024	40	80340518
	straight cable jack	29473CR-32-22	32022	40	80340517
SK	straight cable plug	29094K-32-22	32022	40	80316376
	straight cable jack	29092K-32-22		40	80316201
	straight cable plug	29094K-32-26	32026	40	80340320
	straight cable jack	29092K-32-26		40	80369355
TNC	straight cable plug	29714-32-22	32022	18	80319137
	straight bulkhead cable jack	29320-32-22		18	80317435
	straight cable plug	29714-32-94TC	32094	18	80367102
	straight cable plug	29714-32-24	32024	12	80319143
N	straight cable plug	29080-32-22	32022	18	80315843
	straight cable jack	29081P-32-22		18	80340158
	straight bulkhead cable jack	29082-32-22		18	80315991
	straight cable plug	29080-32-94	32094	18	80315883
3.5 mm	straight cable plug	29801-32-22	32022	36	80319727
	straight cable tonight	29800-32-22		36	80319706
	straight cable plug	29801-32-94	32094	26.5	80319739
BMA	straight bulkhead cable plug	29905CR-32-24	32024	26	80319983
SMPM-T	straight cable jack	29971TCR-32-24	32024	50	80395423

# Steel-flex I

High performance, high pull strength microwave coaxial cables

## Product description

Steel-flex cables are lightweight flexible replacements to semi-rigid cable. All utilise triple shields for superior RF shielding, with a solid TFE dielectric for exceptional crush resistance without the need for heavy armor. The flat wire braid outer conductor provides low loss plus excellent insertion loss stability with flexure. The stainless steel outer braid provides improved mechanical pull strength when compared to cables with a copper wire outer braid.



## Product features

- Impedance 50 Ω
- Applicable up to 85 GHz
- Designed for low cost/high volume applications
- Excellent loss stability over flexure
- Steel outer shield for high pull strength
- UL approved

## Recommended connectors

32041	SMPM, SMPM-T, BMA, SMP
32061	SMA, 1 mm
32081	SMA, N, SSMA, TNC, SMP
32086	SMA
32091	SMA, SMK

## Construction

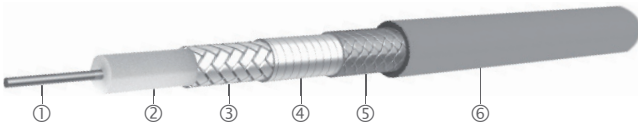

32041, 32081, 32086, 32061

Cable	Inner conductor ①	Dielectric ②	Outer conductor ③	Barrier ④	Outer braid ⑤	Jacket ⑥	Outer diameter mm
32041	CuAg wire	PTFE	CuAg flat wire braid	polyimide/ aluminium tape	stainless steel	FEP, green	2.0
32061	CuAg wire	PTFE	CuAg flat wire braid	polyimide/ aluminium tape	stainless steel	FEP, grey	1.6
32081	CuAg wire	PTFE	CuAg flat wire braid	polyimide/ aluminium tape	stainless steel	FEP, blue	2.6
32086	CuAg strand	PTFE	CuAg flat wire braid	PTFE tape	stainless steel	FEP, clear	2.7



# Steel-flex I

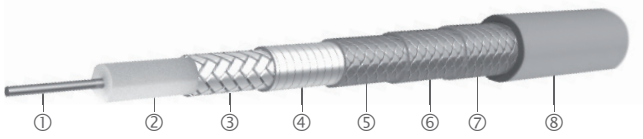

32091

Cable	Inner conductor ①	Dielectric ②	Outer conductor ③	Barrier ④	1. Outer braid ⑤	2. Outer braid ⑥	3. Outer braid ⑦	Jacket ⑧	Outer diameter
									mm
32091	CuAg wire	PFTF	CuAg flat wire braid	polyimide/ aluminium tape	stainless steel	StCuAg	StCuAg	FEP, blue	2.6

## Technical data

Cable	Item no.	Max. operating frequency	Velocity of propagation	Weight	Min. bending radius		Temperature range
		GHz	%		static mm	repeated mm	
32041	80310936	85	70.0	11.9	1.5	4.6	-55 to +200
32061	80310952	110	70.3	7.4	5.08	15.2	
32081	80310960	50	70.3	14.9	5.1	15.2	
32086	80310962	18	70.3	14.9	5.1	15.2	
32091	80310963	85	70	16.4	5.1	15.2	

# Steel-flex I

Attenuation (nominal values at +25 °C ambient temperature)

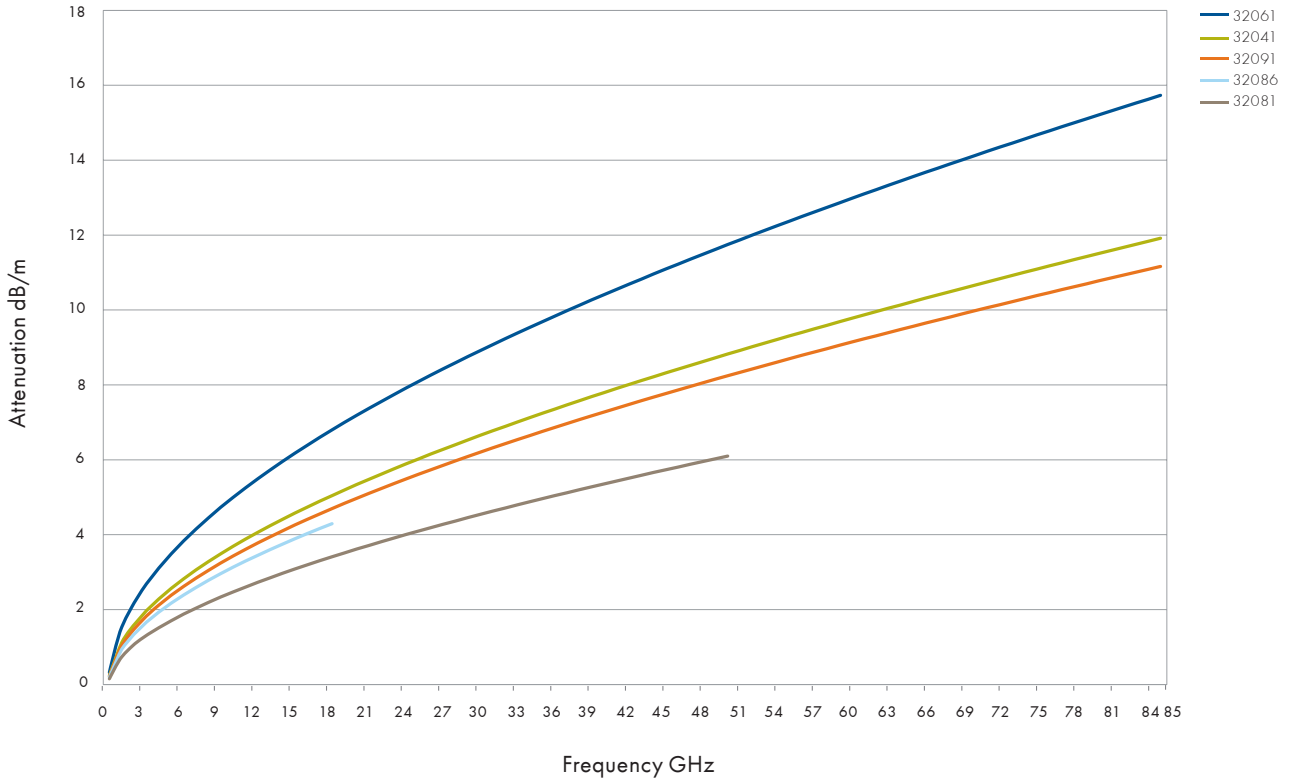

Power handling (maximum values at 25 °C ambient temperature and sea level)

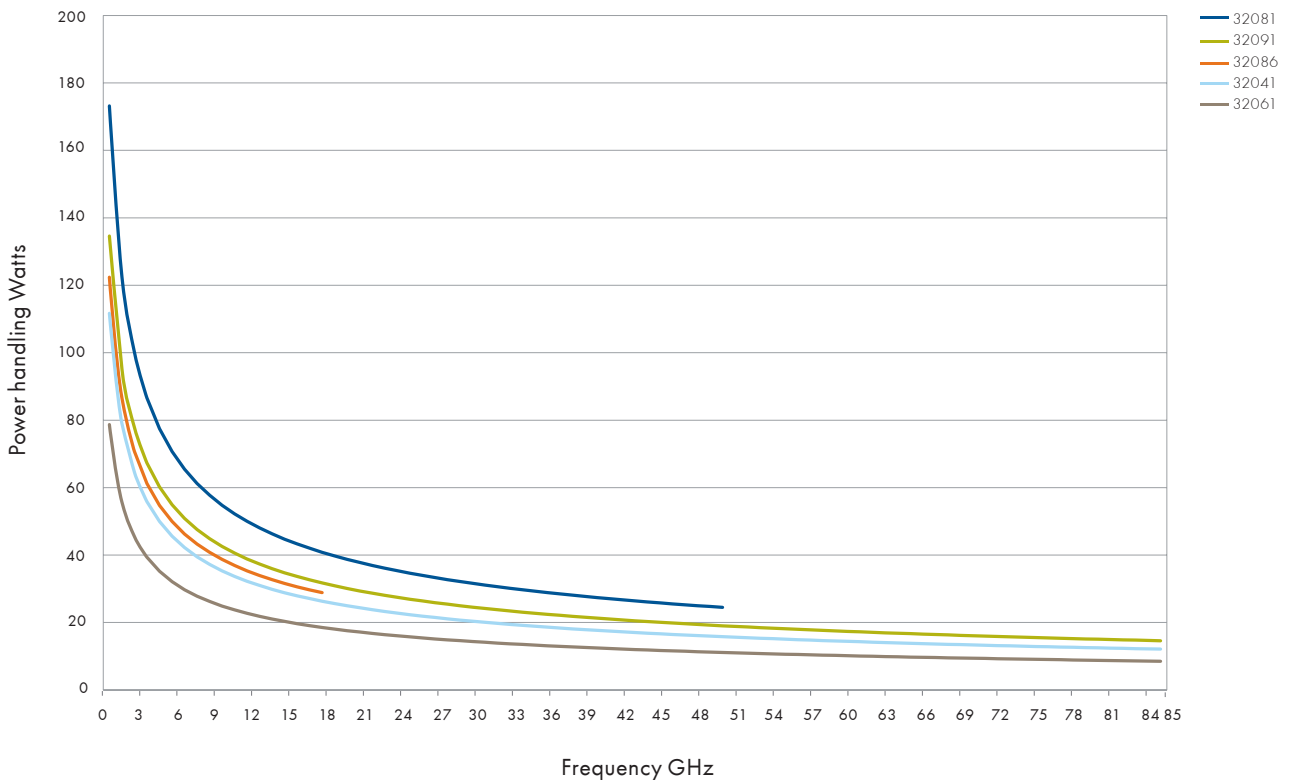

# Steel-flex I

## Available connectors

Connector	Series, pattern	HUBER+SUHNER type	Cable	Operating frequency GHz	Item no.
SMA	straight cable plug	29094CR-32-61	32061	26.5	80340299
	straight cable plug	29094-32-81	32081	24	80316324
	straight cable jack	29092-32-81		18	80316176
	straight bulkhead cable jack	29141-32-81		18	80340377
	straight cable plug	29094-32-86	32086	18	80316329
	straight cable plug	29094CR-32-91	32091	26.5	80340300
SMP	right angle 90° cable plug	29478-32-41	32041	26.5	80318009
SSMA	straight cable plug	29112-32-81S	32081	18	80340358
	right angle 90° cable plug	29111-32-81		18	80316669
TNC	straight cable plug	29714-32-81	32081	12	80319161
N	straight cable plug	29080-32-81	32081	18	80315881
BMA	straight bulkhead cable plug	29907C-32-81	32081	26	80320002
	straight bulkhead cable plug	29907CR-32-41	32041	26	80320009
SMP	straight cable jack	29473CR-32-81	32081	40	80340521
	right angle 90° cable jack	29477-32-81		20	80317999
	float mount cable jack	29921C-32-81		40	80340806
	straight cable jack	29473CR-32-41	32041	40	80340520
	right angle 90° cable jack	29473-32-41		20	80317998
	float mount cable jack	29921CR-32-41		40	80317036
SMPM	right angle 90° cable jack	29973-32-41	32041	40	80320222
	straight cable jack	29971CR-32-41		40	80320212
SMPM-T	straight cable jack	29971TCR-32-41	32041	65	80320214
SMK	straight cable plug	29094KCR-32-91	32091	40	80370561
1 mm	straight plug	29840-32-61	32061	110	80340724

# Multiflex 86/141

The flexible alternative to semi-rigid

## Product description

Multiflex microwave cables are the flexible alternative to semi-rigid cables. They are used in commercial and military RF and microwave airborne systems, communication systems, cellular base stations, satellite, ground systems - in brief: anywhere a «flexible semi-rigid cable» is required.



## Product features

- Impedance 50 Ω
- Applicable up to 67 GHz
- Comparable electrical performance as corresponding semi-rigid cable types, high screening
- High flexibility: no 3D drawings required for design and manufacture
- Semi-rigid connectors can be used; quick and easy assembly
- Resistant to chemicals, oils, lubricants, humidity, etc.

## Recommended connectors

MF_86	MCX, MMBX, MMCX, MMPX, SMA, PC3.5, SK, PC1.85, BMA, QMA
MF_86_HE	
MF_141	SMA, PC3.5, BMA, QMA, BNC, TNC, N
	Other connectors available on request.

## Construction

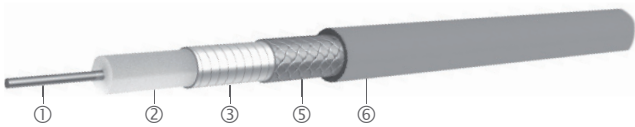

MF 86/141

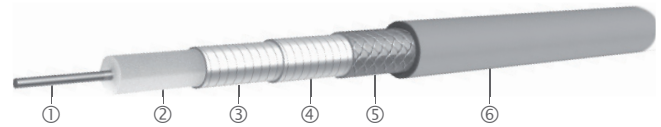

MF 86 HE

Cable	Inner conductor ①	Dielectric ②	Outer conductor ③ ④ ⑤	Jacket ⑥	Outer diameter mm	Screening effectiveness (up to 18 GHz) dB
Multiflex_86	CuAg Wire	PTFE	CuAg tape CuSn braid	FEP, blue	2.7	> 90
Multiflex_86_HE	CuAg Wire	PTFE	double CuAg tape/ braid	FEP, blue	2.7	> 90
Multiflex_141	CuAg Wire	PTFE	CuAg tape CuSn braid	FEP, blue	4.2	> 90

Other Multiflex cables on request.

## Technical data

Cable	Item no.	Max. operating frequency	Velocity of propagation	Weight g/m	Min. bending radius		Temperature range °C
		GHz	%		static mm	repeated mm	
Multiflex_86	22511965	40	71	21	6	20	-65 to +165
Multiflex_86_HE	84129072	67	71	21	10	20	-65 to +165
Multiflex_141	22511964	33	71	45	10	40	-65 to +165

# Multiflex 86/141

Attenuation (nominal values at +25 °C ambient temperature)

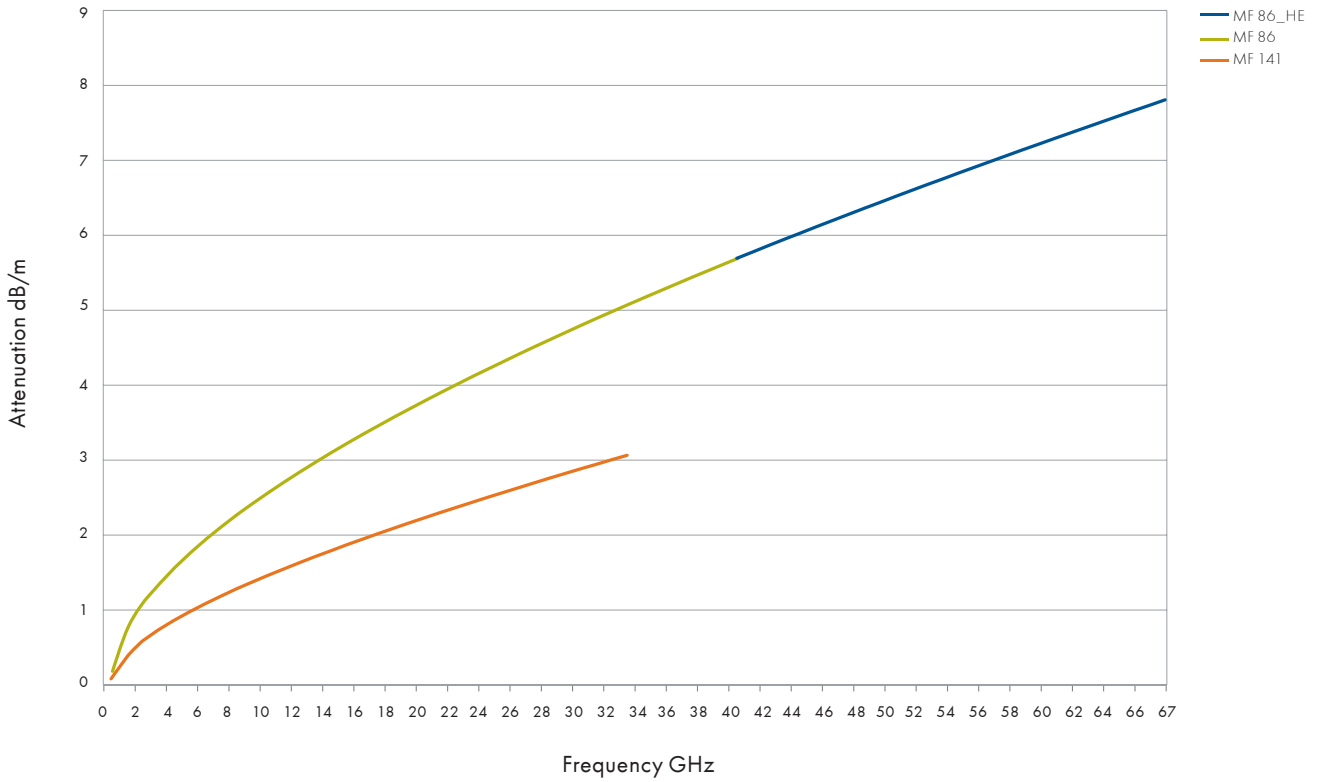

Power handling (maximum values at 25 °C ambient temperature and sea level)

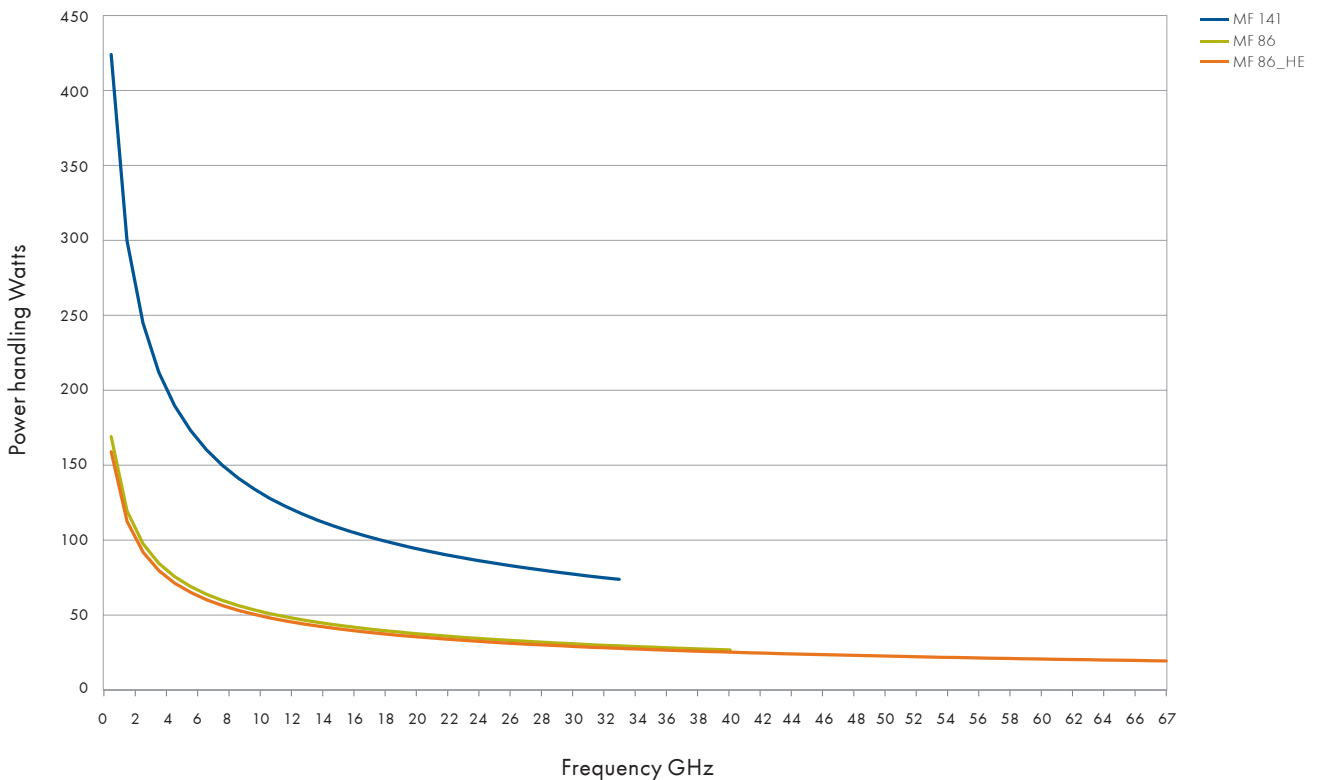

# Multiflex 86/141

## Available connectors

Connector	Series, pattern	HUBER+SUHNER type	Cable	Operating frequency GHz	Item no.
MCX	straight cable plug	11_MCX-50-2-19/111_NE	MF 86 / MF 86_HE	6	23024699
	right angle cable plug	16_MCX-50-2-104/111_NH-1		6	23032067
	right angle cable plug	16_MCX-50-2-104/111_NH		6	22658277
	straight panel bulkhead cable jack	24_MCX-50-2-3/111_NE		6	22543580
MMBX	straight cable plug	11_MMBX-50-2-4/111_NE	MF 86 / MF 86_HE	12.4	84026769
	right angle cable plug	16_MMBX-50-2-4/111_NE		12.4	84026740
	straight panel bulkhead cable jack	24_MMBX-50-2-2/111_NH		12.4	23037876
MMCX	straight cable plug	11_MMCX-50-2-1/111_OE	MF 86 / MF 86_HE	6	22645297
	right angle cable plug	16_MMCX-50-2-13/111_OE		6	84032569
	straight cable jack	21_MMCX-50-2-1/111_OE		6	22645290
	straight panel bulkhead cable jack	24_MMCX-50-2-1/111_OE		6	22645954
MMPX	straight cable plug	11_MMPX-50-2-3/111_NE	MF 86_HE	67	84089228
	right angle cable plug	16_MMPX-50-2-2/111_NE	MF 86_HE	67	84067778
N	straight cable plug	11_N-50-2-15/113_UE	MF 86 / MF 86_HE	18	22660315
	right angle cable plug	16_N-50-2-9/13_UH		11	23013729
	straight cable jack	21_N-50-2-14/133_NE		18	22642666
	straight panel bulkhead cable jack	24_N-50-2-14/133_NE		18	22544637
	straight panel cable jack, flange mount	25_N-50-2-14/133_NE		18	22641303
PC 1.85	straight cable plug	11_PC185-50-2-4/19_NE	MF 86_HE	67	84144282
	straight cable jack	21_PC185-50-2-4/19_NE		67	84144175
PC 3.5	straight cable plug	11_PC35-50-2-5/199_UE	MF 86_HE	33	84139219
	straight cable jack	21_PC35-50-2-5/199_UE		33	84139085
	straight panel bulkhead cable jack	24_PC35-50-2-5/199_UE		33	84139301
QMA	straight cable plug	11_QMA-50-2-3/133_NE	MF 86 / MF 86_HE	6	23017704
	right angle cable plug	16_QMA-50-2-3/133_NE		6	23017666
	straight panel bulkhead cable jack	24_QMA-50-2-1/111_NE		6	23017742
SK	straight cable plug	11_SK-50-2-60/199_NE	MF 86_HE	40	84098644
	straight cable jack	21_SK-50-2-61/199_NE		40	84094378
SMA	straight cable plug	11_SMA-50-2-65/119_NE	MF 86 / MF 86_HE	18	22642315
	right angle cable plug	16_SMA-50-2-43/133_NE		18	22641953
	straight cable jack	21_SMA-50-2-15/111_NE		18	22544549
	straight panel bulkhead cable jack	24_SMA-50-2-15/111_NE		18	22544532

# Multiflex 86/141

Connector	Series, pattern	HUBER+SUHNER type	Cable	Operating frequency GHz	Item no.
SMB	straight cable plug	11_SMB-50-2-13/111_NE	MF 86 / MF 86_HE	4	22543362
	right angle cable plug	16_SMB-50-2-23/111_NE		4	22644079
	straight panel bulkhead cable jack	24_SMB-50-2-13/111_NE		4	22640822
SMC	straight cable plug	11_SMC-50-2-13/111_NE	MF 86 / MF 86_HE	10	22543363
	right angle cable plug	16_SMC-50-2-25/111_NE		10	22644126
	straight panel bulkhead cable jack	24_SMC-50-2-13/111_NE		10	22640297
TNC	straight cable plug	11_TNC-50-2-20/103_NE	MF 86 / MF 86_HE	11	22642519
	straight panel bulkhead cable jack	24_TNC-50-2-31/133_NE		11	23001721
N	straight cable plug	11_N-50-3-13/113_NE	MF 141	11	22542083
	straight cable plug	11_N-50-3-51/133_NE		18	22543919
	right angle cable plug	16_N-50-3-15/133_NE		11	22648832
	straight cable jack	21_N-50-3-11/133_NE		18	22543921
	straight panel bulkhead cable jack	24_N-50-3-14/133_NE		18	22542300
	straight panel bulkhead cable jack	24_N-50-3-51/19_NE		18	22642344
	straight panel cable jack, flange mount	25_N-50-3-9/133_NE		11	22543952
PC3.5	straight cable plug	11_PC35-50-3-4/199_UE	MF 141	33	84009380
	straight cable jack	21_PC35-50-3-3/199_UE		33	84009382
	straight panel bulkhead cable jack	24_PC35-50-3-2/199_UE		33	84009383
QMA	straight cable plug	11_QMA-50-3-3/133_NE	MF 141	6	23017695
	right angle cable plug	16_QMA-50-3-3/133_NE		6	23017693
	straight panel bulkhead cable jack	24_QMA-50-3-3/111_NE		6	23017683
QN	straight cable plug	11_QN-50-3-3/113_NE	MF 141	11	23033393
	right angle cable plug	16_QN-50-3-3/13_NE		11	23033268
	straight panel bulkhead cable jack	24_QN-50-3-3/13_NE		11	23033423
SMA	straight cable plug	11_SMA-50-3-77/119_NH	MF 141	18	84005524
	straight cable plug	11_SMA-50-3-235/133_NE		18	84130698
	right angle cable plug	16_SMA-50-3-3/111_NE		18	22640073
	straight cable jack	21_SMA-50-3-15/111_NE		18	22544550
	straight panel bulkhead cable jack	24_SMA-50-3-15/111_NE		18	22641153
TNC	straight cable plug	11_TNC-50-3-29/103_NE	MF 141	11	22641997
	straight panel bulkhead cable jack	24_TNC-50-3-30/133_NH		11	23001723

# S-series

The economical, low loss microwave cable

## Product description

The S-series is a line of cost-efficient, low loss microwave cables. It covers technically demanding requirements in a wide range of applications, preferably in fixed installations. These versatile cables are characterised by their very low insertion loss across a wide frequency range. S-series cables are easy to assemble and are made of environmentally friendly, halogen free materials.

## Product features

- Impedance 50 Ω
- Applicable up to 18 GHz
- Low insertion loss
- Excellent screening effectiveness
- Quick and easy to assemble
- Low smoke, free of halogen free version available
- Cost-efficient, environmentally friendly solution for a wide range of applications



## Recommended connectors

S_04272_B	SMA, TNC, N
S_04262_B-01	SMA, TNC, N
	Other connectors available on request.

## Construction

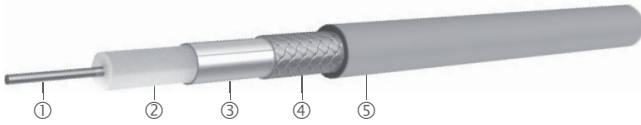

Cable	Inner conductor ①	Dielectric ②	Outer conductor ③ ④	Jacket ⑤	Outer diameter mm	Screening effectiveness up to 18 GHz dB
S_04272_B	CuAg Wire	SPE	Al tape/CuSn braid	PE, blue	5.5	> 90
S_04262_B-01	CuAg Wire	SPE	Al tape/CuSn braid	LSFH, black	5.5	> 90
S_04212_B	CuAg Wire	SPE	Al tape/CuSn braid	PUR, black	5.5	> 90

## Technical data

Cable	Item no.	Max. operating frequency	Velocity of propagation	Weight g/m	Min. bending radius		Temperature range °C
		GHz	%		static mm	repeated mm	
S_04272_B	22511622	18	82	44	25	90	-40 to +85
S_04262_B-01	84000918	18	82	41	25	90	
S_04212_B	22511855	18	82	41	25	90	



# S-series

Attenuation (nominal values at +25 °C ambient temperature)

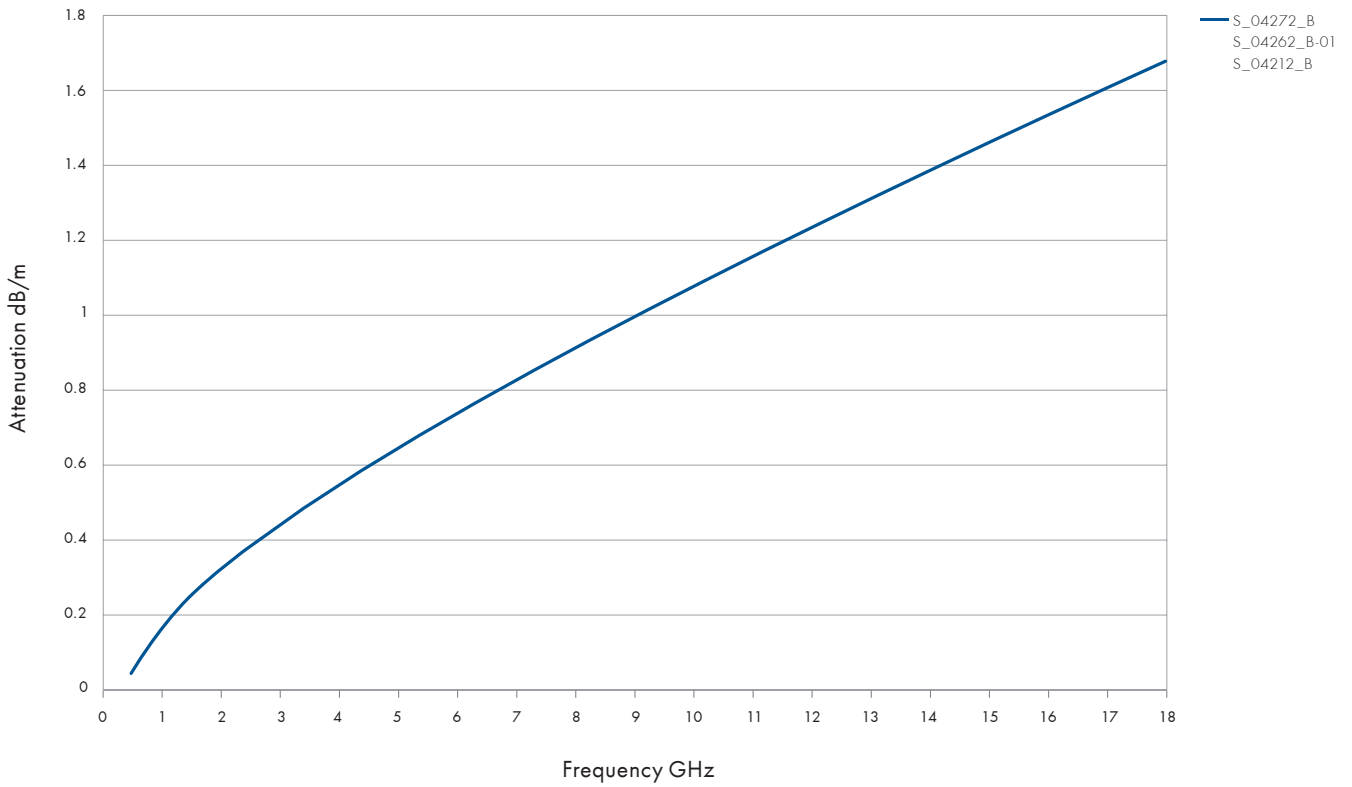

Flexible assemblies

Power handling (maximum values at 25 °C ambient temperature and sea level)

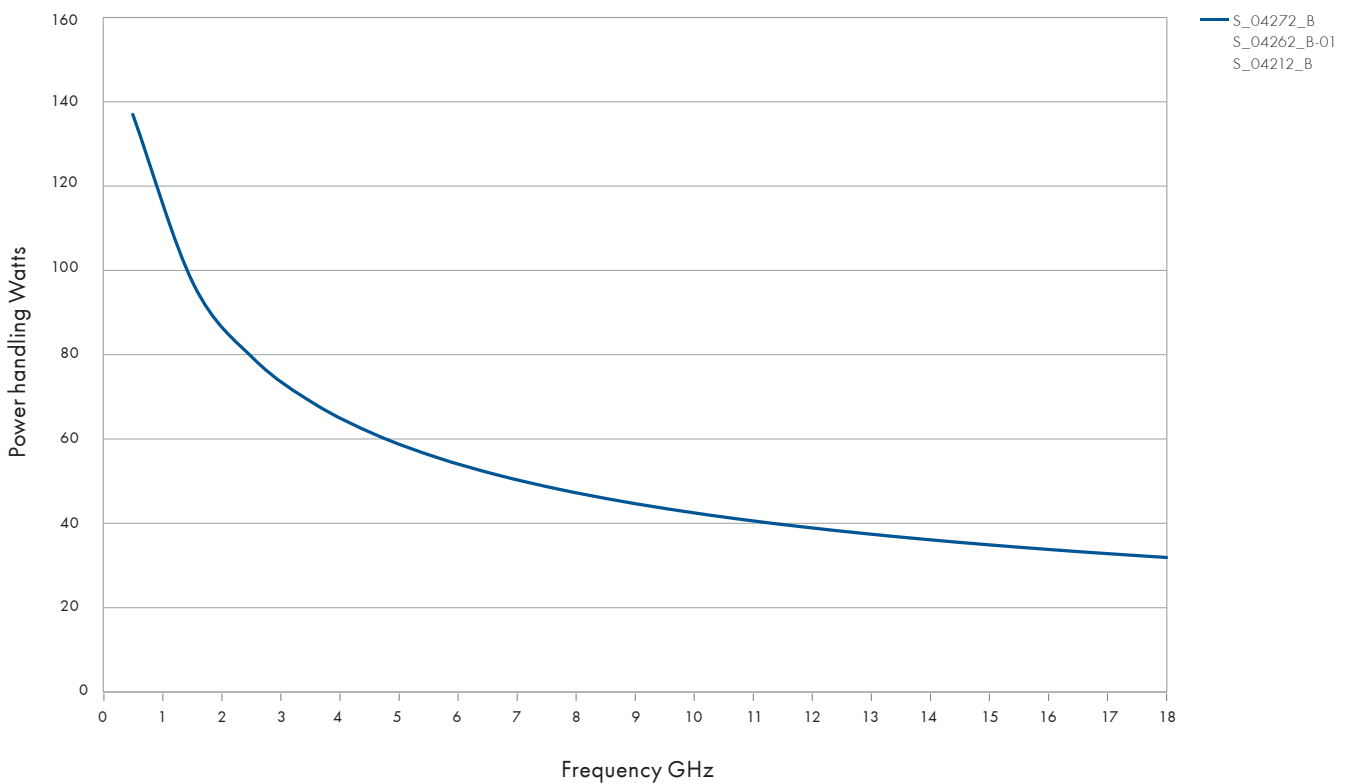

# S-series

## Available connectors

Connector	Series, pattern	HUBER+SUHNER type	Cable	Operating frequency GHz	Item no.
N	straight cable plug	11_N-50-4-10/133_NH	S_04272_B, S_04262_B-01 S_04212_B	11	84026255
	straight cable plug	11_N-50-4-55/133_NE		18	22645935
	right angle cable plug	16_N-50-4-53/199_NE		18	22645021
	straight panel bulkhead cable jack	24_N-50-4-53/133_NE		18	22644946
SMA	straight cable plug	11_SMA-50-4-53/139_NE	S_04272_B, S_04262_B-01 S_04212_B	18	22644342
	right angle cable plug	16_SMA-50-4-50/133_NE		18	84130714
	straight cable jack	21_SMA-50-4-52/133_NE		18	22644409
TNC	straight cable plug	11_TNC-50-4-52/133_NE	S_04272_B, S_04262_B-01 S_04212_B	11	22644434
	straight panel bulkhead cable jack	24_TNC-50-4-52/133_NE		11	22644938

# Ever-flex

The high flexibility microwave coaxial cable assemblies

## Product description

Ever-flex cables were designed for use in ultradurable, high flexure applications such as gimbal assemblies and installations where the cable assembly must endure multiple tight bends and twists. ever-flex cable assemblies have repeatedly endured 1 000 000 flexure cycles with minimal electrical and mechanical degradation. All incorporate a flat wire outer conductor and a microporous dielectric for low loss and a tight woven stainless steel outer braid for improved resistance to crushing, bending and kinking.

## Product features

- Impedance 50 Ω
- Applicable up to 40 GHz
- High reliability
- Light weight
- Low loss
- Broad bandwidth



## Recommended connectors

32084	SMA, SSMA, SK
-------	---------------

## Construction

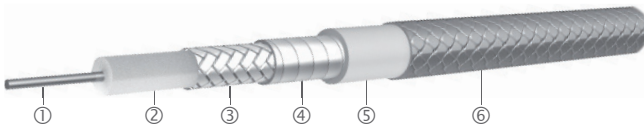

Cable	Inner conductor ①	Dielectric ②	Outer conductor ③	Outer tape ④	Jacket ⑤	Ruggedisation ⑥	Outer diameter mm
32084	CuAg strand	PTFE, microporous	CuAg flat wire braid	polyimide/aluminium	silicone rubber	stainless steel	2.4

## Technical data

Cable	Item no.	Max. operating frequency	Velocity of propagation	Weight g/m	Min. bending radii		Temperature range °C
		GHz	%		static mm	repeated mm	
32084	80310961	40	76	10.4	5.1	15.2	-55 to +200

## Available connectors

Connector	Series, pattern	HUBER+SUHNER type	Cable	Operating frequency GHz	Item no.
SMA	straight cable plug	29094-32-84	32084	18	80316327
	right angle 90° cable plug	29200-32-84		18	80316980
SSMA	straight cable plug	29112-32-84		18	80316698
	right angle 90° cable plug	29111-32-84		12	80340354
SK	straight cable plug	29094K-32-84		40	80316384

# Ever-flex

Attenuation (nominal values at +25 °C ambient temperature)

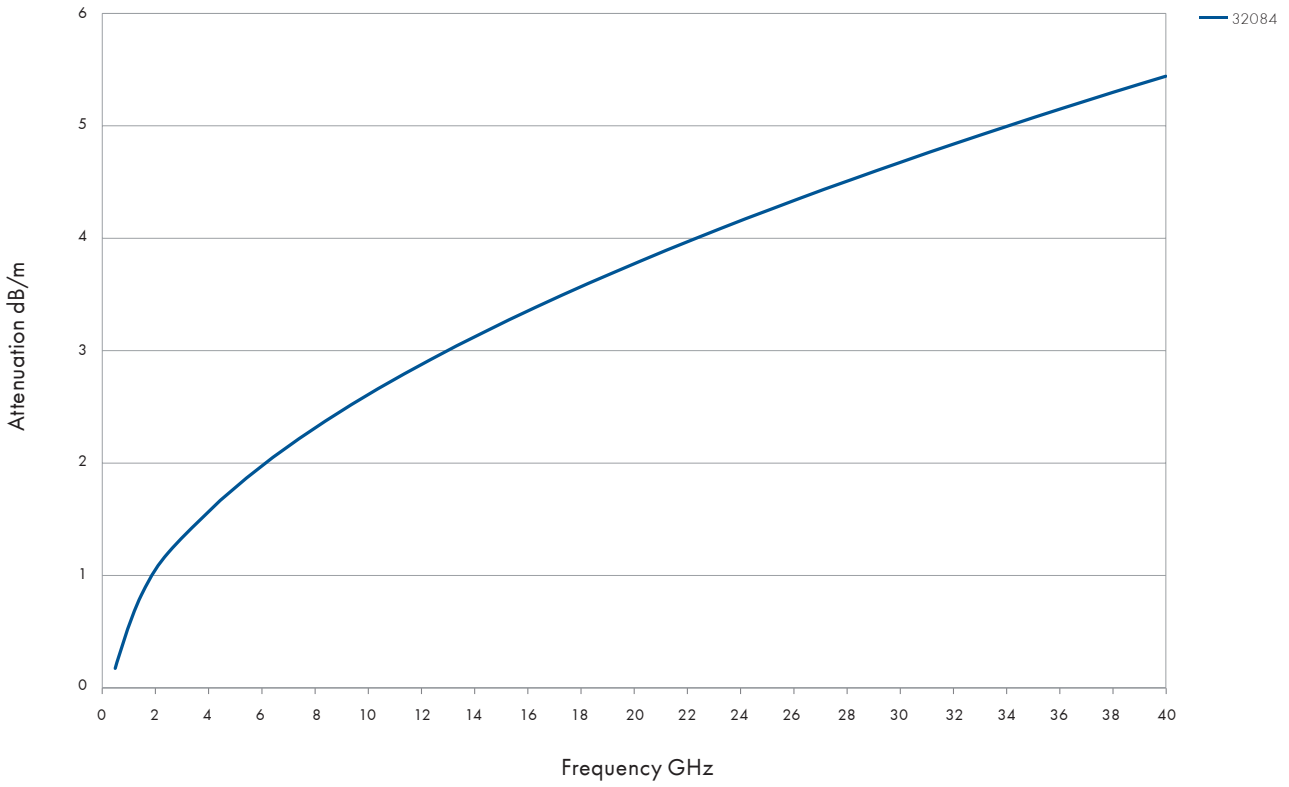

Power handling (maximum values at 25 °C ambient temperature and sea level)

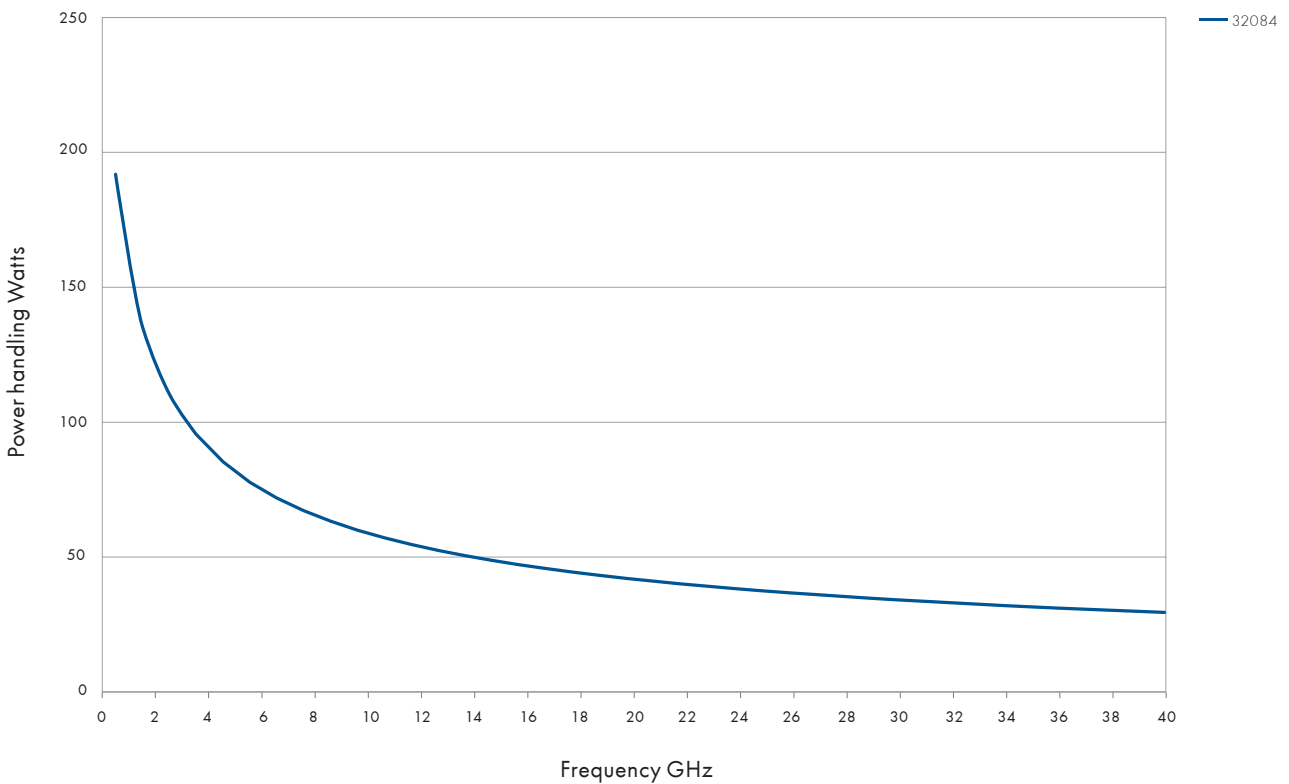

# Multiflex 53-02

The highly flexible microwave cable

## Product description

The thin, highly flexible and ultra-stable microwave cable for utmost demands.

## Product features

- Impedance 50 Ω
- Applicable up to 67 GHz
- 50 000 flex cycles



## Recommended connectors

MF 53-02	SMA, SK, PC2.4, MMPX
	Other connectors available on request

## Construction

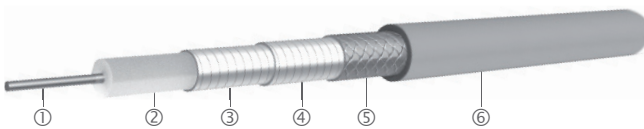

Cable	Inner conductor ①	Dielectric ②	Outer conductor ③ ④ ⑤	Jacket ⑥	Outer diameter	Screening effectiveness (up to 18 GHz)
					mm	dB
Multiflex_53-02	CuAg Wire	PTFE	double CuAg tape/ braid	FEP, blue	1.74	> 90

## Technical data

Cable	Item no.	Max. operating frequency	Velocity of propagation	Weight	Min. bending radii		Temperature range
		GHz	%		static mm	repeated mm	°C
Multiflex_53-02	85006318	67	71	8.5	10	20	-65 to + 165

## Available connectors

Connector	Series, pattern	HUBER+SUHNER type	Cable	Operating frequency	Item no.
				GHz	
SK	straight cable plug	11_SK-U50-1-5/119_NH	MF 53-02	40	84087678
PC2.4	straight cable plug	11_PC24-U50-1-1/119_NH		50	85028108
MMPX	straight cable plug	11_MMPX-50-1-4/111_NE		67	84122130
SMA	straight cable jack	21_SMA-50-1-5/111_NH		18	85016291

# Multiflex 53-02

Attenuation (nominal values at +25 °C ambient temperature)

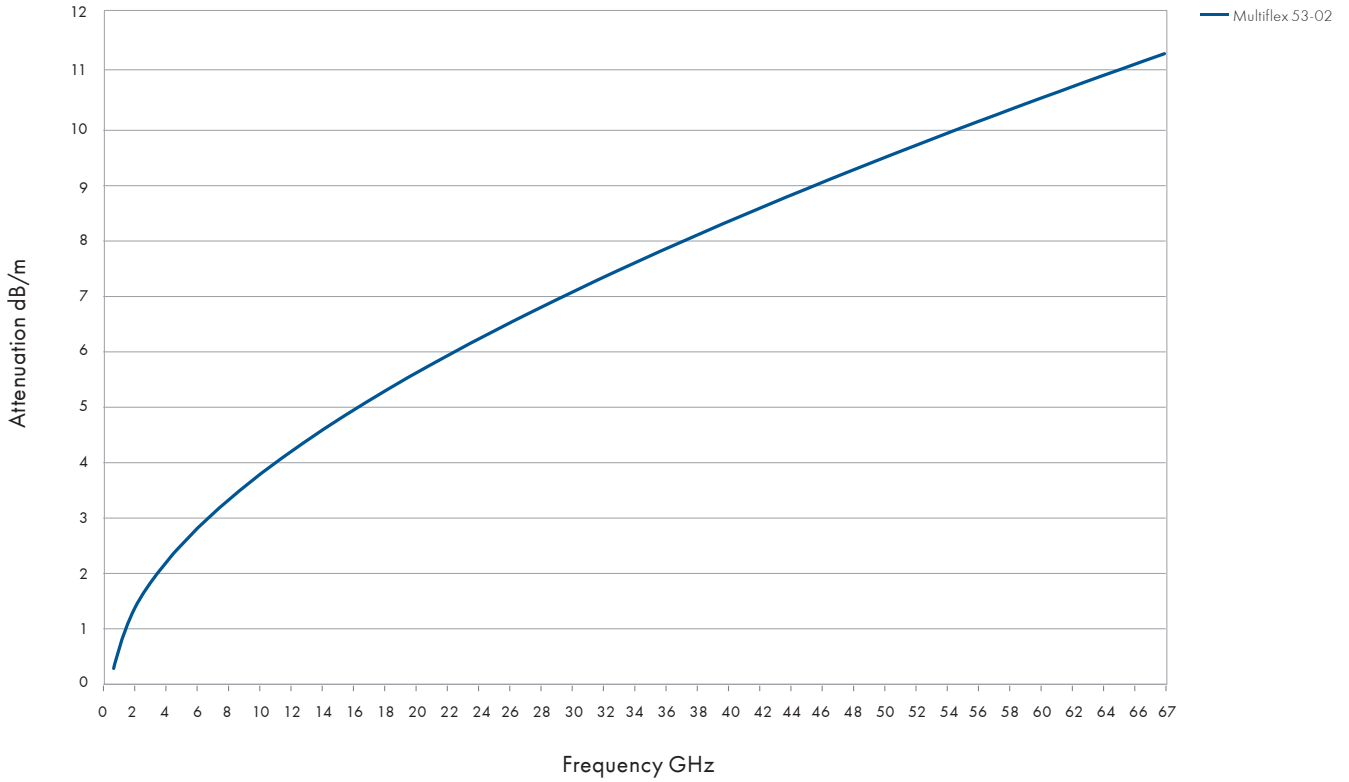

Power handling (maximum values at 25 °C ambient temperature and sea level)

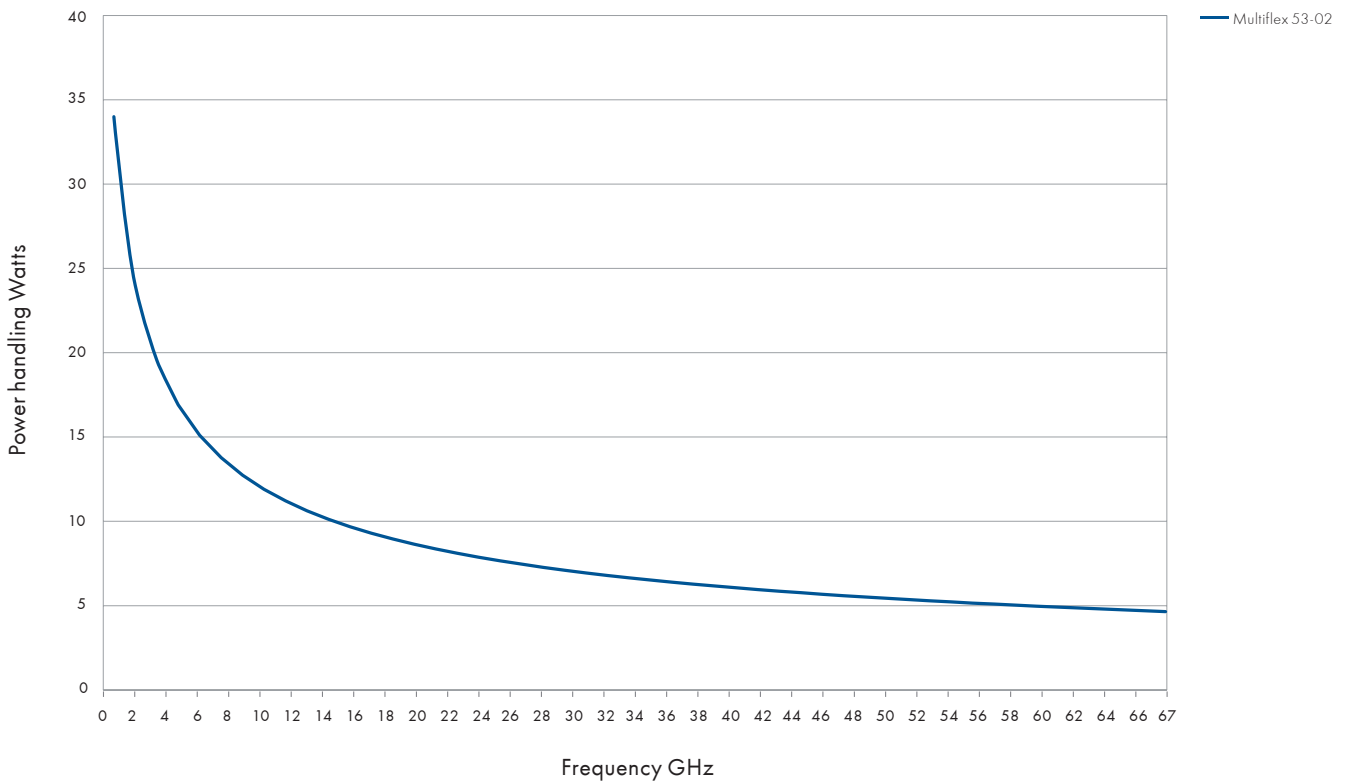

# Boa-flex III

## MIL-DTL-17 replacement coaxial cables

### Product description

Boa-flex III cable is low cost, high performance designs intended to replace standard flexible MIL-DTL-17 cables. This cable has up to three shields as indicated in the table below. All have a solid core for excellent crush resistance without the need for armor.



### Product features

- Impedance 50 Ω
- Applicable up to 12 GHz
- Solid teflon dielectric
- Low loss MIL-DTL-17 replacements
- Utilises most standard connectors
- Operating temperature -55 to +200 °C
- Other custom cables available upon request

### Recommended connectors

32018DS	SMA, SSMA, SMP
---------	----------------

### Construction

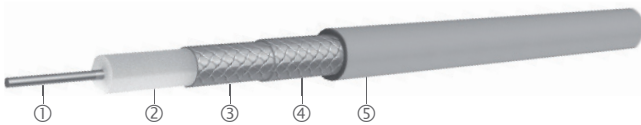

Cable	Inner conductor ①	Dielectric ②	Outer conductor ③	Outer braid ④	Outer jacket ⑤	Outer diameter
32018DS	CuAg wire	PTFE	CuAg braid	CuAg	FEP, black	1.3

### Technical data

Cable	Item no.	Max. operating frequency	Velocity of propagation	Weight	Min. bending radii		Temperature range
		GHz	%		static mm	repeated mm	
32018DS	80320957	12	70.3	4.5	4.6	13.7	-55 to +200

### Available connectors

Connector	Series, pattern	HUBER+SUHNER type	Cable	Operating frequency	Item no.
				GHz	
SMA	straight cable plug	29094-32-18DS	32018DS	12	80316273
SSMA	straight cable plug	29112-32-18DS		12	80395393
	right angle 90° cable plug	29111-32-18DS		12	80395394
SMP	straight cable jack	29473-32-18DS		12	80340514

# Boa-flex III

Attenuation (nominal values at +25 °C ambient temperature)

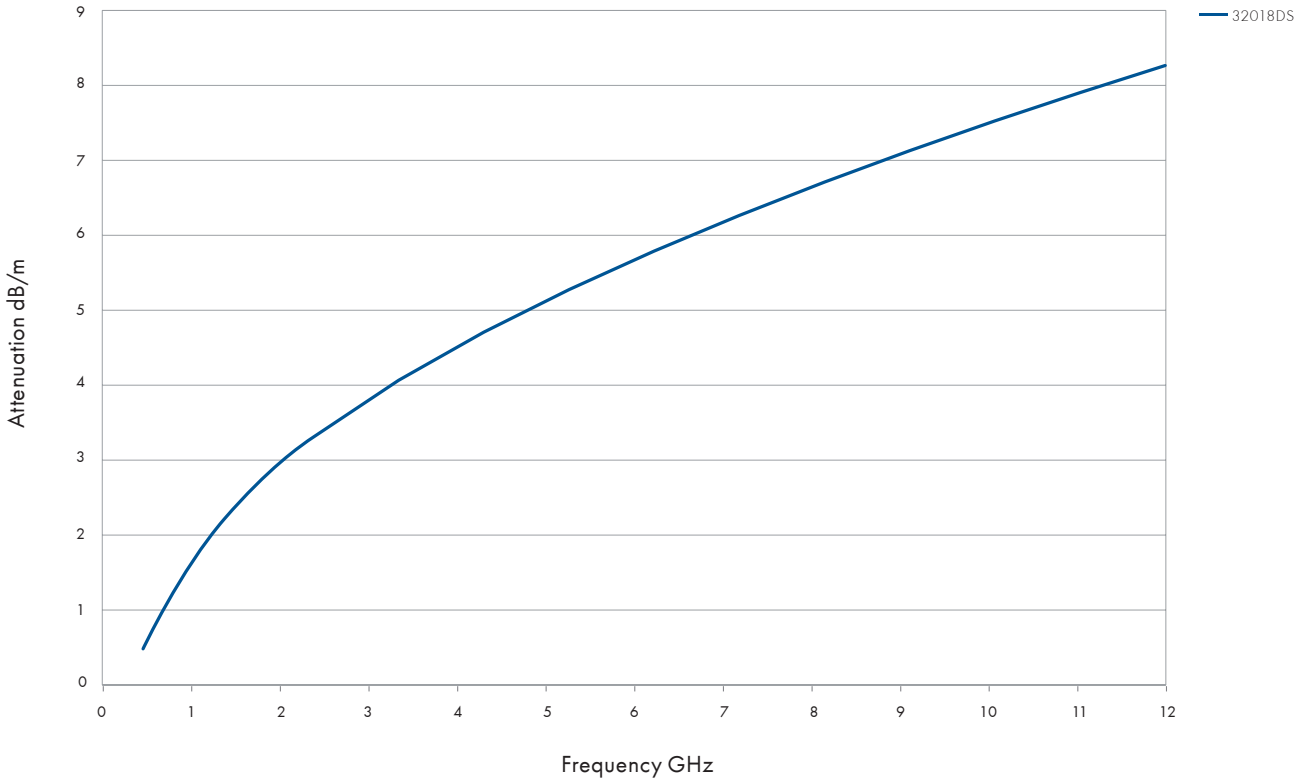

Power handling (maximum values at 25 °C ambient temperature and sea level)

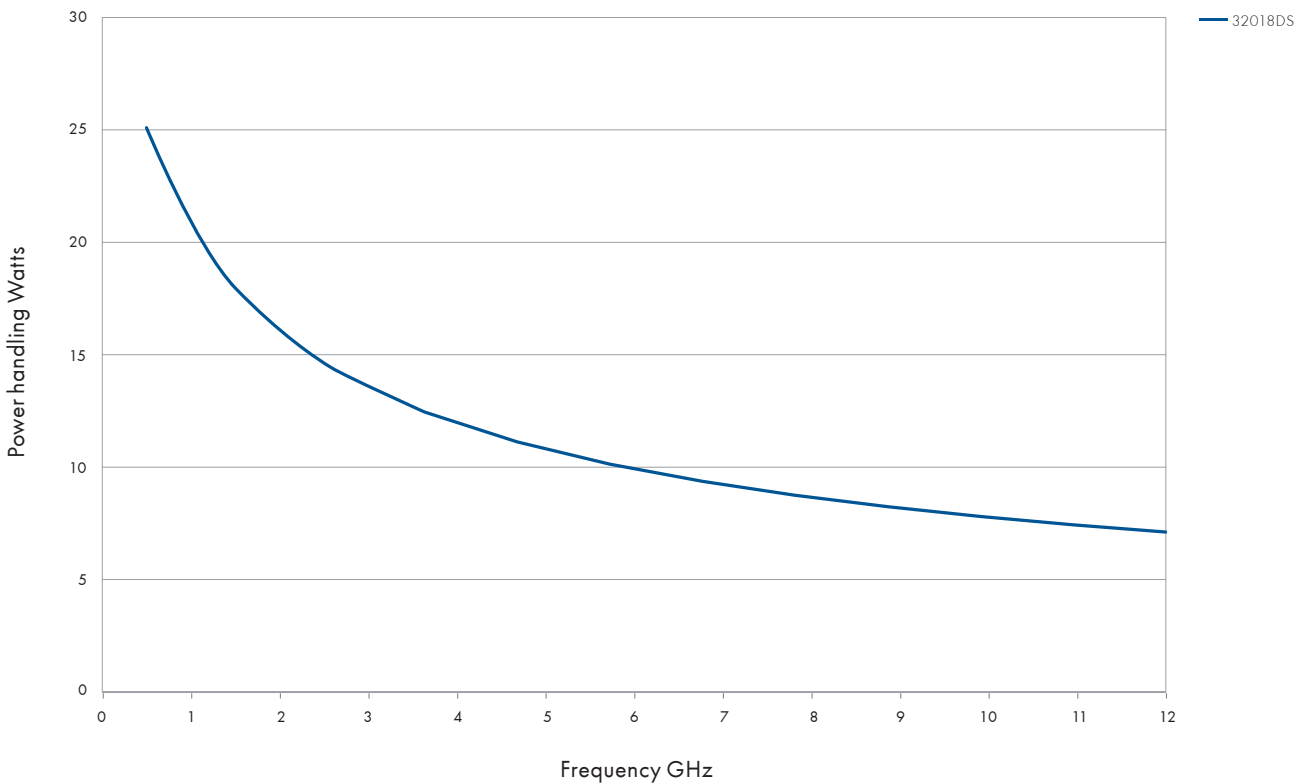



# Boa-flex II

The high power, low loss microwave coaxial cable assemblies

## Product description

Boa-flex II cables utilise a microporous PTFE dielectric for low loss with minimal phase change due to temperature changes and flexure. Typical velocity is 77 % of the speed of light. All offer very low loss and are extremely stable with flexure.

## Product features

- Impedance 50 Ω
- Applicable up to 14 GHz
- Low density PTFE for superior electrical performance
- Helical wrapped outer conductor for increased electrical performance
- Exceptional phase and IL stability with flexure
- Excellent phase versus temperature characteristics
- Preferred for phase matching and tracking applications



## Recommended connectors

32071	TNC, N, SC
	Others available

## Construction

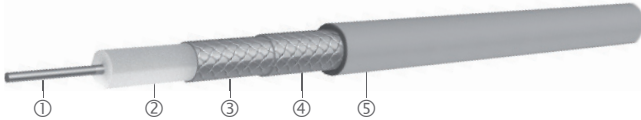

Cable	Inner conductor ①	Dielectric ②	Outer conductor ③	Outer braid ④	Outer braid ⑤	Outer diameter mm
32071	CuAg strand	PTFE microporous	CuAg tape	CuAg	FEP, translucent amber	9.5

## Technical data

Cable	Item no.	Max. operating frequency	Velocity of propagation	Weight g/m	Min. bending radius		Temperature range °C
		GHz	%		static mm	repeated mm	
32071	80310956	14	77.8	208.3	50.8	101.6	-55 to +200

## Available connectors

Connector	Series, pattern	HUBER+SUHNER type	Cable	Operating frequency GHz	Item no.
TNC	straight cable plug	29614-32-71	32071	10	80318585
N	straight cable plug	29602-32-71		12.4	80318491
	straight cable jack	29601-32-71		12.4	80318466
	straight bulkhead cable jack	29636-32-71		12.4	80340623
SC	straight cable plug	29608-32-71		10	80318547

# Boa-flex II

Attenuation (nominal values at +25 °C ambient temperature)

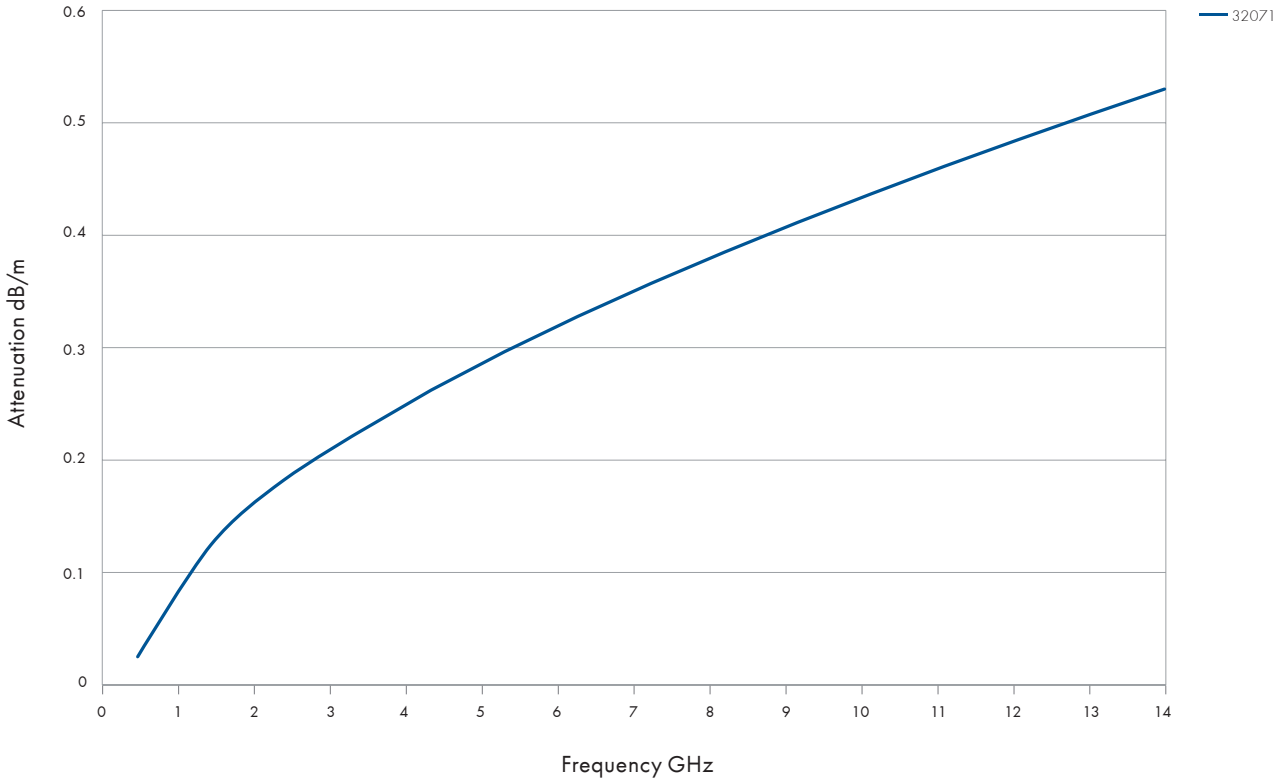

Power handling (maximum values at 25 °C ambient temperature and sea level)

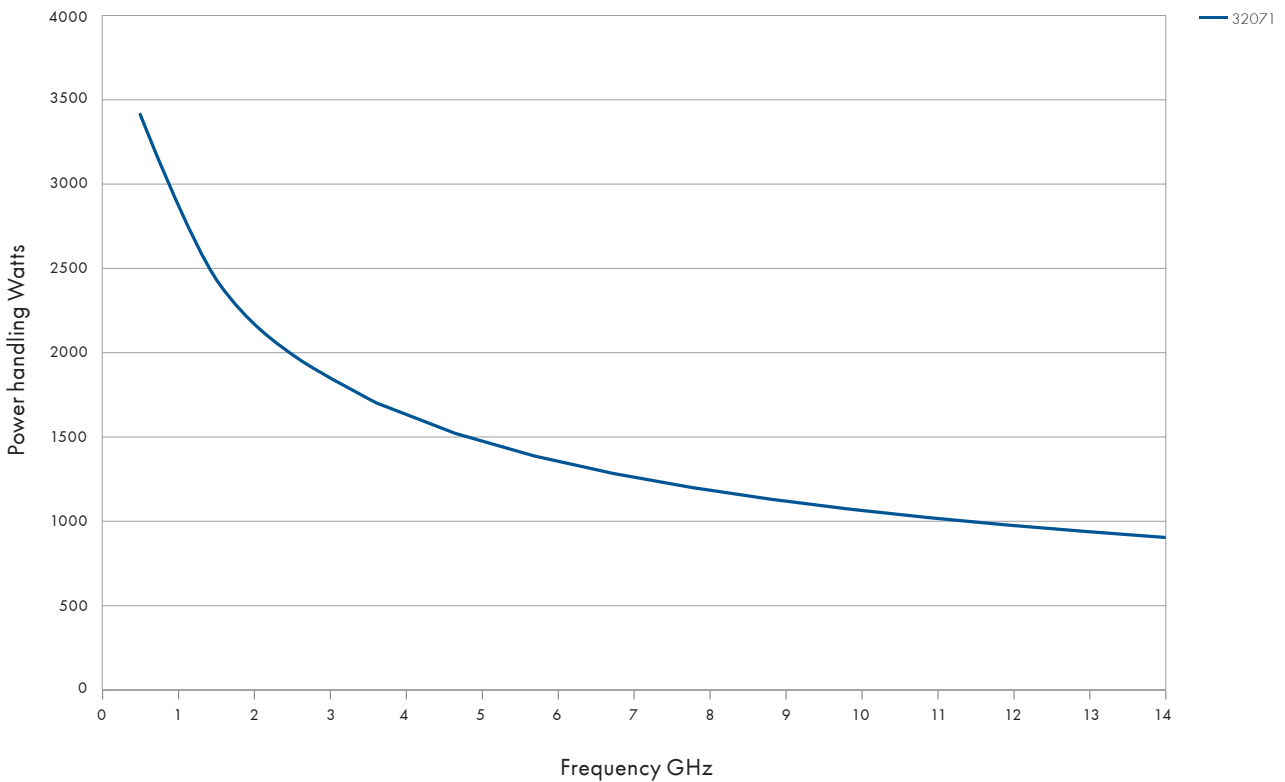

# Eacon

The field terminated microwave assembly

## Product description

To suit to the needs of our customers, HUBER+SUHNER has developed this innovative solution. Eacon stands for a simple, flexible and fast way to assemble microwave cable and connectors in the field without compromises to the best performance. The new field terminated microwave cable and connectors are light and waterproofed, built for frequencies up to 18 GHz - ready for use in the defense market as well as generally in the industrial market.

## Product features

- Impedance 50 Ω
- Applicable up to 18 GHz
- Velocity of propagation 77%
- Field terminated
- Waterproof IP 67
- Low loss
- Extremely reliable
- Assembling tool kits available
- Easy assembling - only two connector parts
- Taking on site decision regarding length and configurations
- Narrowest cable feedthrough dimensions (assembling after installation)
- More added value for customers



Flexible assemblies

## Recommended connectors

Eacon_2C	SMA
Eacon_4C	BNC, N, QMA, SMA, TNC
Eacon_6C	TNC, N
	Other connectors available on request.

## Construction

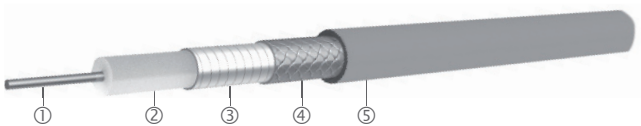

Cable	Item no.	Inner conductor ①	Dielectric ②	Outer conductor ③ ④	Jacket ⑤	Outer Diameter mm
Eacon_2C	84116378	CuAg Wire	LD-PTFE	CuAg tape / SiCuAg braid	FEP, white	3.75
Eacon_4C	84048293	CuAg Wire	LD-PTFE	CuAg tape / braid	FEP, white	5.50
Eacon_6C	84116403	CuAg Wire	LD-PTFE	CuAg tape / braid	FEP, white	7.70

# Eacon

## Assembly types

		Eacon_2C	Eacon_4C	Eacon_6C
Construction				
Max. operating frequency	GHz	18	18	18
Application		static	static	static
Velocity of propagation	%	77	77	77
Weight	g/m	39	73	148
Min. bending radius static	mm	12	16	24
Min. bending radius repeated	mm	20	25	40
Temperature range	°C	-55 to +200	-55 to +200	-55 to +200
Tensile load	N	100	180	180
Crush resistance	kN/m	8	8	8
Inner conductor		wire	wire	wire
Dielectric		LD-PTFE	LD-PTFE	LD-PTFE
Outer conductor		Tape /braid	Tape /braid	Tape /braid
Jacket		FEP	FEP	FEP
Outer diameter	mm	3.75	5.50	7.70
Screening effectiveness (up to 18 GHz)	dB	>90	>90	>90
Phase stability vs. flexure, 360°, diameter 55 mm (2C, 4C), 85 mm (6C)	°el/GHz	< 1.2	< 1.7	<2.0
Phase stability vs. temperature (-40 to +85 °C)	ppm	<1'500	< 1'500	< 1'500
Cable attenuation at 25 °C	dB/m	See graph	See graph	See graph
Power handling	watt	See graph	See graph	See graph
Smoke index		naval engineering Standard 711 and ASTM-B 622-92 (140°F for 24 hours, conditioned @ 73°F and 50% relative humidity)	naval engineering Standard 711 and ASTM-B 622-92 (140°F for 24 hours, conditioned @ 73°F and 50% relative humidity)	naval engineering Standard 711 and ASTM-B 622-92 (140°F for 24 hours, conditioned @ 73°F and 50% relative humidity)
Solar radiation		MIL-STD-810, Method 505, Procedure II	MIL-STD-810, Method 505, Procedure II	MIL-STD-810, Method 505, Procedure II
Flammability		MIL-C-87104, Paragraph 4.6.4.8	MIL-C-87104, Paragraph 4.6.4.8	MIL-C-87104, Paragraph 4.6.4.8
Chemical resistance		British Standard 3G100, Part 2, Section 3, Class A	British Standard 3G100, Part 2, Section 3, Class A	British Standard 3G100, Part 2, Section 3, Class A
Fungus		MIL-STD-810, Method 508.3	MIL-STD-810, Method 508.3	MIL-STD-810, Method 508.3
RoHS (2002/95/EC)		compliant	compliant	compliant

# Eacon

Attenuation (nominal values at +25 °C ambient temperature)

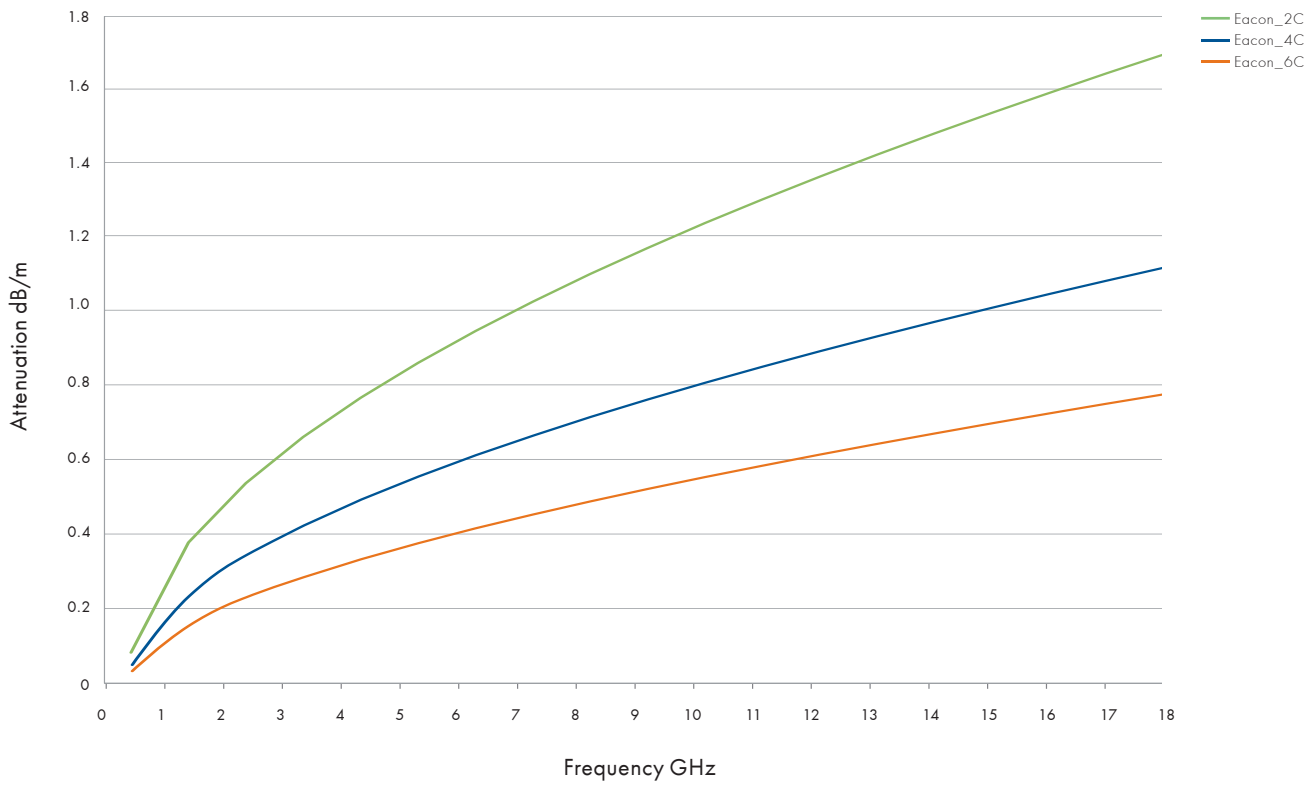

Flexible assemblies

Power handling (maximum values at 25 °C ambient temperature and sea level)

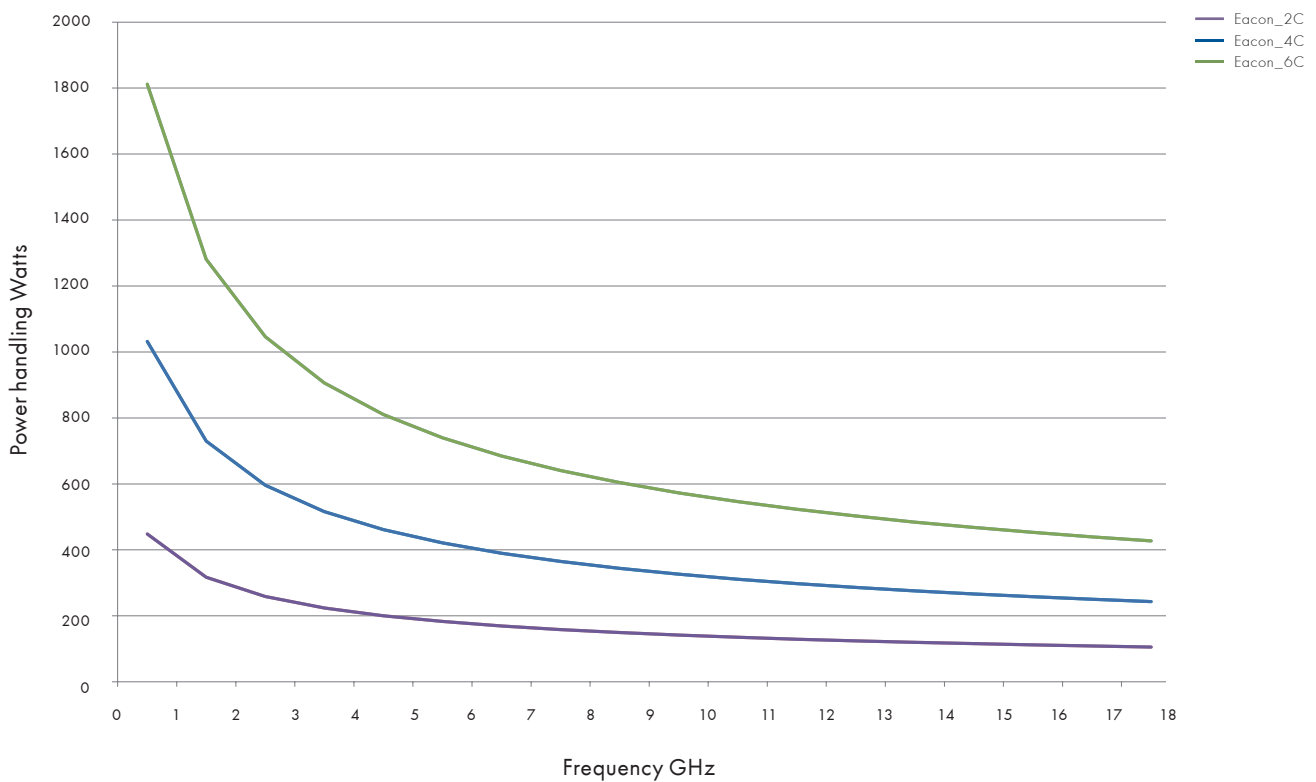

# Eacon

## Available connectors

Connector	Series, pattern	HUBER+SUHNER type			Eacon_2C	Eacon_4C	Eacon_6C	Typical VSWR			
								4 GHz	6 GHz	11 GHz	18 GHz
BNC	Straight cable plug	11_BNC-50-4-33/12_NE	84139633		•			1.15			
	Right angle cable plug	16_BNC-50-4-14/12_NE	84146122		•			1.30			
N	Straight cable plug	11_N-50-4-19/12_NE	84070286		•				1.12	1.35	1.40
	Straight cable plug	11_N-50-6-19/12_NE	85074230			•			1.12	1.15	
	Right angle cable plug	16_N-50-4-13/12_NE	84070287		•				1.12	1.15	1.25 *
	Right angle cable plug	16_N-50-6-14/12_NE	85074231			•			1.12	1.25	
	Straight panel bulkhead cable jack	24_N-50-4-13/12_NE	85005806		•				1.12		1.17
	Straight panel cable jack, flange mount	25_N-50-4-8/122_NE	84070288		•				1.12		1.17
QMA	Straight cable plug	11_QMA-W50-4-4/19_NE	84121825		•				1.12		
SMA	Straight cable plug	11_SMA-50-2-76/199_NE	85074234	•					1.13		1.30
	Straight cable plug	11_SMA-50-4-101/199_NE	84070289		•				1.12		1.15
	Right angle cable plug	16_SMA-50-2-20/199_NE	85074235	•					1.12	1.35	
	Right angle cable plug	16_SMA-50-4-165/199_NE	84070290		•				1.12	1.45	
TNC	Straight cable plug	11_TNC-50-4-23/12_NE	84070283		•				1.12	1.30	
	Straight cable plug	11_TNC-50-6-8/12_NE	85074232			•			1.09	1.22	
	Right angle cable plug	16_TNC-50-4-101/12_NE	84070284		•				1.12	1.30	
	Right angle cable plug	16_TNC-50-6-12/12_NE	85074233			•			1.17	1.35	
	Straight panel cable jack, flange mount	25_TNC-50-4-18/12_NE	84070285		•				1.12	1.20	

\*(up to 15 GHz)

# Eacon

Assembling tool kits for all connectors, used with Eacon 2C/4C/6C cables (with additional space for other auxiliary tools and spare parts).



## Combined Eacon 2C / 4C / 6C assembling tool kit

HUBER + SUHNER type	Item no.	Content	Size
74_Z-0-0-647	85075222	all tools, needed to assemble Eacon 2C / 4C / 6C	395 × 315 × 100 mm/ 15.5 × 12.4 × 3.9 in

## Eacon 2C assembling tool kit

HUBER + SUHNER type	Item no.	Content	Size
74_Z-0-0-645	85075220	all tools, needed to assemble Eacon 2C	395 × 315 × 100 mm/ 15.5 × 12.4 × 3.9 in

Pos.	HUBER + SUHNER type	Item no.	Description	Comment
1	74_Z-0-0-12	22642718	metal saw	-
2	74_Z-0-0-13	22644241	replacement of saw blade	please order separately (not incl. in the toolbox)
3	74_Z-0-0-475	84079191	torque wrench 8 mm (4 Nm)	please check the torque from time to time
4	74_Z-0-0-474	84078907	trim tool	-
5	74_Z-0-0-638	85075218	stripping tool Eacon 2C	-
6	74_Z-0-0-563	84079618	blades cartridge for stripping tool 74_Z-0-0-638	please order separately (not incl. in the toolbox)
7	74_Z-0-0-639	85075217	Cone	5 pcs.
8	74_Z-0-0-641	85075213	Fixation tool for cutting	

## Eacon 4C assembling tool kit

HUBER + SUHNER type	Item no.	Content	Size
74_Z-0-0-606	84074447	all tools, needed to assemble Eacon 4C	395 × 315 × 100 mm/ 15.5 × 12.4 × 3.9 in

Pos.	HUBER + SUHNER type	Item no.	Description	Comment
1	74_Z-0-0-12	22642718	metal saw	-
2	74_Z-0-0-13	22644241	replacement of saw blade	please order separately (not incl. in the toolbox)
3	74_Z-0-0-475	84079191	torque wrench 8 mm (4 Nm)	please check the torque from time to time
4	74_Z-0-0-474	84078907	trim tool	-
5	74_Z-0-0-473	84079184	stripping tool Eacon 4C	-
6	74_Z-0-0-563	84079618	blades cartridge for stripping tool 74_Z-0-0-473	please order separately (not incl. in the toolbox)
7	74_Z-0-0-642	85075214	Fixation tool for cutting	

## Eacon 6C assembling tool kit

HUBER + SUHNER type	Item no.	Content	Size
74_Z-0-0-646	85075221	all tools, needed to assemble Eacon 6C	395 × 315 × 100 mm/ 15.5 × 12.4 × 3.9 in

Pos.	HUBER + SUHNER type	Item no.	Description	Comment
1	74_Z-0-0-12	22642718	metal saw	-
2	74_Z-0-0-13	22644241	replacement of saw blade	please order separately (not incl. in the toolbox)
3	74_Z-0-0480	84079190	torque wrench 12 mm (5 Nm)	please check the torque from time to time
4	74_Z-0-0-474	84078907	trim tool	-
5	74_Z-0-0-640	85075219	stripping tool Eacon 6C	-
6	74_Z-0-0-564	84079619	blades cartridge for stripping tool 74_Z-0-0-640	please order separately (not incl. in the toolbox)
	74_Z-0-0-643	85075215	Fixation tool for cutting	

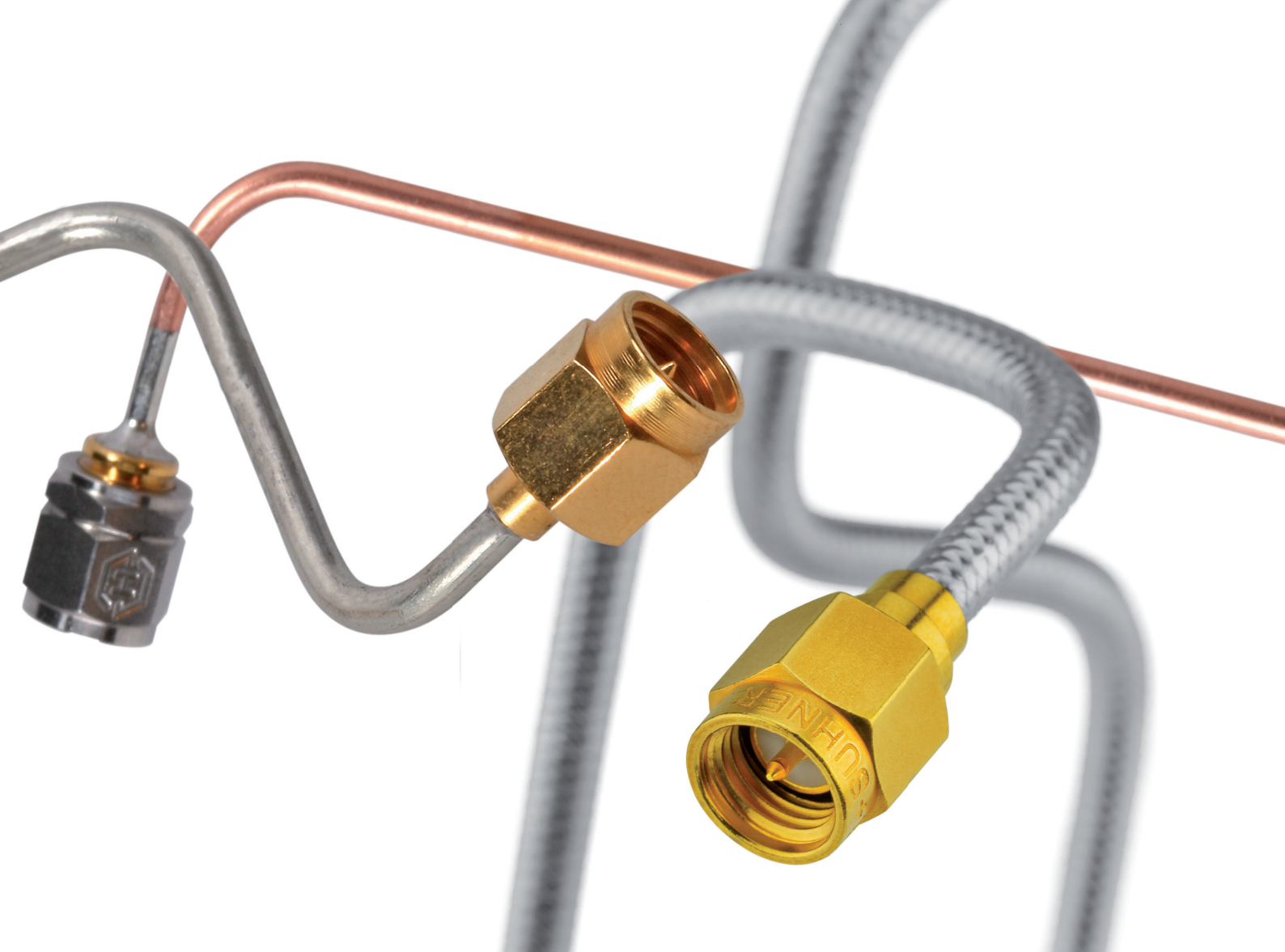

## Handformable and formstable microwave cable assemblies

Sucoform microwave coaxial cables offer distinct mechanical advantages over semi-rigid cables. They are based on the same design as the standard PTFE insulated semi-rigid cables, but have a tin-soaked copper braid for the outer conductor, giving them outstanding hand-formability. These cables combine the excellent characteristics of semi-rigid cables with those of flexible coaxial cables. Thanks to their small bending radii, they allow spacesaving routing and packaging.

The semi-rigid cable is unique in that it is easily bent to finished shape and still maintains its set after bending. This property makes it ideal for use with automated bending equipment as well as hand forming by bending tools. The semi-rigid cables provide greatly extended environmental parameters. The cables exhibit highly favourable electrical characteristics, particularly an impedance tolerance as low as 0.5 Ohm for a 0.0141" diameter cable with nominal impedance of 50 Ohm.



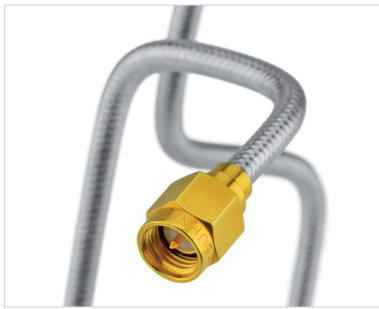

## Sucoform

page 166

The handformable alternative to semi-rigid

- Frequency range up to 40 GHz
- High phase stability
- Good flexibility
- Quick and easy assembling



## Cobra-flex

page 172

The flexible semi-rigid microwave coaxial cable assemblies

- Frequency range up to 40 GHz
- Minimal dielectric migration
- Standard semi-rigid size
- Optional extended temperature range  $-269$  to  $+250$  °C



## Semi-rigid

page 175

The form stable microwave cable

- Frequency range up to 67 GHz
- Excellent VSWR performance
- Easy to form, strip and solder
- Small sizes permit use in high-density areas

# Sucoform

The handformable alternative to semi-rigid

## Product description

Sucoform microwave coaxial cables offer distinct mechanical advantages over semi-rigid cables. They are based on the same design as the standard PTFE insulated semi-rigid cables, but have a tin-soaked copper braid for the outer conductor, giving them outstanding hand-formability. These cables combine the excellent characteristics of semi-rigid cables with those of flexible coaxial cables. Thanks to their small bending radii, they allow space saving routing and packaging.



## Product features

- Impedance 50 Ω
- Applicable up to 40 GHz
- Due to the high phase stability over every production run, Sucoform is especially suitable for delay lines
- Good flexibility: easy hand forming without tooling; fits into the smallest systems
- Quick and easy assembly for design and manufacture

## Recommended connectors

SM_47_CU	MMCX, MCX, SMA, SK
SM_86	MCX, MMCX, SMA, SMB, SMC, PC3.5, SK, QMA, TNC, N
SM_141	SMA, PC3.5, QMA, TNC, N, QN
SM_250-01	SMA, N, 7/16
	Other connectors available on request

## Construction



Cable	Inner conductor ①	Dielectric ②	Outer conductor ③	Outer diameter mm	Screening effectiveness up to 18 GHz dB
SM_47_CU	CuAg Wire	PTFE	Sn soaked Cu braid	1.2	> 90
SM_86	StCuAg Wire	PTFE	Sn soaked Cu braid	2.1	> 90
SM_141	StCuAg Wire	PTFE	Sn soaked Cu braid	3.6	> 90
SM_250-01	CuAg Wire	PTFE	Sn soaked Cu braid	6.4	> 90

Sucoform cables are available with different jackets, inner conductor materials and impedances.

## Technical data

Cable	Item no.	Max. operating frequency	Velocity of propagation	Weight g/m	Min. bending radii		Temperature range °C
		GHz	%		static mm	repeated mm	
SM_47_CU	23033515	40	71	6	3.18	n/a	-65 to +165
SM_86	22511613	40	71	15	6	20	-65 to +165
SM_141	22511925	33	71	38	8	40	-65 to +165
SM_250-01	84007938	18	71	130	30	120	-65 to +165

# Sucoform

Attenuation (nominal values at +25 °C ambient temperature)

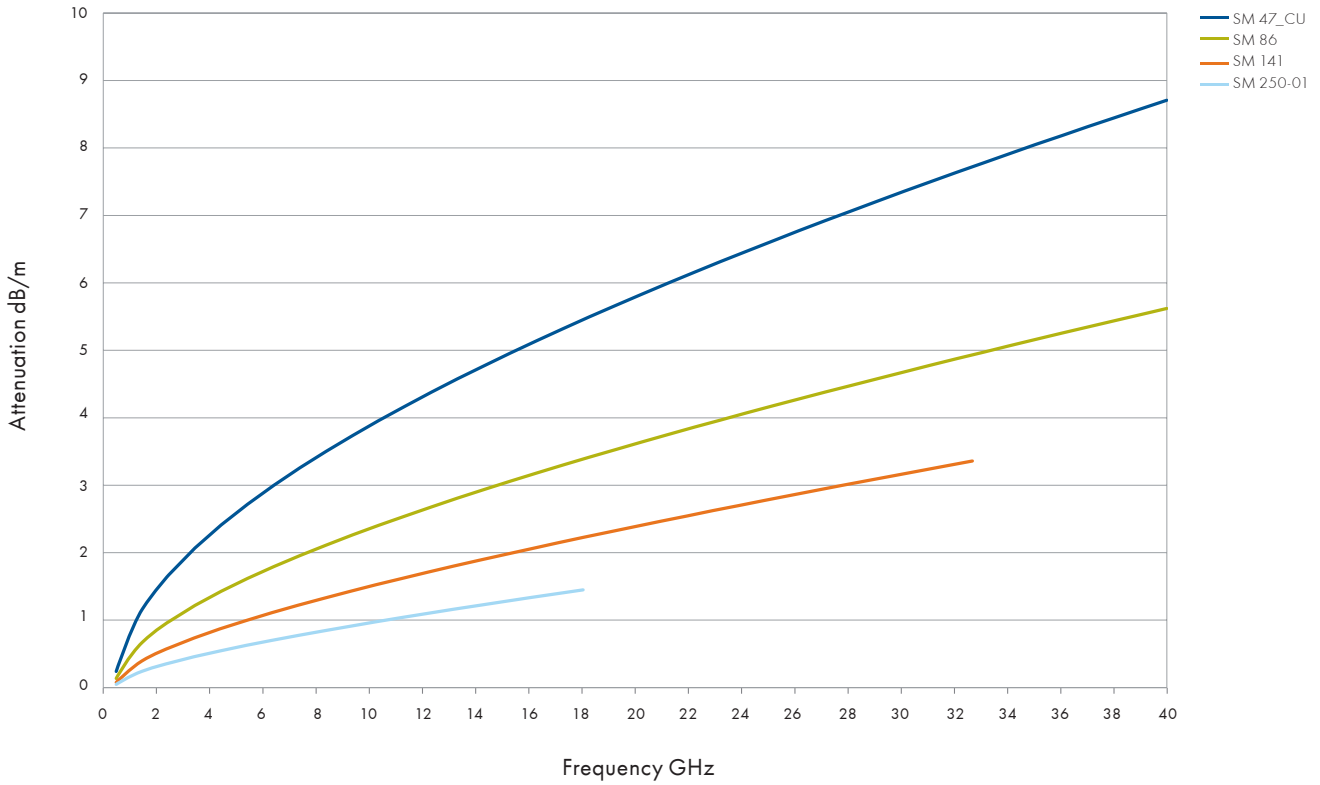

Formstable assemblies

Power handling (maximum values at 25 °C ambient temperature and sea level)

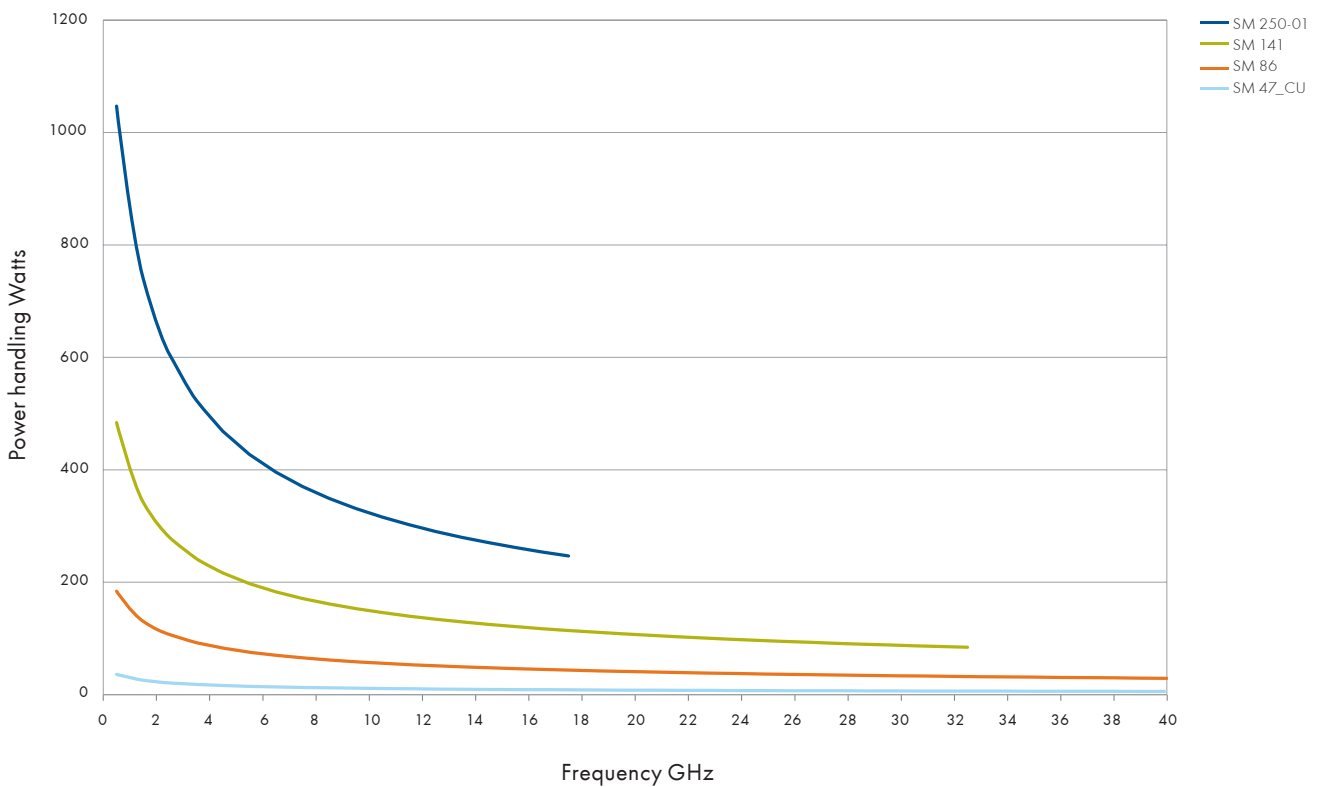

# Sucoform – with protective jacket

## Construction

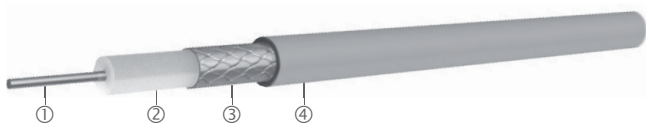

Cable	Inner conductor ①	Dielectric ②	Outer conductor ③	Jacket ④	Outer diameter mm	Screening effectiveness up to 18 GHz dB
SM_47_CU_LSFH	CuAg Wire	PTFE	Sn soaked Cu braid	LSFH	1.7	> 90
SM_86_PE	StCuAg Wire	PTFE	Sn soaked Cu braid	PE	3.2	> 90
SM_86_FEP	StCuAg Wire	PTFE	Sn soaked Cu braid	FEP	2.5	> 90
SM_141_CU_PE	CuAg Wire	PTFE	Sn soaked Cu braid	PE	4.6	> 90
SM_141_CU_FEP	CuAg Wire	PTFE	Sn soaked Cu braid	FEP	4.1	> 90
SM_250-01_FEP	CuAg Wire	PTFE	Sn soaked Cu braid	FEP	6.8	> 90

Sucoform cables are available with different inner conductor materials and impedances.

## Technical data

Cable	Item no.	Max. operating frequency	Velocity of propagation	Weight g/m	Min. bending radii		Temperature range °C
		GHz	%		static mm	repeated mm	
SM_47_CU_LSFH	23035506	40	71	7	4	n/a	-40 to +85
SM_86_PE	22511631	40	71	19	6	20	-40 to +85
SM_86_FEP	22511942	40	71	18	6	20	-65 to +165
SM_141_CU_PE	22511639	33	71	47	8	40	-40 to +85
SM_141_CU_FEP	22512256	33	71	47	8	40	-65 to +165
SM_250-01_FEP	84007941	18	71	138	30	120	-65 to +165

# Sucoform - with protective jacket

Attenuation (nominal values at +25 °C ambient temperature)

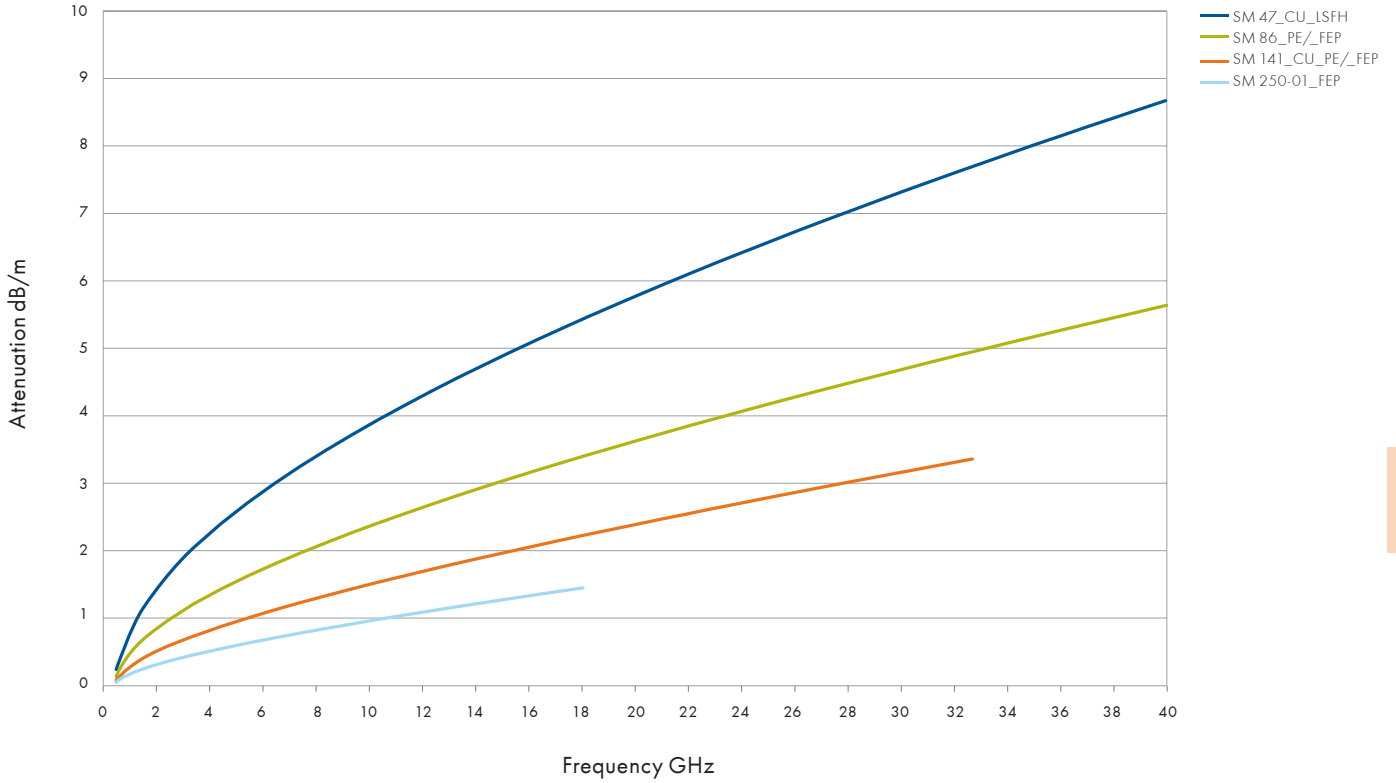

Formstable assemblies

Power handling (maximum values at 25 °C ambient temperature and sea level)

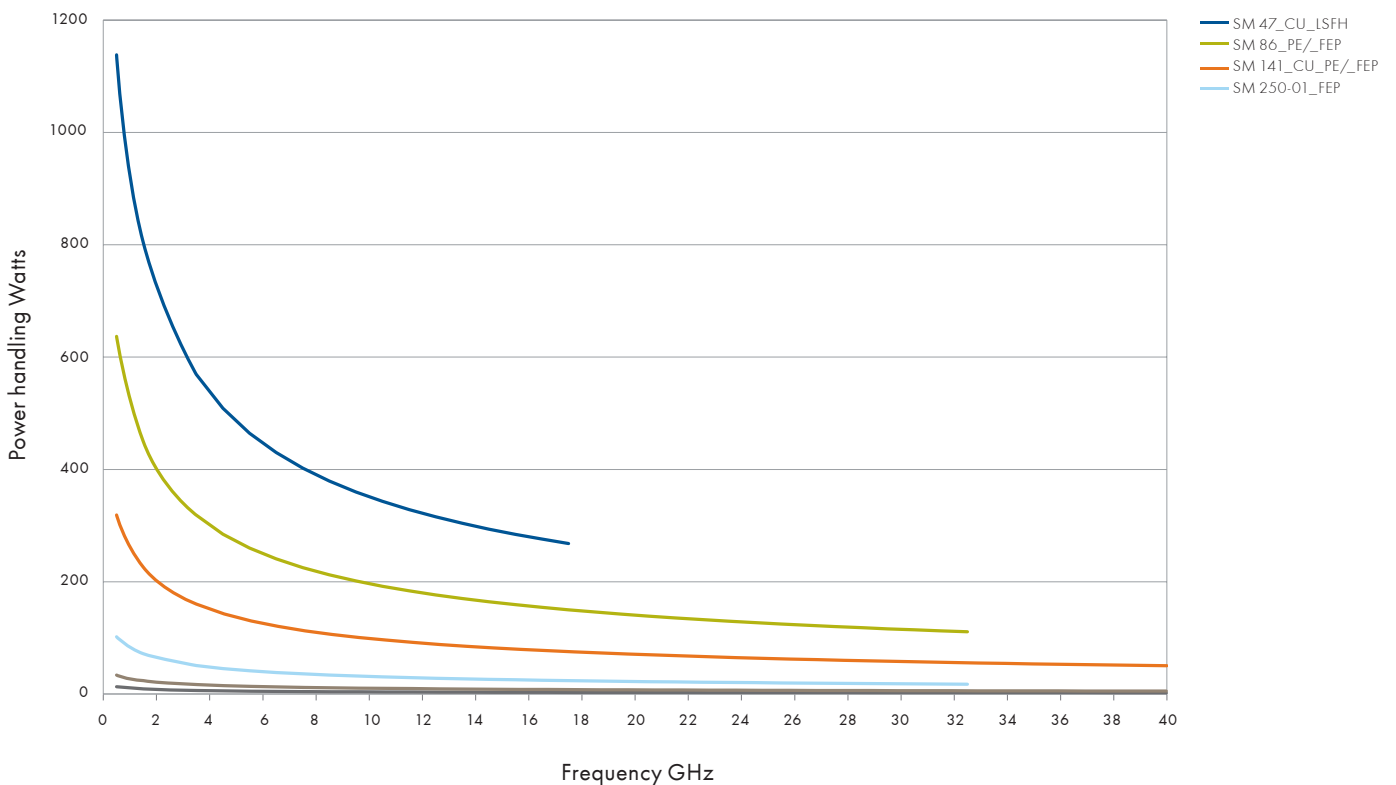

# Sucoform

## Available connectors

Connector	Series, pattern	HUBER+SUHNER type	Cable	Operating frequency GHz	Item no.
MCX	straight cable plug	11_MCX-50-1-14/111_NE	SM_47_CU	6	23032081
	right angle cable plug	16_MCX-50-1-12/111_NE		6	23024694
	straight panel bulkhead cable jack	24_MCX-50-1-3/111_NE		6	22641648
MMCX	straight cable plug	11_MMCX-50-1-3/111_OE	SM_47_CU	6	22648893
	right angle cable plug	16_MMCX-50-1-12/111_OE		6	84030531
	right angle cable plug	16_MMCX-50-1-4/111_OE		6	22649182
	straight panel bulkhead cable jack	24_MMCX-50-1-3/111_OE		6	22652326
SK	straight cable plug	11_SK-50-1-2/119_NE	SM_47_CU	40	84013232
SMA	straight cable plug	11_SMA-50-1-2/111_NE	SM_47_CU	18	22642388
	right angle cable plug	16_SMA-50-1-97/19_NE		18	23024708
	straight cable jack	21_SMA-50-1-2/111_NE		18	22642386
	straight panel bulkhead cable jack	24_SMA-50-1-6/111_YH		18	23025035
MCX	straight cable plug	11_MCX-50-2-19/111_NE	SM_86	6	23024699
	right angle cable plug	16_MCX-50-2-104/111_NH-1		6	23032067
	right angle cable plug	16_MCX-50-2-104/111_NH		6	22658277
	straight panel bulkhead cable jack	24_MCX-50-2-3/111_NE		6	22543580
MMBX	straight cable plug	11_MMBX-50-2-4/111_NE	SM_86	12.4	84026769
	right angle cable plug	16_MMBX-50-2-4/111_NE		12.4	84026740
	straight panel bulkhead cable jack	24_MMBX-50-2-2/111_NH		12.4	23037876
MMCX	straight cable plug	11_MMCX-50-2-1/111_OE	SM_86	6	22645297
	right angle cable plug	16_MMCX-50-2-1/111_OE		6	22645957
	straight cable jack	21_MMCX-50-2-1/111_OE		6	22645290
	straight panel bulkhead cable jack	24_MMCX-50-2-1/111_OE		6	22645954
N	straight cable plug	11_N-50-2-15/113_UE	SM_86	18	22660315
	right angle cable plug	16_N-50-2-9/13_UH		11	23013729
	straight cable jack	21_N-50-2-14/133_NE		18	22642666
	straight panel bulkhead cable jack	24_N-50-2-14/133_NE		18	22544637
	straight panel cable jack, flange mount	25_N-50-2-14/133_NE		18	22641303
PC3.5	straight cable plug	11_PC35-50-2-4/199_UE	SM_86	33	84009440
	straight cable jack	21_PC35-50-2-4/199_UE		33	84009419
	straight panel bulkhead cable jack	24_PC35-50-2-2/199_UE		33	84009405
QMA	straight cable plug	11_QMA-50-2-3/133_NE	SM_86	6	23017704
	right angle cable plug	16_QMA-50-2-3/133_NE		6	23017666
	straight panel bulkhead cable jack	24_QMA-50-2-1/111_NE		6	23017742
SK	straight cable plug	11_SK-50-2-56/119_NE	SM_86	40	84013230
	straight cable jack	21_SK-50-2-58/199_NE		40	84019664
SMA	straight cable plug	11_SMA-50-2-15/111_NE	SM_86	18	22544545
	straight cable plug	11_SMA-50-2-110/133_NE		18	84130715
	right angle cable plug	16_SMA-50-2-43/133_NE		18	22641953
	right angle cable plug	16_SMA-50-2-100/199_NH		26.5	23018813

# Sucoform

Connector	Series, pattern	HUBER+SUHNER type	Cable	Operating frequency GHz	Item no.
SMA	straight cable jack	21_SMA-50-2-15/111_NE	SM_86	18	22544549
	straight panel bulkhead cable jack	24_SMA-50-2-15/111_NE		18	22544532
	straight panel bulkhead cable jack	24_SMA-50-2-41/133_NE		18	22641381
SMB	straight cable plug	11_SMB-50-2-13/111_NE	SM_86	4	22543362
	right angle cable plug	16_SMB-50-2-23/111_NE		4	22644079
	straight panel bulkhead cable jack	24_SMB-50-2-13/111_NE		4	22640822
SMC	straight cable plug	11_SMC-50-2-13/111_NE	SM_86	10	22543363
	right angle cable plug	16_SMC-50-2-25/111_NE		10	22644126
	straight panel bulkhead cable jack	24_SMC-50-2-13/111_NE		10	22640297
TNC	straight cable plug	11_TNC-50-2-20/103_NE	SM_86	11	22642519
	straight panel bulkhead cable jack	24_TNC-50-2-31/133_NE		11	23001721
N	straight cable plug	11_N-50-3-13/113_NE	SM_141	11	22542083
	straight cable plug	11_N-50-3-51/133_NE		18	22543919
	right angle cable plug	16_N-50-3-15/133_NE		11	22648832
	straight cable jack	21_N-50-3-51/19_NE		18	22543922
	straight panel bulkhead cable jack	24_N-50-3-51/19_NE		18	22642344
	straight panel cable jack, flange mount	25_N-50-3-9/133_NE		11	22543952
PC3.5	straight cable plug	11_PC35-50-3-4/199_UE	SM_141	33	84009380
	straight cable jack	21_PC35-50-3-3/199_UE		33	84009382
	straight panel bulkhead cable jack	24_PC35-50-3-2/199_UE		33	84009383
QMA	straight cable plug	11_QMA-50-3-3/133_NE	SM_141	6	23017695
	right angle cable plug	16_QMA-50-3-3/133_NE		6	23017693
	straight panel bulkhead cable jack	24_QMA-50-3-3/111_NE		6	23017683
QN	straight cable plug	11_QN-50-3-3/113_NE	SM_141	11	23033393
	right angle cable plug	16_QN-50-3-3/13_NE		11	23033268
	straight panel bulkhead cable jack	24_QN-50-3-3/13_NE		11	23033423
SMA	straight cable plug	11_SMA-50-3-77/119_NH	EZ_141	18	84005524
	straight cable plug	11_SMA-50-3-235/133_NE		18	84130698
	right angle cable plug	16_SMA-50-3-3/111_NE		18	22640073
	right angle cable plug	16_SMA-50-3-13/133_NE		18	84130707
	straight cable jack	21_SMA-50-3-15/111_NE		18	22544550
	straight panel bulkhead cable jack	24_SMA-50-3-15/111_NE		18	22641153
TNC	straight cable plug	11_TNC-50-3-29/103_NE	EZ_141	11	22641997
	right angle cable plug	16_TNC-50-3-24/13_NE		11	84021420
	straight panel bulkhead cable jack	24_TNC-50-3-30/133_NH		11	23001723
7/16	straight cable plug	11_716-50-5-6/003_Y	SM_250-01	7.5	84008435
	straight panel cable jack, flange mount	25_716-50-5-17/000_Y		7.5	84008881
N	straight cable plug	11_N-50-5-18/103_NH	SM_250-01	11	84008445
	right angle cable plug	16_N-50-5-7/13_-H		7.5	21000191
SMA	straight cable plug	11_SMA-50-5-1/111_NE	SM_250-01	18	22642399

# Cobra-flex

The flexible semi-rigid microwave coaxial cable assemblies

## Product description

cobra-flex is high performance semi-rigid cables which utilise a seamless outer conductor to provide excellent RF shielding. The convoluted design gives this cable excellent phase tracking characteristics over temperature due to minimal dielectric migration. These cables are offered with many options including tin-plated outer conductor, copper clad steel center conductor for low thermal conductivity in cryogenic applications.



## Product features

- Impedance 50 Ω
- Applicable up to 40 GHz
- Minimal dielectric migration
- Higher flexibility without outer conductor fatiguing
- Standard semi-rigid sizes
- Optional extended temperature range -269 to +250 °C for cryogenic applications

## Recommended connectors

31086	SMA, SK, 3.5 mm, TNC, N
31000	SMA, TNC, N, 3.5 mm
31000S	SMA, TNC, N, 3.5 mm

## Construction



Cable	Inner conductor ①	Dielectric ②	Outer conductor ③	Outer diameter mm
31000	CuAg wire	PTFE	StCu tube	3.6
31000S	StCuAg wire	PTFE	StCu tube	3.6
31086	CuAg wire	PTFE	StCu tube	2.2

## Technical data

Cable	Item no.	Replacement for	Max. operating frequency	Velocity of propagation	Weight g/m	Min. bending radii		Temperature range °C
			GHz	%		static mm	repeated mm	
31000	80310897	RG_402	32	70.3	35.7	19.1	57.2	-55 to +200
31000S	80320630		32	70.3	35.7	19.1	57.2	
31086	80310901	RG_405	40	70.3	20.8	8.9	26.7	



# Cobra-flex

Attenuation (nominal values at +25 °C ambient temperature)

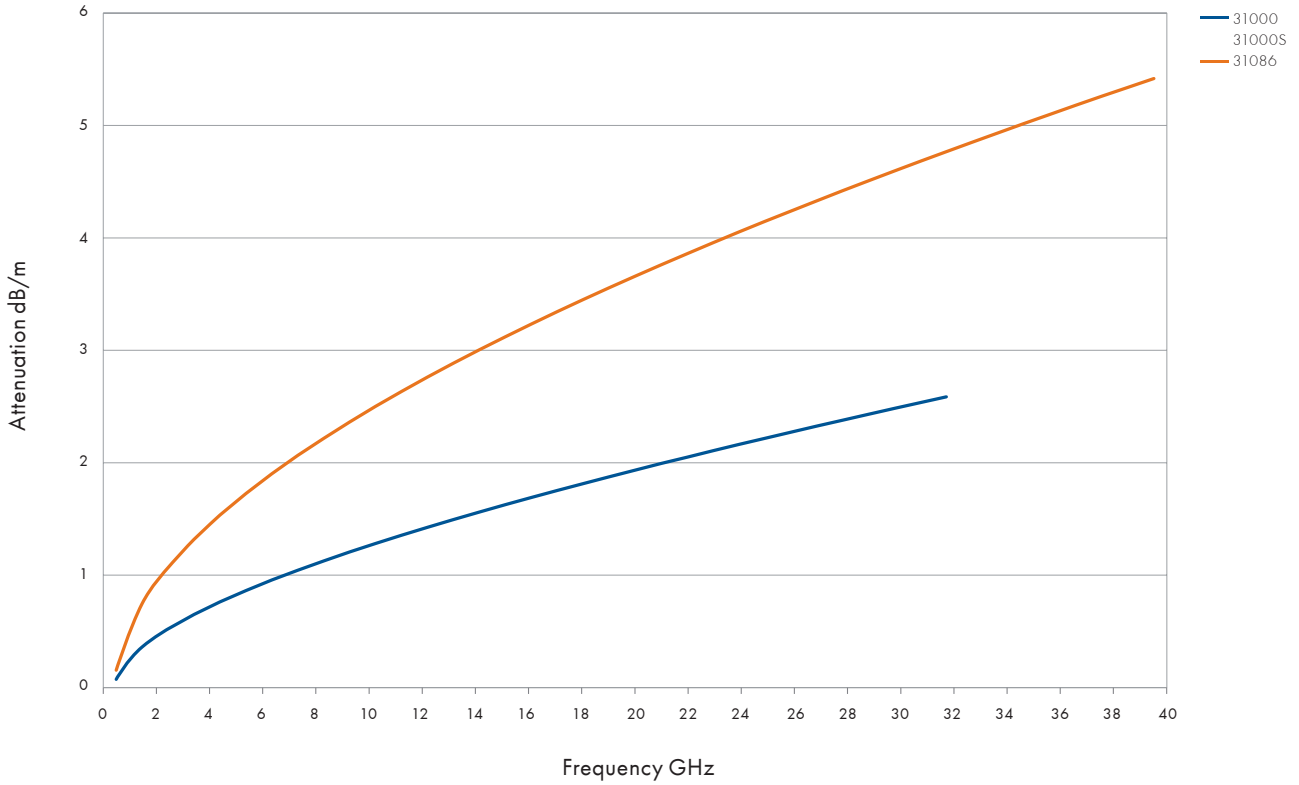

Power handling (maximum values at 25 °C ambient temperature and sea level)

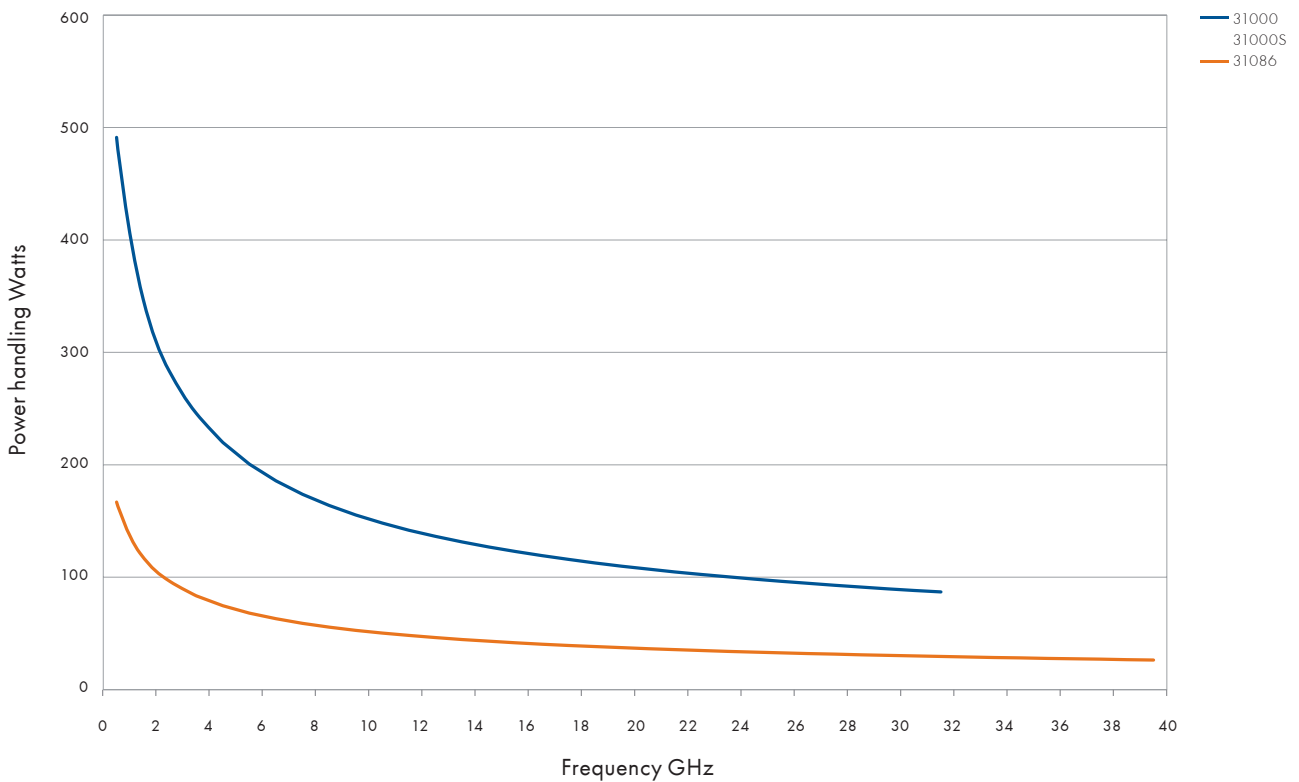

Formstable assemblies

# Cobra-flex

## Available connectors

Connector	Series, pattern	HUBER+SUHNER type	Cable	Operating frequency GHz	Item no.
SMA	straight cable plug	29044-2	31000	26.5	80315306
	straight cable jack	29045-5		25	80315359
	straight cable plug	29043-31	31000S	26.5	80340083
	straight cable jack	29045-5		25	80315359
	straight cable plug	29044-1	31086	26.5	80315299
	straight cable jack	29045-6		25	80315360
SK	straight cable jack	29045K-1	31086	30	80363345
3.5 mm	straight cable plug	29802-1	31000	26.5	80319751
	straight cable jack	29803-1		26.5	80319756
	straight bulkhead cable jack	29803F-1		26.5	80319758
	straight cable plug	29802-1	31000S	26.5	80319751
	straight cable jack	29803-1		26.5	80319756
	straight bulkhead cable jack	29803F-1		26.5	80319758
	straight cable plug	29802-2	31086	26.5	80319752
	straight cable jack	29803-2		26.5	80319757
	straight bulkhead cable jack	29803F-2		26.5	80319759
TNC	straight cable plug	29714-1	31000	15	80319117
	straight bulkhead cable jack	29320-1		15	80317410
	straight bulkhead precision cable jack	29320P-1		18	80340472
	straight cable plug	29714-1	31000S	15	80319117
	straight cable jack	29320-1		15	80317410
	straight bulkhead precision cable jack	29320P-1		18	80340472
	straight precision cable plug	29714-2	31086	15	80319122
N	straight cable plug	29080-1	31000	18	80315810
	straight bulkhead cable jack	29082P-1		18	80316012
	straight cable plug	29080-1	31000S	18	80315810
	straight bulkhead cable jack	29082P-1		18	80316012
	straight cable plug	29080-2	31086	18	80315825

# Semi-rigid

The copper form stable microwave cable

## Product description

The semi-rigid cable is unique in that it is easily bent to finished shape and still maintains its set after bending. This property makes it ideal for use with automated bending equipment as well as hand forming by bending tools.

## Product features

- Impedance 50 Ω
- Applicable up to 67 GHz
- Excellent VSWR performance
- Easy to form, strip and solder, making for convenient installation
- Small sizes permit use in high-density areas



## Recommended connectors

EZ_47	MMCX, MCX, SMA, SK
EZ_86	MCX, MMCX, SMA, PC3.5, SK, QMA, TNC, N
EZ_118	SK
EZ_141	SMA, PC3.5, QMA, TNC, N, QN
EZ_250	SMA, N, 7/16
	Other connectors available on request.

## Construction



Cable	Inner conductor ①	Dielectric ②	Outer conductor ③	Outer Diameter mm	Screening effectiveness up to 18 GHz dB
EZ_47_TP_M17	StCuAg Wire	PTFE	CuSn tube	1.2	> 90
EZ_86_TP_M17	StCuAg Wire	PTFE	CuSn tube	2.2	> 90
EZ_118_TP	StCuAg Wire	PTFE	CuSn tube	3.0	> 90
EZ_141_TP_M17	StCuAg Wire	PTFE	CuSn tube	3.6	> 90
EZ_250_TP_M17	CuAg Wire	PTFE	CuSn tube	6.4	> 90

Other semi rigid cables available on request (e.g. other impedances, other conductor materials).  
Standard form of bulk delivery = 100 ft coils (30.48 m), shorter lengths on request.

## Technical data

Cable	Item no.	Max. operating frequency	Velocity of propagation	Weight g/m	Min. bending radius		Temperature range °C
		GHz	%		static mm	repeated mm	
EZ_47_TP_M17	22810504	67	69.5	7.1	3.18	n/a	-40 to +100
EZ_86_TP_M17	22810175	67	69.5	24	3.18	n/a	-40 to +125
EZ_118_TP	22810073	40	80.0	34	9.53	n/a	-40 to +125
EZ_141_TP_M17	22810043	33	69.5	52	6.35	n/a	-40 to +125
EZ_250_TP_M17	22810705	18	69.5	158	19.0	n/a	-40 to +90

# Semi-rigid

The aluminium form stable microwave cable

## Product description

The semi-rigid cable is unique in that it is easily bent to finished shape and still maintains its set after bending. This property makes it ideal for use with automated bending equipment as well as hand forming by bending tools.

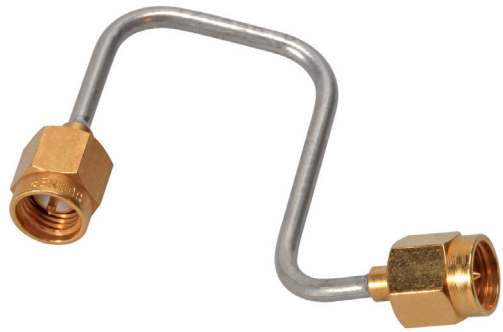

## Product features

- Impedance 50 Ω
- Applicable up to 67 GHz
- Excellent VSWR performance
- Easy to form, strip and solder, making for convenient installation
- Small sizes permit use in high-density areas

## Recommended connectors

EZ_47	MMCX, MCX, SMA, SK
EZ_86	MCX, MMCX, SMA, PC3.5, SK, QMA, TNC, N
EZ_118	SK
EZ_141	SMA, PC3.5, QMA, TNC, N, QN
EZ_250	SMA, N, 7/16
	Other connectors available on request.

## Construction



Cable	Inner conductor ①	Dielectric ②	Outer conductor ③	Outer diameter	Screening effectiveness up to 18 GHz
				mm	dB
EZ_47_AL_TP_M17	StCuAg Wire	PTFE	AlSn tube	1.2	> 90
EZ_86_AL_TP_M17	StCuAg Wire	PTFE	AlSn tube	2.2	> 90
EZ_141_AL_TP_M17	StCuAg Wire	PTFE	AlSn tube	3.6	> 90
EZ_250_AL_TP_M17	CuAg Wire	PTFE	AlSn tube	6.4	> 90

Other semi rigid cables available on request (e.g. other impedances, other conductor materials).  
Standard form of bulk delivery = 100 ft coils (30.48 m), shorter lengths on request.

## Technical data

Cable	Item no.	Max. operating frequency	Velocity of propagation	Weight	Min. bending radius		Temperature range
		GHz	%		static mm	repeated mm	
EZ_47_AL_TP_M17	22810510	67	69.5	3.1	1.27	n/a	-40 to +100
EZ_86_AL_TP_M17	22810167	67	69.5	11.9	1.78	n/a	-40 to +125
EZ_141_AL_TP_M17	22810015	33	69.5	30.5	3.18	n/a	-40 to +125
EZ_250_AL_TP_M17	22810708	18	69.5	88.6	19.0	n/a	-40 to +90

# Semi-rigid

Attenuation (nominal values at +25 °C ambient temperature)

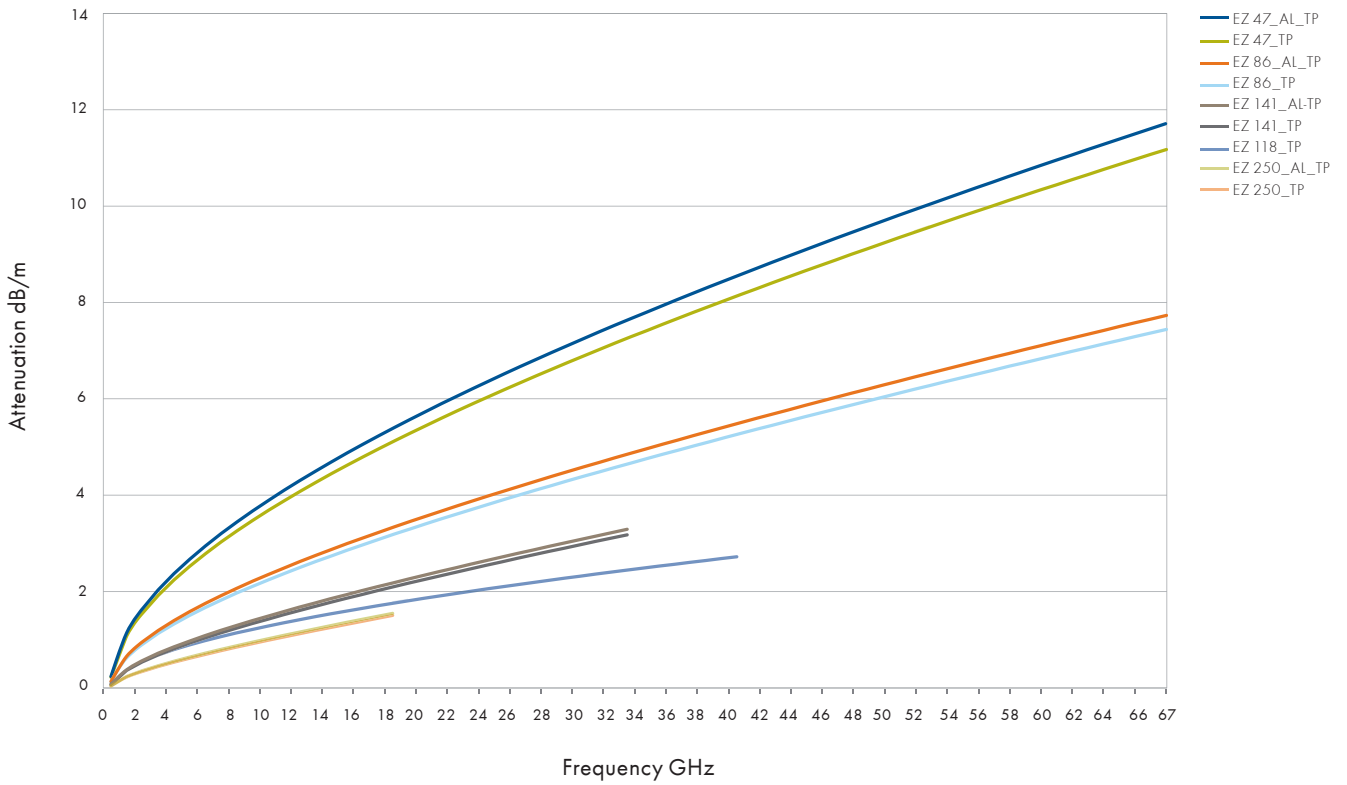

Formstable assemblies

Power handling (maximum values at 25 °C ambient temperature and sea level)

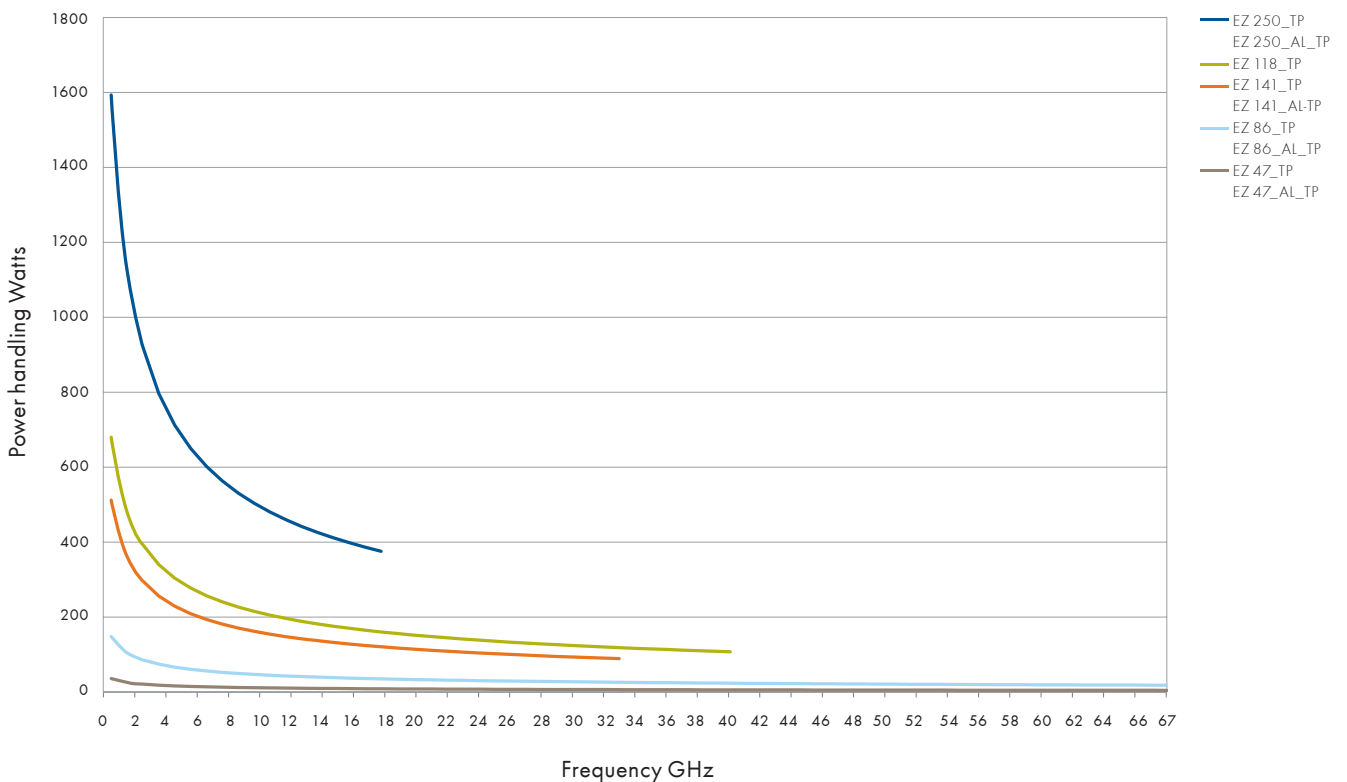

# Semi-rigid

## Available connectors

Connector	Series, pattern	HUBER+SUHNER type	Cable	Operating frequency GHz	Item no.
MCX	straight cable plug	11_MCX-50-1-14/111_NE	EZ_47	6	23032081
	right angle cable plug	16_MCX-50-1-11/111_NE		6	23024700
	straight panel bulkhead cable jack	24_MCX-50-1-3/111_NE		6	22641648
MMCX	straight cable plug	11_MMCX-50-1-3/111_OE	EZ_47	6	22648893
	right angle cable plug	16_MMCX-50-1-4/111_OE		6	22649182
SK	straight cable plug	11_SK-50-1-2/119_NE	EZ_47	40	84013232
SMA	straight cable plug	11_SMA-50-1-53/119_NH	EZ_47	18	23013327
	right angle cable plug	16_SMA-50-1-97/19_NE		18	23024708
	straight cable jack	21_SMA-50-1-2/111_NE		18	22642386
	straight panel bulkhead cable jack	24_SMA-50-1-6/111_YH		18	23025035
MCX	straight cable plug	11_MCX-50-2-19/111_NE	EZ_86	6	23024699
	right angle cable plug	16_MCX-50-2-104/111_NH-1		6	23032067
	right angle cable plug	16_MCX-50-2-104/111_NH		6	22658277
	straight panel bulkhead cable jack	24_MCX-50-2-3/111_NE		6	22543580
MMCX	straight cable plug	11_MMCX-50-2-1/111_OE	EZ_86	6	22649039
	right angle cable plug	16_MMCX-50-2-1/111_OE		6	22645957
	straight cable jack	21_MMCX-50-2-1/111_OE		6	22645290
	straight panel bulkhead cable jack	24_MMCX-50-2-1/111_OE		6	22645954
N	straight cable plug	11_N-50-2-15/113_UE	EZ_86	18	22660315
	right angle cable plug	16_N-50-2-9/13_UH		11	23013729
	straight cable jack	21_N-50-2-14/133_NE		18	22642666
	straight panel bulkhead cable jack	24_N-50-2-14/133_NE		18	22544637
PC3.5	straight cable plug	11_PC35-50-2-4/199_UE	EZ_86	33	84009440
	straight cable jack	21_PC35-50-2-4/199_UE		33	84009419
	straight panel bulkhead cable jack	24_PC35-50-2-2/199_UE		33	84009405
QMA	straight cable plug	11_QMA-50-2-3/133_NE	EZ_86	6	23017704
	right angle cable plug	16_QMA-50-2-3/133_NE		6	23017666
	straight panel bulkhead cable jack	24_QMA-50-2-1/111_NE		6	23017742
SK	straight cable plug	11_SK-50-2-56/119_NE	EZ_86	40	84013230
SMA	straight cable plug	11_SMA-50-2-15/111_NE	EZ_86	18	22544545
	straight cable plug	11_SMA-50-2-110/133_NE		18	84130715
	right angle cable plug	16_SMA-50-2-43/133_NE		18	22641953
	right angle cable plug	16_SMA-50-2-100/199_NH		26.5	23018813
	straight cable jack	21_SMA-50-2-15/111_NE		18	22544549
	straight panel bulkhead cable jack	24_SMA-50-2-15/111_NE		18	22544532
	straight panel bulkhead cable jack	24_SMA-50-2-41/133_NE		18	22641381
TNC	straight cable plug	11_TNC-50-2-20/103_NE	EZ_86	11	22642519
	straight panel bulkhead cable jack	24_TNC-50-2-31/133_NE		11	23001721

# Semi-rigid

Connector	Series, pattern	HUBER+SUHNER type	Cable	Operating frequency GHz	Item no.
SK	straight cable plug	11_SK-50-2-51/119_NE	EZ_118	40	22645972
	straight cable jack	21_SK-50-2-51/199_NE		40	22645973
	straight panel bulkhead cable jack	24_SK-50-2-55/1--_NE		40	84016419
N	straight cable plug	11_N-50-3-13/113_NE	EZ_141	11	22542083
	straight cable plug	11_N-50-3-51/133_NE		18	22543919
	right angle cable plug	16_N-50-3-15/133_NE		11	22648832
	straight cable jack	21_N-50-3-51/19-_NE		18	22543922
	straight panel bulkhead cable jack	24_N-50-3-51/19-_NE		18	22642344
PC3.5	straight cable plug	11_PC35-50-3-4/199_UE	EZ_141	33	84009380
	straight cable jack	21_PC35-50-3-3/199_UE		33	84009382
	straight panel bulkhead cable jack	24_PC35-50-3-2/199_UE		33	84009383
QMA	straight cable plug	11_QMA-50-3-3/133_NE	EZ_141	6	23017695
	right angle cable plug	16_QMA-50-3-3/133_NE		6	23017693
	straight panel bulkhead cable jack	24_QMA-50-3-3/111_NE		6	23017683
QN	straight cable plug	11_QN-50-3-3/113_NE	EZ_141	11	23033393
	right angle cable plug	16_QN-50-3-3/13-_NE		11	23033268
	straight panel bulkhead cable jack	24_QN-50-3-3/13-_NE		11	23033423
SMA	straight cable plug	11_SMA-50-3-77/119_NH	EZ_141	18	84005524
	straight cable plug	11_SMA-50-3-235/133_NE		18	84130698
	right angle cable plug	16_SMA-50-3-3/111_NE		18	22640073
	right angle cable plug	16_SMA-50-3-13/133_NE		18	84130707
	straight cable jack	21_SMA-50-3-15/111_NE		18	22544550
	straight panel bulkhead cable jack	24_SMA-50-3-15/111_NE		18	22641153
TNC	straight cable plug	11_TNC-50-3-29/103_NE	EZ_141	11	22641997
	right angle cable plug	16_TNC-50-3-24/13-_NE		11	84021420
	straight panel bulkhead cable jack	24_TNC-50-3-30/133_NH		11	23001723
7/16	straight cable plug	11_716-50-5-6/003_Y	EZ_250	7.5	84008435
	straight panel cable jack, flange mount	25_716-50-5-17/000_Y		7.5	84008881
N	straight cable plug	11_N-50-5-18/103_NH	EZ_250	11	84008445
	straight cable plug	11_N-50-5-39/133_NE		18	22642481
	straight panel bulkhead cable jack	24_N-50-5-39/133_NE		18	22642505
SMA	straight cable plug	11_SMA-50-5-1/111_NE	EZ_250	18	22642399
	straight cable plug	11_SMA-50-5-2/199_NE		18	22643253
	straight cable jack	21_SMA-50-5-2/199_NE		18	22643643

# Engineering information

## General cable design criteria

Microwave transmission lines are used to transmit electromagnetic energy in a controlled manner. In contrast to ordinary circuit theory where resistance (R), capacitance (C), conductance (G) and inductance (L) are represented as lumped constant elements, the R, C, G, and L of microwave transmission lines are considered distributed parameters. Hence, the microwave transmission line is a distributed element circuit. The electrical length of the microwave transmission line is a function of the physical length and the Velocity of Propagation. The principal mode of propagation in a coaxial microwave transmission line is the (TEM) Transverse Electro Magnetic mode. This means that the electromagnetic field has only radial components which include the vector electric field (E) and the vector magnetic field (H). TEM can exist in all transmission lines with two or more conductors or in free space. As the frequency increases, the wavelength will decrease. Therefore, the internal dimensions must be proportionally reduced for mode-free propagation in the TEM mode. If frequency increases and the internal radial dimensions remain constant, the next higher order mode may exist. This second mode in the coaxial line is transverse electric mode TE<sub>11</sub>. In coaxial microwave transmission lines, the TEM mode propagation is preferred because a second mode may cause resonance. A coaxial line may be used at frequencies that are slightly higher than the theoretical cutoff because the cutoff frequency does not mean that resonance will occur, it only means the possibility of resonance.

One of the first things to consider when selecting or designing a coaxial cable is determining the temperature requirements. The dielectric materials selected for the outer jacket and inner core are some of the limiting factors affecting the allowable temperature range.

Cable style (high flexibility, low flexibility or semi-rigid) should be the next determination. Some applications are able to use any of these styles. Since many flexible cables perform to the level of semi-rigid, and have a similar cost to semi-rigid, then the cost of installation should be considered.

High flexibility cables require a careful selection of materials and construction to ensure a long flex life.

For low loss applications, a solid center conductor is usually preferred. However, a solid center conductor may limit flexibility and is not always the most cost effective for larger diameter cables.

Consider the cost limitations at all times when selecting a cable style or design. Overdesign of a cable may drive the cost unnecessarily high. A lower cost cable may appear to meet the requirements initially, but take care to consider the weaknesses of each individual style. For example, additional armor can be supplied over most cable assemblies to provide extra protection, however, it is costly.

In conclusion, specific requirements must be carefully considered with regard to the selection of cable and cable assemblies including but not limited to the frequency range, VSWR, insertion loss, mechanical and electrical requirements along with any environmental or application restrictions. A thoughtful and precise review of requirements will result in an optimal design.

## Impedance

When "impedance" is mentioned in reference to coaxial cables, the "characteristic impedance" is normally implied. Characteristic impedance ( $Z_0$ ) is the ratio of voltage to current in a travelling wave. In low loss coaxial cable, the impedance is directly related to the logarithm of the ratio of the inner and outer diameters, and inversely related to the square root of dielectric constant of the core material. In a low loss coaxial cable, the impedance is always a positive real number. Maximum power transfer results only when the characteristic impedance of the transmitter, RF line, and the receiver (or antenna) are equal to each other or the complex conjugate. If the match is exact, losses are only due to the attenuation of the transmission line. If there is a mismatch, reflection losses will result.

$$Z_0 \text{ (ohms)} = \left[ 138 / \sqrt{\epsilon_r} \right] \times (\log_{10} D/d)$$

**d** = center conductor diameter in inches

**D** = dielectric core diameter in inches

## Velocity of propagation

Velocity of propagation is the speed of signal transmission relative to the speed of light. Since it is inversely proportional to the square root of the dielectric constant, a lower dielectric constant will result in an increase in velocity. Velocity of propagation is expressed as a percentage of the speed of light in a vacuum and can be calculated by the following formula:

$$V_p \text{ (\%)} = \left( 1 / \sqrt{\epsilon_r} \right) \times 100$$

## Delay

Delay time is defined as the duration between the time a signal enters a coaxial line until it emerges from the other end of a coaxial line. The delay time is essentially independent of frequency and is a function of the dielectric constant and the physical length of the transmission line. Delay time is typically indicated in nanoseconds ( $10^{-9}$  seconds) per foot.

$$\text{Delay} = T_{ns} = 1.0167 \sqrt{\epsilon_r}$$



# Engineering information

## Dielectric constant at 3 GHz, 25 °C

Air	1.00
Ceramic steatite	5.70
Glass, borosilicate (Kovar sealing)	4.90
Nylon	2.84
Polyethylene (solid)	2.26
Polyethylene (foamed)	1.20 - 1.55
Polypropylene	2.55
Polystyrene	2.55
Polystyrene, cross-linked	2.58
Polystyrene, foamed 0.25% filler	1.03
Polytetrafluoroethylene (solid teflon)	2.03
Polytetrafluoroethylene (low density)	1.2 - 1.60
Porcelain	5.04
Rubber, butyl	2.35
Rubber, neoprene	4.00
Rubber, silicone	3.13
Fluoroloy H	2.43
9010 corning glass	6.3
9013 corning glass	6.65
Noryl	2.55
K-50	2.60
Ultem	3.05

1. Number of shields: flat braid, round braid and helical wrap
2. Braid style and coverage: a flat braid is usually better than a round braid and a higher percentage of braid coverage normally provides better shielding.
3. Thickness of shield materials and plating of the conductor: cable outer conductors are typically silver plated.
4. Connector and style of attachment: the best shielded connector typically uses a threaded coupling nut with a slotless outer conductor attached to the cable by clamping, soldering or crimping with minimal amount of outer conductor junctions.

## Capacitance

Capacitance is the property which permits electrical energy to be stored in a dielectric between two conductors that are at different potentials. Similar to impedance, capacitance is dependent upon the inner and outer conductor dimensional ratio and the dielectric constant, but in a reciprocal way. For example, in cables with the same dielectric constant, if capacitance decreases then impedance increases. The capacitance of a cable is expressed in picofarads ( $10^{-12}$  farad) per foot, and can be calculated with the following formula:

$$C_{pf/ft} = 7.354 \epsilon_r / \log_{10} (D/d)$$

## Shielding

The shielding effectiveness of a coaxial cable depends on the construction of its outer conductors. Generally, the shielding efficiency is measured by the relative level of the signal leaking from the outer conductor in decibels per one foot of the length. The effectiveness of shielding on microwave cables usually diminishes with increased frequency. In practice, the shielding efficiency of semi-rigid (solid sheath) cables is limited by the leakage of the connectors and the cable/connector junction. Some factors which influence the shielding effectiveness of flexible cable assemblies are:

# Engineering information

## VSWR/return loss conversion

Reflection can be estimated by reflection coefficient, which is the ratio of reflected wave voltage (current) to incident wave voltage (current). Reflection coefficient has a magnitude and phase and can be represented by complex numbers. Another parameter for reflection is voltage standing wave ratio (VSWR). VSWR is defined from the magnitude of reflection coefficient and, therefore, does not have a phase. Return loss compares the power in the reflected wave with that in the forward wave. The unit for return loss is decibel. Return loss can be calculated from VSWR and vice-versa.

## VSWR to return loss

VSWR	Reflection coefficient	Return loss dB	Return loss dB	Reflection coefficient	VSWR
1.01	0.0050	46.06	40	0.0100	1.020
1.02	0.0099	40.09	39	0.0112	1.023
1.03	0.0148	36.61	38	0.0126	1.026
1.04	0.0196	34.15	37	0.0141	1.029
1.05	0.0244	32.26	36	0.0158	1.032
1.06	0.0291	30.71	35	0.0178	1.036
1.07	0.0338	29.42	34	0.0200	1.041
1.08	0.0385	28.30	33	0.0244	1.046
1.09	0.0431	27.72	32	0.0251	1.052
1.10	0.0476	26.44	31	0.0282	1.058
1.11	0.0521	25.66	30	0.0316	1.065
1.12	0.0566	24.94	29	0.0355	1.074
1.13	0.0610	24.29	28	0.0398	1.083
1.14	0.0654	23.69	27	0.0447	1.094
1.15	0.0698	23.13	26	0.0501	1.106
1.16	0.0741	22.61	25	0.0562	1.119
1.17	0.0783	22.12	24	0.0631	1.135
1.18	0.0826	21.66	23	0.0708	1.152
1.19	0.0868	21.23	22	0.0794	1.173
1.20	0.0909	20.83	21	0.0891	1.196
1.21	0.0950	20.44	20	0.1000	1.222
1.22	0.0991	20.08	19	0.1122	1.253
1.23	0.1031	19.73	18	0.1259	1.288
1.24	0.1071	19.40	17	0.1413	1.329
1.25	0.1111	19.08	16	0.1585	1.377
1.26	0.1150	18.78	15	0.1778	1.433
1.27	0.1189	18.49	14	0.1995	1.499
1.28	0.1228	18.22	13	0.2239	1.577
1.29	0.1266	17.95	12	0.2512	1.671
1.30	0.1304	17.69	11	0.2818	1.785

## Power handling of RF coaxial assemblies

Two potential failure modes must be considered when determining the power handling capability of an RF coaxial cable:

- Peak power (voltage breakdown)
- Average or CW power

The **peak power** (voltage breakdown) occurs when the voltage gradient between the cable center conductor exceeds a limiting value causing the signal to arc across the path of the least resistance. Generally, the path of the least resistance is located at the cable/connection junction. Catastrophic breakdown is not the only problem: the existence of corona, usually around the center conductor, produces other deleterious effects. Corona cutting is a concern with PTFE insulators whereupon the PTFE is eroded causing the formation of cavities (usually without carbonisation).

Coaxial cable assemblies are typically rated with the peak power handling much lower than what the interface can handle. To maximise peak power of the cable assembly, a high voltage (HV) connector should be used. A higher voltage potential is achieved by overlapping the dielectric thereby increasing the airline arc path. A drawback to this design is that connectors which are modified in this way generally have greater VSWR at higher frequencies.

If the transmission line has reflections, the voltage and the current along the line will have maximums and minimums. The cause of this nonuniform distribution is superposition of the incident and reflected waves. Breakdown is a function of the maximum voltage. Higher reflection results in lower voltage handling. Even high-performance assemblies with low VSWR can have poor peak power handling if they are connected to an unmatched load. Peak power handling is dependent on frequency since the typical value of VSWR is proportional to the increase in frequency. The most common breakdown at high altitudes (usually greater than 70 000 ft) is ionisation breakdown in the air path. For vacuum and space applications, the main type of breakdown is multipaction breakdown. For **average power** rating of a cable with a pulsed signal, multiply the **peak power** rating by the **duty cycle**.

Frequency range, ambient temperature, altitude, physical size, and the thermal properties of each layer of construction are the primary factors which determine the average power handling capability of an RF coaxial cable. The **average power** failure occurs when the level of power transmitted results in resistive and dielectric heating at a rate higher than the rate at which the heat can be conducted away through the different layers of cable and dissipated from the outermost cable layer to the

# Engineering information

environment. A buildup of heat energy causes the internal cable temperature to exceed the maximum rated dielectric temperature. Convection, conduction and radiation are methods to remove heat from the cable assembly. Conduction transfer of heat through the outer and inner conductors of a cable is particularly effective for short assemblies. For very high altitudes and space applications, the air is too thin or nonexistent and convection cooling is ineffective. Heat from the cable assembly can only be removed by radiant heat and conduction.

HUBER+SUHNER has developed a unique computer-modeling program that accurately predicts the power rating for coaxial cables of varying designs and materials. Power handling is calculated for convection cooling only. Conduction and radiation are included in the safety margins. These charts provide the CW or average power rating for all cables versus frequency. The following calculation shows how to use the CW power charts for non-standard temperature conditions:

### Where:

- P = power at temp, t1 and altitude a1
- Ft = temperature derating factor at temp. t1
- Fa = altitude derating factor at altitude a1
- Pf = power level at frequency f1

### Example:

What is the average power rating for HUBER+SUHNER 32051 cable at 12 GHz at an ambient temperature of 100 °C and an altitude of 30 000 ft?

- Pf = 580 Watts (see data - page 122)
- Ft = 0.58 (see chart)
- Fa = 0.68 (see chart)

### Therefore:

$$P = 580 (0.58)(0.68) = 229 \text{ Watts}$$

### Altitude derating factor for RF power

Altitude ft	fa avg	fa peak
Sea level	1	1
10 000	0.90	0.5
20 000	0.79	0.2
30 000	0.68	0.14
40 000	0.58	0.10
50 000	0.48	0.08
60 000	0.38	0.06
70 000	0.29	0.05

### Temperature derating factor for RF average power

Ambient °C	ft
25°	1
50°	0.83
85°	0.66
100°	0.58
125°	0.43
150°	0.28
200°	0.15

Note: Derating factors are calculated for convection only.

### Multipaction and ionisation breakdown

Multipactor breakdown is a failure mode of an RF component that only occurs under conditions of high vacuum, where a certain frequency distance product condition exists between the inner and outer conductors and where a sufficiently large RF electric field strength exists. In a high vacuum environment, an electron may have a free path longer than the electrode separation distance. When this electron collides with the electrode it may release secondary electrons. If both frequency and the distance between inner and outer conductor are favorable, the secondary electrons will be accelerated by the electromagnetic field. Large electron densities rapidly build up and breakdown results. At very low and very high frequencies multipactor breakdown is impossible. Multipactor breakdown can also occur between the conductor and the insulator. A multipactor discharge itself adsorbs little power, but once initiated it can cause increased outgassing from materials within components, which may lead to a gas discharge and total failure. To prevent this event, the microwave components should have vent holes of sufficient size to allow the gasses to escape at a known rate. Multipactor breakdown also results in increased heating within the cable or connector, noise generation, harmonic distortion and intermodulation (when multiple frequency RF signals are applied).

For every vacuum application the power handling should be calculated individually. The worst frequencies for multipactor breakdown are between 500 MHz and 2.5 GHz. At low voltage levels (less than 20 V) and low average power (less than 8 W), multipactor breakdown is theoretically impossible.

In ionisation breakdown, secondary electrons are produced through collisions between electrons and gas molecules. Ionisation breakdown occurs at pressures higher than those for multipaction. Like multipactor breakdown, ionisation breakdown is not possible at very low and very high frequencies and low power levels.

# Engineering information

However, ionisation breakdown is considerably more complex than multipactor breakdown because of the additional dependence on pressure and the type of gas (if other than air).

HUBER+SUHNER has designed, manufactured and delivered several high performance cable assemblies for use in high power, high altitude and space environments. These products were tested by an independent laboratory to determine if any failures due to ionisation and/or multipactor breakdown would occur.

## Connector power handling

The primary factor restricting power handling in the coaxial adaptor or connector is overheating due to restricted heat dissipation. High power cable assemblies, in general, should not exceed 200 °C, however dielectric materials used in precision connector interfaces like 7 mm and 3.5 mm are only rated to 90 °C. HUBER+SUHNER manufactures a high temperature precision bead for high power applications. The maximum temperature usually occurs on the connector inner conductor. When connectors are employed in a coaxial cable assembly, the connector should have a center conductor diameter that is equal to or larger than the cable center conductor diameter in order to maximize the power handling of the assembly.

Although many applications support the use of standard connectors and coaxial transmission lines, recent designs in TWT's, high power filters and high power test equipment have placed a great burden on standard coaxial cable assemblies. Since the internal configuration of the connector termination is a major contributor to heat buildup, HUBER+SUHNER employs a unique dielectric material known as Fluoroloy H® inside connectors used for high power applications. This material has a slightly higher dielectric constant (compared to standard Teflon® dielectric) but has a higher rate of thermal conductivity which allows the heat that is generated in the center conductor to transfer to the outer conductor more rapidly, thus increasing the power handling capability of the connector or adaptor. The majority of HUBER+SUHNER connectors and adaptors can be produced with Fluoroloy H® dielectric upon request. In addition, HUBER+SUHNER can design special customised high power interfaces that are mechanically and electrically compatible with standard interfaces. Contact HUBER+SUHNER sales department regarding any high power requirements.

Note: Teflon® is a trademark of Dupont; Fluoroloy H® is a registered trademark of Saint Gobain Corp.

## Power conversion chart

dBm	mW	dBm	mW	dBm	mW	dBm	mW	dBm	W	dBm	W
-20	0.010	-6	0.250	+8	6.30	+22	159	+36	3.91	+50	100
-19	0.012	-5	0.316	+9	7.94	+23	200	+37	5.01	+51	126
-18	0.016	-4	0.398	+10	10.0	+24	251	+38	6.31	+52	158
-17	0.020	-3	0.501	+11	12.6	+25	316	+39	7.94	+53	200
-16	0.025	-2	0.630	+12	15.8	+26	398	+40	10.0	+54	251
-15	0.032	-1	0.794	+13	19.9	+27	501	+41	12.6	+55	316
-14	0.040	0	1.00	+14	25.1	+28	631	+42	15.8	+56	398
-13	0.050	+1	1.25	+15	31.6	+29	794	+43	20.0	+57	501
-12	0.063	+2	1.58	+16	39.8	+30	1000	+44	25.1	+58	631
-11	0.079	+3	2.00	+17	50.1	+31	1260	+45	31.6	+59	794
-10	0.100	+4	2.51	+18	63.1	+32	1590	+46	39.8	+60	1000
-9	0.130	+5	3.16	+19	79.4	+33	2000	+47	50.1	+63	2000
-8	0.160	+6	3.98	+20	100	+34	2550	+48	63.1	+66	4000
-7	0.200	+7	5.01	+21	120	+35	3160	+49	79.4	+70	10000

# Engineering information

## Intermodulation distortion in passive components

Intermodulation distortion in passive microwave components is caused by internal nonlinearities. In a truly linear system, the output is directly proportional to the input.

In a nonlinear system, the output signal is distorted by changes in the amplitude of the input signal. Intermodulation distortion creates new output signals from the nonlinear combinations of two or more input signals mixed together. A nonlinear circuit will create an infinite number of harmonics from two fundamental frequencies ( $f_1$  and  $f_2$ ). A particular concern for telecommunication systems engineers is the intermodulation product of the third order (such as  $2f_1 - f_2$  and  $2f_2 - f_1$ ), especially if  $f_1$  and  $f_2$  are closely spaced. With certain system designs and bandwidth allocations, the third order intermodulation products can be generated at the same frequencies as the receive channels of the system. In general, intermodulation products increase system noise and reduce the number of available channels.

Intermodulation distortion is most pronounced in systems where the high power transmission and low power receiver signals are carried simultaneously in the same transmission line, such as in the cable between the duplexer and the antenna in GSM base stations and in certain space applications. For low power levels, the effects of intermodulation distortion are significantly less. HUBER+SUHNER is involved in the research of the intermodulation problem as a participant in the IEC TC46 WG6 passive intermodulation working group.

Coaxial cable assemblies have often been viewed as linear components. However, pure linear components do not exist. There are small nonlinearities in the connectors and in the cable to connector junctions. Intermodulation distortion in connectors is usually caused by thin surface oxide layers at the connector junctions or by insufficient contact pressure when the current-carrying contact zones become separated. Separation is usually microscopic and can be caused by either electron tunneling or microscopic arcing. The presence of ferromagnetic materials in the current path may also contribute to intermodulation distortion.

Some simple design rules can help avoid intermodulation distortions in coaxial cable assemblies:

- Use of semi-rigid cable with a seamless outer conductor in place of flexible cable.
- Use of a solid center conductor in place of a stranded center conductor.
- Directly attach the outer conductor to the connector body by soldering or clamping in lieu of crimping.
- Limit the number of parts in the current path.
- Eliminate contaminants in the current path.
- Use high quality machining in the connector parts with a smooth surface finish.
- Avoid contaminants in the plating solutions.

- Ensure adequate and uniform plating thickness.
- Avoid use of magnetic materials in the current-carrying path.
- Ensure adequate contact pressure.
- Contact surface of female contact fingers should cover as close to 360 as possible (i. e. narrow slots or slotless).
- Use connector interfaces with radial dimensions as large as possible ( $7/16$  over N, N over SMA).

## Space applications

Every space application is unique and requires careful consideration before selecting the components to be used. A space environment subjects components and assemblies to severe environmental stress:

- Low earth orbit spacecraft subject solder joints, welds, brazements and mechanical connections to continuous hot/cold thermal cycling every 90 minutes. The manufacturing process must be carefully controlled per NASA STD-8739 requirements to assure consistent, reliable connections and assemblies. Solder connections must be 100 % X-rayed to assure their integrity and reliability.
- There is no atmosphere so convection cooling does not occur. Excess heat must be removed by radiation, which requires the surface of the connectors to be an infrared emitter, or by conduction which requires a secondary heat sink.
- Certain materials "outgas" in the extreme vacuum of space which requires the designer to select materials and components that meet NASA requirements for Total Mass Loss (TML) and Collected Volatile Condensable Material (CVCM) to avoid contamination of optics and other sensitive equipment on board the spacecraft.
- Materials must be carefully chosen so that ionising radiation does not destroy the connector or cable dielectric or the cable jacket.
- Multipaction failure (described in more detail herein) is a concern for high power applications.
- Intermodulation distortion (described in more detail herein) is a concern within systems where high power transmitting and low power receiving signals need to be carried simultaneously in the same transmission line.
- The manufacturing environment must be carefully controlled and the packaging materials selected to prevent dust and particles from accumulating on the components and subsequently contaminating the spacecraft.

Processes and controls used by HUBER+SUHNER for procurement, manufacture, assembly, soldering, X-ray, inspection and testing have been certified by NASA for use in spacecraft applications. HUBER+SUHNER has the design, manufacturing, testing and applications experience and expertise to supply your needs for passive microwave devices for use in any space environment.

# Engineering information

## Phase stability with flexure

Phase stability vs. flexure is a measure of the phase change of a cable as a result of flexing. The manner of flexure will affect insertion phase. Reducing the bend radius or increasing the bend angle will increase the phase change. Similarly, as the number of flexures increases the phase change will increase. Increasing the ratio of cable diameter to bend diameter will decrease the phase changes. Phase changes over frequency can be considered a linear response, although with some cables change can be more significant at higher frequencies. A microporous dielectric cable will typically have better phase stability than a solid dielectric.

## Phase stability vs. temperature

Phase stability vs. temperature is a measure of the signal speed variation when the cable is exposed to different temperatures. The values are specified in parts per million (ppm) or in degrees per gigahertz and meters (deg/(GHz\*m)). They usually refer to the difference between maximum and minimum values in a certain temperature range. They can be converted to each other using the following formula:

$$\Delta\varphi \text{ [deg/GHz/m]} * \frac{832.76 \text{ GHz*m/deg}}{\sqrt{\epsilon_r}} = \Delta\varphi \text{ [ppm]}$$
$$\Delta\varphi \text{ [ppm]} * \frac{\sqrt{\epsilon_r}}{832.76 \text{ GHz * m/deg}} = \Delta\varphi \text{ [deg/GHz/m]}$$

For frequencies in the low single-digit GHz range, the phase change is not proportional to the frequency anymore but for higher frequencies it is.

Main influences are the materials used and the construction of the cable. Most cables have different behaviors depending on the temperature range considered. There are sections with a linear or a non-linear behavior. Linear behavior show the influence of the regular length and volume expansion of the cable components. Non-linear sections originated from phase changes in materials or special mutual reactions between single elements of the cable. An example for a phase changes in materials is the devitrification of PTFE at 20 °C. At this temperature the crystal structure changes from triclinic to hexagonal. This leads to a rapid change of phase, the so called "Teflon® knee".

## Phase tracking

Phase tracking is the ability of multiple assemblies to closely reproduce their phase relative to each other over a range of temperature, flexure or both. Phase tracking is essentially a measure of the assemblies' mechanical repeatability and consistency. Thermal conditioning of coaxial cable enhances tracking characteristics.

## Phase matching

Phase matching is a term generally used to describe two or more cable assemblies with the same phase length. A more precise term is electrical length matching since phase measurements are from 0 ° to 360 ° of phase, with repeating cycles of 360 ° phase. The mechanical lengths of phase matched cable may not always be equal due to slight variations in the cable velocity of propagation. There are two distinctly different versions of phase matching: 1) absolute phase matched cables are matched to a predetermined phase value, and 2) relative phase matched cables are matched to each other. In either case, the tolerance of phase matching is frequency dependent although cable length and type may effect the matching capabilities.

# Engineering information

## Phase matching of cable assemblies

### Definition

The term "phase matching" refers to the relative electrical length of an assembly compared with a reference cable or a given electrical length.

### Absolute length

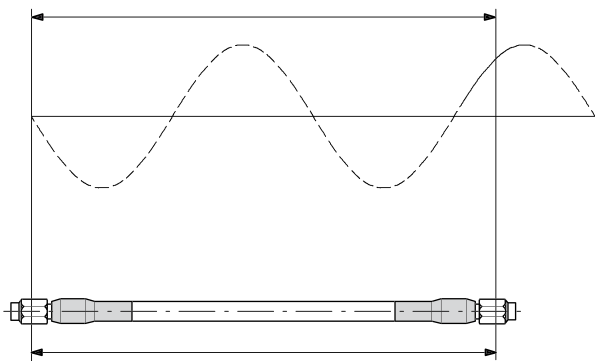

### Relative length

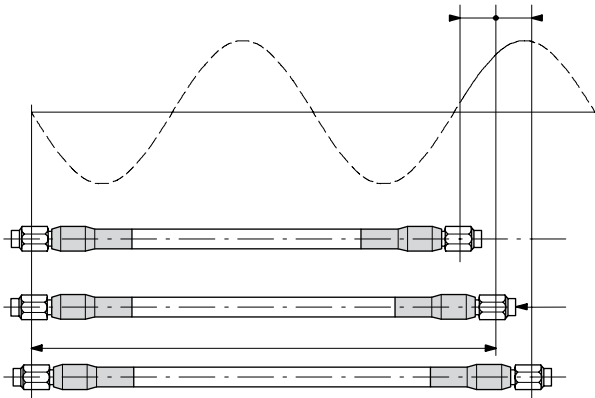

### Guarantee of phase matching

HUBER+SUHNER guarantees phase matching ex-factory. The relevant measurement logs are included in the supply. It is essential during installation and service to ensure that all assemblies of a phase matched set are exposed to the identical thermal and mechanical stresses.

### Reference cables

Usually, a reference cable is produced for each phase matched assembly set when an initial production run takes place. The absolute electrical length measured is internally saved. The reference cables are stored during 10 to 20 years under controlled conditions (temperature, humidity) together with the order data to allow individual assemblies to be replaced whenever the need arises.

### Attenuation (insertion loss)

Attenuation is a measure of the ability of a component to carry an RF signal efficiently. Coaxial cable loss is the sum of the dielectric and conductor losses and is a function of the materials used to manufacture the cable. Attenuation stability with flexure will have similar response characteristics as "phase vs. flexure" described previously, as will the "tracking" characteristics. Attenuation matching will not be as dependent upon the dielectric style, although for long lengths the insertion loss stability vs. flexure is critical.

$$A_i \left( \frac{dB}{100 ft} \right) = \frac{0.435 \sqrt{F}}{Z_0 \times d}$$

Inner conductor loss (where F is the frequency in MHz)

$$A_o \left( \frac{dB}{100 ft} \right) = \frac{0.435 \sqrt{F}}{Z_0 \times D}$$

Outer conductor loss

$$A_d \left( \frac{dB}{100 ft} \right) = 2.78 \rho \sqrt{\epsilon_r} \times F$$

Dielectric loss Where:  $\rho$  = power factor (loss tangent)  
 $\rho = 0.00016$  ( $\epsilon_r = 2.1$ )  
 $\rho = 0.00005$  ( $\epsilon_r = 1.6$ )

$$A = A_i + A_o + A_d$$

# Engineering information

## Abbreviations

Al	aluminium
AlCuAg	silver plated copper clad aluminium
CuAg	silver plated copper
CuSn	tin plated copper
ECTFE	ethylen-chlortrifluorethylen
ETFE	ethylene-tetrafluoroethylene
FEP	fluorinated ethylene propylene
LD-PTFE	low density PTFE
LSFH	low smoke free of halogen
MIL	hexagonal nut with safety holes
ML	mounting hole
PE	polyethylene
PTFE	polytetrafluorethen
PUR	polyurethane
QL	quick lock
Sn soaked Cu braid	tin soaked copper braid
SPE	foamed polyethylene
StCu	copper clad steel
StCuAg	silver plater copper clad steel
TP	tin plated
TP_M17	tin plated, MIL-C-17_QPL
ULD-PTFE	ultra low density PTFE





# Selection guide - quick assembly selection matrix

Cable type	Outer diameter (mm)	Frequency range (GHz)	VOP (%)	nom. cable attenuation (dB/m @ 18 GHz)	nom. cable attenuation (dB/m @ 26.5 GHz)	nom. cable attenuation (dB/m @ 40 GHz)	nom. cable attenuation (dB/m @ 50 GHz)	nom. cable attenuation (dB/m @ 67 GHz)	nom. cable attenuation (dB/m @ 110 GHz)	CW power @ 1 GHz sea level / 25 °C	CW Power @ 18 GHz sea level / 25 °C	Min. temperature (°C)	Max. temperature (°C)	Min. bending radius (static) (mm)	Weight (g/m)
SUCOFLEX 101	3.65	50	77	1.98	2.46	3.09	3.51			337	80	-55	125	11	36
SUCOFLEX 101 E	3.65	50	77	1.98	2.46	3.09	3.51			228	54	-40	85	11	33
SUCOFLEX 101 EA	7.7	50	77	1.98	2.46	3.09	3.51			205	48	-40	85	20	114
SUCOFLEX 101 P	3.65	50	77	2.95	3.72	4.78	5.50			313	74	-55	125	11	33
SUCOFLEX 101 PE	3.65	50	77	2.95	3.72	4.78	5.50			67	16	-40	85	11	30
SUCOFLEX 101 PEA	7.7	50	77	2.95	3.72	4.78	5.50			60	14	-40	85	20	111
SUCOFLEX 102	4.0	46	77	1.70	2.10	2.62				448	106	-55	125	12	40
SUCOFLEX 102E	4.0	46	77	1.70	2.10	2.62				273	64	-40	85	12	37
SUCOFLEX 102 EA	7.7	46	77	1.70	2.10	2.62				245	58	-40	85	20	120
SUCOFLEX 102 D	4.55	46	77	1.70	2.10	2.62				448	106	-55	125	15	45
SUCOFLEX 103	4.6	33	77	1.33	1.65					700	165	-55	125	13	53
SUCOFLEX 103 E	4.6	33	77	1.33	1.65					410	97	-40	85	13	52
SUCOFLEX 103 D	5.1	33	77	1.33	1.65					700	165	-55	125	20	63
SUCOFLEX 103 EA	10.3	33	77	1.33	1.65					369	87	-40	85	30	142
SUCOFLEX 104	5.5	26.5	77	1.10	1.37					1032	243	-55	125	16	73
SUCOFLEX 104 E	5.5	26.5	77	1.10	1.37					683	161	-40	85	16	65
SUCOFLEX 104 D	6.1	26.5	77	1.10	1.37					1032	243	-55	125	20	96
SUCOFLEX 126	5.5	26.5	77	1.10	1.37					1032	243	-55	125	16	70
SUCOFLEX 126 E	5.5	26.5	77	1.10	1.37					683	161	-40	85	16	66
SUCOFLEX 126 EA	10.3	26.5	77	1.10	1.37					614	144	-40	85	30	171
SUCOFLEX 106	7.9	18	77	0.76						1812	427	-55	125	24	145
SUCOFLEX 106 I	8.2	18	77	0.76						1058	249	-40	85	24	146
SUCOFLEX 106 D	8.3	18	77	0.76						1812	427	-55	125	26	157
SUCOFLEX 106A	13.2	18	77	0.76						1000	235	-40	85	50	224
SUCOFLEX 118	7.9	18	77	0.76						1812	427	-55	125	24	145
SUCOFLEX 118 A	13.2	18	77	0.76						1000	235	-40	85	50	224
SUCOFLEX 118 D	8.3	18	77	0.76						1812	427	-55	125	50	157
SUCOFLEX 118 I	8.2	18	77	0.76						1812	427	-40	85	50	146
SUCOFLEX 229	5.08	29	82	1.06	1.31					1206	284	-55	125	23	61
SUCOFLEX 229 A	10.3	29	82	1.06	1.31					500	118	-40	85	30	150
SUCOFLEX 240	4.14	40	82	1.60	1.98	2.47				682	161	-55	125	8.4	31
SUCOFLEX 301	3.5	18	77	1.97						131	31	-55	125	15	23.9
SUCOFLEX 301_Space	3.5	18	77	1.97						131	31	-55	150	15	23.9
SUCOFLEX 302	3.7	18	77	1.87						448	106	-55	125	15	29
SUCOFLEX 302 D	4.3	40	77	1.87	2.38	2.98				448	106	-55	125	15	31
SUCOFLEX 304	5.4	18	77	1.20						1032	243	-55	125	20	46
SUCOFLEX 304_Space	5.4	18	77	1.20						1032	243	-55	150	20	46

Cable type	Recommended for dynamic applications	Qualified acc. to MIL standards	High crush resistant, armoured	Excellent phase stability vs. bending	Excellent phase stability vs. temperature	Cable assembly only	Stock assemblies available	RF test lead	PIM test lead	Field terminable	High flexlife	Handformable	Form-stable	Halogen-free	Flame retardant, halogen-free	Low profile connectors (bent to the end)	More information see page
SUCOFLEX 101		•		•		•	•	•									16
SUCOFLEX 101 E				•		•		•									16
SUCOFLEX 101 EA	•		•	•		•	•	•									16
SUCOFLEX 101 P	•	•		•		•		•			•						16
SUCOFLEX 101 PE	•		•	•		•		•			•						16
SUCOFLEX 101 PEA	•		•	•		•		•			•						16
SUCOFLEX 102		•		•		•	•	•									20
SUCOFLEX 102E				•		•		•									20
SUCOFLEX 102 EA	•		•	•		•	•	•									20
SUCOFLEX 102 D		•	•	•		•											20
SUCOFLEX 103		•				•											24
SUCOFLEX 103 E						•											24
SUCOFLEX 103 D		•	•			•											24
SUCOFLEX 103 EA	•		•			•											24
SUCOFLEX 104		•				•	•	•									28
SUCOFLEX 104 E						•											28
SUCOFLEX 104 D		•	•			•		•									28
SUCOFLEX 126	•			•		•		•			•						34
SUCOFLEX 126 E	•			•		•	•	•			•						34
SUCOFLEX 126 EA	•		•	•		•	•	•			•						34
SUCOFLEX 106		•				•		•									38
SUCOFLEX 106 I						•											38
SUCOFLEX 106 D		•	•			•											38
SUCOFLEX 106A			•			•		•									38
SUCOFLEX 118	•	•		•		•		•			•						38
SUCOFLEX 118 A	•		•	•		•		•			•						38
SUCOFLEX 118 D	•	•	•	•		•					•						38
SUCOFLEX 118 I	•			•		•					•						38
SUCOFLEX 229	•	•		•	•	•	•	•									43
SUCOFLEX 229 A	•		•	•	•	•		•									43
SUCOFLEX 240	•	•		•	•	•		•									47
SUCOFLEX 301		•		•		•											51
SUCOFLEX 301_Space		•		•		•											51
SUCOFLEX 302		•		•		•											54
SUCOFLEX 302 D		•	•	•		•											54
SUCOFLEX 304		•				•											58
SUCOFLEX 304_Space		•				•											58

# Selection guide – quick assembly selection matrix

Cable type	Outer diameter (mm)	Frequency range (GHz)	VOP (%)	nom. cable attenuation (dB/m @ 18 GHz)	nom. cable attenuation (dB/m @ 26.5 GHz)	nom. cable attenuation (dB/m @ 40 GHz)	nom. cable attenuation (dB/m @ 50 GHz)	nom. cable attenuation (dB/m @ 67 GHz)	nom. cable attenuation (dB/m @ 110 GHz)	CW power @ 1 GHz sea level / 25 °C	CW Power @ 18 GHz sea level / 25 °C	Min. temperature (°C)	Max. temperature (°C)	Min. bending radius (static) (mm)	Weight (g/m)
SUCOFLEX 304 D	6.0	18	77	1.33						1032	243	-55	125	20	56
SUCOFLEX 307	9.0	8	77							1821	n/a	-55	150	50	133
SUCOFLEX 329	5.08	29	82	1.06	1.31					1206	284	-65	165	23	40
SUCOFLEX 340	4.14	40	82	1.60	1.98	2.47				682	161	-65	165	8.4	27
SUCOFLEX 404	5.5	26.5	89	0.99	1.23					967	228	-55	125	25	72
SUCOFLEX 404 D	6.1	26.5	89	0.99	1.23					967	228	-55	125	30	82
SUCOFLEX 404 A	10.3	26.5	89	0.99	1.23					725	171	-40	85	30	162
SUCOFLEX 406	8.3	18	89	0.64						1890	445	-55	125	30	145
SUCOFLEX 406 D	8.8	18	89	0.64						1890	445	-55	125	40	155
SUCOFLEX 406 A	13.2	18	89	0.64						1417	334	-40	85	50	203
SUCOFLEX 526V	13.0	26.5	80	2.68	3.38					150	35	15	30	50	275
SUCOFLEX 526S	7.7	26.5	77	1.1	1.36					1032	243	-55	125	25.4	70
MINIBEND	2.50	65	70.3	3.41	4.23	5.36	6.10			173	41	-55	125	5.08	14.9
MINIBEND L	2.64	50	76	2.70	3.30	4.10	4.61			288	68	-55	125	5.08	16.4
MICROBEND	1.96	90	70.3	4.67	5.76	7.23	8.2	9.67		111	26	-55	125	1.5	11.9
MINI 141	3.66	40	76.3	1.70	2.09	2.61				590	139	-55	125	8.4	31.3
SUCOTEST 26	4.8	26.5	76.3	1.70	2.09					716	169	-55	125	17.8	62.5
SUCOTEST 40	4.8	40	76.3	1.70	2.09	2.63				716	169	-55	125	17.8	62.5
SUCOTEST 18 A	10.3	18	77	1.56						512	121	-40	85	50	171
SUCOTEST 18	4.6	18	77	1.33						555	131	-55	105	100	53
TL-8A	10.3	8	82							560	n/a	-5	85	110	150
TL-P	10.3	4	69							560	n/a	-15	65	50	150
MULTIFLEX 53-02	1.74	67	71	5.19	6.46	8.17	9.30	11.05		34	8	-65	165	10	8.5
32055 (Boa-flex I)	5.46	26	77.3	1.09	1.35					1229	290	-55	200	22.9	64
32051 (Boa-flex I)	7.75	18	77.8	0.78						2260	533	-55	200	34.3	114.6
32021 (Steel-flex II)	3.66	45	76.5	1.90	2.37	2.99				510	120	-55	200	8.4	40.2
32022 (Steel-flex II)	3.65	40	76.3	1.70	2.09	2.61				590	139	-55	200	8.4	31.3
32024 (Steel-flex II)	2.69	40	76.5	2.70	3.33	4.10				288	68	-55	200	6.4	16.4
32026 (Steel-flex II)	4.82	40	76.3	1.71	2.09	2.63				716	173	-55	200	17.8	62.5
32094 (Steel-flex II)	5.46	26	77	1.15	1.43					1152	271	-55	200	22.8	61
32041 (Steel-flex I)	1.96	90	70.3	4.67	5.76	7.23	8.2	9.67		112	26	-55	200	1.5	11.9
32061 (Steel-flex I)	1.6	110	70.3	6.80	8.05	10.41	11.75	13.79	18.17	78	18	-55	200	5.08	7.4
32081 (Steel-flex I)	2.54	50	70.3	3.41	4.23	5.36	6.10			173	41	-55	200	5.1	14.9
32086 (Steel-flex I)	2.67	18	70.3	4.29						122	29	-55	200	5.1	14.9
32091 (Steel-flex I)	2.54	85	70	4.70	5.60	7.28	8.24	9.73		135	31	-55	200	5.1	16.4

Cable type	Recommended for dynamic applications	Qualified acc. to MIL standards	High crush resistant, armoured	Excellent phase stability vs. bending	Excellent phase stability vs. temperature	Cable assembly only	Stock assemblies available	RF test lead	PIM test lead	Field terminable	High flexlife	Handformable	Form-stable	Halogen-free	Flame retardant, halogen-free	Low profile connectors (bent to the end)	More information see page
SUCOFLEX 304 D		•	•			•											58
SUCOFLEX 307		•				•											61
SUCOFLEX 329		•		•	•	•											64
SUCOFLEX 340		•		•	•	•											67
SUCOFLEX 404		•			•	•											71
SUCOFLEX 404 D		•	•		•	•											71
SUCOFLEX 404 A			•		•	•											71
SUCOFLEX 406		•			•	•											74
SUCOFLEX 406 D		•	•		•	•											74
SUCOFLEX 406 A			•		•	•											74
SUCOFLEX 526V	•		•	•	•	•	•	•			•						80
SUCOFLEX 526S	•		•	•		•	•	•			•						83
MINIBEND		•				•	•									•	88
MINIBEND L		•				•	•									•	98
MICROBEND		•				•	•									•	100
MINI 141		•				•	•									•	109
SUCOTEST 26						•	•	•									116
SUCOTEST 40						•	•	•									116
SUCOTEST 18 A	•		•	•		•	•	•									119
SUCOTEST 18						•	•	•									122
TL-8A	•		•			•	•	•									124
TL-P	•		•			•	•	•	•								126
MULTIFLEX 53-02	•			•							•						153
32055 (Boa-flex I)																	132
32051 (Boa-flex I)																	132
32021 (Steel-flex II)		•				•	•									•	137
32022 (Steel-flex II)		•						•								•	136
32024 (Steel-flex II)																•	136
32026 (Steel-flex II)							•	•									137
32094 (Steel-flex II)	•			•				•			•						137
32041 (Steel-flex I)		•														•	140
32061 (Steel-flex I)																	140
32081 (Steel-flex I)		•														•	140
32086 (Steel-flex I)	•										•						140
32091 (Steel-flex I)		•														•	141

# Selection guide – quick assembly selection matrix

Cable type	Outer diameter (mm)	Frequency range (GHz)	VOP (%)	nom. cable attenuation (dB/m @ 18 GHz)	nom. cable attenuation (dB/m @ 26.5 GHz)	nom. cable attenuation (dB/m @ 40 GHz)	nom. cable attenuation (dB/m @ 50 GHz)	nom. cable attenuation (dB/m @ 67 GHz)	nom. cable attenuation (dB/m @ 110 GHz)	CW power @ 1 GHz sea level / 25 °C	CW Power @ 18 GHz sea level / 25 °C	Min. temperature (°C)	Max. temperature (°C)	Min. bending radius (static) (mm)	Weight (g/m)
MULTIFLEX 86	2.65	40	71	3.55	4.46	5.66				159	37	-65	165	6	21
MULTIFLEX 86_HE	2.65	67	71	3.56	4.57	5.69	6.52	7.81		169	40	-65	165	10	21
MULTIFLEX 141	4.14	33	71	2.09	2.67					424	100	-65	165	10	45
S 04272 B	5.5	18	82	1.64						137	32	-40	85	25	44
S 04262 B-01	5.5	18	82	1.64						137	32	-40	85	25	41
S 04212 B	5.5	18	82	1.64						137	32	-40	85	25	41
32084 (everflex)	2.38	40	76	3.59	4.17	5.43				191	45	-55	200	5.1	10.4
32071 (boa_Flex II)	9.5	14	77.8							3413	n/a	-55	200	50.8	208.3
EACON 2C	3.75	18	77	1.70						448	106	-55	200	12	39
EACON 4C	5.5	18	77	1.10						1032	243	-55	200	16	73
EACON 6C	7.7	18	77	0.76						1812	427	-55	200	24	148
SUCOFORM 47 CU	1.2	40	71	5.44	6.79	8.62				36	9	-65	165	3.18	6
SUCOFORM 86	2.1	40	71	3.39	4.30	5.57				184	43	-65	165	6	15
SUCOFORM 141	3.58	33	71	2.23	2.89					484	114	-65	165	8	38
SUCOFORM 250-01	6.35	18	71	1.45						1047	247	-65	165	30	130
SUCOFORM 47 CU-LSFH	1.7	40	71	5.44	6.79	8.62				13	3	-40	85	4	7
SUCOFORM 86 PE	3.2	40	71	3.39	4.30	5.57				34	8	-40	85	6	19
SUCOFORM 86 FEP	2.5	40	71	3.39	4.30	5.57				319	75	-65	165	6	18
SUCOFORM 141 CU-PE	4.6	33	71	2.23	2.89					102	24	-40	85	8	47
SUCOFORM 141 CU-FEP	4.1	33	71	2.23	2.89					637	150	-65	165	8	47
SUCOFORM 250-01 FEP	6.8	18	71	1.45						1138	268	-65	165	30	138
31000 (cobra-flex)	3.58	32	70.3	1.81	2.38					491	116	-55	200	19.1	35.7
31000S (cobra-flex)	3.58	32	70.3	1.81	2.38					491	116	-55	200	19.1	35.7
31086 (cobra-flex)	2.18	40	70.3	3.45	4.22	5.42				167	39	-55	200	8.9	20.8
EZ 47 TP/M17	1.19	67	69.5	5.13	6.41	8.17	9.34	11.18		36	9	-40	100	3.18	7.1
EZ 86 TP/M17	2.2	67	69.5	3.19	4.07	5.28	6.12	7.44		148	35	-40	125	3.18	24
EZ 118 TP	2.95	40	80	1.76	2.17	2.72				680	160	-40	125	9.53	34
EZ 141 TP/M17	3.58	33	69.5	2.09	2.73					512	121	-40	125	6.35	52
EZ 250 TP/M17	6.35	18	69.5	1.50						1593	376	-40	90	19	158
EZ 47 AL TP/M17	1.19	67	69.5	5.40	6.74	8.57	9.79	11.69		36	9	-40	100	1.27	3.1
EZ 86 AL TP/M17	2.2	67	69.5	3.34	4.25	5.51	6.37	7.73		148	35	-40	125	1.78	11.9
EZ 141 AL TP/M17	3.58	33	69.5	2.18	2.83					512	121	-40	125	3.18	30.5
EZ 250 AL TP/M17	6.35	18	69.5	1.55						1593	376	-40	90	19	88.6

Cable type	Recommended for dynamic applications	Qualified acc. to MIL standards	High crush resistant, armoured	Excellent phase stability vs. bending	Excellent phase stability vs. temperature	Cable assembly only	Stock assemblies available	RF test lead	PIM test lead	Field terminable	High flexlife	Handformable	Form-stable	Halogen-free	Flame retardant, halogen-free	Low profile connectors (bent to the end)	More information see page
MULTIFLEX 86																	144
MULTIFLEX 86_HE	•			•													144
MULTIFLEX 141																	144
S 04272 B														•			148
S 04262 B-01														•	•		148
S 04212 B														•			148
32084 (everflex)	•					•					•						151
32071 (boa_Flex II)																	157
EACON 2C										•							159
EACON 4C										•							159
EACON 6C										•							159
SUCOFORM 47 CU												•					166
SUCOFORM 86												•					166
SUCOFORM 141												•					166
SUCOFORM 250-01												•					166
SUCOFORM 47 CU-LSFH												•					168
SUCOFORM 86 PE												•					168
SUCOFORM 86 FEP												•					168
SUCOFORM 141 CU-PE												•					168
SUCOFORM 141 CU-FEP												•					168
SUCOFORM 250-01 FEP												•					168
31000 (cobra-flex)													•				172
31000S (cobra-flex)													•				172
31086 (cobra-flex)													•				172
EZ 47 TP/M17		•											•				175
EZ 86 TP/M17		•											•				175
EZ 118 TP													•				175
EZ 141 TP/M17		•											•				175
EZ 250 TP/M17		•											•				175
EZ 47 AL TP/M17		•											•				176
EZ 86 AL TP/M17		•											•				176
EZ 141 AL TP/M17		•											•				176
EZ 250 AL TP/M17		•											•				176











HUBER+SUHNER AG  
Radio Frequency Division  
Degersheimerstrasse 14  
9100 Herisau  
Switzerland  
Phone +41 71 353 4111  
Fax +41 71 353 4444  
hubersuhner.com

HUBER+SUHNER is certified according to EN(AS) 9100, ISO 9001, ISO 14001, ISO/TS 16949 and IRIS.

**Waiver**

Fact and figures herein are for information only and do not represent any warranty of any kind.



Компания «Life Electronics» занимается поставками электронных компонентов импортного и отечественного производства от производителей и со складов крупных дистрибьюторов Европы, Америки и Азии.

С конца 2013 года компания активно расширяет линейку поставок компонентов по направлению коаксиальный кабель, кварцевые генераторы и конденсаторы (керамические, пленочные, электролитические), за счёт заключения дистрибьюторских договоров

Мы предлагаем:

- Конкурентоспособные цены и скидки постоянным клиентам.
- Специальные условия для постоянных клиентов.
- Подбор аналогов.
- Поставку компонентов в любых объемах, удовлетворяющих вашим потребностям.
- Приемлемые сроки поставки, возможна ускоренная поставка.
- Доставку товара в любую точку России и стран СНГ.
- Комплексную поставку.
- Работу по проектам и поставку образцов.
- Формирование склада под заказчика.
- Сертификаты соответствия на поставляемую продукцию (по желанию клиента).
- Тестирование поставляемой продукции.
- Поставку компонентов, требующих военную и космическую приемку.
- Входной контроль качества.
- Наличие сертификата ISO.

В составе нашей компании организован Конструкторский отдел, призванный помогать разработчикам, и инженерам.

Конструкторский отдел помогает осуществить:

- Регистрацию проекта у производителя компонентов.
- Техническую поддержку проекта.
- Защиту от снятия компонента с производства.
- Оценку стоимости проекта по компонентам.
- Изготовление тестовой платы монтаж и пусконаладочные работы.



Тел: +7 (812) 336 43 04 (многоканальный)

Email: [org@lifeelectronics.ru](mailto:org@lifeelectronics.ru)