

Cree® XLamp® XP-E2 LEDs

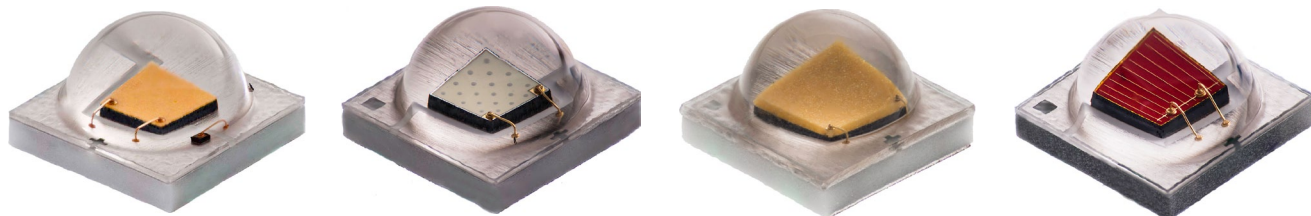

PRODUCT DESCRIPTION

The XLamp® XP-E2 LED builds on the unprecedented performance of the original XP-E by increasing lumen output up to 20% while providing a single die LED point source for precise optical control. The XP-E2 LED shares the same footprint as the original XP-E, providing a seamless upgrade path to more lumens and/or greater efficiency while shortening the design cycle for existing XP customers.

XLamp XP-E2 LEDs are the ideal choice for lighting applications where high light output and maximum efficacy are required, such as LED retrofit lamps, outdoor, portable, indoor directional, emergency vehicle or architectural.

FEATURES

- Available in white, outdoor white, 80-CRI, 85-CRI, 90-CRI white, royal blue, blue, green, PC amber, amber, red-orange & red
- ANSI-compatible chromaticity bins
- White binned at 85 °C
- Maximum drive current: 1 A
- Low thermal resistance: as low as 5 °C/W
- Wide viewing angle: 110°-135°
- Unlimited floor life at ≤ 30 °C/85% RH
- Reflow solderable - JEDEC J-STD-020C compatible
- Electrically neutral thermal path
- RoHS- and REACH-compliant
- UL® recognized component (E349212)

TABLE OF CONTENTS

| | |
|---|----|
| Characteristics | 2 |
| Flux Characteristics - White..... | 3 |
| Flux Characteristics - Color | 4 |
| Relative Spectral Power Distribution | 6 |
| Relative Flux vs. Junction Temperature..... | 7 |
| Electrical Characteristics - White | 8 |
| Electrical Characteristics - Color..... | 8 |
| Relative Flux vs. Current - White..... | 9 |
| Relative Flux vs. Current - Color | 9 |
| Relative Chromaticity vs. Current and Temperature | 10 |
| Typical Spatial Distribution..... | 11 |
| Thermal Design | 12 |
| Reflow Soldering Characteristics..... | 13 |
| Notes | 14 |
| Mechanical Dimensions | 16 |
| Tape and Reel..... | 17 |
| Packaging..... | 18 |



CHARACTERISTICS

| Characteristics | Unit | Minimum | Typical | Maximum |
|--|---------|---------|---------|---------|
| Thermal resistance, junction to solder point - white, royal blue, blue | °C/W | | 9 | |
| Thermal resistance, junction to solder point - green | °C/W | | 15 | |
| Thermal resistance, junction to solder point - PC amber | °C/W | | 9 | |
| Thermal resistance, junction to solder point - amber | °C/W | | 7 | |
| Thermal resistance, junction to solder point - red-orange, red | °C/W | | 5 | |
| Viewing angle (FWHM) - white | degrees | | 110 | |
| Viewing angle (FWHM) - royal blue, blue, green | degrees | | 135 | |
| Viewing angle (FWHM) - PC amber | degrees | | 110 | |
| Viewing angle (FWHM) - amber, red-orange, red | degrees | | 130 | |
| Temperature coefficient of voltage - white | mV/°C | | -2.3 | |
| Temperature coefficient of voltage - royal blue, blue | mV/°C | | -3.3 | |
| Temperature coefficient of voltage - green | mV/°C | | -3.8 | |
| Temperature coefficient of voltage - PC amber | mV/°C | | -2.5 | |
| Temperature coefficient of voltage - amber, red-orange, red | mV/°C | | -1.8 | |
| ESD withstand voltage (HBM per Mil-Std-883D)- white, royal blue, blue, green | V | | | 8000 |
| ESD classification (HBM per Mil-Std-883D) - PC amber, amber, red-orange, red | | | Class 2 | |
| DC forward current | mA | | | 1000 |
| Reverse voltage | V | | | 5 |
| Forward voltage (@ 350 mA, 85 °C) - white | V | | 2.9 | 3.25 |
| Forward voltage (@ 700 mA, 85 °C) - white | | | 3.05 | |
| Forward voltage (@ 1000 mA, 85 °C) - white | | | 3.15 | |
| Forward voltage (@ 350 mA, 25 °C) - royal blue, blue | V | | 3.1 | 3.5 |
| Forward voltage (@ 1000 mA, 25 °C) - royal blue, blue | V | | 3.4 | |
| Forward voltage (@ 350 mA, 25 °C) - green | V | | 3.2 | 3.8 |
| Forward voltage (@ 1000 mA, 25 °C) - green | V | | 3.7 | |
| Forward voltage (@ 350 mA, 25 °C) - PC amber | V | | 3.05 | 3.5 |
| Forward voltage (@ 1000 mA, 25 °C) - PC amber | V | | 3.28 | |
| Forward voltage (@ 350 mA, 25 °C) - amber, red-orange, red | V | | 2.2 | 2.6 |
| Forward voltage (@ 1000 mA, 25 °C) - amber, red-orange, red | V | | 2.65 | |
| LED junction temperature | °C | | | 150 |

FLUX CHARACTERISTICS (T_J = 85 °C) - WHITE

The following table provides several base order codes for XLamp XP-E2 LEDs. It is important to note that the base order codes listed here are a subset of the total available order codes for the product family. For more order codes, as well as a complete description of the order-code nomenclature, please consult the XLamp XP Family LEDs Binning and Labeling document.

| Color | CCT Range | | Minimum Luminous Flux (lm) @ 350 mA | | | Calculated Minimum Luminous Flux (lm)** @ 85 °C | | Order Code |
|---------------|-----------|----------|--|----------------------|-----------------------|---|-------|----------------------|
| | Min. | Max. | Group | Flux (lm) @ 85 °C | Flux (lm) @ 25 °C* | 700 mA | 1.0 A | |
| Cool White | 5000 K | 10,000 K | Q4 | 100 | 116 | 171 | 218 | XPEBWT-L1-0000-00C51 |
| | | | Q5 | 107 | 124 | 183 | 233 | XPEBWT-L1-0000-00D51 |
| | | | R2 | 114 | 132 | 195 | 249 | XPEBWT-L1-0000-00E51 |
| | | | R3 | 122 | 142 | 209 | 266 | XPEBWT-L1-0000-00F51 |
| | | | R4 | 130 | 152 | 223 | 284 | XPEBWT-L1-0000-00G51 |
| Outdoor White | 4000 K | 5300 K | Q4 | 100 | 116 | 171 | 218 | XPEBWT-01-0000-00CC2 |
| | | | Q5 | 107 | 124 | 183 | 233 | XPEBWT-01-0000-00DC2 |
| | | | R2 | 114 | 132 | 195 | 249 | XPEBWT-01-0000-00EC2 |
| | | | R3 | 122 | 142 | 209 | 266 | XPEBWT-01-0000-00FC2 |
| Neutral White | 3700 K | 5300 K | Q4 | 100 | 116 | 171 | 218 | XPEBWT-L1-0000-00CE4 |
| | | | Q5 | 107 | 124 | 183 | 233 | XPEBWT-L1-0000-00DE4 |
| | | | R2 | 114 | 132 | 195 | 249 | XPEBWT-L1-0000-00EE4 |
| 80-CRI White | 2200 K | 4300 K | Q2 | 87.4 | 101 | 150 | 191 | XPEBWT-H1-0000-00AE7 |
| | | | Q3 | 93.9 | 109 | 161 | 205 | XPEBWT-H1-0000-00BE7 |
| Warm White | 2200 K | 3700 K | Q2 | 87.4 | 101 | 150 | 191 | XPEBWT-L1-0000-00AE7 |
| | | | Q3 | 93.9 | 109 | 161 | 205 | XPEBWT-L1-0000-00BE7 |
| | | | Q4 | 100 | 116 | 171 | 218 | XPEBWT-L1-0000-00CE7 |
| 85-CRI White | 2600 K | 3200 K | P2 | 67.2 | 78.0 | 115 | 147 | XPEBWT-P1-0000-007E7 |
| | | | P3 | 73.9 | 85.7 | 127 | 161 | XPEBWT-P1-0000-008E7 |
| | | | P4 | 80.6 | 93.5 | 138 | 176 | XPEBWT-P1-0000-009E7 |
| | | | Q2 | 87.4 | 101 | 150 | 191 | XPEBWT-P1-0000-00AE7 |
| 90-CRI White | 2600 K | 3200 K | P2 | 67.2 | 78.0 | 115 | 147 | XPEBWT-U1-0000-007E7 |
| | | | P3 | 73.9 | 85.7 | 127 | 161 | XPEBWT-U1-0000-008E7 |
| | | | P4 | 80.6 | 93.5 | 138 | 176 | XPEBWT-U1-0000-009E7 |

Notes:

- Cree maintains a tolerance of ±7% on flux and power measurements, ±0.005 on chromaticity (CCx, CCy) measurements and ±2 on CRI measurements. See the Measurements section (page 14).
- Typical CRI for Cool White (5000 K – 10,000 K CCT) is 70.
- Typical CRI for Neutral White (3700 K – 5300 K CCT) is 75.
- Typical CRI for Outdoor White (4000 K - 5300 K CCT) is 70.
- Typical CRI for Warm White (2200 K – 3700 K CCT) is 80.
- Minimum CRI for 80-CRI White is 80.
- Minimum CRI for 85-CRI White is 85.
- Minimum CRI for 90-CRI White is 90.
- * Flux values @ 25 °C are calculated and for reference only.
- ** Calculated flux values at 700 mA and 1 A are for reference only.

FLUX CHARACTERISTICS ($T_j = 25\text{ }^\circ\text{C}$) - COLOR

The following tables provide several base order codes for XLamp XP-E2 color LEDs. It is important to note that the base order codes listed here are a subset of the total available order codes for the product family. For more order codes, as well as a complete description of the order-code nomenclature, please consult the XLamp XP Family LEDs Binning and Labeling document.

| Color | Minimum Radiant Flux @ 350 mA | | Dominant Wavelength Range | | | | Order Codes, |
|------------|-------------------------------|-----------|---------------------------|----------|-------|----------|----------------------|
| | Group | Flux (mW) | Min. | | Max. | | |
| | | | Group | DWL (nm) | Group | DWL (nm) | |
| Royal Blue | 30 | 450 | D3 | 450 | D5 | 465 | XPEBRY-L1-0000-00J01 |
| | 31 | 475 | D3 | 450 | D5 | 465 | XPEBRY-L1-0000-00K01 |
| | 32 | 500 | D3 | 450 | D5 | 465 | XPEBRY-L1-0000-00L01 |
| | 33 | 525 | D3 | 450 | D5 | 465 | XPEBRY-L1-0000-00M01 |
| | 34 | 550 | D3 | 450 | D5 | 465 | XPEBRY-L1-0000-00N01 |
| | 35 | 575 | D3 | 450 | D5 | 465 | XPEBRY-L1-0000-00P01 |
| | 36 | 600 | D3 | 450 | D5 | 465 | XPEBRY-L1-0000-00Q01 |
| | 37 | 625 | D3 | 450 | D5 | 465 | XPEBRY-L1-0000-00R01 |

| Color | Dominant Wavelength Range | | | | Minimum Luminous Flux (lm) @ 350 mA | | Order Code |
|-------|---------------------------|----------|-------|----------|-------------------------------------|-----------|----------------------|
| | Min. | | Max. | | Group | Flux (lm) | |
| | Group | DWL (nm) | Group | DWL (nm) | | | |
| Blue | B3 | 465 | B6 | 485 | K2 | 30.6 | XPEBBL-L1-0000-00Y01 |
| | | | | | K3 | 35.2 | XPEBBL-L1-0000-00Z01 |
| | | | | | M2 | 39.8 | XPEBBL-L1-0000-00201 |
| | | | | | M3 | 45.7 | XPEBBL-L1-0000-00301 |

| Color | Dominant Wavelength Range | | | | Minimum Luminous Flux (lm) @ 350 mA | | Order Code |
|-------|---------------------------|----------|-------|----------|-------------------------------------|-----------|----------------------|
| | Min. | | Max. | | Group | Flux (lm) | |
| | Group | DWL (nm) | Group | DWL (nm) | | | |
| Green | G2 | 520 | G4 | 535 | Q2 | 87.4 | XPEBGR-L1-0000-00A01 |
| | | | | | Q3 | 93.9 | XPEBGR-L1-0000-00B01 |
| | | | | | Q4 | 100 | XPEBGR-L1-0000-00C01 |
| | | | | | Q5 | 107 | XPEBGR-L1-0000-00D01 |
| | | | | | R2 | 114 | XPEBGR-L1-0000-00E01 |
| | | | | | R3 | 122 | XPEBGR-L1-0000-00F01 |
| | | | | | R4 | 130 | XPEBGR-L1-0000-00G01 |

- Note:
- Cree maintains a tolerance of $\pm 7\%$ on flux and power measurements, ± 0.005 on chromaticity (CCx, CCy) measurements and ± 2 on CRI measurements.

FLUX CHARACTERISTICS (T_j = 25 °C) - COLOR (CONTINUED)

| Color | Color Bin | Minimum Luminous Flux (lm) @ 350 mA | | Order Code |
|----------|-----------|-------------------------------------|-----------|----------------------|
| | | Group | Flux (lm) | |
| PC Amber | Y2 | Q2 | 87.4 | XPEBPA-L1-0000-00A01 |
| | | Q3 | 93.9 | XPEBPA-L1-0000-00B01 |
| | | Q4 | 100 | XPEBPA-L1-0000-00C01 |
| | | Q5 | 107 | XPEBPA-L1-0000-00D01 |

| Color | Dominant Wavelength Range | | | | Minimum Luminous Flux (lm) @ 350 mA | | Order Code |
|-------|---------------------------|----------|-------|----------|-------------------------------------|-----------|----------------------|
| | Min. | | Max. | | Group | Flux (lm) | |
| | Group | DWL (nm) | Group | DWL (nm) | | | |
| Amber | A2 | 585 | A3 | 595 | N4 | 62.0 | XPEBAM-L1-0000-00601 |
| | | | | | P2 | 67.2 | XPEBAM-L1-0000-00701 |
| | | | | | P3 | 73.9 | XPEBAM-L1-0000-00801 |
| | | | | | P4 | 80.6 | XPEBAM-L1-0000-00901 |

| Color | Dominant Wavelength Range | | | | Minimum Luminous Flux (lm) @ 350 mA | | Order Code |
|------------|---------------------------|----------|-------|----------|-------------------------------------|-----------|----------------------|
| | Min. | | Max. | | Group | Flux (lm) | |
| | Group | DWL (nm) | Group | DWL (nm) | | | |
| Red-Orange | O3 | 610 | O4 | 620 | P2 | 67.2 | XPEBRO-L1-0000-00701 |
| | | | | | P3 | 73.9 | XPEBRO-L1-0000-00801 |
| | | | | | P4 | 80.6 | XPEBRO-L1-0000-00901 |
| | | | | | Q2 | 87.4 | XPEBRO-L1-0000-00A01 |
| | | | | | Q3 | 93.9 | XPEBRO-L1-0000-00B01 |
| | | | | | Q4 | 100 | XPEBRO-L1-0000-00C01 |
| | | | | | Q5 | 107 | XPEBRO-L1-0000-00D01 |

| Color | Dominant Wavelength Range | | | | Minimum Luminous Flux (lm) @ 350 mA | | Order Code |
|-------|---------------------------|----------|-------|----------|-------------------------------------|-----------|----------------------|
| | Min. | | Max. | | Group | Flux (lm) | |
| | Group | DWL (nm) | Group | DWL (nm) | | | |
| Red | R2 | 620 | R3 | 630 | N3 | 56.8 | XPEBRD-L1-0000-00501 |
| | | | | | N4 | 62.0 | XPEBRD-L1-0000-00601 |
| | | | | | P2 | 67.2 | XPEBRD-L1-0000-00701 |
| | | | | | P3 | 73.9 | XPEBRD-L1-0000-00801 |
| | | | | | P4 | 80.6 | XPEBRD-L1-0000-00901 |

Note:
 • Cree maintains a tolerance of ±7% on flux and power measurements, ±0.005 on chromaticity (CCx, CCy) measurements and ±2 on CRI measurements.

RELATIVE SPECTRAL POWER DISTRIBUTION

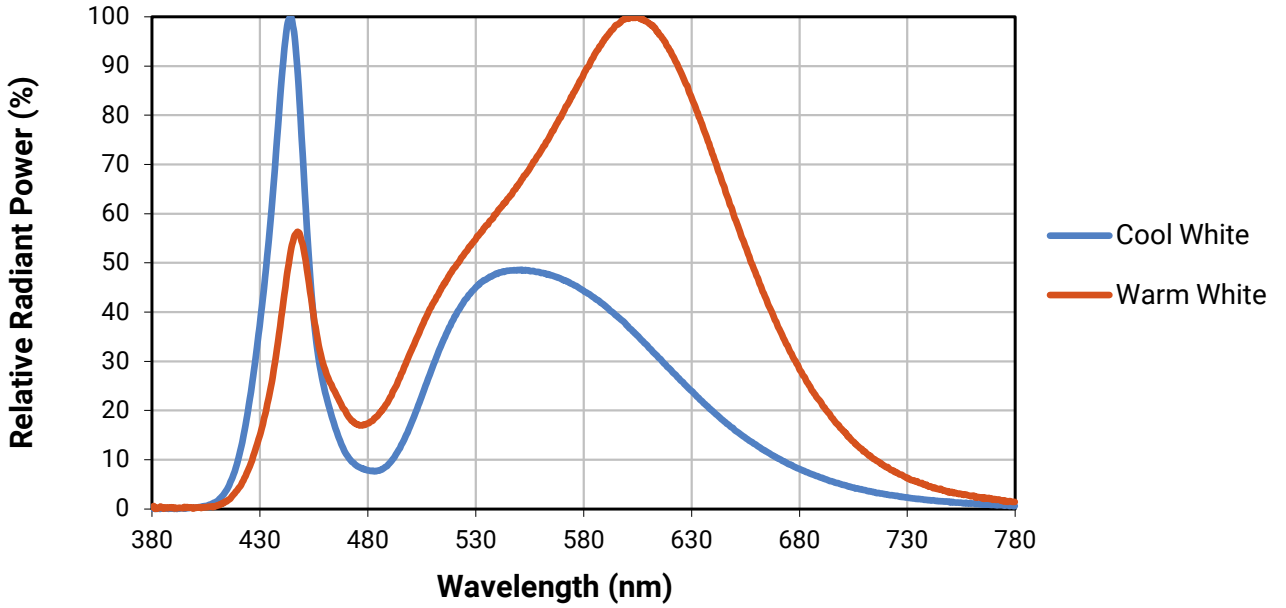

RELATIVE FLUX VS. JUNCTION TEMPERATURE ($I_F = 350$ mA)

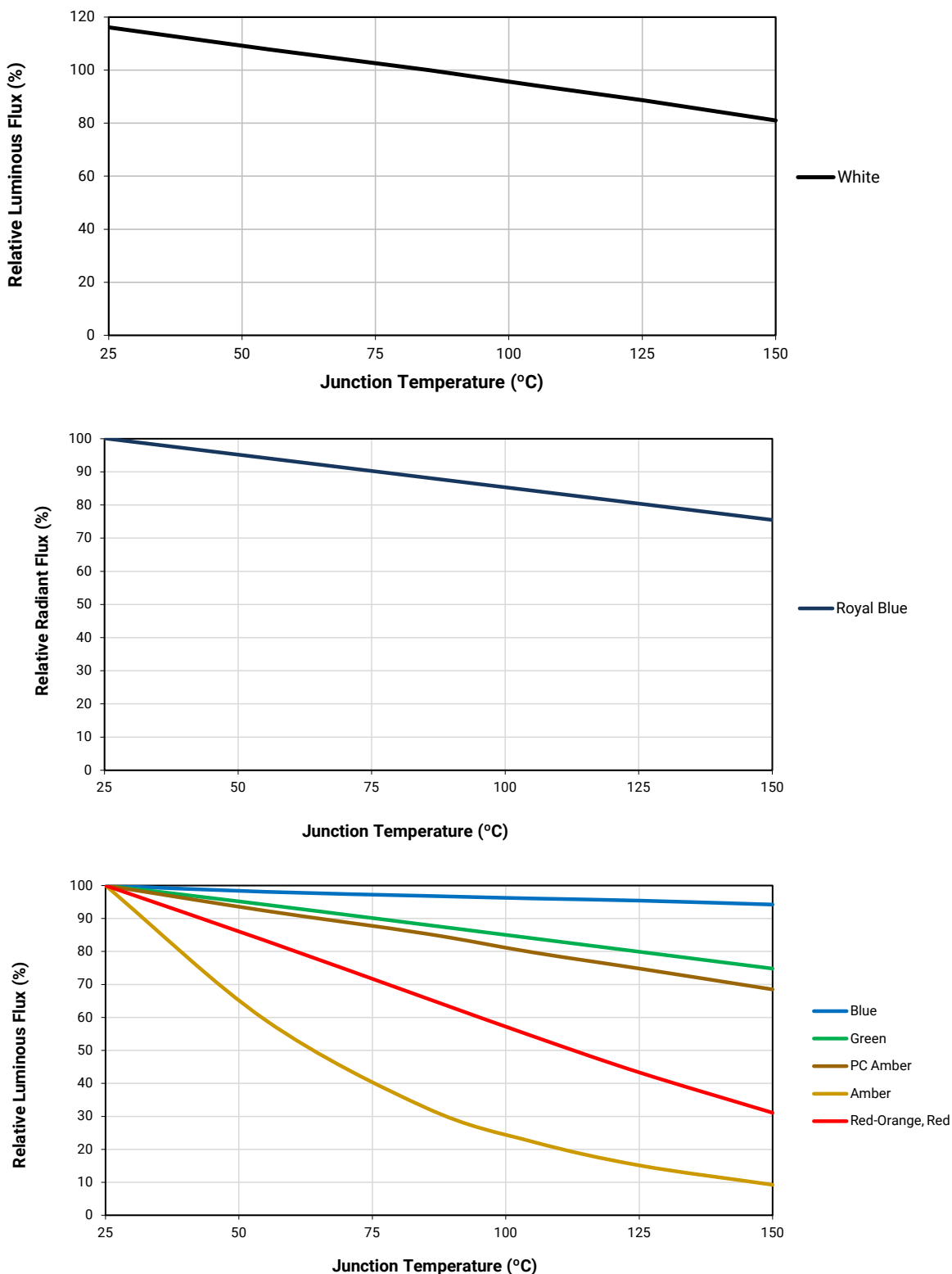

ELECTRICAL CHARACTERISTICS ($T_j = 85\text{ }^\circ\text{C}$) - WHITE



ELECTRICAL CHARACTERISTICS ($T_j = 25\text{ }^\circ\text{C}$) - COLOR

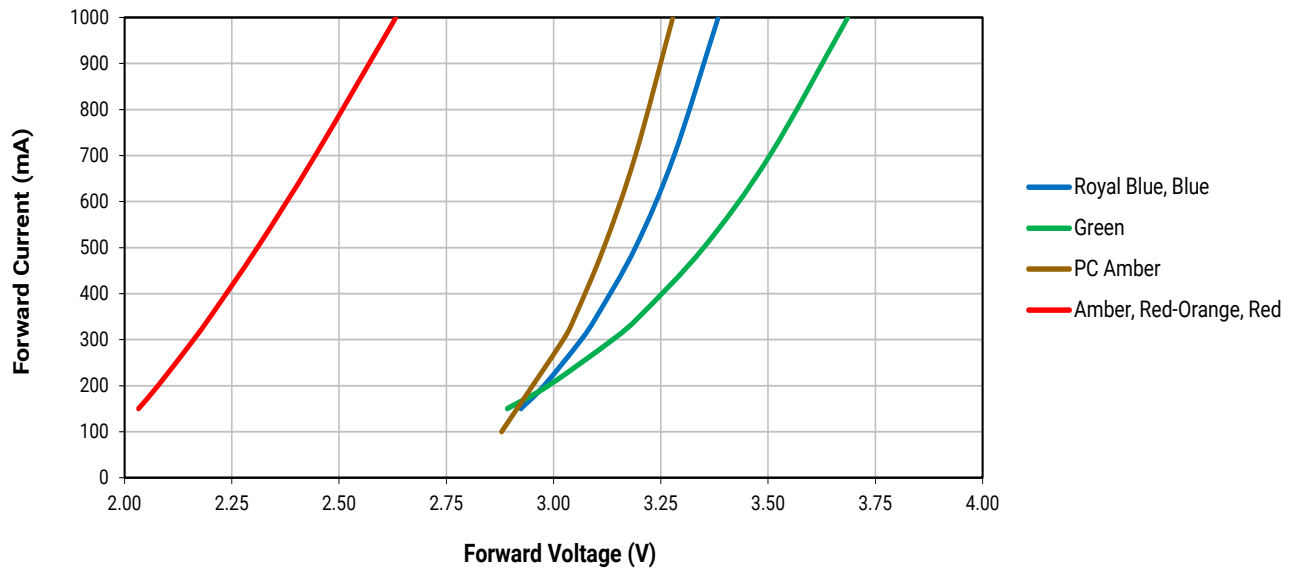

RELATIVE FLUX VS. CURRENT ($T_j = 85\text{ }^\circ\text{C}$) - WHITE



RELATIVE FLUX VS. CURRENT ($T_j = 25\text{ }^\circ\text{C}$) - COLOR

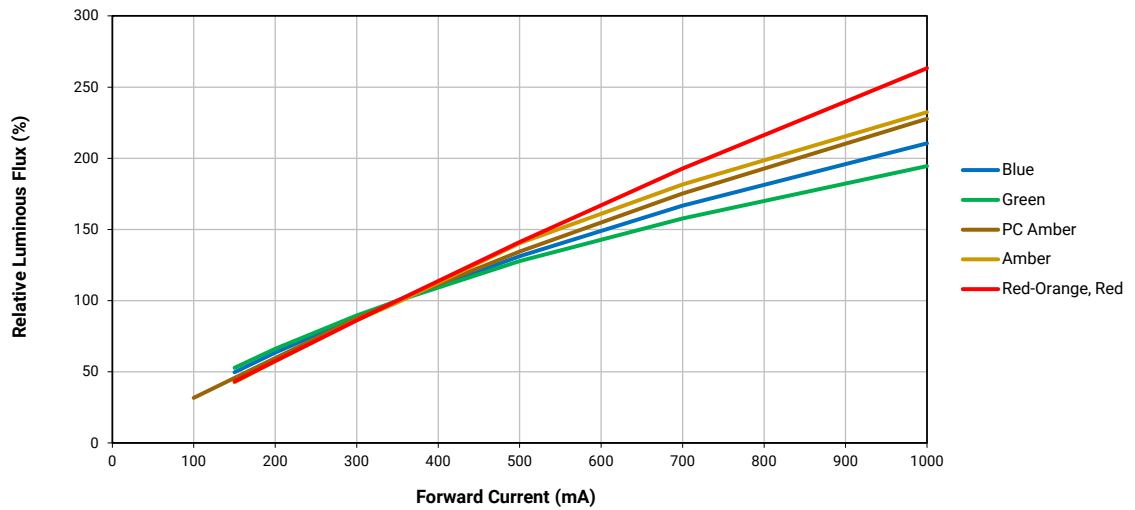
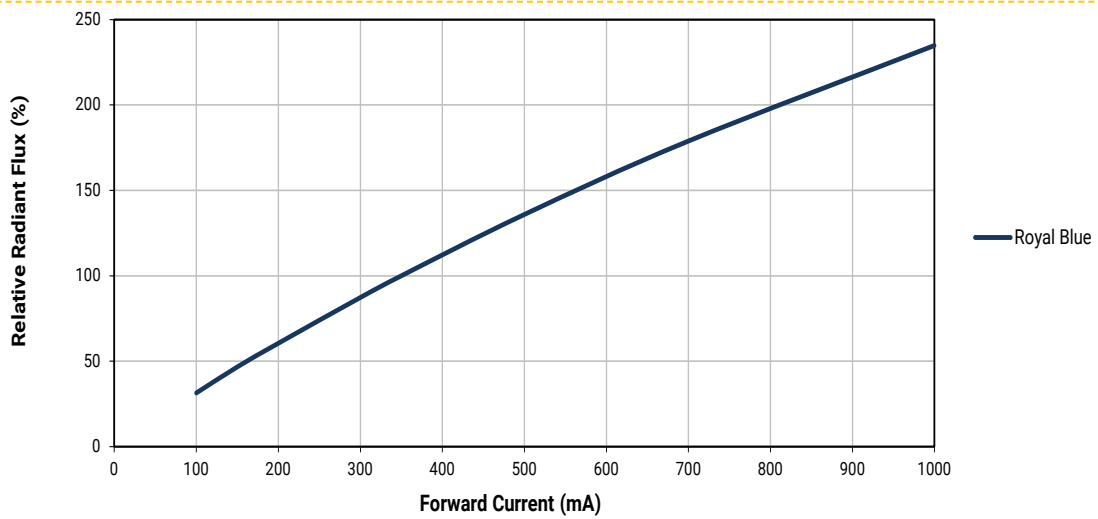

RELATIVE CHROMATICITY VS. CURRENT AND TEMPERATURE - WARM WHITE*



* Warm White XLamp XP-E2 LEDs have a typical CRI of 80.

TYPICAL SPATIAL DISTRIBUTION

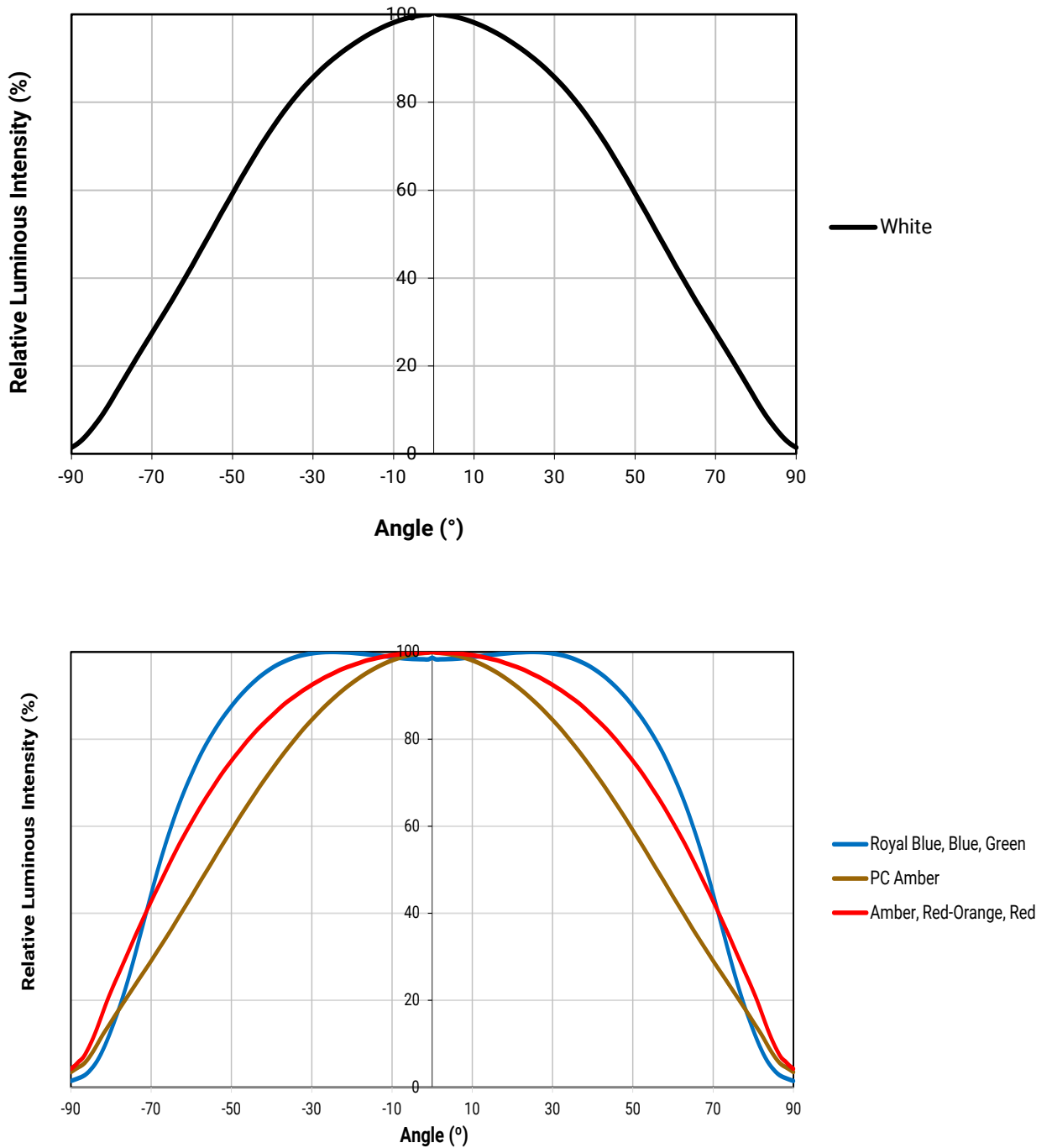

THERMAL DESIGN

The maximum forward current is determined by the thermal resistance between the LED junction and ambient. It is crucial for the end product to be designed in a manner that minimizes the thermal resistance from the solder point to ambient in order to optimize lamp life and optical characteristics.

White



Royal Blue, Blue



Green



Amber



PC Amber



Red-Orange, Red



REFLOW SOLDERING CHARACTERISTICS

In testing, Cree has found XLamp XP-E2 LEDs to be compatible with JEDEC J-STD-020C, using the parameters listed below. As a general guideline, Cree recommends that users follow the recommended soldering profile provided by the manufacturer of the solder paste used.

Note that this general guideline may not apply to all PCB designs and configurations of reflow soldering equipment.

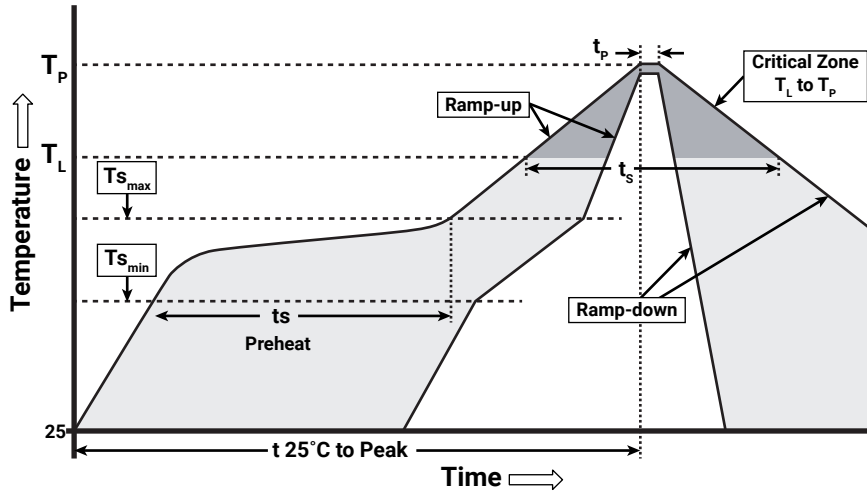

IPC/JEDEC J-STD-020C

| Profile Feature | Lead-Free Solder |
|---|------------------|
| Average Ramp-Up Rate (Ts_{max} to T_P) | 1.2 °C/second |
| Preheat: Temperature Min (Ts_{min}) | 120 °C |
| Preheat: Temperature Max (Ts_{max}) | 170 °C |
| Preheat: Time (ts_{min} to ts_{max}) | 65-150 seconds |
| Time Maintained Above: Temperature (T_L) | 217 °C |
| Time Maintained Above: Time (t_l) | 45-90 seconds |
| Peak/Classification Temperature (T_P) | 235 - 245 °C |
| Time Within 5 °C of Actual Peak Temperature (t_p) | 20-40 seconds |
| Ramp-Down Rate | 1 - 6 °C/second |
| Time 25 °C to Peak Temperature | 4 minutes max. |

Note: All temperatures refer to topside of the package, measured on the package body surface.

NOTES

Measurements

The luminous flux, radiant power, chromaticity and CRI measurements in this document are binning specifications only and solely represent product measurements as of the date of shipment. These measurements will change over time based on a number of factors that are not within Cree's control and are not intended or provided as operational specifications for the products. Calculated values are provided for informational purposes only and are not intended as specifications.

Lumen Maintenance

Cree now uses standardized IES LM-80-08 and TM-21-11 methods for collecting long-term data and extrapolating LED lumen maintenance. For information on the specific LM-80 data sets available for this LED, refer to the [LM-80 results document](#).

Please read the [Long-Term Lumen Maintenance application note](#) for more details on Cree's lumen maintenance testing and forecasting. Please read the [Thermal Management application note](#) for details on how thermal design, ambient temperature, and drive current affect the LED junction temperature.

Moisture Sensitivity

Cree recommends keeping XLamp LEDs in the provided, resealable moisture-barrier packaging (MBP) until immediately prior to soldering. Unopened MBPs that contain XLamp LEDs do not need special storage for moisture sensitivity.

Once the MBP is opened, XLamp XP-E2 LEDs may be stored as MSL 1 per JEDEC J-STD-033, meaning they have unlimited floor life in conditions of ≤ 30 °C/85% relative humidity (RH). Regardless of the storage condition, Cree recommends sealing any unsoldered LEDs in the original MBP.

RoHS Compliance

The levels of RoHS restricted materials in this product are below the maximum concentration values (also referred to as the threshold limits) permitted for such substances, or are used in an exempted application, in accordance with EU Directive 2011/65/EC (RoHS2), as implemented January 2, 2013. RoHS Declarations for this product can be obtained from your Cree representative or from the Product Documentation sections of www.cree.com.

REACH Compliance

REACH substances of very high concern (SVHCs) information is available for this product. Since the European Chemical Agency (ECHA) has published notice of their intent to frequently revise the SVHC listing for the foreseeable future, please contact a Cree representative to insure you get the most up-to-date REACH SVHC Declaration. REACH banned substance information (REACH Article 67) is also available upon request.

UL® Recognized Component

Level 4 enclosure consideration. The LED package or a portion thereof has been investigated as a fire and electrical enclosure per ANSI/UL 8750.

NOTES - CONTINUED

Vision Advisory

WARNING: Do not look at exposed lamp in operation. Eye injury can result. For more information about LEDs and eye safety, please refer to the [LED Eye Safety application note](#).

MECHANICAL DIMENSIONS

Thermal vias, if present, are not shown on these drawings.

All measurements are ± 0.13 mm unless otherwise indicated.



TAPE AND REEL

All Cree carrier tapes conform to EIA-481D, Automated Component Handling Systems Standard.

All dimensions in mm.

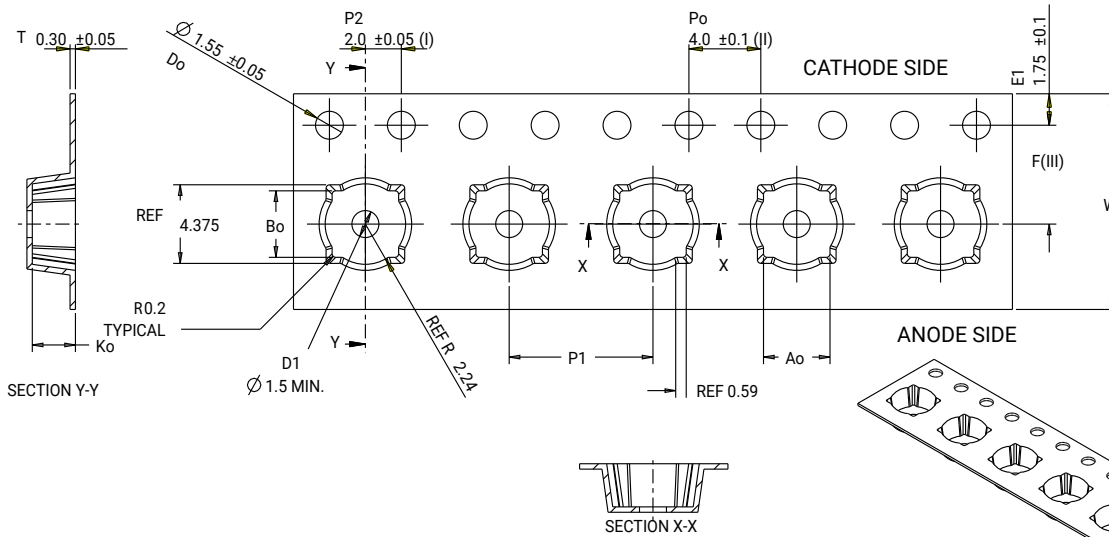

| | | |
|-----|-------|-----------|
| Ao | 3.70 | +/- 0.1 |
| Bo | 3.70 | +/- 0.1 |
| Ko | 2.40 | +0.0/-0.1 |
| F | 5.50 | +/- 0.05 |
| P 1 | 8.00 | +/- 0.1 |
| W | 12.00 | +0.3/-0.1 |

- (I) Measured from centerline of sprocket hole to centerline of pocket.
- (II) Cumulative tolerance of 10 sprocket holes is ± 0.20.
- (III) Measured from centerline of sprocket hole to centerline of pocket.
- (IV) Other material available.

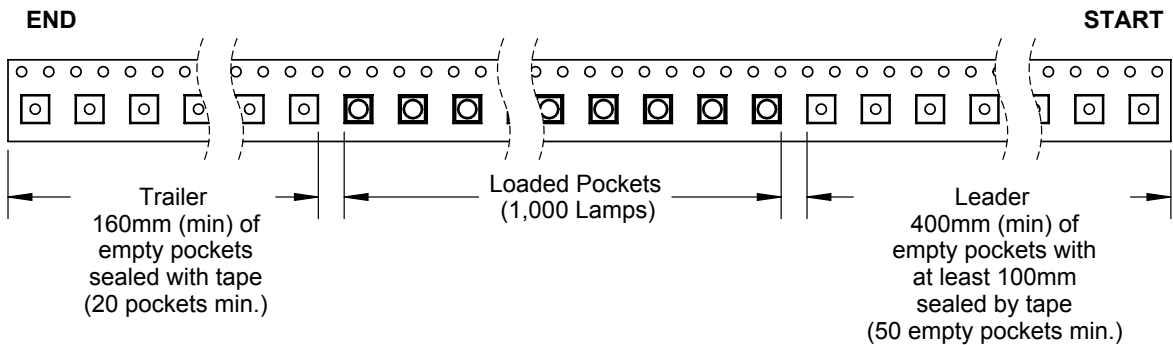

PACKAGING

Unpackaged Reel



Label with Cree Bin Code,
Quantity, Reel ID

Packaged Reel



Label with Cree Order Code,
Quantity, Reel ID, PO #

Label with Cree Bin Code,
Quantity, Reel ID

Boxed Reel

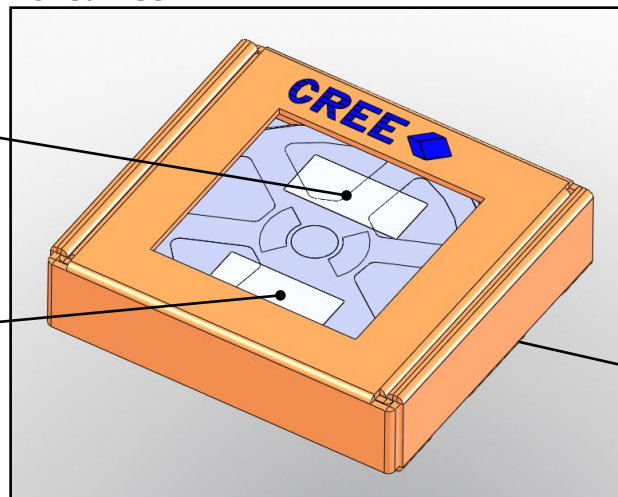

Label with Cree Order Code,
Quantity, Reel ID, PO #

Label with Cree Bin Code,
Quantity, Reel ID

Patent Label
(on bottom of box)

Компания «Life Electronics» занимается поставками электронных компонентов импортного и отечественного производства от производителей и со складов крупных дистрибьюторов Европы, Америки и Азии.

С конца 2013 года компания активно расширяет линейку поставок компонентов по направлению коаксиальный кабель, кварцевые генераторы и конденсаторы (керамические, пленочные, электролитические), за счёт заключения дистрибьюторских договоров

Мы предлагаем:

- Конкурентоспособные цены и скидки постоянным клиентам.
- Специальные условия для постоянных клиентов.
- Подбор аналогов.
- Поставку компонентов в любых объемах, удовлетворяющих вашим потребностям.
- Приемлемые сроки поставки, возможна ускоренная поставка.
- Доставку товара в любую точку России и стран СНГ.
- Комплексную поставку.
- Работу по проектам и поставку образцов.
- Формирование склада под заказчика.
- Сертификаты соответствия на поставляемую продукцию (по желанию клиента).
- Тестирование поставляемой продукции.
- Поставку компонентов, требующих военную и космическую приемку.
- Входной контроль качества.
- Наличие сертификата ISO.

В составе нашей компании организован Конструкторский отдел, призванный помогать разработчикам, и инженерам.

Конструкторский отдел помогает осуществить:

- Регистрацию проекта у производителя компонентов.
- Техническую поддержку проекта.
- Защиту от снятия компонента с производства.
- Оценку стоимости проекта по компонентам.
- Изготовление тестовой платы монтаж и пусконаладочные работы.



Тел: +7 (812) 336 43 04 (многоканальный)

Email: org@lifeelectronics.ru