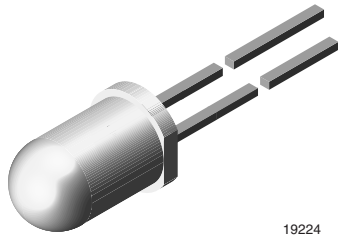


High Efficiency LED, Ø 5 mm Tinted Non-Diffused Package



19224

DESCRIPTION

The TLH.620. series was developed for standard applications like general indicating and lighting purposes.

It is housed in a 5 mm tinted non-diffused plastic package. The small viewing angle of these devices provides a high brightness.

Several selection types with different luminous intensities are offered. All LEDs are categorized in luminous intensity groups. The green and yellow LEDs are categorized additionally in wavelength groups.

That allows users to assemble LEDs with uniform appearance.

FEATURES

- Choice of three bright colors
- Standard T-1³/₄ package
- Small mechanical tolerances
- Suitable for DC and high peak current
- Small viewing angle
- Luminous intensity categorized
- Yellow and green color categorized
- TLH.620. without stand-offs
- Compliant to RoHS directive 2002/95/EC and in accordance to WEEE 2002/96/EC


RoHS
COMPLIANT

APPLICATIONS

- Status lights
- Off/on indicator
- Background illumination
- Readout lights
- Maintenance lights
- Legend light

PRODUCT GROUP AND PACKAGE DATA

- Product group: LED
- Package: 5 mm
- Product series: standard
- Angle of half intensity: ± 14°

PARTS TABLE		
PART	COLOR, LUMINOUS INTENSITY	TECHNOLOGY
TLHG6200	Green, I _V = 40 mcd (typ.)	GaP on GaP
TLHG6200-CS12	Green, I _V = 40 mcd (typ.)	GaP on GaP
TLHG6200-CS12Z	Green, I _V = 40 mcd (typ.)	GaP on GaP
TLHR6200-CS12	Red, I _V = 50 mcd (typ.)	GaAsP on GaP
TLHR6200-CS12Z	Red, I _V = 50 mcd (typ.)	GaAsP on GaP
TLHR6205	Red, I _V = 70 mcd (typ.)	GaAsP on GaP
TLHY6200-CS12	Yellow, I _V = 50 mcd (typ.)	GaAsP on GaP
TLHY6200-CS12Z	Yellow, I _V = 50 mcd (typ.)	GaAsP on GaP

ABSOLUTE MAXIMUM RATINGS ¹⁾ TLHR620. TLHY620. , TLHG620.				
PARAMETER	TEST CONDITION	SYMBOL	VALUE	UNIT
Reverse voltage		V_R	6	V
DC Forward current	$T_{amb} \leq 65\text{ }^\circ\text{C}$	I_F	30	mA
Surge forward current	$t_p \leq 10\text{ }\mu\text{s}$	I_{FSM}	1	A
Power dissipation	$T_{amb} \leq 65\text{ }^\circ\text{C}$	P_V	100	mW
Junction temperature		T_j	100	$^\circ\text{C}$
Operating temperature range		T_{amb}	- 20 to + 100	$^\circ\text{C}$
Storage temperature range		T_{stg}	- 55 to + 100	$^\circ\text{C}$
Soldering temperature	$t \leq 5\text{ s, 2 mm from body}$	T_{sd}	260	$^\circ\text{C}$
Thermal resistance junction/ambient		R_{thJA}	350	K/W

Note:

¹⁾ $T_{amb} = 25\text{ }^\circ\text{C}$, unless otherwise specified

OPTICAL AND ELECTRICAL CHARACTERISTICS ¹⁾ TLHR620., RED							
PARAMETER	TEST CONDITION	PART	SYMBOL	MIN.	TYP.	MAX.	UNIT
Luminous intensity ²⁾	$I_F = 10\text{ mA}$	TLHR6200	I_V	10	50		mcd
		TLHR6205	I_V	25	70		mcd
Dominant wavelength	$I_F = 10\text{ mA}$		λ_d	612		625	nm
Peak wavelength	$I_F = 10\text{ mA}$		λ_p		635		nm
Angle of half intensity	$I_F = 10\text{ mA}$		φ		± 14		deg
Forward voltage	$I_F = 20\text{ mA}$		V_F		2	3	V
Reverse voltage	$I_R = 10\text{ }\mu\text{A}$		V_R	6	15		V
Junction capacitance	$V_R = 0, f = 1\text{ MHz}$		C_j		50		pF

Note:

¹⁾ $T_{amb} = 25\text{ }^\circ\text{C}$, unless otherwise specified

²⁾ In one packing unit $I_{Vmin.}/I_{Vmax.} \leq 0.5$

OPTICAL AND ELECTRICAL CHARACTERISTICS ¹⁾ TLHY620., YELLOW							
PARAMETER	TEST CONDITION	PART	SYMBOL	MIN.	TYP.	MAX.	UNIT
Luminous intensity ²⁾	$I_F = 10\text{ mA}$	TLHY6200	I_V	10	50		mcd
Dominant wavelength	$I_F = 10\text{ mA}$		λ_d	581		594	nm
Peak wavelength	$I_F = 10\text{ mA}$		λ_p		585		nm
Angle of half intensity	$I_F = 10\text{ mA}$		φ		± 14		deg
Forward voltage	$I_F = 20\text{ mA}$		V_F		2.4	3	V
Reverse voltage	$I_R = 10\text{ }\mu\text{A}$		V_R	6	15		V
Junction capacitance	$V_R = 0, f = 1\text{ MHz}$		C_j		50		pF

Note:

¹⁾ $T_{amb} = 25\text{ }^\circ\text{C}$, unless otherwise specified

²⁾ In one packing unit $I_{Vmin.}/I_{Vmax.} \leq 0.5$

OPTICAL AND ELECTRICAL CHARACTERISTICS ¹⁾ TLHG620., GREEN							
PARAMETER	TEST CONDITION	PART	SYMBOL	MIN.	TYP.	MAX.	UNIT
Luminous intensity ²⁾	$I_F = 10 \text{ mA}$	TLHG6200	I_V	16	40		mcd
Dominant wavelength	$I_F = 10 \text{ mA}$		λ_d	562		575	nm
Peak wavelength	$I_F = 10 \text{ mA}$		λ_p		565		nm
Angle of half intensity	$I_F = 10 \text{ mA}$		ϕ		± 14		deg
Forward voltage	$I_F = 20 \text{ mA}$		V_F		2.4	3	V
Reverse voltage	$I_R = 10 \mu\text{A}$		V_R	6	15		V
Junction capacitance	$V_R = 0, f = 1 \text{ MHz}$		C_j		50		pF

Note:

¹⁾ $T_{amb} = 25 \text{ }^\circ\text{C}$, unless otherwise specified

²⁾ In one packing unit $I_{Vmin.}/I_{Vmax.} \leq 0.5$

TYPICAL CHARACTERISTICS

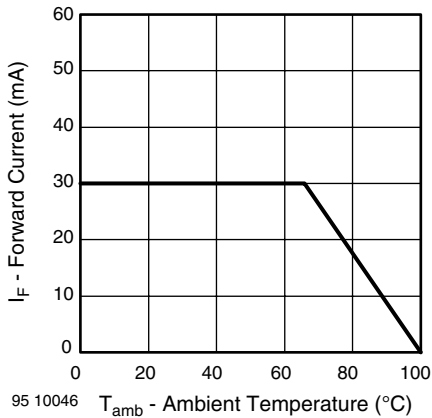
 $T_{amb} = 25 \text{ }^\circ\text{C}$, unless otherwise specified


Figure 1. Forward Current vs. Ambient Temperature

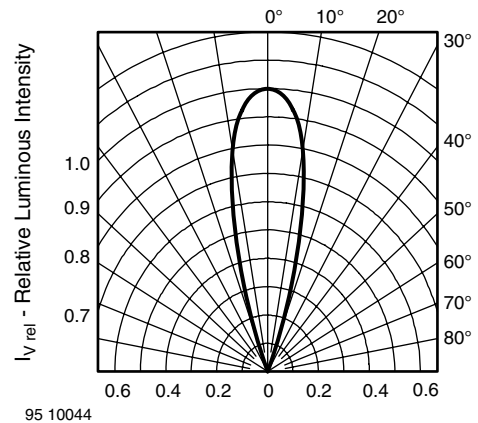


Figure 3. Rel. Luminous Intensity vs. Angular Displacement

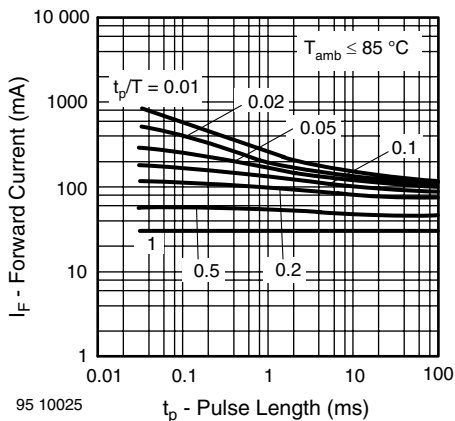


Figure 2. Forward Current vs. Pulse Length

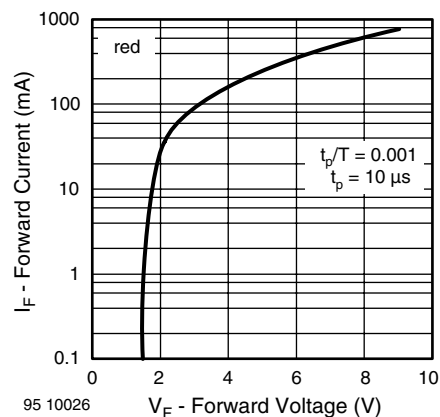


Figure 4. Forward Current vs. Forward Voltage

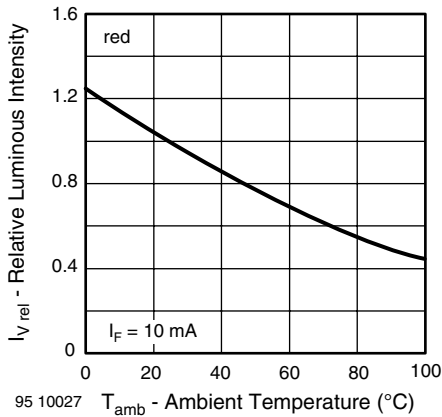


Figure 5. Rel. Luminous Intensity vs. Ambient Temperature

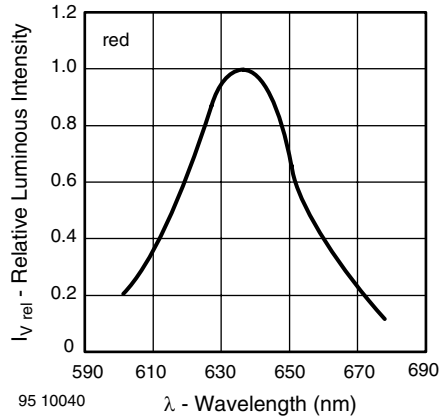


Figure 8. Relative Intensity vs. Wavelength

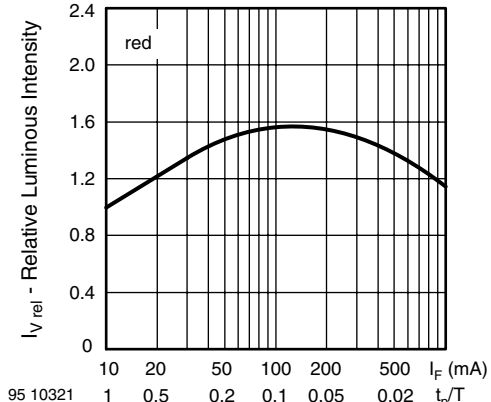


Figure 6. Rel. Lumin. Intensity vs. Forw. Current/Duty Cycle

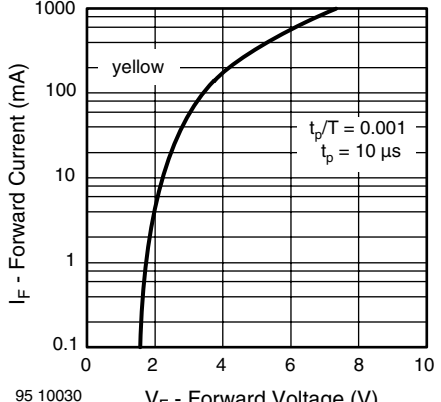


Figure 9. Forward Current vs. Forward Voltage

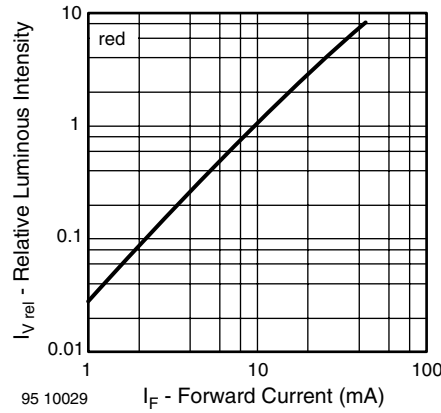


Figure 7. Relative Luminous Intensity vs. Forward Current

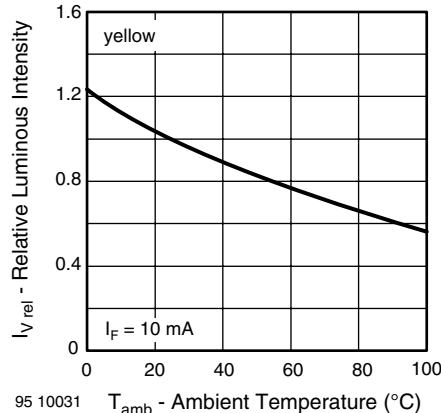


Figure 10. Rel. Luminous Intensity vs. Ambient Temperature

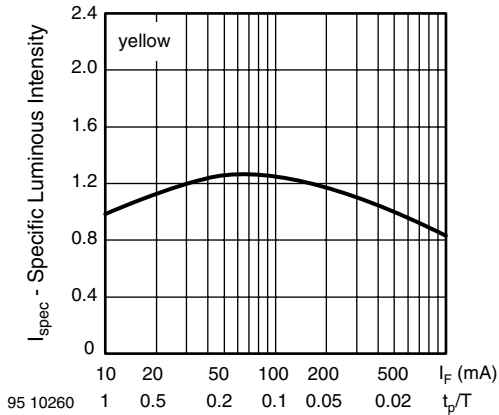


Figure 11. Rel. Lumin. Intensity vs. Forw. Current/Duty Cycle

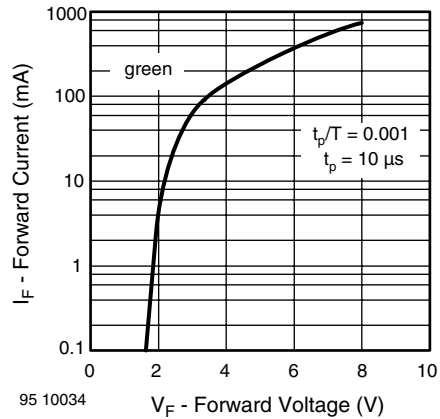


Figure 14. Forward Current vs. Forward Voltage

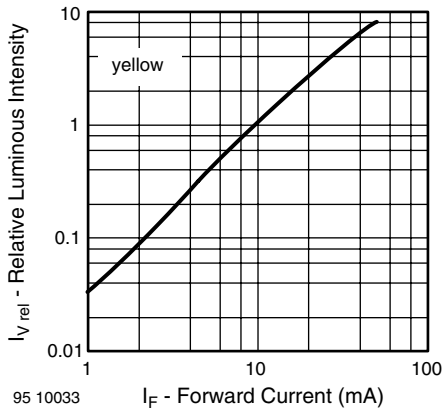


Figure 12. Relative Luminous Intensity vs. Forward Current

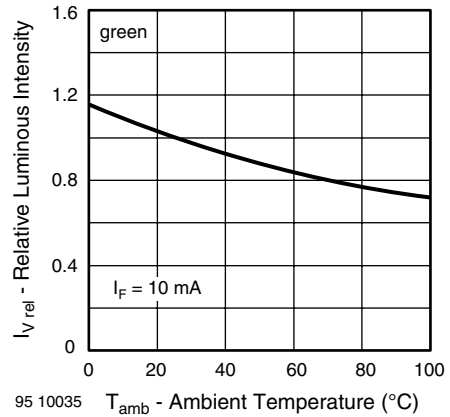


Figure 15. Rel. Luminous Intensity vs. Ambient Temperature

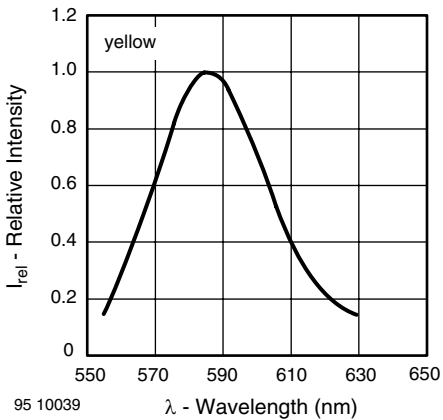


Figure 13. Relative Intensity vs. Wavelength

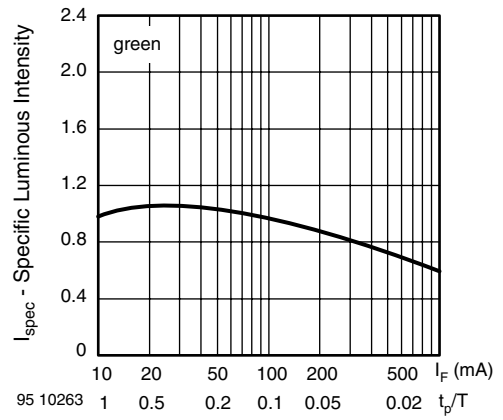


Figure 16. Specific Luminous Intensity vs. Forward Current

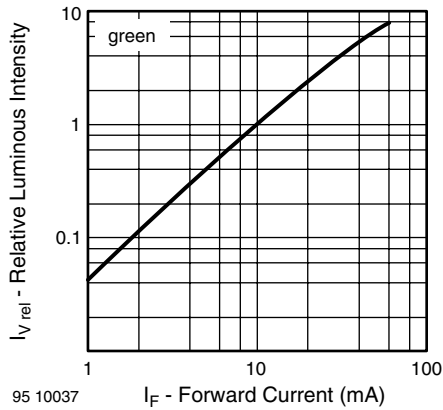


Figure 17. Relative Luminous Intensity vs. Forward Current

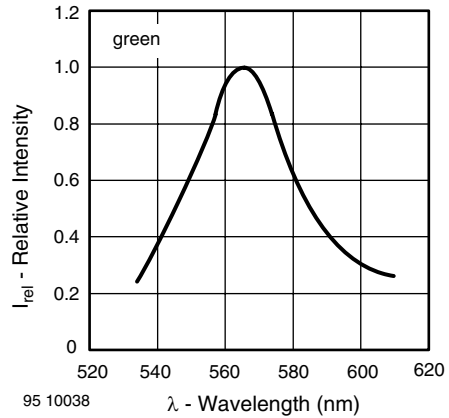
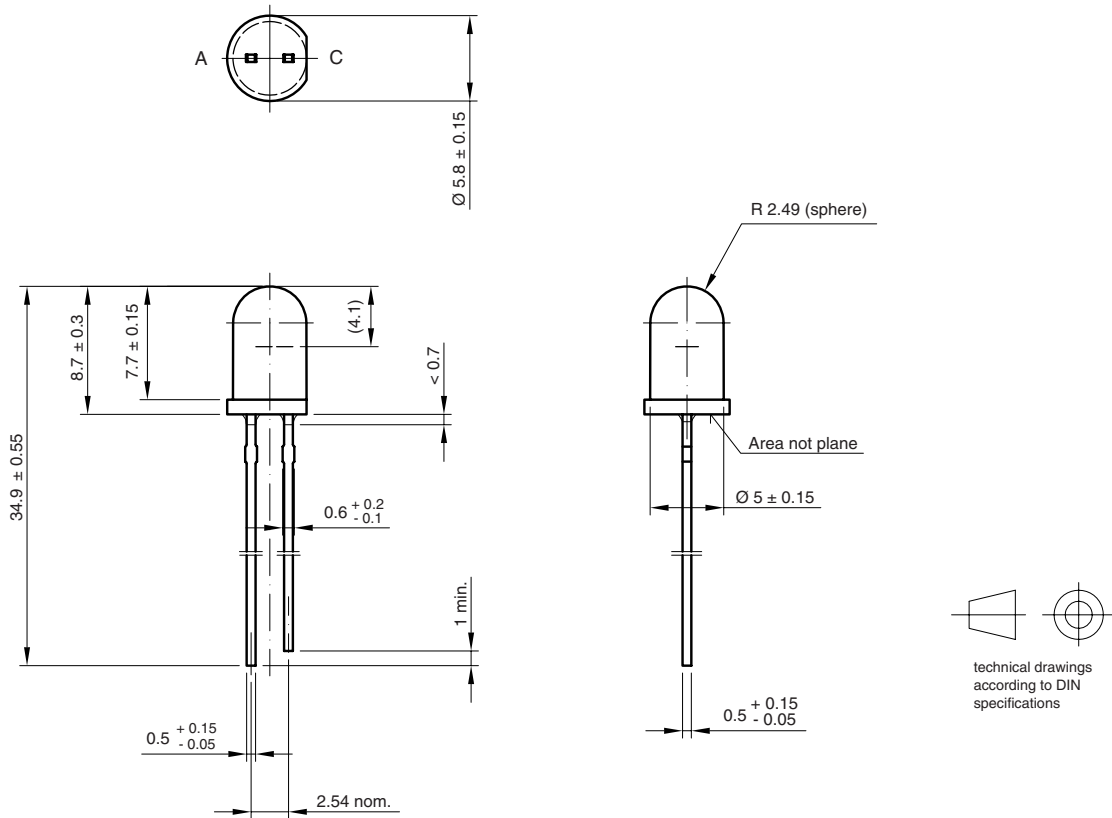


Figure 18. Relative Intensity vs. Wavelength

PACKAGE DIMENSIONS in millimeters



6.544-5259.01-4
 Issue: 4; 19.05.09
 96 12123

REEL



Figure 19. Reel Dimensions

AS12 = cathode leaves tape first
AS21 = anode leaves tape first

AMMOPACK

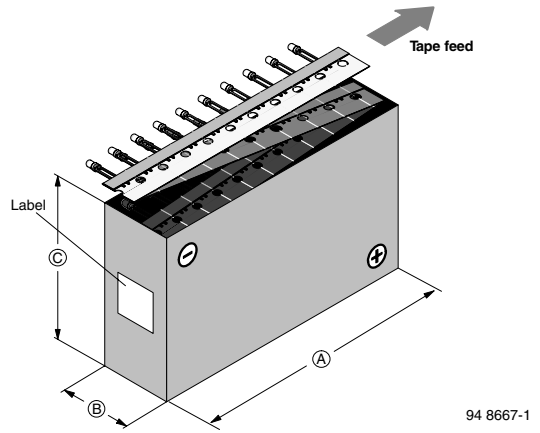


Figure 21. Tape Direction

Note:
AS12Z and AS21Z still valid for already existing types BUT NOT FOR NEW DESIGN

TAPE

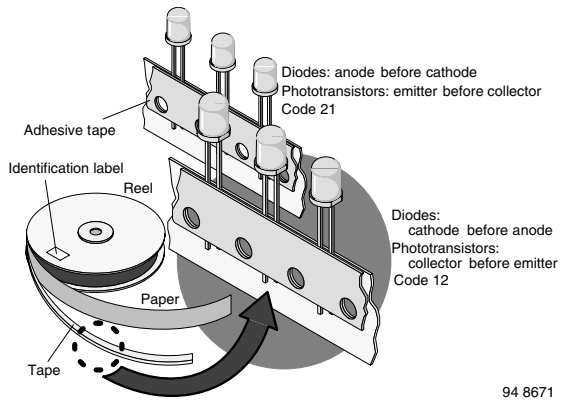


Figure 20. LED in Tape

TAPE DIMENSIONS



Quantity per:	Reel (Mat.-no. 1764)
	1000

94 8172

Option	Dim. "H" ± 0.5 mm
CS	22.0



Disclaimer

ALL PRODUCT, PRODUCT SPECIFICATIONS AND DATA ARE SUBJECT TO CHANGE WITHOUT NOTICE TO IMPROVE RELIABILITY, FUNCTION OR DESIGN OR OTHERWISE.

Vishay Intertechnology, Inc., its affiliates, agents, and employees, and all persons acting on its or their behalf (collectively, "Vishay"), disclaim any and all liability for any errors, inaccuracies or incompleteness contained in any datasheet or in any other disclosure relating to any product.

Vishay makes no warranty, representation or guarantee regarding the suitability of the products for any particular purpose or the continuing production of any product. To the maximum extent permitted by applicable law, Vishay disclaims (i) any and all liability arising out of the application or use of any product, (ii) any and all liability, including without limitation special, consequential or incidental damages, and (iii) any and all implied warranties, including warranties of fitness for particular purpose, non-infringement and merchantability.

Statements regarding the suitability of products for certain types of applications are based on Vishay's knowledge of typical requirements that are often placed on Vishay products in generic applications. Such statements are not binding statements about the suitability of products for a particular application. It is the customer's responsibility to validate that a particular product with the properties described in the product specification is suitable for use in a particular application. Parameters provided in datasheets and/or specifications may vary in different applications and performance may vary over time. All operating parameters, including typical parameters, must be validated for each customer application by the customer's technical experts. Product specifications do not expand or otherwise modify Vishay's terms and conditions of purchase, including but not limited to the warranty expressed therein.

Except as expressly indicated in writing, Vishay products are not designed for use in medical, life-saving, or life-sustaining applications or for any other application in which the failure of the Vishay product could result in personal injury or death. Customers using or selling Vishay products not expressly indicated for use in such applications do so at their own risk. Please contact authorized Vishay personnel to obtain written terms and conditions regarding products designed for such applications.

No license, express or implied, by estoppel or otherwise, to any intellectual property rights is granted by this document or by any conduct of Vishay. Product names and markings noted herein may be trademarks of their respective owners.

Material Category Policy

Vishay Intertechnology, Inc. hereby certifies that all its products that are identified as RoHS-Compliant fulfill the definitions and restrictions defined under Directive 2011/65/EU of The European Parliament and of the Council of June 8, 2011 on the restriction of the use of certain hazardous substances in electrical and electronic equipment (EEE) - recast, unless otherwise specified as non-compliant.

Please note that some Vishay documentation may still make reference to RoHS Directive 2002/95/EC. We confirm that all the products identified as being compliant to Directive 2002/95/EC conform to Directive 2011/65/EU.

Vishay Intertechnology, Inc. hereby certifies that all its products that are identified as Halogen-Free follow Halogen-Free requirements as per JEDEC JS709A standards. Please note that some Vishay documentation may still make reference to the IEC 61249-2-21 definition. We confirm that all the products identified as being compliant to IEC 61249-2-21 conform to JEDEC JS709A standards.

Компания «Life Electronics» занимается поставками электронных компонентов импортного и отечественного производства от производителей и со складов крупных дистрибьюторов Европы, Америки и Азии.

С конца 2013 года компания активно расширяет линейку поставок компонентов по направлению коаксиальный кабель, кварцевые генераторы и конденсаторы (керамические, пленочные, электролитические), за счёт заключения дистрибьюторских договоров

Мы предлагаем:

- Конкурентоспособные цены и скидки постоянным клиентам.
- Специальные условия для постоянных клиентов.
- Подбор аналогов.
- Поставку компонентов в любых объемах, удовлетворяющих вашим потребностям.
- Приемлемые сроки поставки, возможна ускоренная поставка.
- Доставку товара в любую точку России и стран СНГ.
- Комплексную поставку.
- Работу по проектам и поставку образцов.
- Формирование склада под заказчика.
- Сертификаты соответствия на поставляемую продукцию (по желанию клиента).
- Тестирование поставляемой продукции.
- Поставку компонентов, требующих военную и космическую приемку.
- Входной контроль качества.
- Наличие сертификата ISO.

В составе нашей компании организован Конструкторский отдел, призванный помогать разработчикам, и инженерам.

Конструкторский отдел помогает осуществить:

- Регистрацию проекта у производителя компонентов.
- Техническую поддержку проекта.
- Защиту от снятия компонента с производства.
- Оценку стоимости проекта по компонентам.
- Изготовление тестовой платы монтаж и пусконаладочные работы.



Тел: +7 (812) 336 43 04 (многоканальный)

Email: org@lifeelectronics.ru