



preliminary

# Sonic Fast Recovery Diode

$V_{RRM} = 1200\text{ V}$   
 $I_{DAV} = 34\text{ A}$   
 $t_{rr} = 150\text{ ns}$

High Performance Fast Recovery Diode  
 Low Loss and Soft Recovery  
 1~ Rectifier Bridge

Part number

**DHG40B1200LB**

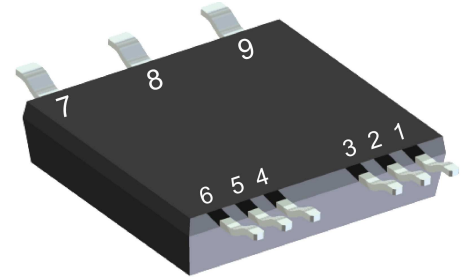

Backside: isolated

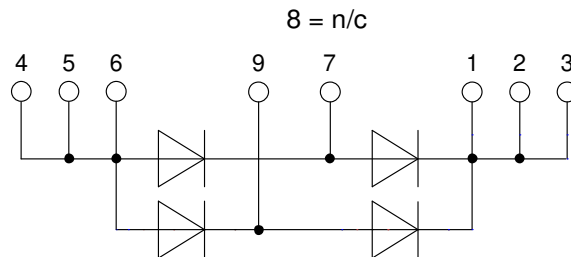
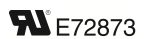

### Features / Advantages:

- Planar passivated chips
- Very low leakage current
- Very short recovery time
- Improved thermal behaviour
- Very low  $I_{rm}$ -values
- Very soft recovery behaviour
- Avalanche voltage rated for reliable operation
- Soft reverse recovery for low EMI/RFI
- Low  $I_{rm}$  reduces:
  - Power dissipation within the diode
  - Turn-on loss in the commutating switch

### Applications:

- Antiparallel diode for high frequency switching devices
- Antisaturation diode
- Snubber diode
- Free wheeling diode
- Rectifiers in switch mode power supplies (SMPS)
- Uninterruptible power supplies (UPS)

### Package: SMPD

- Isolation Voltage: 3000 V~
- Industry convenient outline
- RoHS compliant
- Epoxy meets UL 94V-0
- Soldering pins for PCB mounting
- Backside: DCB ceramic
- Reduced weight
- Advanced power cycling

### Disclaimer Notice

Information furnished is believed to be accurate and reliable. However, users should independently evaluate the suitability of and test each product selected for their own applications. Littelfuse products are not designed for, and may not be used in, all applications. Read complete Disclaimer Notice at [www.littelfuse.com/disclaimer-electronics](http://www.littelfuse.com/disclaimer-electronics).



Fast Diode				Ratings			
Symbol	Definition	Conditions	min.	typ.	max.	Unit	
$V_{RSM}$	max. non-repetitive reverse blocking voltage	$T_{VJ} = 25^{\circ}C$			1200	V	
$V_{RRM}$	max. repetitive reverse blocking voltage	$T_{VJ} = 25^{\circ}C$			1200	V	
$I_R$	reverse current, drain current	$V_R = 1200\text{ V}$	$T_{VJ} = 25^{\circ}C$		40	$\mu A$	
		$V_R = 1200\text{ V}$	$T_{VJ} = 125^{\circ}C$		0.4	mA	
$V_F$	forward voltage drop	$I_F = 20\text{ A}$	$T_{VJ} = 25^{\circ}C$		2.24	V	
		$I_F = 40\text{ A}$			2.89	V	
		$I_F = 20\text{ A}$	$T_{VJ} = 125^{\circ}C$		2.24	V	
		$I_F = 40\text{ A}$			3.15	V	
$I_{DAV}$	bridge output current	$T_C = 80^{\circ}C$ rectangular $d = 0.5$	$T_{VJ} = 150^{\circ}C$		34	A	
$V_{FO}$	threshold voltage	} for power loss calculation only	$T_{VJ} = 150^{\circ}C$		1.35	V	
$r_F$	slope resistance				43	m $\Omega$	
$R_{thJC}$	thermal resistance junction to case				1.5	K/W	
$R_{thCH}$	thermal resistance case to heatsink			0.50		K/W	
$P_{tot}$	total power dissipation		$T_C = 25^{\circ}C$		80	W	
$I_{FSM}$	max. forward surge current	$t = 10\text{ ms}; (50\text{ Hz}), \text{ sine}; V_R = 0\text{ V}$	$T_{VJ} = 45^{\circ}C$		150	A	
$C_J$	junction capacitance	$V_R = 600\text{ V}$ $f = 1\text{ MHz}$	$T_{VJ} = 25^{\circ}C$		8	pF	
$I_{RM}$	max. reverse recovery current	} $I_F = 15\text{ A}; V_R = 600\text{ V}$ $-di_F/dt = 600\text{ A}/\mu\text{s}$	$T_{VJ} = 25^{\circ}C$		15	A	
			$T_{VJ} = 125^{\circ}C$		20	A	
$t_{rr}$	reverse recovery time		$T_{VJ} = 25^{\circ}C$		150	ns	
			$T_{VJ} = 125^{\circ}C$		250	ns	



preliminary

Package SMPD		Ratings				
Symbol	Definition	Conditions	min.	typ.	max.	Unit
$I_{RMS}$	RMS current	per terminal			100	A
$T_{VJ}$	virtual junction temperature		-55		150	°C
$T_{op}$	operation temperature		-55		125	°C
$T_{stg}$	storage temperature		-55		150	°C
<b>Weight</b>				8.5		g
$F_C$	mounting force with clip		40		130	N
$d_{Spp/ App}$	creepage distance on surface / striking distance through air	terminal to terminal	1.6			mm
$d_{Spb/ Apb}$		terminal to backside	4.0			mm
$V_{ISOL}$	isolation voltage	t = 1 second	3000			V
		t = 1 minute	2500			V

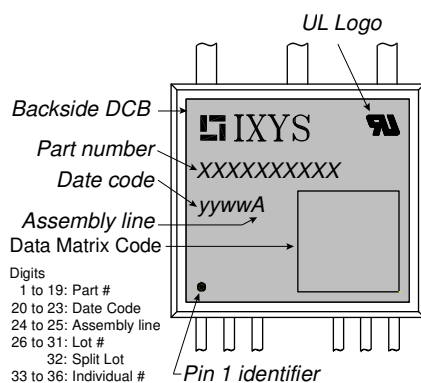

**Part description**

- D = Diode
- H = Sonic Fast Recovery Diode
- G = extreme fast
- 40 = Current Rating [A]
- B = 1~ Rectifier Bridge
- 1200 = Reverse Voltage [V]
- LB = SMPD-B

Ordering	Ordering Number	Marking on Product	Delivery Mode	Quantity	Code No.
Standard	DHG40B1200LB-TUB	DHG40B1200LB-TUB	Tube	20	525198
Alternative	DHG40B1200LB-TRR	DHG40B1200LB	Tape & Reel	200	524922

**Equivalent Circuits for Simulation**

\* on die level

$T_{VJ} = 150\text{ °C}$

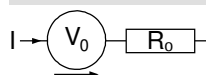

Symbol	Definition	Value	Unit
$V_{0\ max}$	threshold voltage	1.35	V
$R_{0\ max}$	slope resistance *	41	mΩ



Outlines SMPD

A ( 8 : 1 )

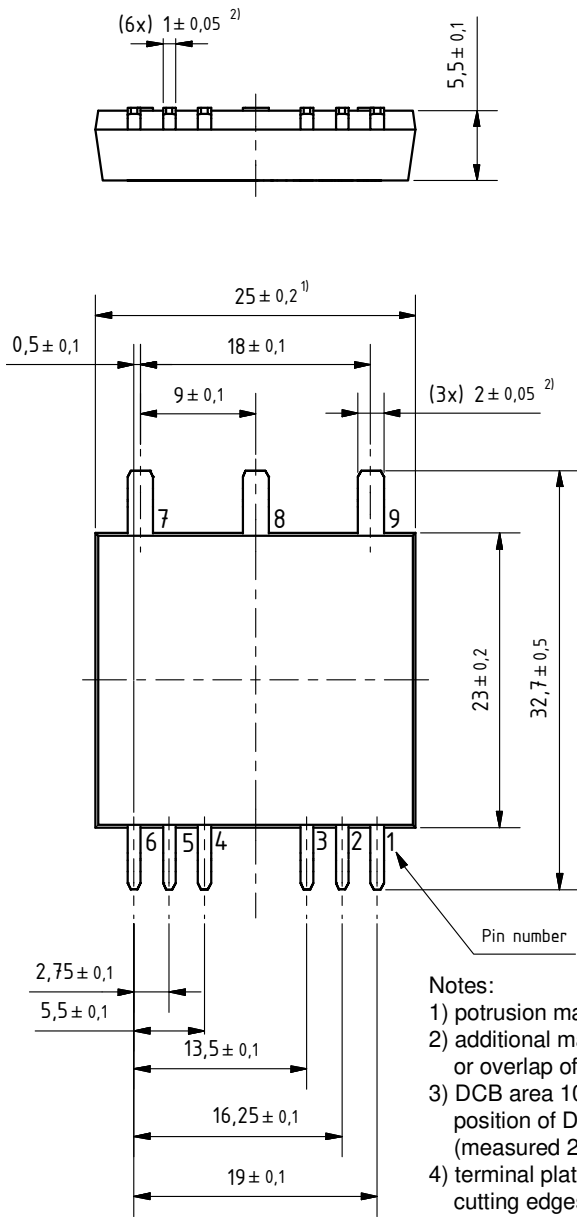

Notes:

- 1) protusion may add 0.2 mm max. on each side
- 2) additional max. 0.05 mm per side by punching misalignment or overlap of dam bar or bending compression
- 3) DCB area 10 to 50  $\mu\text{m}$  convex; position of DCB area in relation to plastic rim:  $\pm 25 \mu\text{m}$  (measured 2 mm from Cu rim)
- 4) terminal plating: 0.2 - 1  $\mu\text{m}$  Ni + 10 - 25  $\mu\text{m}$  Sn (gal v.) cutting edges may be partially free of plating

$8 = n/c$

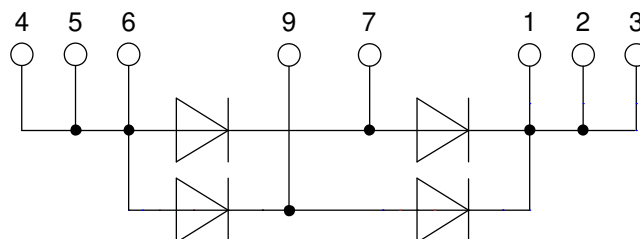

Компания «Life Electronics» занимается поставками электронных компонентов импортного и отечественного производства от производителей и со складов крупных дистрибьюторов Европы, Америки и Азии.

С конца 2013 года компания активно расширяет линейку поставок компонентов по направлению коаксиальный кабель, кварцевые генераторы и конденсаторы (керамические, пленочные, электролитические), за счёт заключения дистрибьюторских договоров

Мы предлагаем:

- Конкурентоспособные цены и скидки постоянным клиентам.
- Специальные условия для постоянных клиентов.
- Подбор аналогов.
- Поставку компонентов в любых объемах, удовлетворяющих вашим потребностям.
- Приемлемые сроки поставки, возможна ускоренная поставка.
- Доставку товара в любую точку России и стран СНГ.
- Комплексную поставку.
- Работу по проектам и поставку образцов.
- Формирование склада под заказчика.
- Сертификаты соответствия на поставляемую продукцию (по желанию клиента).
- Тестирование поставляемой продукции.
- Поставку компонентов, требующих военную и космическую приемку.
- Входной контроль качества.
- Наличие сертификата ISO.

В составе нашей компании организован Конструкторский отдел, призванный помогать разработчикам, и инженерам.

Конструкторский отдел помогает осуществить:

- Регистрацию проекта у производителя компонентов.
- Техническую поддержку проекта.
- Защиту от снятия компонента с производства.
- Оценку стоимости проекта по компонентам.
- Изготовление тестовой платы монтаж и пусконаладочные работы.



Тел: +7 (812) 336 43 04 (многоканальный)  
Email: [org@lifeelectronics.ru](mailto:org@lifeelectronics.ru)