

Features

- Formerly **FulTec** brand
- Extremely high speed performance
- Blocks high voltages and currents
- Very high bandwidth; GHz compatible
- Small package, minimal PCB area
- Simple, superior circuit protection
- RoHS compliant*, UL Recognized



The C650 & C850 Series are currently available, but not recommended for new designs. Bourns® TBU-CA Series is preferred.

C650 and C850 Series TBU® High-Speed Protectors

Transient Blocking Units - TBU® Devices

Bourns® C650 and C850 series products are high-speed bidirectional protection components, constructed using MOSFET semiconductor technology, designed to protect against faults caused by short circuits, AC power cross, induction and lightning surges.

The TBU® high-speed protector, triggering as a function of the MOSFET, blocks surges and provides an effective barrier behind which sensitive electronics are not exposed to large voltages or currents during surge events. The TBU® device is provided in a surface mount DFN package and meets industry standard requirements such as RoHS and Pb Free solder reflow profiles.

Agency Approval

UL recognized component File # E315805.

Industry Standards

Description			Model
Telcordia	GR-1089	Port Type 1, 3, 5	C650 C850
	GR-974		C650 C850
ITU-T	K.20, K.20E, K.21, K.21E, K.45		C850

Absolute Maximum Ratings ($T_{amb} = 25\text{ }^{\circ}\text{C}$)

Symbol	Parameter		Value	Unit
V_{imp}	Maximum protection voltage for impulse faults with rise time $\geq 1\text{ }\mu\text{sec}$	C650-xxx-WH	650	V
		C850-xxx-WH	850	
V_{rms}	Maximum protection voltage for continuous V_{rms} faults	C650-xxx-WH	300	V
		C850-xxx-WH	425	
T_{op}	Operating temperature range		-40 to +85	$^{\circ}\text{C}$
T_{stg}	Storage temperature range		-65 to +150	$^{\circ}\text{C}$

Electrical Characteristics ($T_{amb} = 25\text{ }^{\circ}\text{C}$)

Symbol	Parameter		Min.	Typ.	Max.	Unit
I_{op}	Maximum current through the device that will not cause current blocking	Cx50-100-WH Cx50-180-WH Cx50-260-WH			100 180 260	mA
$I_{trigger}$	Typical current for the device to go from normal operating state to protected state	Cx50-100-WH Cx50-180-WH Cx50-260-WH		150 220 330		mA
I_{out}	Maximum current through the device	Cx50-100-WH Cx50-180-WH Cx50-260-WH			200 360 520	mA
R_{device}	Series resistance of the TBU® device	C650-100-WH		12	14.5	Ω
		C650-180-WH		8	10	
		C650-260-WH		8	10	
		C850-100-WH		17	19	
		C850-180-WH		11	14	
		C850-260-WH		11	14	
t_{block}	Maximum time for the device to go from normal operating state to protected state				1	μs
$I_{quiescent}$	Current through the triggered TBU® device with 50 Vdc circuit voltage			1		mA
V_{reset}	Voltage below which the triggered TBU® device will transition to normal operating state			14		V

C650 and C850 TBU® High-Speed Protectors are bidirectional; specifications are valid in both directions.

*RoHS Directive 2002/95/EC Jan. 27, 2003 including annex and RoHS Recast 2011/65/EU June 8, 2011. Specifications are subject to change without notice. Customers should verify actual device performance in their specific applications.

Applications

- Combo voice / xDSL linecards
- Voice linecards
- MDF, primary protection modules
- Process control equipment
- Test and measurement equipment
- General electronics

C650 and C850 Series TBU® High-Speed Protectors

BOURNS®

Typical Performance Characteristics

V-I Characteristics

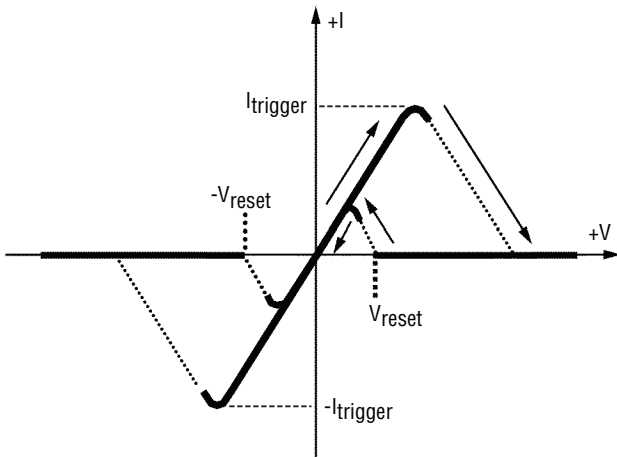

Time to Block vs. Fault Current

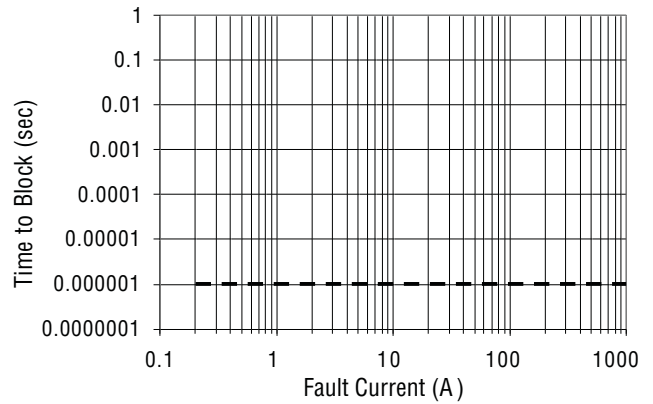

Current vs. Temperature

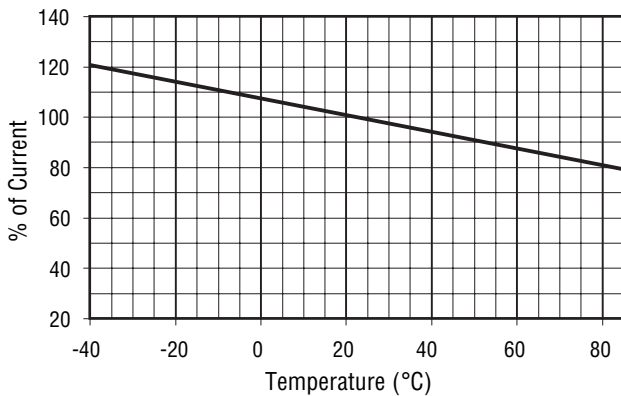

C650 and C850 Series TBU® High-Speed Protectors

BOURNS®

Operational Characteristics

The graphs below demonstrate the operational characteristics of the TBU® protector. For each graph the fault voltage, protected side voltage, and current is presented.

TEST CONFIGURATION DIAGRAM

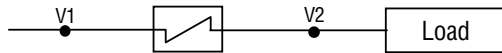

C650 Lightning, 650 V

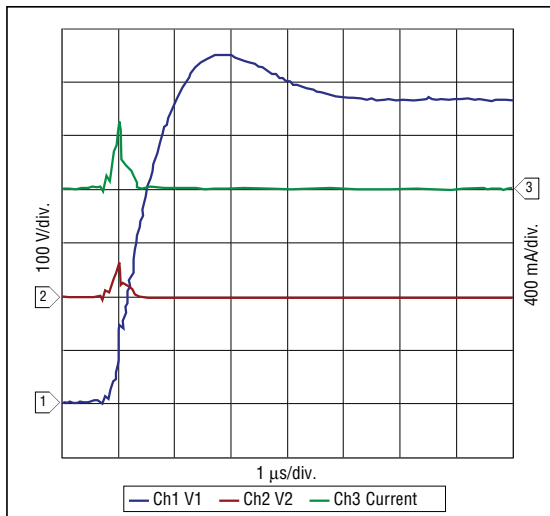

C850 Lightning, 850 V

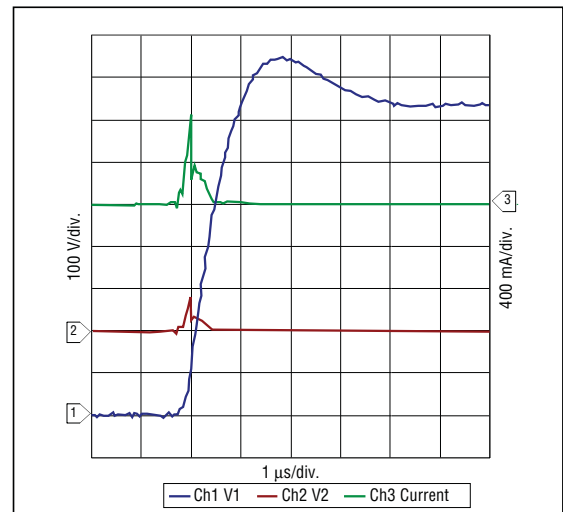

C650 Power Fault, 300 Vrms, 100 A

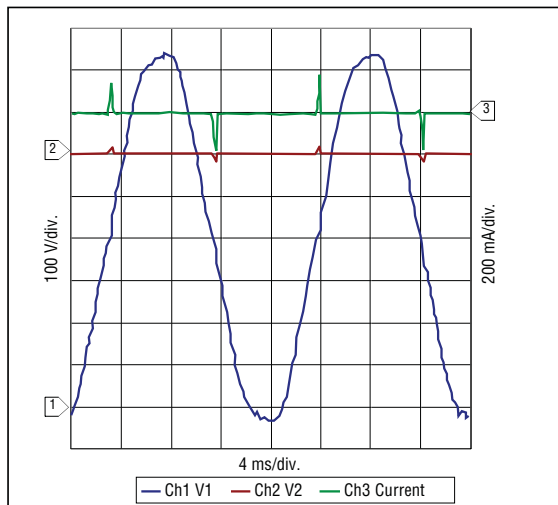

C850 Power Fault, 425 Vrms, 100 A

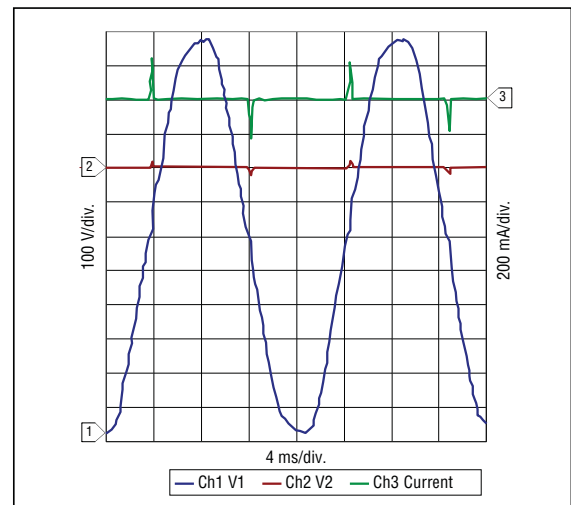

C650 and C850 Series TBU® High-Speed Protectors

BOURNS®

Product Dimensions

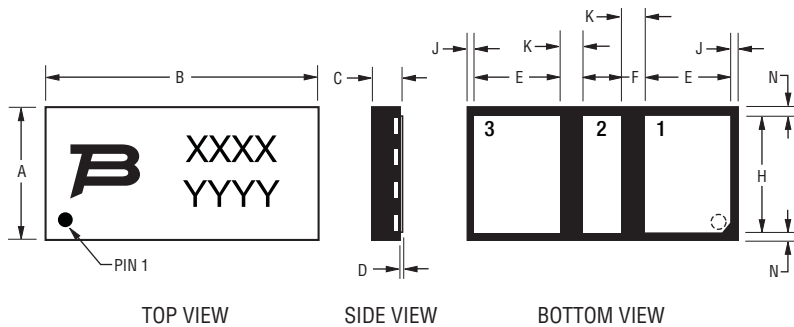

Dim.	Min.	Typ.	Max.
A	3.90 (.154)	4.00 (.157)	4.10 (.161)
B	8.15 (.321)	8.25 (.325)	8.35 (.329)
C	0.80 (.031)	0.85 (.033)	0.90 (.035)
D	0.000 (.000)	0.025 (.001)	0.050 (.002)
E	2.55 (.100)	2.60 (.102)	2.65 (.104)
F	1.10 (.043)	1.15 (.045)	1.20 (.047)
H	3.45 (.136)	3.50 (.138)	3.55 (.140)
J	0.20 (.008)	0.25 (.010)	0.30 (.012)
K	0.65 (.026)	0.70 (.028)	0.75 (.030)
N	0.20 (.008)	0.25 (.010)	0.30 (.012)

Recommended Pad Layout

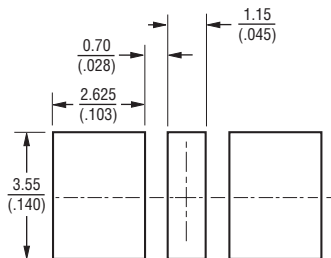

Pad Designation

Pad #	Apply
1	In/Out
2	NC
3	In/Out

NC = Solder to PCB; do not make electrical connection, do not connect to ground.

DIMENSIONS: $\frac{\text{MM}}{\text{(INCHES)}}$

TBU® protectors have matte-tin termination finish. Suggested layout should use non-solder mask define (NSMD). Recommended stencil thickness is 0.10-0.12 mm (.004-.005 in.) with stencil opening size 0.025 mm (.0010 in.) less than the device pad size. As when heat sinking any power device, it is recommended that, wherever possible, extra PCB copper area is allowed. For minimum parasitic capacitance, do not allow any signal, ground or power signals beneath any of the pads of the device.

Thermal Resistances

Symbol	Parameter	Value	Unit
$R_{th(j-a)}$	Junction to leads (package)	116	°C/W

Reflow Profile

Profile Feature	Pb-Free Assembly
Average Ramp-Up Rate (T_{smax} to T_p)	3 °C/sec. max.
Preheat	
- Temperature Min. (T_{smin})	150 °C
- Temperature Max. (T_{smax})	200 °C
- Time (t_{smin} to t_{smax})	60-180 sec.
Time maintained above:	
- Temperature (T_L)	217 °C
- Time (t_L)	60-150 sec.
Peak/Classification Temperature (T_p)	260 °C
Time within 5 °C of Actual Peak Temp. (t_p)	20-40 sec.
Ramp-Down Rate	6 °C/sec. max.
Time 25 °C to Peak Temperature	8 min. max.

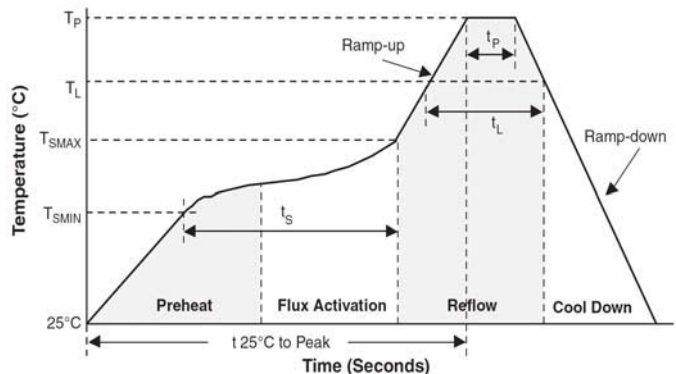

Specifications are subject to change without notice. Customers should verify actual device performance in their specific applications.

C650 and C850 Series TBU® High-Speed Protectors

BOURNS®

How to Order

C 650 - 180 - WH

Form Factor _____
 C = One TBU® protector in the device

Impulse Voltage Rating _____
 650 = 650 V
 850 = 850 V

Top Indicator _____
 100 = 100 mA
 180 = 180 mA
 260 = 260 mA

Typical Part Marking

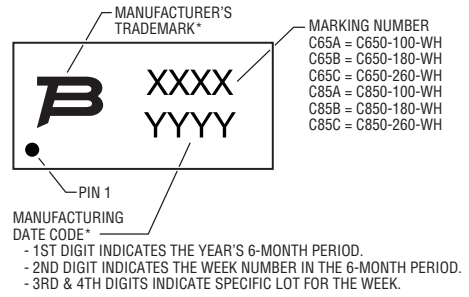

6-MONTH PERIOD CODES:
 A = JAN-JUN 2009 C = JAN-JUN 2010 E = JAN-JUN 2011
 B = JUL-DEC 2009 D = JUL-DEC 2010 F = JUL-DEC 2011

EXAMPLE: ARBC
 - 1ST DIGIT 'A' = JAN-JUN 2009
 - 2ND DIGIT 'R' = WEEK 18; WEEK OF APRIL 27
 - 3RD & 4TH DIGITS 'BC' = LOT SPECIFIC INFORMATION

*TRANSITION FROM FULTEC TRADEMARK AND LOT CODE TO BOURNS TRADEMARK AND DATE CODE IN 2009.

Packaging Specifications (per EIA468-B)

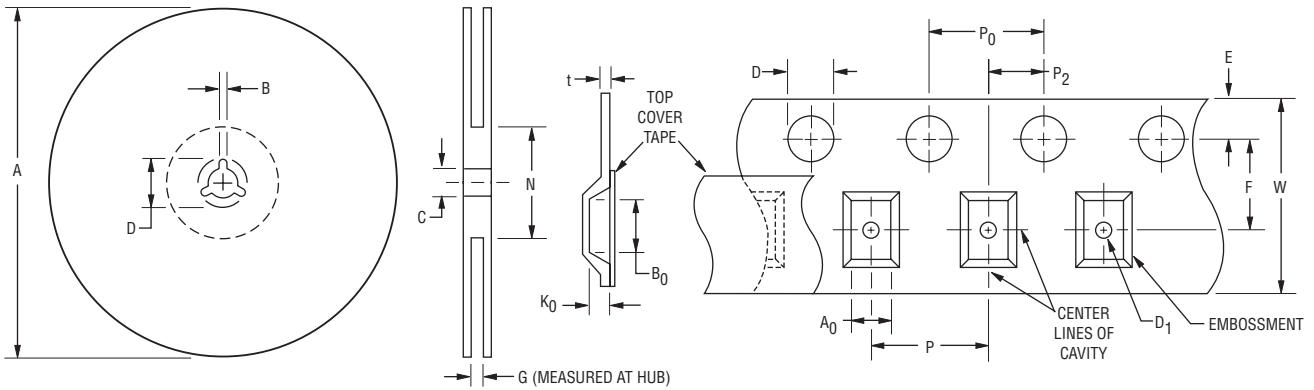

USER DIRECTION OF FEED →

QUANTITY: 3000 PIECES PER REEL

Device	A		B		C		D		G		N	
	Min.	Max.	Min.	Max.	Min.	Max.	Min.	Max.	Ref.	Ref.	Ref.	Ref.
C650, C850	326 (.12.835)	330.25 (.13.002)	1.5 (.059)	2.5 (.098)	12.8 (.504)	13.5 (.531)	20.2 (.795)	-	16.5 (.650)	102 (.4.016)		

Device	A0		B0		D		D1		E		F	
	Min.	Max.	Min.	Max.	Min.	Max.	Min.	Max.	Min.	Max.	Min.	Max.
C650, C850	4.2 (.165)	4.4 (.173)	8.45 (.333)	8.65 (.341)	1.5 (.059)	1.6 (.063)	1.5 (.059)	-	1.65 (.065)	1.85 (.073)	7.4 (.291)	7.6 (.299)

Device	K0		P		P0		P2		t		W	
	Min.	Max.	Min.	Max.	Min.	Max.	Min.	Max.	Min.	Max.	Min.	Max.
C650, C850	1.1 (.043)	1.3 (.051)	7.9 (.311)	8.1 (.319)	3.9 (.159)	4.1 (.161)	1.9 (.075)	2.1 (.083)	0.25 (.010)	0.35 (.014)	15.7 (.618)	16.3 (.642)

DIMENSIONS: $\frac{MM}{(INCHES)}$

Specifications are subject to change without notice.
 Customers should verify actual device performance in their specific applications.

Reference Application

The C-series devices are general protectors that can be used in a variety of applications. The basic operation of the device will be demonstrated using the single line application shown in the figure below. The test circuit was subjected to a 1000 V, 10/700 μ s surge waveform. The devices used were the TBU-C850-100-WH and a 2031-42T-SM-RPLF GDT (OVP) with a 10 ohm resistor for the load impedance.

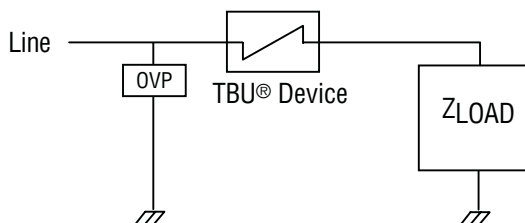

General Application Circuit

The graph below shows the waveforms for the voltage across the overvoltage protector (GDT) and the current through the TBU® device. As the input line voltage increases, the current through the TBU® device increases rapidly until the trip current is reached. Due to finite reaction time for fast transients, the peak level may exceed the low frequency data sheet maximum for a very short period, typically ~ 100 ns. After this initial overshoot, the TBU® device will transition to the protected state, setting the current to the nominal current limiting level (~ 150 mA for this example). The TBU® device will then reduce the current down to its very low quiescent level of 1 mA, typically. As the input line voltage increases to about 500 V, the GDT is triggered, reducing the input line voltage to a very low level which prevents the TBU® device from being subjected to a voltage level which exceeds its maximum rating (850 V in this example). The TBU® High-Speed Protector and the GDT will remain in these states until the surge ends, which is about 700 μ s later in this example. Only the first 4 μ s of the surge are shown in the graph. For surges or AC voltages below the GDT breakover voltage, the GDT will not activate, and the TBU® device will stay in the protecting mode, blocking high voltages from the protected equipment.

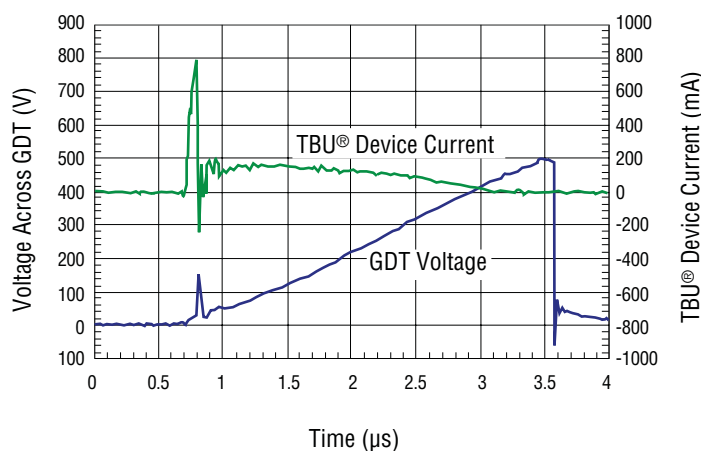

TBU-C850-100-WH Response to a 1000 V, 10/700 μ s Surge

Компания «Life Electronics» занимается поставками электронных компонентов импортного и отечественного производства от производителей и со складов крупных дистрибьюторов Европы, Америки и Азии.

С конца 2013 года компания активно расширяет линейку поставок компонентов по направлению коаксиальный кабель, кварцевые генераторы и конденсаторы (керамические, пленочные, электролитические), за счёт заключения дистрибьюторских договоров

Мы предлагаем:

- Конкурентоспособные цены и скидки постоянным клиентам.
- Специальные условия для постоянных клиентов.
- Подбор аналогов.
- Поставку компонентов в любых объемах, удовлетворяющих вашим потребностям.
- Приемлемые сроки поставки, возможна ускоренная поставка.
- Доставку товара в любую точку России и стран СНГ.
- Комплексную поставку.
- Работу по проектам и поставку образцов.
- Формирование склада под заказчика.
- Сертификаты соответствия на поставляемую продукцию (по желанию клиента).
- Тестирование поставляемой продукции.
- Поставку компонентов, требующих военную и космическую приемку.
- Входной контроль качества.
- Наличие сертификата ISO.

В составе нашей компании организован Конструкторский отдел, призванный помогать разработчикам, и инженерам.

Конструкторский отдел помогает осуществить:

- Регистрацию проекта у производителя компонентов.
- Техническую поддержку проекта.
- Защиту от снятия компонента с производства.
- Оценку стоимости проекта по компонентам.
- Изготовление тестовой платы монтаж и пусконаладочные работы.



Тел: +7 (812) 336 43 04 (многоканальный)

Email: org@lifeelectronics.ru