

LD CN5M

OSLON® SX

The OSLON® SX combine a compact size (small footprint: 3x3mm) with a high efficiency and a electrically insulated thermal pad.

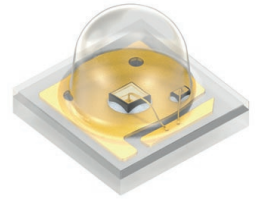

Applications

- Cluster, Button Backlighting
- Custom Tuning
- Electronic Equipment
- Flash & Autofocus
- Head-Up Display LED & Laser
- Industrial Automation (Machine Controls, Light Barriers, Vision Controls)
- Interior Illumination (e.g. Ambient Map)
- Transportation, Plane, Ship

Features:

- Package: SMD ceramic package with silicone lens
- Chip technology: ThinGaN
- Typ. Radiation: 60°
- Color: $\lambda_{\text{dom}} = 453 \text{ nm}$ (• deep blue)
- Corrosion Robustness Class: 3B
- Qualifications: The product qualification test plan is based on the guidelines of AEC-Q101-REV-C, Stress Test Qualification for Automotive Grade Discrete Semiconductors.
- ESD: 2 kV acc. to ANSI/ESDA/JEDEC JS-001 (HBM, Class 2)

Ordering Information

Type	Total radiant flux ¹⁾ $I_F = 140 \text{ mA}$ Φ_E	Ordering Code
LD CN5M-4Q4R-35-1	100 ... 180 mW	Q65110A8683
LD CN5M-1R1S-35-1	112 ... 201 mW	Q65110A9085

Maximum Ratings

Parameter	Symbol		Values
Operating Temperature	T_{op}	min. max.	-40 °C 125 °C
Storage Temperature	T_{stg}	min. max.	-40 °C 125 °C
Forward current $T_s = 25\text{ °C}$	I_F	min. max.	30 mA 250 mA
Surge Current $t \leq 10\text{ }\mu\text{s}$; $D = 0.005$; $T_s = 25\text{ °C}$	I_{FS}	max.	1000 mA
ESD withstand voltage acc. to ANSI/ESDA/JEDEC JS-001 (HBM, Class 2)	V_{ESD}		2 kV
Reverse current ²⁾	I_R	max.	200 mA

Characteristics

$I_F = 140 \text{ mA}$; $T_s = 25 \text{ °C}$

Parameter	Symbol		Values
Peak Wavelength	λ_{peak}	typ.	452 nm
Dominant Wavelength ³⁾ $I_F = 140 \text{ mA}$	λ_{dom}	min. typ. max.	449 nm 453 nm 461 nm
Spectral Bandwidth at 50% $I_{\text{rel,max}}$	$\Delta\lambda$	typ.	25 nm
Viewing angle at 50% I_V	2ϕ	typ.	60 °
Forward Voltage ⁴⁾ $I_F = 140 \text{ mA}$	V_F	min. typ. max.	2.90 V 3.29 V 3.80 V
Reverse voltage (ESD device)	$V_{\text{RES D}}$	min.	45 V
Reverse voltage ²⁾ $I_R = 20 \text{ mA}$	V_R	max.	1.2 V
Real thermal resistance junction/solderpoint ⁵⁾	$R_{\text{thJS real}}$	typ. max.	27 K / W 30 K / W

Brightness Groups

Group	Total radiant flux ¹⁾ $I_F = 140 \text{ mA}$ min. Φ_E	Total radiant flux ¹⁾ $I_F = 140 \text{ mA}$ max. Φ_E
4Q	100 mW	112 mW
1R	112 mW	125 mW
2R	125 mW	140 mW
3R	140 mW	159 mW
4R	159 mW	180 mW
1S	180 mW	201 mW

Forward Voltage Groups

Group	Forward Voltage ⁴⁾ $I_F = 140 \text{ mA}$ min. V_F	Forward Voltage ⁴⁾ $I_F = 140 \text{ mA}$ max. V_F
4	2.90 V	3.20 V
5	3.20 V	3.50 V
6	3.50 V	3.80 V

Wavelength Groups

Group	Dominant Wavelength ³⁾ $I_F = 140 \text{ mA}$ min. λ_{dom}	Dominant Wavelength ³⁾ $I_F = 140 \text{ mA}$ max. λ_{dom}
3	449 nm	453 nm
4	453 nm	457 nm
5	457 nm	461 nm

Group Name on Label

Example: 1R-3-4

Brightness	Wavelength	Forward Voltage
1R	3	4

Relative Spectral Emission ⁶⁾

$I_{rel} = f(\lambda); I_F = 140 \text{ mA}; T_S = 25 \text{ }^\circ\text{C}$

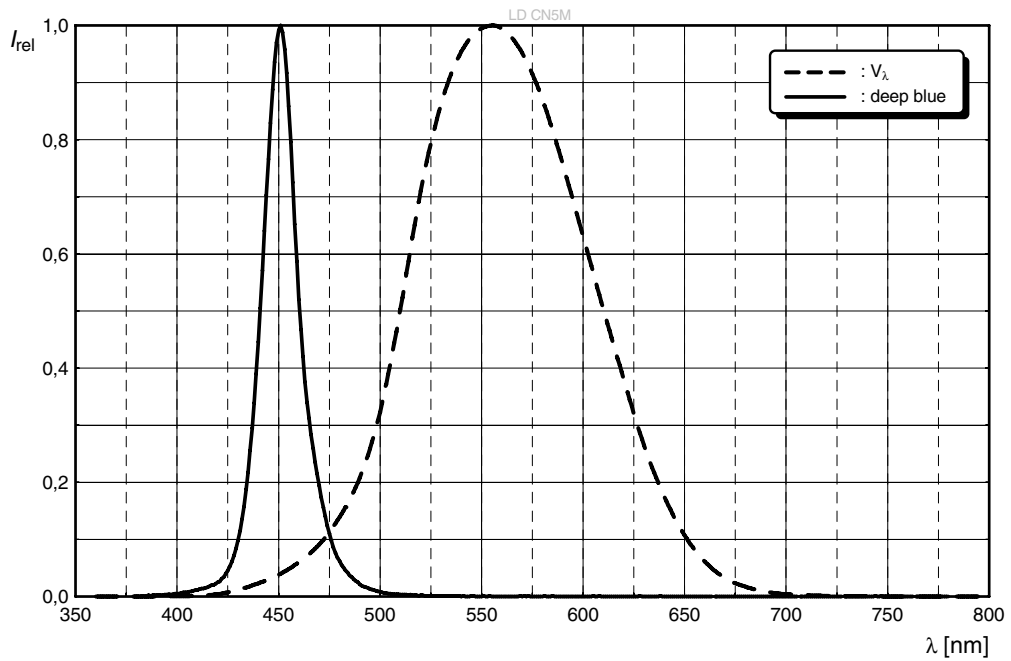

Radiation Characteristics ⁶⁾

$I_{rel} = f(\phi); T_S = 25 \text{ }^\circ\text{C}$

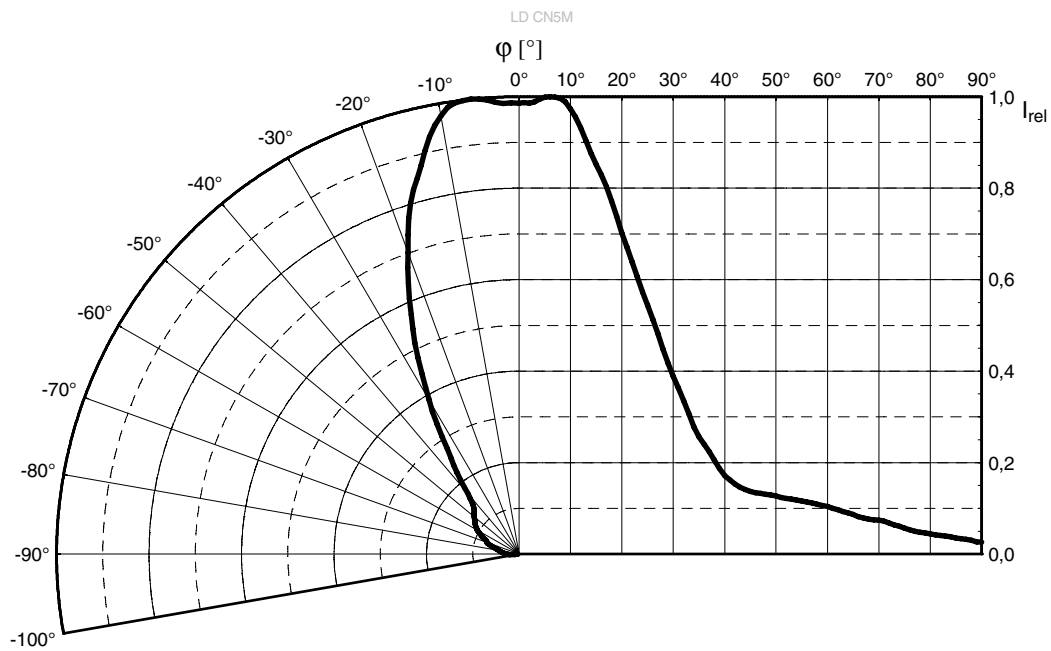

Not for new design

Forward current 6), 7)

$I_F = f(V_F); T_S = 25\text{ °C}$

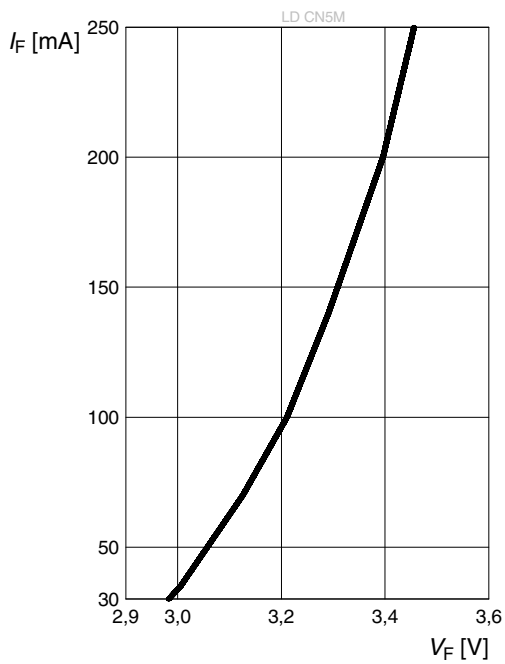

Relative Radiant Power 6), 7)

$\Phi_E / \Phi_E(140\text{ mA}) = f(I_F); T_S = 25\text{ °C}$

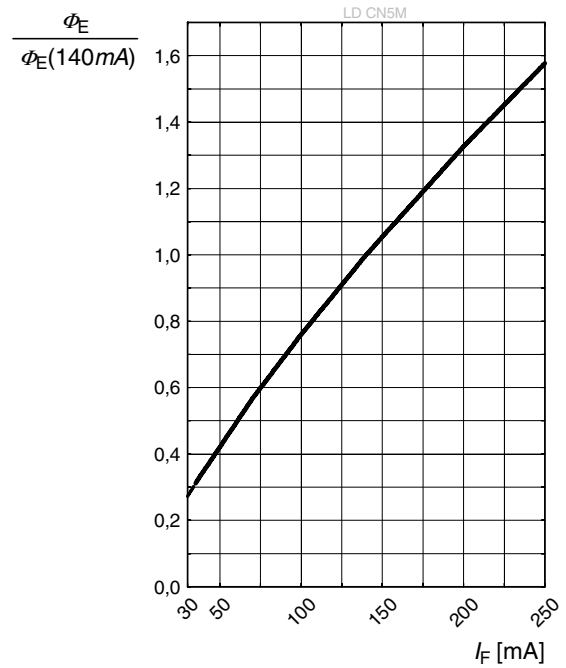

Dominant Wavelength 6)

$\Delta\lambda_{\text{dom}} = f(I_F); T_S = 25\text{ °C}$

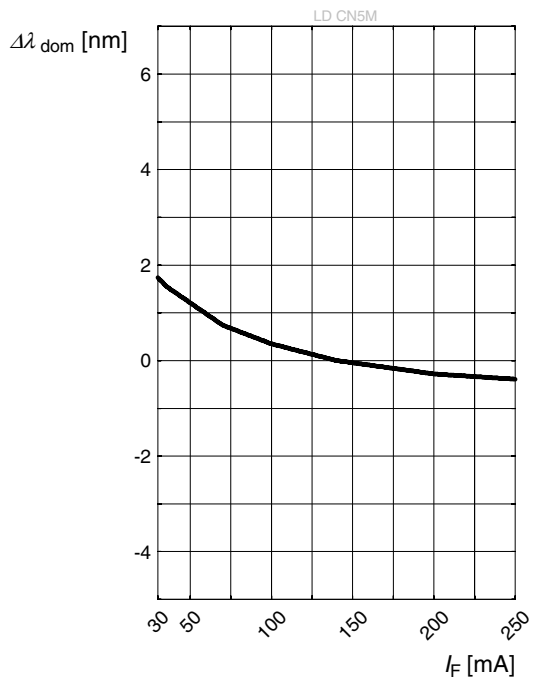

Not for new design

Forward Voltage ⁶⁾

$$\Delta V_F = V_F - V_F(25\text{ °C}) = f(T_j); I_F = 140\text{ mA}$$

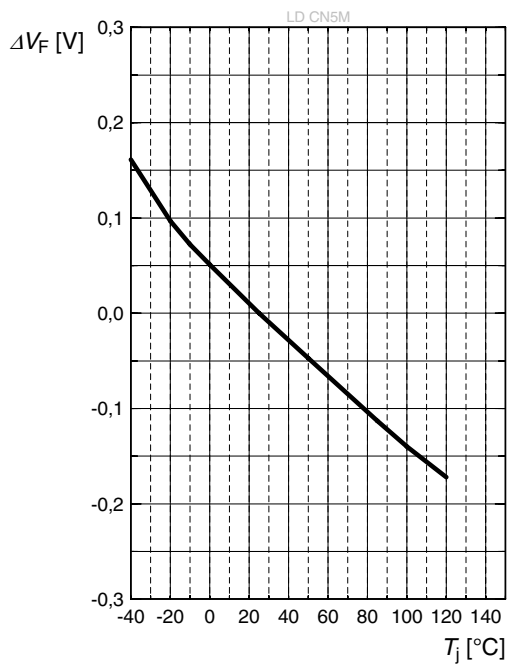
**Relative Radiant Power** ⁶⁾

$$\Phi_E / \Phi_E(25\text{ °C}) = f(T_j); I_F = 140\text{ mA}$$

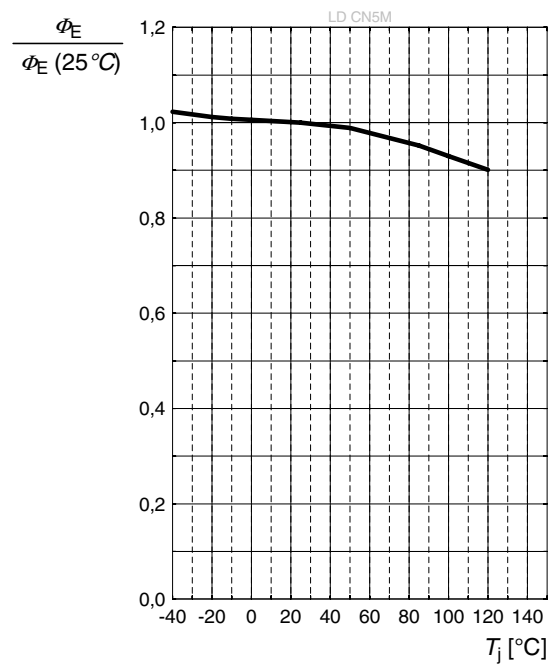
**Dominant Wavelength** ⁶⁾

$$\Delta \lambda_{\text{dom}} = \lambda_{\text{dom}} - \lambda_{\text{dom}}(25\text{ °C}) = f(T_j); I_F = 140\text{ mA}$$

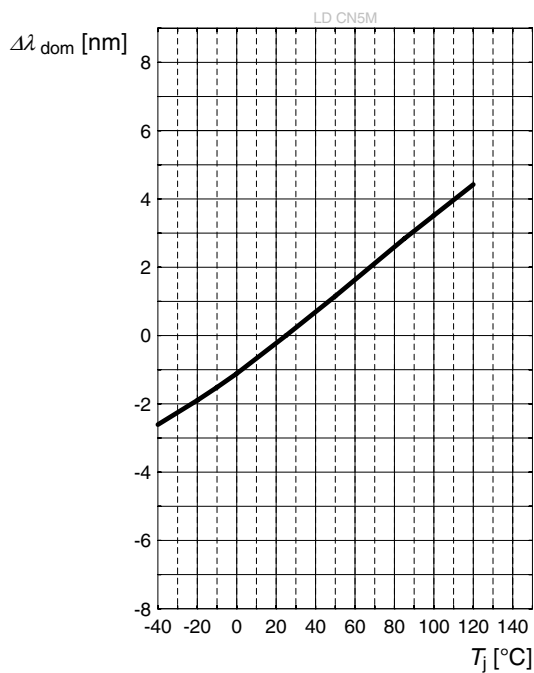

Max. Permissible Forward Current

$$I_F = f(T)$$

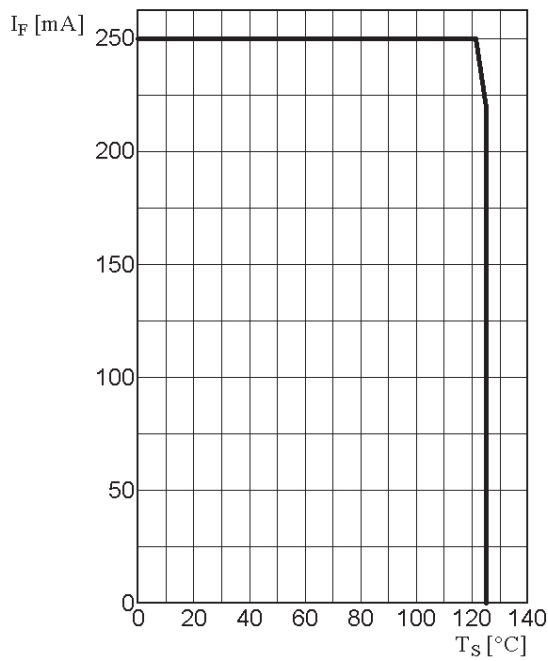

Permissible Pulse Handling Capability

$$I_F = f(t_p); D: \text{Duty cycle}; T_s = 25^\circ\text{C}$$

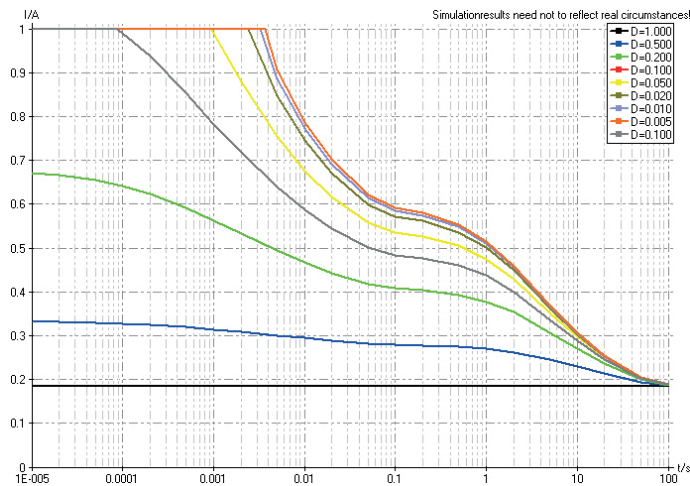

Permissible Pulse Handling Capability

$$I_F = f(t_p); D: \text{Duty cycle}; T_s = 85^\circ\text{C}$$

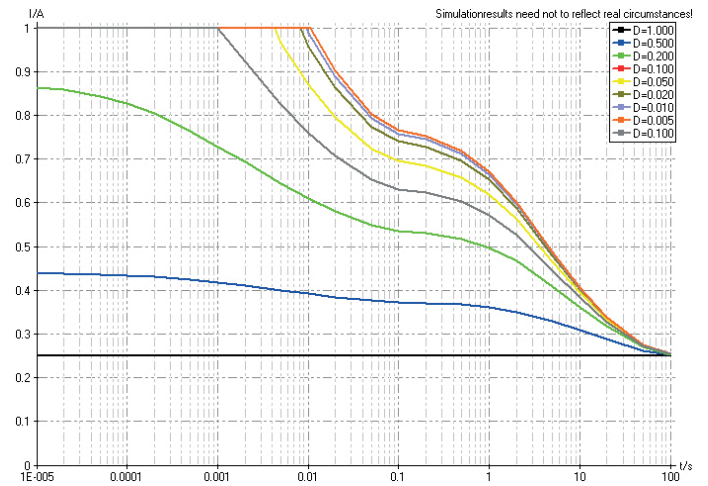

Not for new design

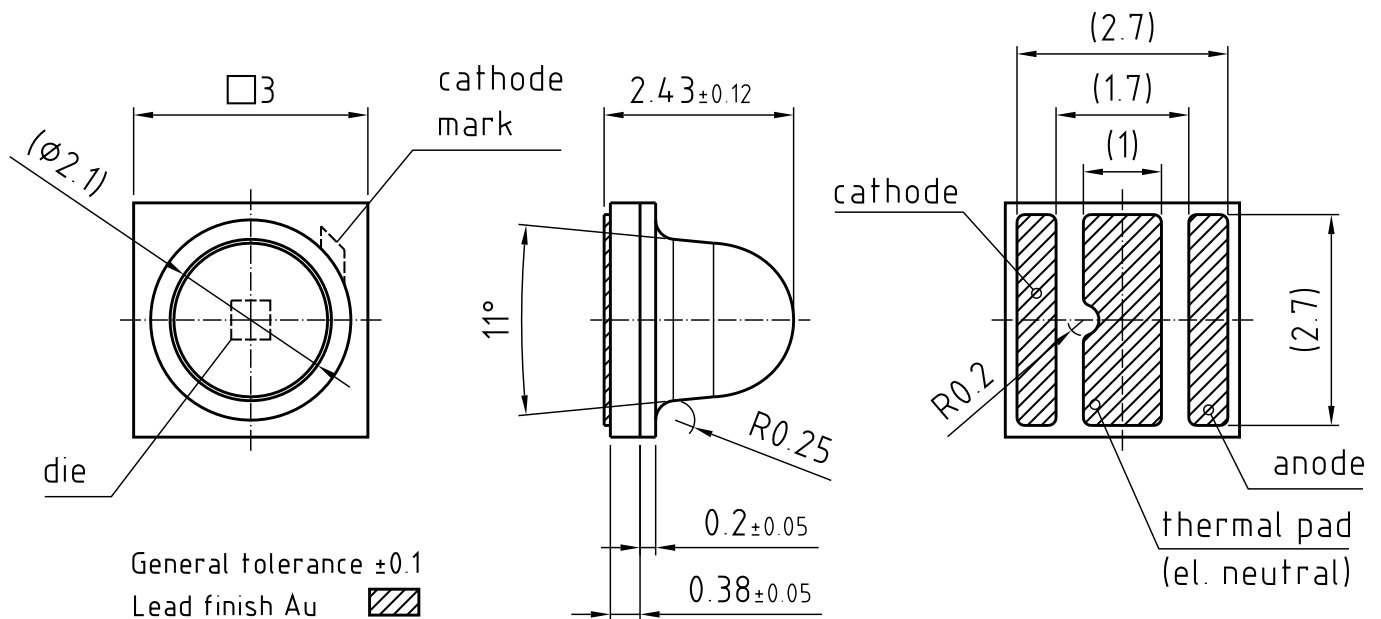
Dimensional Drawing ⁸⁾

C63062-A3991-A1.-12

Further Information:

Approximate Weight: 26.0 mg

Package marking: Cathode

Corrosion test: Class: 3B
Test condition: 40°C / 90 % RH / 15 ppm H_2S / 14 days (stricter than IEC 60068-2-43)

ESD advice: The device is protected by ESD device which is connected in parallel to the Chip.

Electrical Internal Circuit

ESD protection device

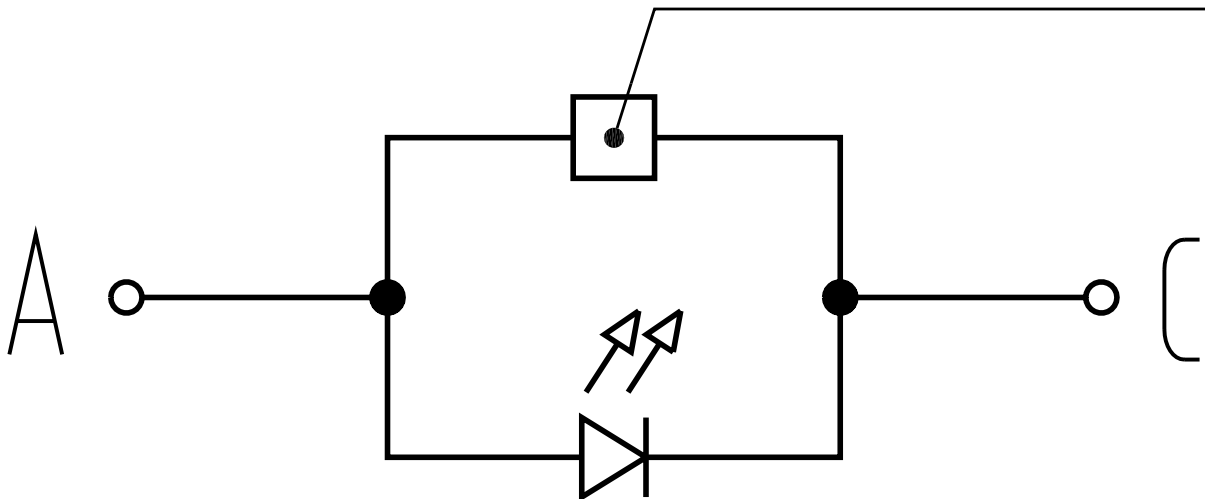

Recommended Solder Pad ⁸⁾

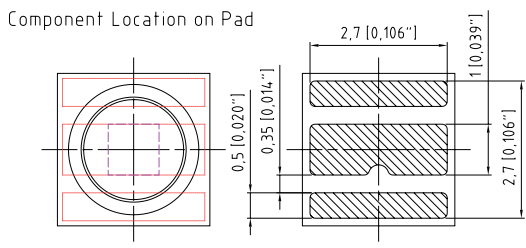
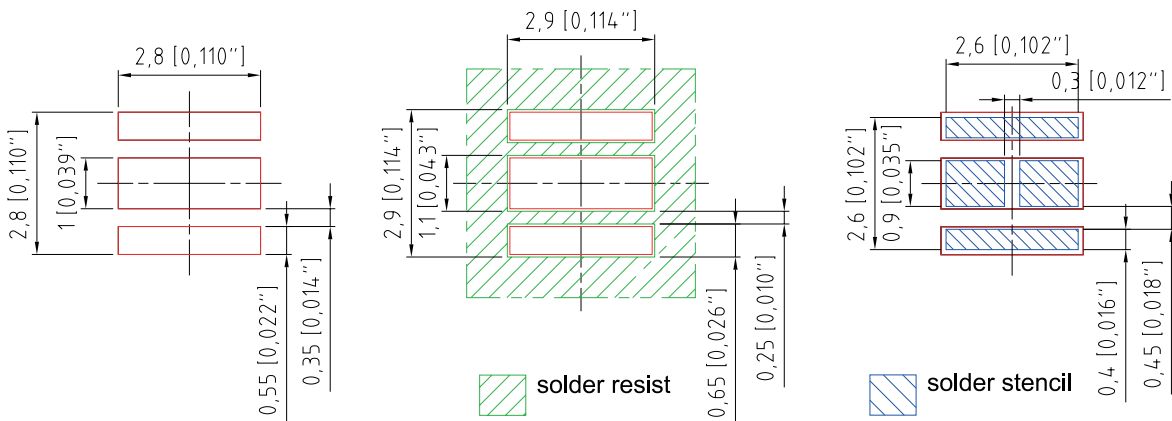

E062.3010.73 -04

For superior solder joint connectivity results we recommend soldering under standard nitrogen atmosphere. Package not suitable for ultra sonic cleaning.

Not for new design

Reflow Soldering Profile

Product complies to MSL Level 2 acc. to JEDEC J-STD-020E

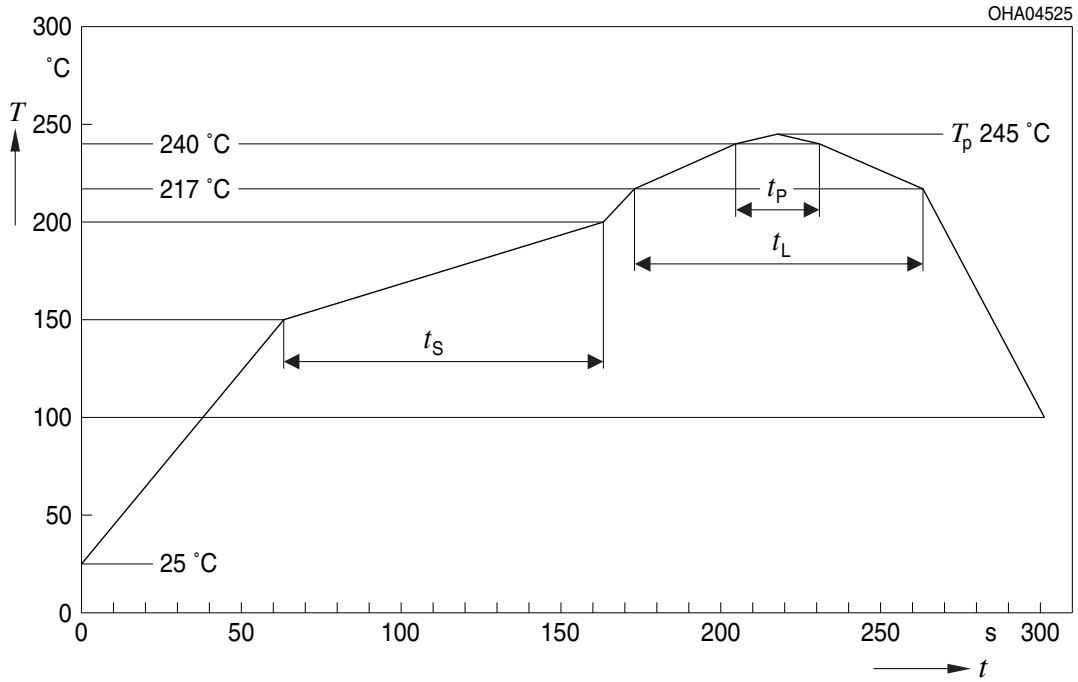

Profile Feature	Symbol	Pb-Free (SnAgCu) Assembly			Unit
		Minimum	Recommendation	Maximum	
Ramp-up rate to preheat ^{*)} 25 °C to 150 °C			2	3	K/s
Time t_s T_{Smin} to T_{Smax}	t_s	60	100	120	s
Ramp-up rate to peak ^{*)} T_{Smax} to T_p			2	3	K/s
Liquidus temperature	T_L		217		°C
Time above liquidus temperature	t_L		80	100	s
Peak temperature	T_p		245	260	°C
Time within 5 °C of the specified peak temperature $T_p - 5$ K	t_p	10	20	30	s
Ramp-down rate* T_p to 100 °C			3	6	K/s
Time 25 °C to T_p				480	s

All temperatures refer to the center of the package, measured on the top of the component
 *) slope calculation DT/Dt : Dt max. 5 s; fulfillment for the whole T-range

Not for new design

Taping ⁸⁾

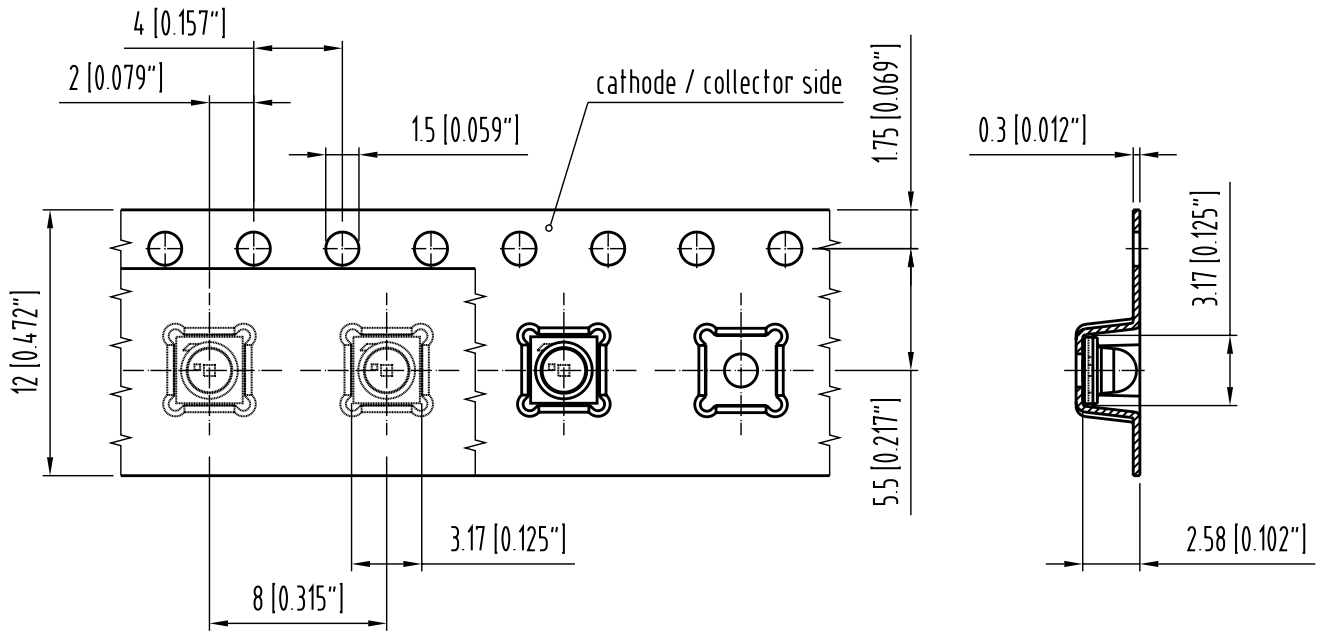

C63062-A3991-B9-07

Tape and Reel ⁹⁾



Reel Dimensions

A	W	N _{min}	W ₁	W _{2max}	Pieces per PU
180 mm	12 + 0.3 / - 0.1 mm	60 mm	12.4 + 2 mm	18.4 mm	600

Not for new design

Barcode-Product-Label (BPL)

OSRAM Opto Semiconductors LX XXXX BIN1: XX-XX-X-XXX-X

RoHS Compliant

(6P) BATCH NO: 1234567890 ML Temp ST
X XXX °C X

(1T) LOT NO: 1234567890 (9D) D/C: 1234 Pack: RXX
DEMY XXX
X_X123_1234.1234 X

(X) PROD NO: 123456789(Q)QTY: 9999 (G) GROUP: XX-XX-X-X

The diagram shows a rectangular label with rounded corners. It contains the OSRAM logo and product name at the top left. To the right are fields for 'LX XXXX' and 'BIN1: XX-XX-X-XXX-X'. Below the logo is 'RoHS Compliant'. The main body of the label is divided into three horizontal sections, each with a barcode and associated text: (6P) BATCH NO: 1234567890, (1T) LOT NO: 1234567890, and (X) PROD NO: 123456789(Q)QTY: 9999. To the right of the lot number is '(9D) D/C: 1234'. To the right of the product number is '(G) GROUP: XX-XX-X-X'. A 'Moisture-sensitive label or print' icon (a circle with a diagonal line and three drops) is positioned above the lot number. To the right of this icon is 'ML Temp ST X XXX °C X'. Below the lot number is 'Pack: RXX', 'DEMY XXX', and 'X_X123_1234.1234 X'. A square QR code is located on the right side of the label.

OHA04563

Dry Packing Process and Materials ⁸⁾



OHA00539

Moisture-sensitive product is packed in a dry bag containing desiccant and a humidity card according JEDEC-STD-033.

Not for new design

Type Designation System

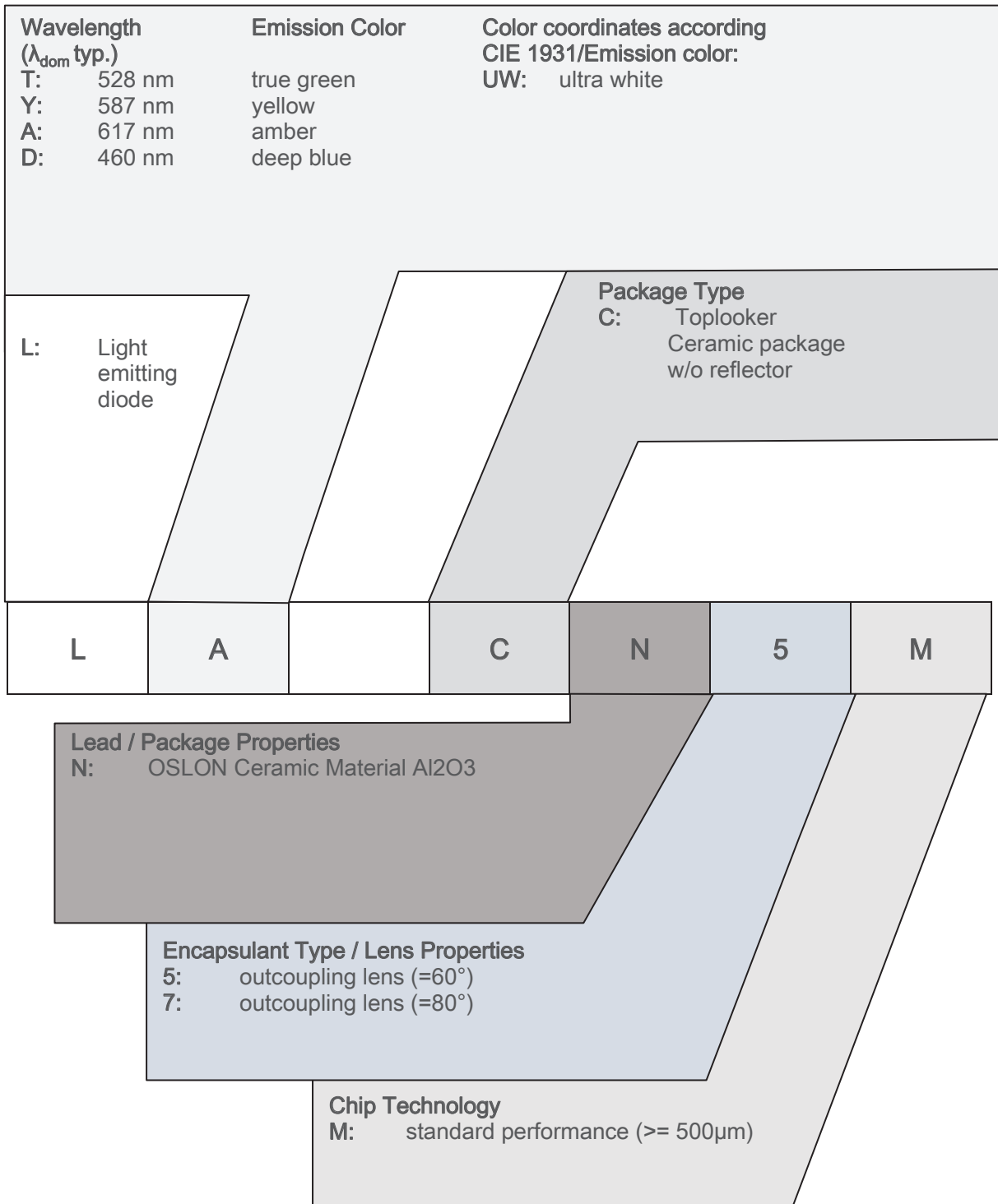

Not for new design

Notes

The evaluation of eye safety occurs according to the standard IEC 62471:2006 (photo biological safety of lamps and lamp systems). Within the risk grouping system of this IEC standard, the device specified in this data sheet falls into the class **moderate risk (exposure time 0.25 s)**. Under real circumstances (for exposure time, conditions of the eye pupils, observation distance), it is assumed that no endangerment to the eye exists from these devices. As a matter of principle, however, it should be mentioned that intense light sources have a high secondary exposure potential due to their blinding effect. When looking at bright light sources (e.g. headlights), temporary reduction in visual acuity and afterimages can occur, leading to irritation, annoyance, visual impairment, and even accidents, depending on the situation.

Subcomponents of this device contain, in addition to other substances, metal filled materials including silver. Metal filled materials can be affected by environments that contain traces of aggressive substances. Therefore, we recommend that customers minimize device exposure to aggressive substances during storage, production, and use. Devices that showed visible discoloration when tested using the described tests above did show no performance deviations within failure limits during the stated test duration. Respective failure limits are described in the IEC60810.

For further application related information please visit www.osram-os.com/appnotes

Disclaimer

Attention please!

The information describes the type of component and shall not be considered as assured characteristics. Terms of delivery and rights to change design reserved. Due to technical requirements components may contain dangerous substances.

For information on the types in question please contact our Sales Organization.

If printed or downloaded, please find the latest version on the OSRAM OS website.

Packing

Please use the recycling operators known to you. We can also help you – get in touch with your nearest sales office. By agreement we will take packing material back, if it is sorted. You must bear the costs of transport. For packing material that is returned to us unsorted or which we are not obliged to accept, we shall have to invoice you for any costs incurred.

Product and functional safety devices/applications or medical devices/applications

OSRAM OS components are not developed, constructed or tested for the application as safety relevant component or for the application in medical devices.

OSRAM OS products are not qualified at module and system level for such application.

In case buyer – or customer supplied by buyer – considers using OSRAM OS components in product safety devices/applications or medical devices/applications, buyer and/or customer has to inform the local sales partner of OSRAM OS immediately and OSRAM OS and buyer and /or customer will analyze and coordinate the customer-specific request between OSRAM OS and buyer and/or customer.

Glossary

- 1) **Brightness:** Brightness values are measured during a current pulse of typically 25 ms, with an internal reproducibility of $\pm 8\%$ and an expanded uncertainty of $\pm 11\%$ (acc. to GUM with a coverage factor of $k = 3$).
- 2) **Reverse Operation:** Reverse Operation of 10 hours is permissible in total. Continuous reverse operation is not allowed.
- 3) **Wavelength:** The wavelength is measured at a current pulse of typically 25 ms, with an internal reproducibility of ± 0.5 nm and an expanded uncertainty of ± 1 nm (acc. to GUM with a coverage factor of $k = 3$).
- 4) **Forward Voltage:** The forward voltage is measured during a current pulse of typically 8 ms, with an internal reproducibility of ± 0.05 V and an expanded uncertainty of ± 0.1 V (acc. to GUM with a coverage factor of $k = 3$).
- 5) **Thermal Resistance:** $R_{th\ max}$ is based on statistic values (6σ).
- 6) **Typical Values:** Due to the special conditions of the manufacturing processes of semiconductor devices, the typical data or calculated correlations of technical parameters can only reflect statistical figures. These do not necessarily correspond to the actual parameters of each single product, which could differ from the typical data and calculated correlations or the typical characteristic line. If requested, e.g. because of technical improvements, these typ. data will be changed without any further notice.
- 7) **Characteristic curve:** In the range where the line of the graph is broken, you must expect higher differences between single devices within one packing unit.
- 8) **Tolerance of Measure:** Unless otherwise noted in drawing, tolerances are specified with ± 0.1 and dimensions are specified in mm.
- 9) **Tape and Reel:** All dimensions and tolerances are specified acc. IEC 60286-3 and specified in mm.

Revision History

Version	Date	Change
1.6	2019-07-19	Features Further Information
1.7	2020-03-23	Schematic Transportation Box Dimensions of Transportation Box

Published by OSRAM Opto Semiconductors GmbH EU RoHS and China RoHS compliant product
Leibnizstraße 4, D-93055 Regensburg
www.osram-os.com © All Rights Reserved.



此产品符合欧盟 RoHS 指令的要求；
按照中国的相关法规和标准，不含有毒有害物质或元素。

Компания «Life Electronics» занимается поставками электронных компонентов импортного и отечественного производства от производителей и со складов крупных дистрибьюторов Европы, Америки и Азии.

С конца 2013 года компания активно расширяет линейку поставок компонентов по направлению коаксиальный кабель, кварцевые генераторы и конденсаторы (керамические, пленочные, электролитические), за счёт заключения дистрибьюторских договоров

Мы предлагаем:

- Конкурентоспособные цены и скидки постоянным клиентам.
- Специальные условия для постоянных клиентов.
- Подбор аналогов.
- Поставку компонентов в любых объемах, удовлетворяющих вашим потребностям.
- Приемлемые сроки поставки, возможна ускоренная поставка.
- Доставку товара в любую точку России и стран СНГ.
- Комплексную поставку.
- Работу по проектам и поставку образцов.
- Формирование склада под заказчика.
- Сертификаты соответствия на поставляемую продукцию (по желанию клиента).
- Тестирование поставляемой продукции.
- Поставку компонентов, требующих военную и космическую приемку.
- Входной контроль качества.
- Наличие сертификата ISO.

В составе нашей компании организован Конструкторский отдел, призванный помогать разработчикам, и инженерам.

Конструкторский отдел помогает осуществить:

- Регистрацию проекта у производителя компонентов.
- Техническую поддержку проекта.
- Защиту от снятия компонента с производства.
- Оценку стоимости проекта по компонентам.
- Изготовление тестовой платы монтаж и пусконаладочные работы.



Тел: +7 (812) 336 43 04 (многоканальный)
Email: org@lifeelectronics.ru