

Reference Only

Spec.No.JENF243A-0096-01

P1/8

GHz Noise Suppression Chip Ferrite Bead

BLM18DN□□□SN1□ Reference Specification

1. Scope

This reference specification applies to Chip Ferrite Bead BLM18DN_SN series.

2. Part Numbering

(ex.) $\frac{BL}{(1)} \frac{M}{(2)} \frac{18}{(3)} \frac{DN}{(4)} \frac{601}{(5)} \frac{S}{(6)} \frac{N}{(7)} \frac{1}{(8)} \frac{D}{(9)}$

(1)Product ID (2)Type (3)Dimension(LxW) (4)Characteristics (5)Typical Impedance at 100MHz
(6)Performance (7)Category (8)Numbers of Circuit (9)Packaging(D:Taping / B:Bulk)

3. Rating

Customer Part Number	MURATA Part Number	Impedance (Ω) (Under Standard Testing Condition)		Rated Current (mA)		DC Resistance (Ω max.)	
		at 100MHz	at 1GHz	at 85°C	at 125°C	Initial Values	Values After Testing
	BLM18DN151SN1D BLM18DN151SN1B	150±25%	400±30%	1400	900	0.120	0.140
	BLM18DN221SN1D BLM18DN221SN1B	220±25%	650±30%	1000	650	0.210	0.255
	BLM18DN381SN1D BLM18DN381SN1B	380±25%	1100±30%	850	550	0.325	0.390
	BLM18DN601SN1D BLM18DN601SN1B	600±25%	1500±30%	700	450	0.435	0.525

- Operating Temperature : -55°C to +125°C
- Storage Temperature : -55°C to +125°C

(Notes)
Rated Current is derated as right figure depending on the operating temperature.

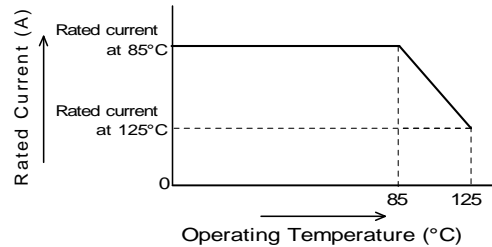

4. Style and Dimensions

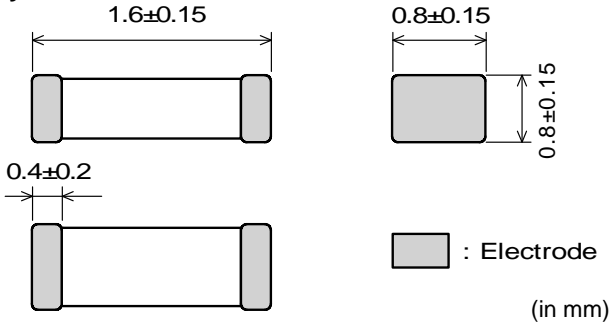

Equivalent Circuit

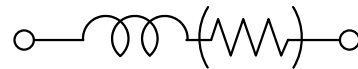

(Resistance element becomes dominant at high frequencies.)

- Unit Mass (Typical value)
0.004g

5. Marking

No marking.

6. Standard Testing Conditions

< Unless otherwise specified >
 Temperature : Ordinary Temp. (15 °C to 35 °C)
 Humidity : Ordinary Humidity (25%(RH) to 85%(RH))

< In case of doubt >
 Temperature : 20°C±2 °C
 Humidity : 60%(RH) to 70%(RH)
 Atmospheric pressure : 86kPa to 106kPa

Reference Only

Spec.No.JENF243A-0096-01

P2/8

7. Specifications

7-1. Electrical Performance

No.	Item	Specification	Test Method
7-1-1	Impedance	Meet item 3.	Measuring Frequency : 100MHz±1MHz , 1GHz±1MHz Measuring Equipment : KEYSIGHT 4291A or the equivalent Test Fixture : KEYSIGHT 16192A or the equivalent
7-1-2	DC Resistance	Meet item 3.	Measuring Equipment : Digital multi meter *Except resistance of the Substrate and Wire

7-2. Mechanical Performance

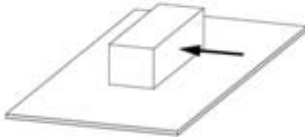
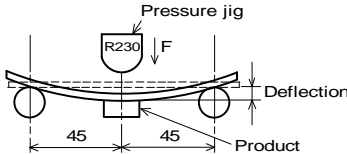
No.	Item	Specification	Test Method						
7-2-1	Bonding Strength	Products shall not be damaged after tested as test method.	It shall be soldered on the substrate. Applying Force(F) : 10N Applying Time : 5s 						
7-2-2	Bending Strength		It shall be soldered on the Glass-epoxy substrate. Substrate: Glass-epoxy 100mm×40mm×1.6mm Deflection : 2mm Speed of Applying Force : 1.0mm/s Keeping Time : 20s Pressure Jig : R230 						
7-2-3	Vibration	Appearance: No damage	It shall be soldered on the substrate. Oscillation Frequency : 10Hz to 2000Hz to 10Hz for 20min Total amplitude 3.0mm or Acceleration amplitude 196 m / s ² whichever is smaller. Testing Time : A period of 2h in each of 3 mutually perpendicular directions.(Total 6h)						
7-2-4	Resistance to Soldering Heat	Meet Table 1. <table border="1" style="margin-left: 20px;"> <caption>Table 1</caption> <tbody> <tr> <td>Appearance</td> <td>No damage</td> </tr> <tr> <td>Impedance Change (at 100MHz)</td> <td>Within ±50%</td> </tr> <tr> <td>DC Resistance</td> <td>Meet item 3.</td> </tr> </tbody> </table>	Appearance	No damage	Impedance Change (at 100MHz)	Within ±50%	DC Resistance	Meet item 3.	Flux : Ethanol solution of rosin,25(wt)% Pre-Heating : 150°C, 60s Solder : Sn-3.0Ag-0.5Cu Solder Temperature : 260°C±5°C Immersion Time : 10s Then measured after exposure in the room condition for 48h±4h.
Appearance	No damage								
Impedance Change (at 100MHz)	Within ±50%								
DC Resistance	Meet item 3.								
7-2-5	Solderability	The electrodes shall be at least 95% covered with new solder coating.	Flux : Ethanol solution of rosin,25(wt)% Pre-Heating : 150°C, 60s Solder : Sn-3.0Ag-0.5Cu Solder Temperature : 245°C±3°C Immersion Time : 3s						

Reference Only

Spec.No.JENF243A-0096-01

P3/8

7-3. Environmental Performance

It shall be soldered on the substrate.

No.	Item	Specification	Test Method						
7-3-1	Heat Life	Meet Table 1.	Temperature : 125°C±2°C Applying Current : Rated Current(at 125°C) Time : 1000h(+48h,-0h) Then measured after exposure in the room condition for 48h±4h.						
7-3-2	Cold Resistance		Temperature : -55±2°C Time : 1000h(+48h,-0h) Then measured after exposure in the room condition for 48h±4h.						
7-3-3	Humidity		Temperature : 40°C±2°C Humidity : 90%(RH) to 95%(RH) Time : 1000h(+48h,-0h) Then measured after exposure in the room condition for 48h±4h.						
7-3-4	Temperature Cycle	Meet Table 2. <table border="1" style="margin-left: 20px;"> <caption>Table 2</caption> <tr> <td>Appearance</td> <td>No damage</td> </tr> <tr> <td>Impedance Change (at 100MHz)</td> <td>Within ±30%</td> </tr> <tr> <td>DC Resistance</td> <td>Meet item 3.</td> </tr> </table>	Appearance	No damage	Impedance Change (at 100MHz)	Within ±30%	DC Resistance	Meet item 3.	1 cycle: 1 step:-55 °C(+0 °C,-3 °C) / 30min±3min 2 step:Ordinary temp. / within 3min 3 step:+125 °C(+3 °C,-0 °C) / 30min±3min 4 step: Ordinary temp. / within 3min Total of 100 cycles Then measured after exposure in the room condition for 48h±4h.
Appearance	No damage								
Impedance Change (at 100MHz)	Within ±30%								
DC Resistance	Meet item 3.								

8. Specification of Packaging

8-1. Appearance and Dimensions (8mm-wide paper tape)

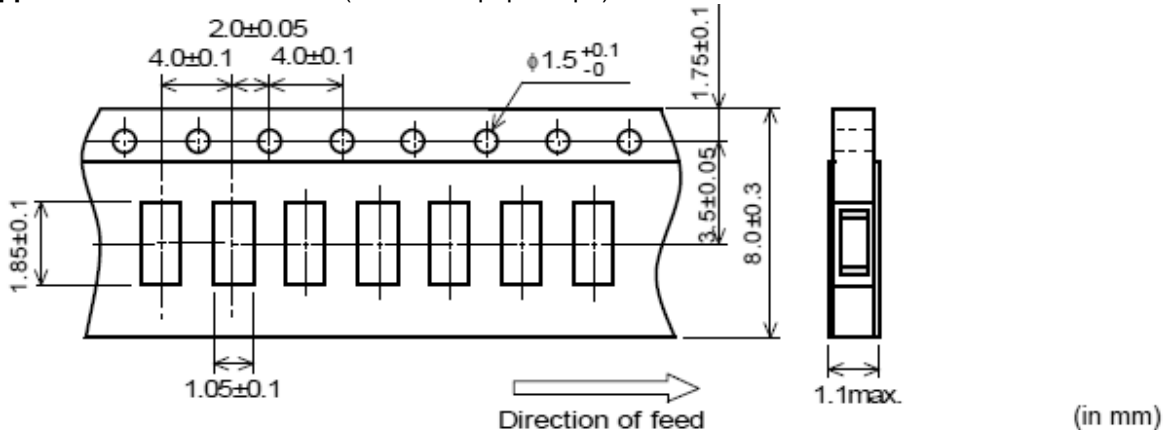

- (1) Taping
Products shall be packaged in the cavity of the base tape of 8mm-wide,4mm-pitch continuously and sealed by top tape and bottom tape.
- (2) Sprocket hole
The sprocket holes are to the right as the tape is pulled toward the user.
- (3) Spliced point
The base tape and top tape have no spliced point
- (4) Cavity
There shall not be burr in the cavity.
- (5) Missing components number
Missing components number within 0.1% of the number per reel or 1 pc., whichever is greater, and are not continuous. The specified quantity per reel is kept.

8-2. Tape Strength

(1) Pull Strength

Top tape	5N min.
Bottom tape	

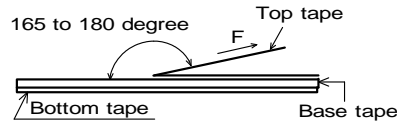

(2) Peeling off force of Top tape

0.1N to 0.6N (Minimum value is typical.)

*Speed of Peeling off:300mm/min

8-3. Taping Condition

(1) Standard quantity per reel

Quantity per 180mm reel: 4000 pcs. / reel

(2) There shall be leader-tape (top tape and empty tape) and trailer- tape(empty tape) as follows.

(3) On paper tape, the top tape and the base tape shall not be adhered at the tip of the empty leader tape for more than 5 pitch.

(4) Marking for reel

The following items shall be marked on a label and the label is stuck on the reel.

(Customer part number, MURATA part number, Inspection number(*1), RoHS marking (*2), Quantity, etc)

*1) « Expression of Inspection No. » $\frac{\square\square}{(1)}$ $\frac{0000}{(2)}$ $\frac{\times\times\times}{(3)}$

(1) Factory Code

(2) Date

First digit : Year / Last digit of year

Second digit : Month / Jan. to Sep. → 1 to 9, Oct. to Dec. → O,N,D

Third, Fourth digit : Day

(3) Serial No.

*2) « Expression of RoHS marking » ROHS - $\frac{Y(\Delta)}{(1)(2)}$

(1) RoHS regulation conformity parts.

(2) MURATA classification number

(5) Outside package

These reels shall be packed in the corrugated cardboard package and the following items shall be marked on a label and the label is stuck on the box.

(Customer name, Purchasing Order Number, Customer Part Number, MURATA part number, RoHS marking (*2) , Quantity , etc)

(6) Dimensions of reel and taping(leader-tape, trailer-tape)

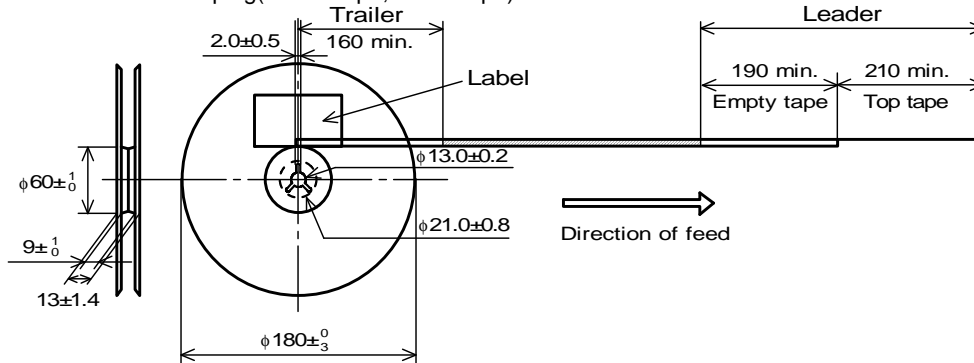

(in mm)

8-4. Specification of Outer Case

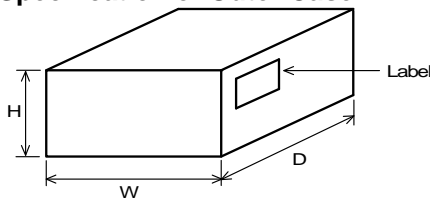

Outer Case Dimensions (mm)			Standard Reel Quantity in Outer Case (Reel)
W	D	H	
186	186	93	5

* Above Outer Case size is typical. It depends on a quantity of an order.

9. ⚠ Caution

9-1. Surge current

Excessive surge current (pulse current or rush current) than specified rated current applied to the product may cause a critical failure, such as an open circuit, burnout caused by excessive temperature rise.
Please contact us in advance in case of applying the surge current.

9-2. Limitation of Applications

Please contact us before using our products for the applications listed below which require especially high reliability for the prevention of defects which might directly cause damage to the third party's life, body or property.

- | | |
|-----------------------------------|--|
| (1) Aircraft equipment | (6) Disaster prevention / crime prevention equipment |
| (2) Aerospace equipment | (7) Traffic signal equipment |
| (3) Undersea equipment | (8) Transportation equipment (vehicles, trains, ships, etc.) |
| (4) Power plant control equipment | (9) Data-processing equipment |
| (5) Medical equipment | (10) Applications of similar complexity and /or reliability requirements to the applications listed in the above |

10. Notice

This product is designed for solder mounting. (reflow soldering only)
Please consult us in advance for applying other mounting method such as conductive adhesive.

10-1. Land pattern designing

- Standard land dimensions (Reflow soldering)

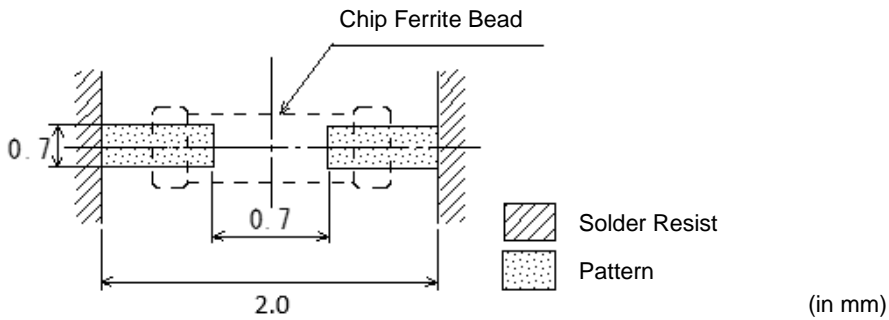

10-2. Soldering Conditions

Products can be applied to reflow soldering.

(1) Flux,Solder

Flux	Use rosin-based flux, but not highly acidic flux (with chlorine content exceeding 0.2(wt)%.) Do not use water-soluble flux.
Solder	Use Sn-3.0Ag-0.5Cu solder Standard thickness of solder paste : 100 μm to 200 μm

(2) Soldering conditions

- Pre-heating should be in such a way that the temperature difference between solder and ferrite surface is limited to 150°C max. Also cooling into solvent after soldering should be in such a way that the temperature difference is limited to 100°C max.
Insufficient pre-heating may cause cracks on the ferrite, resulting in the deterioration of product quality.
- Standard soldering profile and the limit soldering profile is as follows.
The excessive limit soldering conditions may cause leaching of the electrode and / or resulting in the deterioration of product quality.

(3) Soldering profile

Reflow soldering profile

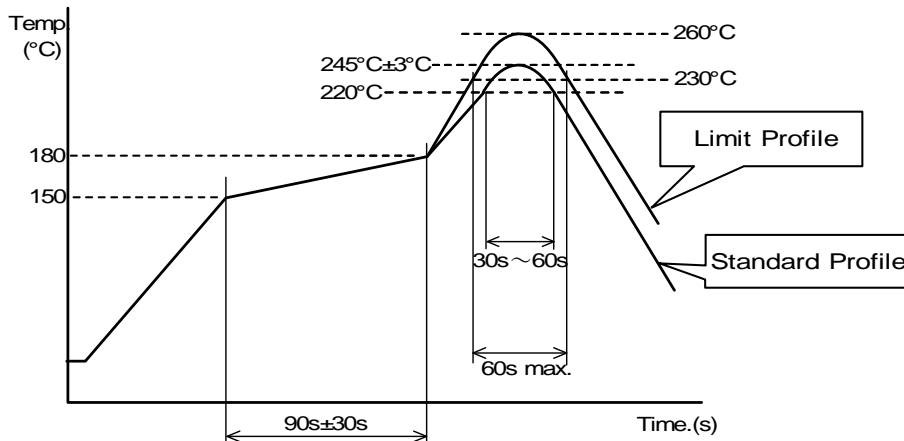

	Standard Profile	Limit Profile
Pre-heating	150~180°C, 90s±30s	
Heating	above 220°C, 30s~60s	above 230°C, 60s max.
Peak temperature	245±3°C	260°C, 10s
Cycle of reflow	2 times	2 times

10-3. Reworking with soldering iron

- Pre-heating : 150°C, 1 min
- Tip temperature : 350°C max.
- Soldering time : 3(+1,-0) seconds.
- Soldering iron output : 80W max.
- Tip diameter : φ 3mm max.
- Times : 2times max.

Note : Do not directly touch the products with the tip of the soldering iron in order to prevent the crack on the ferrite material due to the thermal shock.

10-4. Solder Volume

Solder shall be used not to be exceeded as shown below.

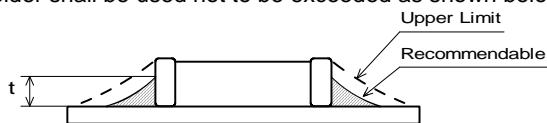

$$\frac{1}{3}t \leq t \leq T$$

(T:Chip thickness)

Accordingly increasing the solder volume, the mechanical stress to product is also increased. Exceeding solder volume may cause the failure of mechanical or electrical performance.

10-5. Attention regarding P.C.B. bending

The following shall be considered when designing and laying out P.C.B.'s.

(1) P.C.B. shall be designed so that products are not subject to the mechanical stress for board warpage.

<Products direction>

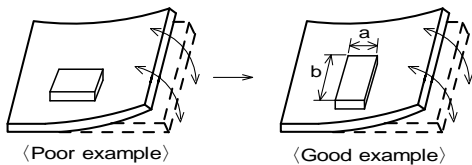

Products shall be located in the sideways direction (Length: $a < b$) to the mechanical stress.

(2) Components location on P.C.B. separation.

It is effective to implement the following measures, to reduce stress in separating the board.

It is best to implement all of the following three measures; however, implement as many measures as possible to reduce stress.

Contents of Measures	Stress Level
(1) Turn the mounting direction of the component parallel to the board separation surface.	$A > D$ *1
(2) Add slits in the board separation part.	$A > B$
(3) Keep the mounting position of the component away from the board separation surface.	$A > C$

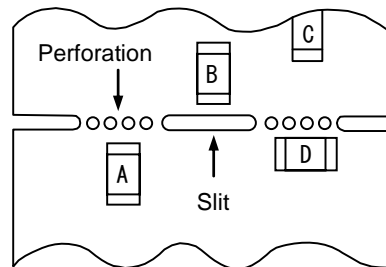

*1 $A > D$ is valid when stress is added vertically to the perforation as with Hand Separation. If a Cutting Disc is used, stress will be diagonal to the PCB, therefore $A > D$ is invalid.

(3) Mounting Components Near Screw Holes

When a component is mounted near a screw hole, it may be affected by the board deflection that occurs during the tightening of the screw. Mount the component in a position as far away from the screw holes as possible.

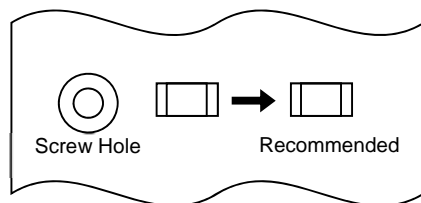

10-6. Mounting density

Add special attention to radiating heat of products when mounting the inductor near the products with heating. The excessive heat by other products may cause deterioration at joint of this product with substrate.

10-7. Operating Environment

Do not use this product under the following environmental conditions, on deterioration of the Insulation Resistance of the Ferrite material and/or corrosion of Inner Electrode may result from the use.

- (1) in the corrodible atmosphere such as acidic gases, alkaline gases, chlorine, sulfur gases, organic gases and etc. (the sea breeze, Cl_2 , H_2S , NH_3 , SO_2 , NO_2 , etc)
- (2) in the atmosphere where liquid such as organic solvent, may splash on the products.
- (3) in the atmosphere where the temperature / humidity changes rapidly and it is easy to dew.

10-8. Resin coating

The impedance value may change and/or it may affect on the product's performance due to high cure-stress of resin to be used for coating / molding products. So please pay your careful attention when you select resin. In prior to use, please make the reliability evaluation with the product mounted in your application set.

10-9. Cleaning Conditions

Products shall be cleaned on the following conditions.

- (1) Cleaning temperature shall be limited to 60°C max. (40°C max. for IPA.)
- (2) Ultrasonic cleaning shall comply with the following conditions, avoiding the resonance phenomenon at the mounted products and P.C.B.
Power:20W/l max. Frequency:28kHz to 40kHz Time:5 min max.
- (3) Cleaner
 - 1.Alternative cleaner
 - Isopropyl alcohol (IPA)
 - 2.Aqueous agent
 - PINE ALPHA ST-100S
- (4) There shall be no residual flux and residual cleaner after cleaning.
In the case of using aqueous agent, products shall be dried completely after rinse with de-ionized water in order to remove the cleaner.
- (5) Rinsing by Ultrasonic cleaning
Using water for ultrasonic cleaning may affect the resin quality used for the product by water element .
In case of set cleaning conditions, please make sure the reliability according to the cleaning conditions.
- (6) Other cleaning
Please contact us.

10-10. Handling of a substrate

After mounting products on a substrate, do not apply any stress to the product caused by bending or twisting to the substrate when cropping the substrate, inserting and removing a connector from the substrate or tightening screw to the substrate.

Excessive mechanical stress may cause cracking in the product.

Bending

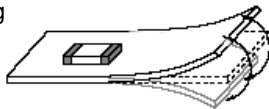

Twisting

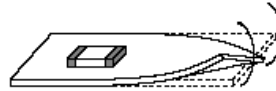

10-11. Storage Conditions

- (1) Storage period
Use the products within 6 months after delivered.
Solderability should be checked if this period is exceeded.
- (2) Storage conditions
 - Products should be stored in the warehouse on the following conditions.
Temperature : -10°C to 40°C
Humidity : 15% to 85% relative humidity
No rapid change on temperature and humidity
 - Don't keep products in corrosive gases such as sulfur, chlorine gas or acid, or it may cause oxidization of electrode, resulting in poor solderability.
 - Products should be stored on the palette for the prevention of the influence from humidity, dust and so on.
 - Products should be stored in the warehouse without heat shock, vibration, direct sunlight and so on.
 - Products should be stored under the airtight packaged condition.
- (3) Delivery
Care should be taken when transporting or handling product to avoid excessive vibration or mechanical shock.

11. ⚠ Note

- (1) Please make sure that your product has been evaluated in view of your specifications with our product being mounted to your product.
- (2) You are requested not to use our product deviating from the reference specifications.
- (3) The contents of this reference specification are subject to change without advance notice. Please approve our product specifications or transact the approval sheet for product specifications before ordering.

Компания «Life Electronics» занимается поставками электронных компонентов импортного и отечественного производства от производителей и со складов крупных дистрибьюторов Европы, Америки и Азии.

С конца 2013 года компания активно расширяет линейку поставок компонентов по направлению коаксиальный кабель, кварцевые генераторы и конденсаторы (керамические, пленочные, электролитические), за счёт заключения дистрибьюторских договоров

Мы предлагаем:

- Конкуренспособные цены и скидки постоянным клиентам.
- Специальные условия для постоянных клиентов.
- Подбор аналогов.
- Поставку компонентов в любых объемах, удовлетворяющих вашим потребностям.
- Приемлемые сроки поставки, возможна ускоренная поставка.
- Доставку товара в любую точку России и стран СНГ.
- Комплексную поставку.
- Работу по проектам и поставку образцов.
- Формирование склада под заказчика.
- Сертификаты соответствия на поставляемую продукцию (по желанию клиента).
- Тестирование поставляемой продукции.
- Поставку компонентов, требующих военную и космическую приемку.
- Входной контроль качества.
- Наличие сертификата ISO.

В составе нашей компании организован Конструкторский отдел, призванный помогать разработчикам, и инженерам.

Конструкторский отдел помогает осуществить:

- Регистрацию проекта у производителя компонентов.
- Техническую поддержку проекта.
- Защиту от снятия компонента с производства.
- Оценку стоимости проекта по компонентам.
- Изготовление тестовой платы монтаж и пусконаладочные работы.



Тел: +7 (812) 336 43 04 (многоканальный)
Email: org@lifeelectronics.ru