

TCXO/VC-TCXO
HIGH STABILITY

NEW



Product Number (Please contact us)
TG-5035CJ :X1G003841Axxx00
TG-5035CG :X1G003851Axxx00

TG - 5035CJ / CG

- Frequency range : 13 MHz to 52 MHz
- Supply voltage : 1.8 V Typ.
- Frequency / temperature characteristics : $\pm 0.5 \times 10^{-6}$ Max.
- Applications : Car navigation system, GPS
- Features : High stability, Low supply voltage (1.8 V)
- Conforms to AEC-Q200

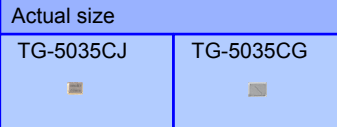
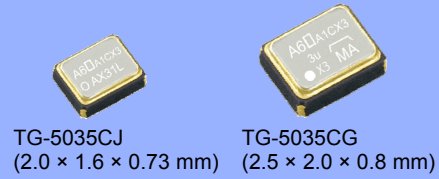

Specifications (characteristics)

Item	Symbol	Specifications		Conditions / Remarks
		VC-TCXO	TCXO	
Output frequency range	f_o	13 MHz, 16.368 MHz, 16.369 MHz, 19.2 MHz, 26 MHz, and 38.4 MHz 13.000 MHz to 52.000 MHz		Standard frequency
Supply voltage	Vcc	1.8 V ± 0.1 V (Range :1.7 V to 3.3 V)		
Storage temperature	T_stg	-40 °C to +85 °C		Storage as single product.
Operating temperature	T_use	-40 °C to +85 °C		
Frequency tolerance	f_tol	$\pm 1.5 \times 10^{-6}$ Max.		After reflow, +25 °C
Frequency/temperature characteristics	fo-Tc	$\pm 0.5 \times 10^{-6}$ Max. / -40 °C to +85 °C		
Frequency/load coefficient	fo-Load	$\pm 0.2 \times 10^{-6}$ Max.		10 k Ω // 10 pF ± 10 %
Frequency/voltage coefficient	fo-Vcc	$\pm 0.2 \times 10^{-6}$ Max.		Vcc =1.8 V ± 0.1 V
Frequency aging	f_age	$\pm 1.0 \times 10^{-6}$ Max. $\pm 1.5 \times 10^{-6}$ Max.		+25 °C , First year, 13 MHz $\leq f_o \leq 40$ MHz +25 °C , First year, 40 MHz $< f_o \leq 52$ MHz
Current consumption	Icc	2.0 mA Max.		
Input resistance	Rin	500 k Ω Min.	—	Vc- GND (DC)
Frequency control range	f_cont	$\pm 5.0 \times 10^{-6}$ to $\pm 12.0 \times 10^{-6}$	—	Vc=0.9 V ± 0.6 V (Vcc =1.8 V)
Frequency change polarity	—	Positive polarity		—
Symmetry	SYM	40 % to 60 %		GND level (DC cut)
Output voltage	Vpp	0.8 V Min.		Peak to Peak
Output load condition	Load_R	10 k Ω		DC cut capacitor = 0.01 μ F
	Load_C	10 pF		

* Note : Please contact us for requirements not listed in this specification.

External dimensions

(Unit:mm)

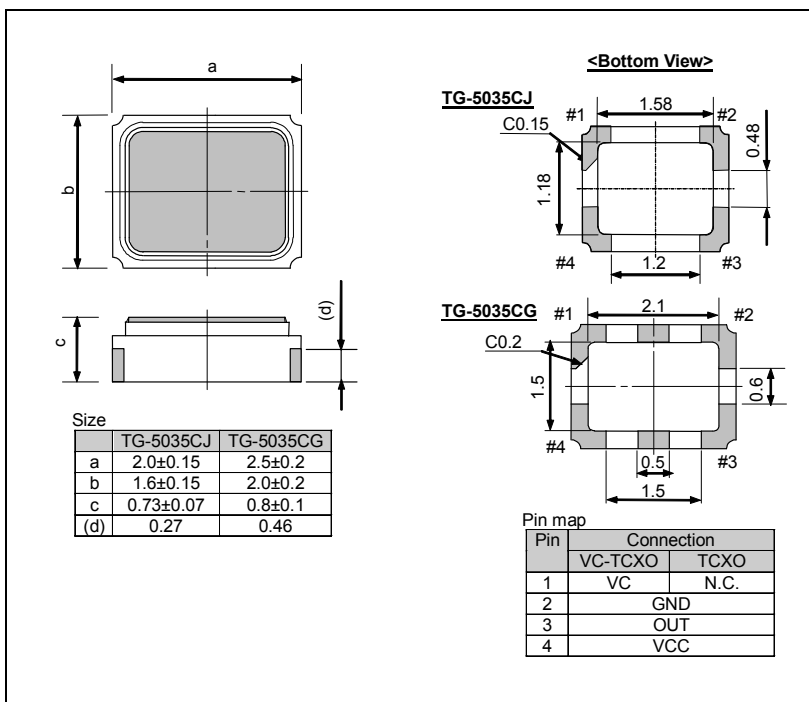

Footprint (Recommended)

(Unit:mm)

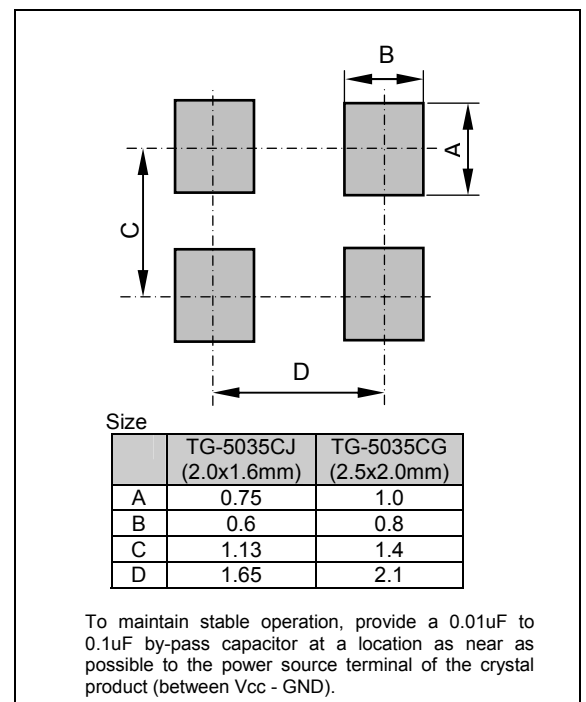

PROMOTION OF ENVIRONMENTAL MANAGEMENT SYSTEM CONFORMING TO INTERNATIONAL STANDARDS

At Seiko Epson, all environmental initiatives operate under the Plan-Do-Check-Action (PDCA) cycle designed to achieve continuous improvements. The environmental management system (EMS) operates under the ISO 14001 environmental management standard.

All of our major manufacturing and non-manufacturing sites, in Japan and overseas, completed the acquisition of ISO 14001 certification.

ISO 14000 is an international standard for environmental management that was established by the International Standards Organization in 1996 against the background of growing concern regarding global warming, destruction of the ozone layer, and global deforestation.





WORKING FOR HIGH QUALITY

In order provide high quality and reliable products and services than meet customer needs,

Seiko Epson made early efforts towards obtaining ISO9000 series certification and has acquired ISO9001 for all business establishments in Japan and abroad. We have also acquired ISO/TS 16949 certification that is requested strongly by major automotive manufacturers as standard.

ISO/TS16949 is the international standard that added the sector-specific supplemental requirements for automotive industry based on ISO9001.

► Explanation of the mark that are using it for the catalog

	► Pb free.
	► Complies with EU RoHS directive. *About the products without the Pb-free mark. Contains Pb in products exempted by EU RoHS directive. (Contains Pb in sealing glass, high melting temperature type solder or other.)
	► Designed for automotive applications such as Car Multimedia, Body Electronics, Remote Keyless Entry etc.
	► Designed for automotive applications related to driving safety (Engine Control Unit, Air Bag, ESC etc.)

Notice

- This material is subject to change without notice.
- Any part of this material may not be reproduced or duplicated in any form or any means without the written permission of Seiko Epson.
- The information about applied circuitry, software, usage, etc. written in this material is intended for reference only. Seiko Epson does not assume any liability for the occurrence of infringing on any patent or copyright of a third party. This material does not authorize the licensing for any patent or intellectual copyrights.
- When exporting the products or technology described in this material, you should comply with the applicable export control laws and regulations and follow the procedures required by such laws and regulations.
- You are requested not to use the products (and any technical information furnished, if any) for the development and/or manufacture of weapon of mass destruction or for other military purposes. You are also requested that you would not make the products available to any third party who may use the products for such prohibited purposes.
- These products are intended for general use in electronic equipment. When using them in specific applications that require extremely high reliability, such as the applications stated below, you must obtain permission from Seiko Epson in advance.
/ Space equipment (artificial satellites, rockets, etc.) / Transportation vehicles and related (automobiles, aircraft, trains, vessels, etc.) / Medical instruments to sustain life / Submarine transmitters / Power stations and related / Fire work equipment and security equipment / traffic control equipment / and others requiring equivalent reliability.
- All brands or product names mentioned herein are trademarks and/or registered trademarks of their respective.

Компания «Life Electronics» занимается поставками электронных компонентов импортного и отечественного производства от производителей и со складов крупных дистрибьюторов Европы, Америки и Азии.

С конца 2013 года компания активно расширяет линейку поставок компонентов по направлению коаксиальный кабель, кварцевые генераторы и конденсаторы (керамические, пленочные, электролитические), за счёт заключения дистрибьюторских договоров

Мы предлагаем:

- Конкурентоспособные цены и скидки постоянным клиентам.
- Специальные условия для постоянных клиентов.
- Подбор аналогов.
- Поставку компонентов в любых объемах, удовлетворяющих вашим потребностям.
- Приемлемые сроки поставки, возможна ускоренная поставка.
- Доставку товара в любую точку России и стран СНГ.
- Комплексную поставку.
- Работу по проектам и поставку образцов.
- Формирование склада под заказчика.
- Сертификаты соответствия на поставляемую продукцию (по желанию клиента).
- Тестирование поставляемой продукции.
- Поставку компонентов, требующих военную и космическую приемку.
- Входной контроль качества.
- Наличие сертификата ISO.

В составе нашей компании организован Конструкторский отдел, призванный помогать разработчикам, и инженерам.

Конструкторский отдел помогает осуществить:

- Регистрацию проекта у производителя компонентов.
- Техническую поддержку проекта.
- Защиту от снятия компонента с производства.
- Оценку стоимости проекта по компонентам.
- Изготовление тестовой платы монтаж и пусконаладочные работы.



Тел: +7 (812) 336 43 04 (многоканальный)
Email: org@lifeelectronics.ru