

# SMD/BLOCK Type EMI Suppression Filters

# EMIFIL<sup>®</sup>



*Innovator  
in Electronics*

**Murata  
Manufacturing Co., Ltd.**

△Note • Please read rating and △CAUTION (for storage, operating, rating, soldering, mounting and handling) in this catalog to prevent smoking and/or burning, etc.  
• This catalog has only typical specifications because there is no space for detailed specifications. Therefore, please review our product specifications or consult the approval sheet for product specifications before ordering.

C31E.pdf  
Mar.28,2011



## Chip EMIFIL®

|                              |     |
|------------------------------|-----|
| Series Introduction .....    | 102 |
| Part Numbering .....         | 104 |
| Series Line Up .....         | 107 |
| Product Detail .....         | 110 |
| ⚠Caution/Notice .....        | 138 |
| Soldering and Mounting ..... | 139 |
| Packaging .....              | 145 |
| Design Kits .....            | 146 |

# NF Series Introduction

Chip Ferrite Bead

Chip EMIFIL®

Chip Common Mode Choke Coil



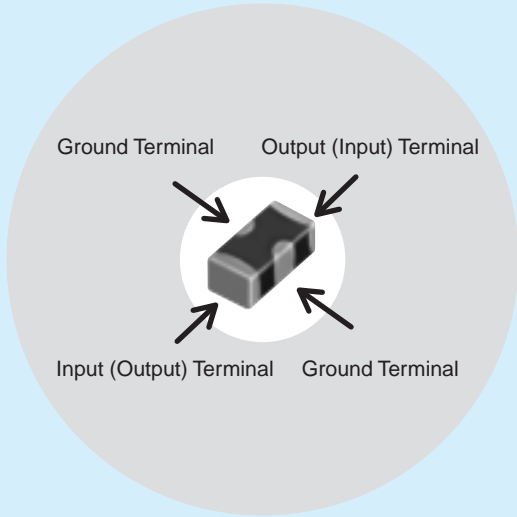











Block Type EMIFIL®



## Example of 3 Terminal Capacitor Structure

Chip 3 terminal capacitor is chip shaped 3 terminal capacitor designed for noise suppression. Its inner structure like feed through capacitor makes its ground impedance quite low. Owing to this structure, 3 terminal capacitor has good noise suppression effect at high frequency range up to several hundred MHz.



| Series                                                           | Equivalent Circuit | Part Number                                                                                                                                                                                                                                                                                                          |  |
|------------------------------------------------------------------|--------------------|----------------------------------------------------------------------------------------------------------------------------------------------------------------------------------------------------------------------------------------------------------------------------------------------------------------------|--|
| <b>NFM Series</b><br>(3 terminal capacitor)                      |                    |  <b>NFM18CC</b>                                                                                                                                                                                                                   |  |
|                                                                  |                    |  <b>NFM21CC</b>                                                                                                                                                                                                                 |  |
|                                                                  |                    |  <b>NFM18PC</b>                                                                                                                                                                                                                 |  |
|                                                                  |                    |  <b>NFM18PS</b>                                                                                                                                                                                                                 |  |
|                                                                  |                    |  <b>NFM21PC</b>                                                                                                                                                                                                                 |  |
| <b>NFL / NFW Series</b><br>(LC filter)                           |                    |  <b>NFL18ST</b>                                                                                                                                                                                                                 |  |
|                                                                  |                    |  <b>NFL18SP</b><br> <b>NFL21SP</b><br> <b>NFW31SP</b> |  |
|                                                                  |                    |  <b>NFA21S</b><br> <b>NFA18S</b>                                                                                                           |  |
| <b>NFR Series</b><br>(RC filter)                                 |                    |  <b>NFR21GD</b><br> <b>NFA31GD</b>                                                                                                         |  |
| <b>NFE Series</b><br>(Feed through capacitor with ferrite cores) |                    |  <b>NFE31PT</b><br> <b>NFE61PT</b>                                                                                                         |  |

△Note • Please read rating and △CAUTION (for storage, operating, rating, soldering, mounting and handling) in this catalog to prevent smoking and/or burning, etc.  
 • This catalog has only typical specifications because there is no space for detailed specifications. Therefore, please review our product specifications or consult the approval sheet for product specifications before ordering.

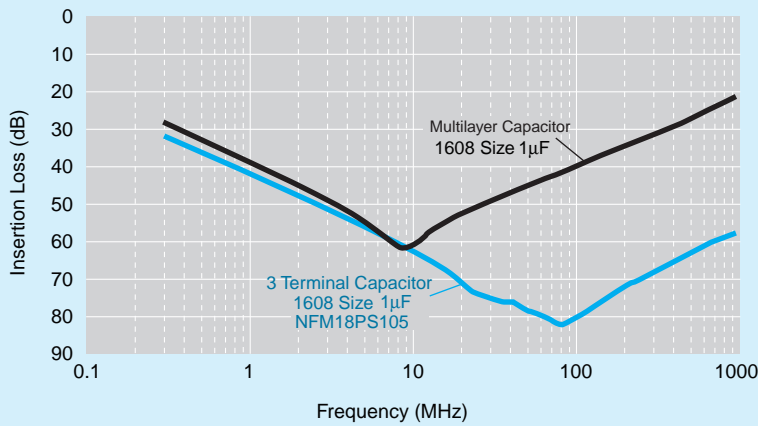

| Insertion Loss Sample | Features                                                                                  | Classification |                                                                 | Applications                                           | Example                                                                                                                                                                                            |
|-----------------------|-------------------------------------------------------------------------------------------|----------------|-----------------------------------------------------------------|--------------------------------------------------------|----------------------------------------------------------------------------------------------------------------------------------------------------------------------------------------------------|
|                       |                                                                                           | Code           | Description                                                     |                                                        |                                                                                                                                                                                                    |
|                       | Standard of 3 terminal capacitor                                                          | <b>NFM_CC</b>  | Standard type with varied capacitance                           | Noise suppression in low speed signal lines            | <ul style="list-style-type: none"> <li>Low speed interface lines,</li> <li>sensor</li> </ul>                                                                                                       |
|                       |                                                                                           | <b>NFM_PC</b>  | Meet large current, high capacitance available, for power lines | Noise suppression in power lines                       | <ul style="list-style-type: none"> <li>Individual IC power lines</li> </ul>                                                                                                                        |
|                       | Sharp insertion loss curve enables low damage to signal waveform                          | <b>NFL_ST</b>  | T-type filter, effective in low impedance circuits              | Noise suppression in high speed signal lines           | <ul style="list-style-type: none"> <li>High speed interface lines</li> <li>Bus lines</li> <li>LCD lines</li> <li>Camera I/Fs</li> <li>High speed analog lines</li> <li>RGB / D terminal</li> </ul> |
|                       |                                                                                           | <b>NFL_SP</b>  | π-type filter, effective in high impedance circuits             |                                                        |                                                                                                                                                                                                    |
|                       |                                                                                           | <b>NFW_SP</b>  | π-type filter, designed for low impedance circuits              |                                                        |                                                                                                                                                                                                    |
|                       |                                                                                           | <b>NFA_SL</b>  | 4-line array, suitable for bus lines or flat cables             |                                                        |                                                                                                                                                                                                    |
|                       | Limit noise using resistor, also loop back to ground                                      |                |                                                                 | Noise suppression in signal line with unstable ground  | <ul style="list-style-type: none"> <li>Interface lines</li> <li>Clock lines</li> </ul>                                                                                                             |
|                       | Meet large current, good high frequency performance because of its feed through structure |                |                                                                 | Noise suppression in power lines / low impedance lines | <ul style="list-style-type: none"> <li>Various power lines</li> <li>sensor</li> </ul>                                                                                                              |

△Note • Please read rating and △CAUTION (for storage, operating, rating, soldering, mounting and handling) in this catalog to prevent smoking and/or burning, etc.  
 • This catalog has only typical specifications because there is no space for detailed specifications. Therefore, please review our product specifications or consult the approval sheet for product specifications before ordering.

# NF Chip EMIFIL<sup>®</sup> Part Numbering

## Capacitor

(Part Number)

|           |          |           |           |            |          |           |          |          |
|-----------|----------|-----------|-----------|------------|----------|-----------|----------|----------|
| <b>NF</b> | <b>M</b> | <b>3D</b> | <b>CC</b> | <b>102</b> | <b>R</b> | <b>1H</b> | <b>3</b> | <b>L</b> |
| ①         | ②        | ③         | ④         | ⑤          | ⑥        | ⑦         | ⑧        | ⑨        |

### ① Product ID

| Product ID |                          |
|------------|--------------------------|
| <b>NF</b>  | Chip EMIFIL <sup>®</sup> |

### ② Structure

| Code     | Structure            |
|----------|----------------------|
| <b>M</b> | Capacitor Type       |
| <b>A</b> | Capacitor Array Type |

### ③ Dimensions (L×W)

| Code      | Dimensions (L×W) | EIA  |
|-----------|------------------|------|
| <b>18</b> | 1.6×0.8mm        | 0603 |
| <b>21</b> | 2.0×1.25mm       | 0805 |
| <b>3D</b> | 3.2×1.25mm       | 1205 |
| <b>31</b> | 3.2×1.6mm        | 1206 |
| <b>41</b> | 4.5×1.6mm        | 1806 |
| <b>55</b> | 5.7×5.0mm        | 2220 |

### ④ Features

| Code      | Features                         |
|-----------|----------------------------------|
| <b>CC</b> | Capacitor Type for Signal Lines  |
| <b>PC</b> | Capacitor Type for Large Current |
| <b>PS</b> | High Loss Type for Large Current |

### ⑤ Capacitance

Expressed by three figures. The unit is in pico-farad (pF). The first and second figures are significant digits, and the third figure expresses the number of zeros which follow the two figures.

### ⑨ Packaging

| Code     | Packaging                     | Series                         |
|----------|-------------------------------|--------------------------------|
| <b>L</b> | Embossed Taping (ø180mm Reel) | <b>NFM3D/NFM31/NFM41/NFM55</b> |
| <b>B</b> | Bulk                          | All series                     |
| <b>D</b> | Paper Taping (ø180mm Reel)    | <b>NFM18/NFM21/NFA□□CC</b>     |

### ⑥ Characteristics

| Code     | Capacitance Change (Temperature Characteristics) |
|----------|--------------------------------------------------|
| <b>B</b> | ±10%, ±12.5%, +10/-13%                           |
| <b>F</b> | +30/-80%, +30/-84%                               |
| <b>R</b> | ±15%, +15/-18%                                   |
| <b>U</b> | -750 ±120ppm/°C                                  |
| <b>S</b> | +350 to -1000ppm/°C                              |

### ⑦ Rated Voltage

| Code      | Rated Voltage |
|-----------|---------------|
| <b>0J</b> | 6.3V          |
| <b>1A</b> | 10V           |
| <b>1C</b> | 16V           |
| <b>1E</b> | 25V           |
| <b>1H</b> | 50V           |
| <b>2A</b> | 100V          |

### ⑧ Electrode/Others (NFM Series)

| Code     | Electrode      | Series                            |
|----------|----------------|-----------------------------------|
| <b>3</b> | Sn Plating     | <b>NFM</b> (Except <b>NFM55</b> ) |
| <b>4</b> | Solder Coating | <b>NFM55</b>                      |

### ⑧ Number of Circuits (NFA□□CC Series)

| Code     | Number of Circuits |
|----------|--------------------|
| <b>4</b> | 4 Circuits         |

△Note • Please read rating and △CAUTION (for storage, operating, rating, soldering, mounting and handling) in this catalog to prevent smoking and/or burning, etc.  
• This catalog has only typical specifications because there is no space for detailed specifications. Therefore, please review our product specifications or consult the approval sheet for product specifications before ordering.

## LC Combined (1)

(Part Number)

|    |   |    |    |     |   |    |   |   |
|----|---|----|----|-----|---|----|---|---|
| NF | L | 18 | ST | 107 | X | 1C | 3 | L |
| ①  | ② | ③  | ④  | ⑤   | ⑥ | ⑦  | ⑧ | ⑨ |

### ① Product ID

| Product ID |              |
|------------|--------------|
| NF         | Chip EMIFIL® |

### ② Structure

| Code | Structure                    |
|------|------------------------------|
| L    | Multilayer, LC Combined Type |
| W    | Wire Wound, LC Combined Type |
| E    | Block, LC Combined Type      |

### ③ Dimensions (L×W)

| Code | Dimensions (L×W) | EIA  |
|------|------------------|------|
| 18   | 1.6×0.8mm        | 0603 |
| 21   | 2.0×1.25mm       | 0805 |
| 31   | 3.2×1.6mm        | 1206 |
| 61   | 6.8×1.6mm        | 2606 |

### ④ Features

| Code | Features                    |
|------|-----------------------------|
| SP   | π Circuit for Signal Lines  |
| ST   | T Circuit for Signal Lines  |
| PT   | T Circuit for Large Current |

### ⑤ Cut-off Frequency (NFL/NFW Series)

Expressed by three figures. The unit is in hertz (Hz). The first and second figures are significant digits, and the third figure expresses the number of zeros which follow the two figures.

### ⑤ Capacitance (NFE Series)

Expressed by three figures. The unit is in pico-farad (pF). The first and second figures are significant digits, and the third figure expresses the number of zeros which follow the two figures.

### ⑨ Packaging

| Code | Packaging                     | Series          |
|------|-------------------------------|-----------------|
| K    | Embossed Taping (ø330mm Reel) | NFW31/NFE       |
| L    | Embossed Taping (ø180mm Reel) | NFW31/NFE       |
| B    | Bulk                          | NFL18/NFL21/NFE |
| D    | Paper Taping (ø180mm Reel)    | NFL18/NFL21     |

### ⑥ Characteristics (NFL/NFW Series)

| Code | Characteristics   |
|------|-------------------|
| X    | Cut-off Frequency |

### ⑥ Characteristics (NFE Series)

| Code | Capacitance Change (Temperature Characteristics) |
|------|--------------------------------------------------|
| B    | ±10%                                             |
| C    | ±20%, ±22%                                       |
| D    | +20/-30%, +22/-33%                               |
| E    | +20/-55%, +22/-56%                               |
| F    | +30/-80%, +22/-82%                               |
| R    | ±15%                                             |
| U    | -750 ±120ppm/ °C                                 |
| Z    | Other                                            |

### ⑦ Rated Voltage

| Code | Rated Voltage |
|------|---------------|
| 1A   | 10V           |
| 1C   | 16V           |
| 1E   | 25V           |
| 1H   | 50V           |
| 2A   | 100V          |

### ⑧ Electrode

| Code | Electrode                | Series |
|------|--------------------------|--------|
| 3/7  | Sn Plating               | NFL    |
| 4    | Lead Free Solder Coating | NFW    |
| 9    | Others                   | NFE    |

△Note • Please read rating and △CAUTION (for storage, operating, rating, soldering, mounting and handling) in this catalog to prevent smoking and/or burning, etc.  
 • This catalog has only typical specifications because there is no space for detailed specifications. Therefore, please review our product specifications or consult the approval sheet for product specifications before ordering.

### LC Combined (2)



① Product ID

| Product ID |              |
|------------|--------------|
| <b>NF</b>  | Chip EMIFIL® |

② Structure

| Code     | Structure  |
|----------|------------|
| <b>A</b> | Array Type |

③ Dimensions (L×W)

| Code      | Dimensions (L×W) | EIA  |
|-----------|------------------|------|
| <b>18</b> | 1.6×0.8mm        | 0603 |
| <b>21</b> | 2.0×1.25mm       | 0805 |

④ Features (1)

| Code      | Features                          |
|-----------|-----------------------------------|
| <b>SL</b> | L Circuit for Signal Lines        |
| <b>SD</b> | L Circuit for Differential Signal |

⑤ Cut-off Frequency

Expressed by three figures. The unit is in hertz (Hz). The first and second figures are significant digits, and the third figure expresses the number of zeros which follow the two figures.

⑥ Features (2)

| Code     | Features              |
|----------|-----------------------|
| <b>X</b> | Expressed by a letter |
| <b>V</b> |                       |

⑦ Rated Voltage

| Code      | Rated Voltage |
|-----------|---------------|
| <b>1A</b> | 10V           |

⑧ Number of Circuits

| Code     | Number of Circuits |
|----------|--------------------|
| <b>4</b> | 4 Circuits         |

⑨ Dimensions (T)

| Code     | Dimensions (T) |
|----------|----------------|
| <b>5</b> | Low Profile    |
| <b>8</b> | Standard       |

⑩ Packaging

| Code     | Packaging                     |
|----------|-------------------------------|
| <b>B</b> | Bulk                          |
| <b>L</b> | Embossed Taping (ø180mm Reel) |

### RC Combined

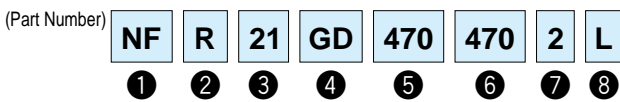

① Product ID

| Product ID |              |
|------------|--------------|
| <b>NF</b>  | Chip EMIFIL® |

② Structure

| Code     | Structure              |
|----------|------------------------|
| <b>R</b> | RC Combined Type       |
| <b>A</b> | RC Combined Array Type |

③ Dimensions (L×W)

| Code      | Dimensions (L×W) | EIA  |
|-----------|------------------|------|
| <b>21</b> | 2.0×1.25mm       | 0805 |
| <b>31</b> | 3.2×1.6mm        | 1206 |

④ Features

| Code      | Features                          |
|-----------|-----------------------------------|
| <b>GD</b> | RC Combined Type for Signal Lines |

⑧ Packaging

| Code     | Packaging                     | Series         |
|----------|-------------------------------|----------------|
| <b>L</b> | Embossed Taping (ø180mm Reel) | <b>NFR</b>     |
| <b>B</b> | Bulk                          | All Series     |
| <b>D</b> | Paper Taping (ø180mm Reel)    | <b>NFA□□GD</b> |

⑤ Capacitance

Expressed by three figures. The unit is in pico-farad (pF). The first and second figures are significant digits, and the third figure expresses the number of zeros which follow the two figures.

⑥ Resistance

Expressed by three-digit alphanumerics. The unit is in ohm (Ω). The first and second figures are significant digits, and the third figure expresses the number of zeros which follow the two figures. If there is a decimal point, it is expressed by the capital letter "R". In this case, all figures are significant digits.

⑦ Electrode/Others (NFR Series)

| Code     | Electrode  |
|----------|------------|
| <b>2</b> | Sn Plating |

⑦ Number of Circuits (NFA□□GD Series)

| Code     | Number of Circuits |
|----------|--------------------|
| <b>4</b> | 4 Circuits         |

△Note • Please read rating and △CAUTION (for storage, operating, rating, soldering, mounting and handling) in this catalog to prevent smoking and/or burning, etc.  
 • This catalog has only typical specifications because there is no space for detailed specifications. Therefore, please review our product specifications or consult the approval sheet for product specifications before ordering.

| Type                                  | Size Code (Inch) | Thickness (mm) | Part Number    | Rated Voltage  | Capacitance   | Nominal Cut-off Frequency | Rated Current | New    | Kit | ≥1A | ≥3A | DTV | Flow   | ReFlow |        |
|---------------------------------------|------------------|----------------|----------------|----------------|---------------|---------------------------|---------------|--------|-----|-----|-----|-----|--------|--------|--------|
| Capacitor Type for Signal Lines       | 0603             | p120           | 0.6            | NFM18CC220U1C3 | 16Vdc         | 22pF+20%-20%              | -             | 400mA  | Kit |     |     |     |        | ReFlow |        |
|                                       |                  |                | 0.6            | NFM18CC470U1C3 | 16Vdc         | 47pF+20%-20%              | -             | 400mA  | Kit |     |     |     |        |        | ReFlow |
|                                       |                  |                | 0.6            | NFM18CC101R1C3 | 16Vdc         | 100pF+20%-20%             | -             | 500mA  | Kit |     |     |     |        |        | ReFlow |
|                                       |                  |                | 0.6            | NFM18CC221R1C3 | 16Vdc         | 220pF+20%-20%             | -             | 500mA  | Kit |     |     |     |        |        | ReFlow |
|                                       |                  |                | 0.6            | NFM18CC471R1C3 | 16Vdc         | 470pF+20%-20%             | -             | 500mA  | Kit |     |     |     |        |        | ReFlow |
|                                       |                  |                | 0.6            | NFM18CC102R1C3 | 16Vdc         | 1000pF+20%-20%            | -             | 600mA  | Kit |     |     |     |        |        | ReFlow |
|                                       |                  |                | 0.6            | NFM18CC222R1C3 | 16Vdc         | 2200pF+20%-20%            | -             | 700mA  | Kit |     |     |     |        |        | ReFlow |
|                                       | 0805             | p121           | 0.85           | NFM21CC220U1H3 | 50Vdc         | 22pF+20%-20%              | -             | 700mA  | Kit |     | ≥1A |     |        |        | ReFlow |
|                                       |                  |                | 0.85           | NFM21CC470U1H3 | 50Vdc         | 47pF+20%-20%              | -             | 700mA  | Kit |     |     |     |        |        | ReFlow |
|                                       |                  |                | 0.85           | NFM21CC101U1H3 | 50Vdc         | 100pF+20%-20%             | -             | 700mA  | Kit |     |     |     |        |        | ReFlow |
|                                       |                  |                | 0.85           | NFM21CC221R1H3 | 50Vdc         | 220pF+20%-20%             | -             | 700mA  | Kit |     |     |     |        |        | ReFlow |
|                                       |                  |                | 0.85           | NFM21CC471R1H3 | 50Vdc         | 470pF+20%-20%             | -             | 1000mA | Kit |     | ≥1A |     |        |        | ReFlow |
|                                       |                  |                | 0.85           | NFM21CC102R1H3 | 50Vdc         | 1000pF+20%-20%            | -             | 1000mA | Kit |     | ≥1A |     |        |        | ReFlow |
|                                       |                  |                | 0.85           | NFM21CC222R1H3 | 50Vdc         | 2200pF+20%-20%            | -             | 1000mA | Kit |     | ≥1A |     |        |        | ReFlow |
|                                       | 1205             | p122           | 0.7            | NFM3DCC220U1H3 | 50Vdc         | 22pF+50%-20%              | -             | 300mA  |     |     |     |     |        | Flow   | ReFlow |
|                                       |                  |                | 0.7            | NFM3DCC470U1H3 | 50Vdc         | 47pF+50%-20%              | -             | 300mA  |     |     |     |     |        | Flow   | ReFlow |
|                                       |                  |                | 0.7            | NFM3DCC101U1H3 | 50Vdc         | 100pF+50%-20%             | -             | 300mA  |     |     |     |     |        | Flow   | ReFlow |
|                                       |                  |                | 0.7            | NFM3DCC221R1H3 | 50Vdc         | 220pF+50%-20%             | -             | 300mA  |     |     |     |     |        | Flow   | ReFlow |
|                                       |                  |                | 0.7            | NFM3DCC471R1H3 | 50Vdc         | 470pF+50%-20%             | -             | 300mA  |     |     |     |     |        | Flow   | ReFlow |
|                                       |                  |                | 0.7            | NFM3DCC102R1H3 | 50Vdc         | 1000pF+50%-20%            | -             | 300mA  |     |     |     |     |        | Flow   | ReFlow |
|                                       |                  |                | 0.7            | NFM3DCC222R1H3 | 50Vdc         | 2200pF+50%-20%            | -             | 300mA  |     |     |     |     |        | Flow   | ReFlow |
|                                       | 1806             | p123           | 1.0            | NFM41CC220U2A3 | 100Vdc        | 22pF+50%-20%              | -             | 300mA  |     |     |     |     |        | Flow   | ReFlow |
|                                       |                  |                | 1.0            | NFM41CC470U2A3 | 100Vdc        | 47pF+50%-20%              | -             | 300mA  |     |     |     |     |        | Flow   | ReFlow |
|                                       |                  |                | 1.0            | NFM41CC101U2A3 | 100Vdc        | 100pF+50%-20%             | -             | 300mA  |     |     |     |     |        | Flow   | ReFlow |
|                                       |                  |                | 1.0            | NFM41CC221U2A3 | 100Vdc        | 220pF+50%-20%             | -             | 300mA  |     |     |     |     |        | Flow   | ReFlow |
|                                       |                  |                | 1.0            | NFM41CC471R2A3 | 100Vdc        | 470pF+50%-20%             | -             | 300mA  |     |     |     |     |        | Flow   | ReFlow |
|                                       |                  |                | 1.0            | NFM41CC102R2A3 | 100Vdc        | 1000pF+50%-20%            | -             | 300mA  |     |     |     |     |        | Flow   | ReFlow |
|                                       |                  |                | 1.0            | NFM41CC222R2A3 | 100Vdc        | 2200pF+50%-20%            | -             | 300mA  |     |     |     |     |        | Flow   | ReFlow |
| Capacitor Array Type for Signal Lines | 1206             | p124           | 0.8            | NFA31CC220S1E4 | 25Vdc         | 22pF+20%-20%              | -             | 200mA  | Kit |     |     |     |        | ReFlow |        |
|                                       |                  |                | 0.8            | NFA31CC470S1E4 | 25Vdc         | 47pF+20%-20%              | -             | 200mA  | Kit |     |     |     |        | ReFlow |        |
|                                       |                  |                | 0.8            | NFA31CC101S1E4 | 25Vdc         | 100pF+20%-20%             | -             | 200mA  | Kit |     |     |     |        | ReFlow |        |
|                                       |                  |                | 0.8            | NFA31CC221S1E4 | 25Vdc         | 220pF+20%-20%             | -             | 200mA  | Kit |     |     |     |        | ReFlow |        |
|                                       |                  |                | 0.8            | NFA31CC471R1E4 | 25Vdc         | 470pF+20%-20%             | -             | 200mA  | Kit |     |     |     |        | ReFlow |        |
|                                       |                  |                | 0.8            | NFA31CC102R1E4 | 25Vdc         | 1000pF+20%-20%            | -             | 200mA  | Kit |     |     |     |        | ReFlow |        |
|                                       |                  |                | 0.8            | NFA31CC222R1E4 | 25Vdc         | 2200pF+20%-20%            | -             | 200mA  | Kit |     |     |     |        | ReFlow |        |
|                                       |                  |                | 0.8            | NFA31CC223R1C4 | 16Vdc         | 22000pF+20%-20%           | -             | 200mA  | Kit |     |     |     |        | ReFlow |        |
| Capacitor Type for Power Lines        | 0603             | p112           | 0.6            | NFM18PS474R0J3 | 6.3Vdc        | 0.47μF+20%-20%            | -             | 2A     | Kit | ≥1A |     |     |        | ReFlow |        |
|                                       |                  |                | 0.6            | NFM18PS105R0J3 | 6.3Vdc        | 1.0μF+20%-20%             | -             | 2A     | Kit | ≥1A |     |     |        | ReFlow |        |
|                                       | 0805             | p113           | 0.6            | NFM18PC104R1C3 | 16Vdc         | 0.1μF+20%-20%             | -             | 2A     | Kit | ≥1A |     |     |        | ReFlow |        |
|                                       |                  |                | 0.6            | NFM18PC224R0J3 | 6.3Vdc        | 0.22μF+20%-20%            | -             | 2A     | Kit | ≥1A |     |     |        | ReFlow |        |
|                                       |                  |                | 0.6            | NFM18PC474R0J3 | 6.3Vdc        | 0.47μF+20%-20%            | -             | 2A     | Kit | ≥1A |     |     |        | ReFlow |        |
|                                       |                  |                | 0.8            | NFM18PC105R0J3 | 6.3Vdc        | 1.0μF+20%-20%             | -             | 4A     | Kit | ≥1A |     |     |        | ReFlow |        |
|                                       |                  |                | 0.6            | NFM18PC225B0J3 | 6.3Vdc        | 2.2μF+20%-20%             | -             | 2A     | Kit | ≥1A |     |     |        | ReFlow |        |
|                                       |                  |                | 0.8            | NFM18PC225B1A3 | 10Vdc         | 2.2μF+20%-20%             | -             | 4A     | Kit | ≥3A |     |     |        | ReFlow |        |
|                                       | 1205             | p115           | 0.85           | NFM21PC104R1E3 | 25Vdc         | 0.1μF+20%-20%             | -             | 2A     | Kit | ≥1A |     |     |        | ReFlow |        |
|                                       |                  |                | 0.85           | NFM21PC224R1C3 | 16Vdc         | 0.22μF+20%-20%            | -             | 2A     | Kit | ≥1A |     |     |        | ReFlow |        |
|                                       |                  |                | 0.85           | NFM21PC474R1C3 | 16Vdc         | 0.47μF+20%-20%            | -             | 2A     | Kit | ≥1A |     |     |        | ReFlow |        |
|                                       |                  |                | 0.85           | NFM21PC105B1A3 | 10Vdc         | 1.0μF+20%-20%             | -             | 4A     | Kit | ≥3A |     |     |        | ReFlow |        |
|                                       |                  |                | 0.85           | NFM21PC105B1C3 | 16Vdc         | 1.0μF+20%-20%             | -             | 4A     | Kit | ≥3A |     |     |        | ReFlow |        |
|                                       |                  |                | 0.85           | NFM21PC225B0J3 | 6.3Vdc        | 2.2μF+20%-20%             | -             | 4A     | Kit | ≥3A |     |     |        | ReFlow |        |
|                                       | 1806             | p118           | 1.0            | NFM41PC204F1H3 | 50Vdc         | 0.2μF+80%-20%             | -             | 2A     | Kit | ≥1A |     |     |        | Flow   | ReFlow |
|                                       |                  |                | 1.0            | NFM41PC155B1E3 | 25Vdc         | 1.5μF+20%-20%             | -             | 6A     | Kit | ≥3A |     |     |        | Flow   | ReFlow |
| 2220                                  | p119             | 2.2            | NFM55PC155F1H4 | 50Vdc          | 1.5μF+80%-20% | -                         | 6A            |        | ≥3A |     |     |     | ReFlow |        |        |

Continued on the following page.

△Note • Please read rating and △CAUTION (for storage, operating, rating, soldering, mounting and handling) in this catalog to prevent smoking and/or burning, etc.  
 • This catalog has only typical specifications because there is no space for detailed specifications. Therefore, please review our product specifications or consult the approval sheet for product specifications before ordering.



NF Chip EMIFIL® Series Line Up

| Type                                              | Size Code (Inch) | Thickness (mm) | Part Number     | Rated Voltage   | Capacitance    | Nominal Cut-off Frequency | Rated Current | New   | Kit | ≥1A  | ≥3A    | DTV    | Flow   | ReFlow |        |
|---------------------------------------------------|------------------|----------------|-----------------|-----------------|----------------|---------------------------|---------------|-------|-----|------|--------|--------|--------|--------|--------|
| LC Combined Type for Power Lines and Signal Lines | p110             | 1206           | NFE31PT220R1E9  | 25Vdc           | 22pF+30%-30%   | -                         | 6A            |       |     | ≥3A  |        |        |        | ReFlow |        |
|                                                   |                  |                | NFE31PT470C1E9  | 25Vdc           | 47pF+50%-20%   | -                         | 6A            |       |     | ≥3A  |        |        |        | ReFlow |        |
|                                                   |                  |                | NFE31PT101C1E9  | 25Vdc           | 100pF+80%-20%  | -                         | 6A            |       |     | ≥3A  |        |        |        | ReFlow |        |
|                                                   |                  |                | NFE31PT221D1E9  | 25Vdc           | 220pF+50%-20%  | -                         | 6A            |       |     | ≥3A  |        |        |        | ReFlow |        |
|                                                   |                  |                | NFE31PT471F1E9  | 25Vdc           | 470pF+50%-20%  | -                         | 6A            |       |     | ≥3A  |        |        |        | ReFlow |        |
|                                                   |                  |                | NFE31PT152Z1E9  | 25Vdc           | 1500pF+50%-20% | -                         | 6A            |       |     | Kit  | ≥3A    |        |        |        | ReFlow |
|                                                   | p111             | 2706           | NFE31PT222Z1E9  | 25Vdc           | 2200pF+50%-50% | -                         | 6A            |       |     | Kit  | ≥3A    |        |        |        | ReFlow |
|                                                   |                  |                | NFE61PT330B1H9  | 50Vdc           | 33pF+30%-30%   | -                         | 2A            |       |     | ≥1A  |        | Flow   | ReFlow |        |        |
|                                                   |                  |                | NFE61PT680B1H9  | 50Vdc           | 68pF+30%-30%   | -                         | 2A            |       |     | ≥1A  |        | Flow   | ReFlow |        |        |
|                                                   |                  |                | NFE61PT101Z1H9  | 50Vdc           | 100pF+30%-30%  | -                         | 2A            |       |     | ≥1A  |        | Flow   | ReFlow |        |        |
|                                                   |                  |                | NFE61PT181B1H9  | 50Vdc           | 180pF+30%-30%  | -                         | 2A            |       |     | ≥1A  |        | Flow   | ReFlow |        |        |
|                                                   |                  |                | NFE61PT361B1H9  | 50Vdc           | 360pF+20%-20%  | -                         | 2A            |       |     | ≥1A  |        | Flow   | ReFlow |        |        |
|                                                   |                  |                | NFE61PT681B1H9  | 50Vdc           | 680pF+30%-30%  | -                         | 2A            |       |     | ≥1A  |        | Flow   | ReFlow |        |        |
|                                                   |                  |                | NFE61PT102E1H9  | 50Vdc           | 1000pF+80%-20% | -                         | 2A            |       |     | Kit  | ≥1A    |        | Flow   | ReFlow |        |
| NFE61PT472C1H9                                    | 50Vdc            | 4700pF+80%-20% | -               | 2A              |                |                           | Kit           | ≥1A   |     | Flow | ReFlow |        |        |        |        |
| LC Combined Multilayer Type for Signal Lines      | p125             | 0603           | NFL18ST506H1A3  | 10Vdc           | 110pF (Typ.)   | 50MHz                     | 75mA          | New   | Kit |      |        | DTV    |        | ReFlow |        |
|                                                   |                  |                | NFL18ST706H1A3  | 10Vdc           | 70pF (Typ.)    | 70MHz                     | 75mA          | New   | Kit |      |        | DTV    |        | ReFlow |        |
|                                                   |                  |                | NFL18ST107H1A3  | 10Vdc           | 50pF (Typ.)    | 100MHz                    | 75mA          | New   | Kit |      |        | DTV    |        | ReFlow |        |
|                                                   | p126             | 0603           | NFL18ST207X1C3  | 16Vdc           | 25pF+20%-20%   | 200MHz                    | 150mA         |       | Kit |      |        |        |        | ReFlow |        |
|                                                   |                  |                | NFL18ST307X1C3  | 16Vdc           | 18pF+20%-20%   | 300MHz                    | 200mA         |       | Kit |      |        |        |        | ReFlow |        |
|                                                   |                  |                | NFL18ST507X1C3  | 16Vdc           | 10pF+20%-20%   | 500MHz                    | 200mA         |       | Kit |      |        |        |        | ReFlow |        |
|                                                   | p127             | 0603           | NFL18SP157X1A3  | 10Vdc           | 34pF+20%-20%   | 150MHz                    | 100mA         |       | Kit |      |        |        |        | ReFlow |        |
|                                                   |                  |                | NFL18SP207X1A3  | 10Vdc           | 24pF+20%-20%   | 200MHz                    | 100mA         |       | Kit |      |        |        |        | ReFlow |        |
|                                                   |                  |                | NFL18SP307X1A3  | 10Vdc           | 19pF+20%-20%   | 300MHz                    | 100mA         |       | Kit |      |        |        |        | ReFlow |        |
|                                                   |                  |                | NFL18SP507X1A3  | 10Vdc           | 11pF+20%-20%   | 500MHz                    | 100mA         |       | Kit |      |        |        |        | ReFlow |        |
|                                                   | p128             | 0805           | NFL21SP106X1C3  | 16Vdc           | 670pF+20%-20%  | 10MHz                     | 100mA         |       | Kit |      |        |        |        | ReFlow |        |
|                                                   |                  |                | NFL21SP206X1C7  | 16Vdc           | 240pF+20%-20%  | 20MHz                     | 100mA         |       | Kit |      |        |        |        | ReFlow |        |
|                                                   |                  |                | NFL21SP506X1C3  | 16Vdc           | 84pF+20%-20%   | 50MHz                     | 150mA         |       | Kit |      |        |        |        | ReFlow |        |
|                                                   |                  |                | NFL21SP706X1C3  | 16Vdc           | 76pF+20%-20%   | 70MHz                     | 150mA         |       | Kit |      |        |        |        | ReFlow |        |
|                                                   |                  |                | NFL21SP107X1C3  | 16Vdc           | 44pF+20%-20%   | 100MHz                    | 200mA         |       | Kit |      |        |        |        | ReFlow |        |
|                                                   |                  |                | NFL21SP157X1C3  | 16Vdc           | 28pF+20%-20%   | 150MHz                    | 200mA         |       | Kit |      |        |        |        | ReFlow |        |
|                                                   |                  |                | NFL21SP207X1C3  | 16Vdc           | 22pF+20%-20%   | 200MHz                    | 250mA         |       | Kit |      |        |        |        | ReFlow |        |
|                                                   |                  |                | NFL21SP307X1C3  | 16Vdc           | 19pF+10%-10%   | 300MHz                    | 300mA         |       | Kit |      |        |        |        | ReFlow |        |
|                                                   |                  |                | NFL21SP407X1C3  | 16Vdc           | 16pF+10%-10%   | 400MHz                    | 300mA         |       | Kit |      |        |        |        | ReFlow |        |
|                                                   | NFL21SP507X1C3   | 16Vdc          | 12pF+10%-10%    | 500MHz          | 300mA          |                           | Kit           |       |     |      |        | ReFlow |        |        |        |
| LC Combined Array Type for Signal Lines           | p129             | 0603           | NFA18SL137V1A45 | 10Vdc           | -              | 130MHz                    | 50mA          |       | Kit |      |        | DTV    |        | ReFlow |        |
|                                                   |                  |                | NFA18SL187V1A45 | 10Vdc           | -              | 180MHz                    | 50mA          |       | Kit |      |        | DTV    |        | ReFlow |        |
|                                                   |                  |                | NFA18SL207V1A45 | 10Vdc           | -              | 200MHz                    | 50mA          |       | Kit |      |        |        | DTV    |        | ReFlow |
|                                                   |                  |                | NFA18SL227V1A45 | 10Vdc           | -              | 220MHz                    | 25mA          |       | Kit |      |        |        | DTV    |        | ReFlow |
|                                                   |                  |                | NFA18SL307V1A45 | 10Vdc           | -              | 300MHz                    | 100mA         |       | Kit |      |        |        |        |        | ReFlow |
|                                                   |                  |                | NFA18SL357V1A45 | 10Vdc           | -              | 350MHz                    | 35mA          | New   | Kit |      |        |        |        |        | ReFlow |
|                                                   |                  |                | NFA18SL407V1A45 | 10Vdc           | -              | 400MHz                    | 100mA         |       | Kit |      |        |        |        |        | ReFlow |
|                                                   | p130             | 0603           | NFA18SL487V1A45 | 10Vdc           | -              | 480MHz                    | 100mA         |       | Kit |      |        |        |        | ReFlow |        |
|                                                   |                  |                | NFA18SL506X1A45 | 10Vdc           | -              | 50MHz                     | 25mA          |       | Kit |      |        |        |        | ReFlow |        |
|                                                   | p131             | 0603           | NFA18SD187X1A45 | 10Vdc           | -              | 180MHz                    | 25mA          |       | Kit |      |        |        | DTV    |        | ReFlow |
|                                                   |                  |                | NFA18SD207X1A45 | 10Vdc           | -              | 200MHz                    | 25mA          |       | Kit |      |        |        | DTV    |        | ReFlow |
|                                                   | p132             | 0805           | NFA21SL287V1A45 | 10Vdc           | -              | 280MHz                    | 100mA         |       | Kit |      |        |        |        | ReFlow |        |
|                                                   |                  |                | NFA21SL317V1A45 | 10Vdc           | -              | 310MHz                    | 100mA         |       | Kit |      |        |        |        | ReFlow |        |
|                                                   |                  |                | NFA21SL337V1A45 | 10Vdc           | -              | 330MHz                    | 100mA         |       | Kit |      |        |        |        | ReFlow |        |
|                                                   |                  |                | NFA21SL287V1A48 | 10Vdc           | -              | 280MHz                    | 100mA         |       | Kit |      |        |        |        | ReFlow |        |
|                                                   |                  |                | NFA21SL317V1A48 | 10Vdc           | -              | 310MHz                    | 100mA         |       | Kit |      |        |        |        | ReFlow |        |
|                                                   |                  |                | NFA21SL337V1A48 | 10Vdc           | -              | 330MHz                    | 100mA         |       | Kit |      |        |        |        | ReFlow |        |
| p133                                              |                  |                | 0805            | NFA21SL207X1A45 | 10Vdc          | -                         | 200MHz        | 100mA |     | Kit  |        |        |        |        | ReFlow |
|                                                   |                  |                |                 | NFA21SL307X1A45 | 10Vdc          | -                         | 300MHz        | 100mA |     | Kit  |        |        |        |        | ReFlow |
|                                                   | NFA21SL506X1A48  | 10Vdc          |                 | -               | 50MHz          | 20mA                      |               | Kit   |     |      |        |        | ReFlow |        |        |
|                                                   | NFA21SL806X1A48  | 10Vdc          |                 | -               | 80MHz          | 20mA                      |               | Kit   |     |      |        |        | ReFlow |        |        |
|                                                   | NFA21SL207X1A48  | 10Vdc          |                 | -               | 200MHz         | 100mA                     |               | Kit   |     |      |        |        | ReFlow |        |        |
| NFA21SL307X1A48                                   | 10Vdc            | -              | 300MHz          | 100mA           |                | Kit                       |               |       |     |      | ReFlow |        |        |        |        |

Continued on the following page. ↗

△Note • Please read rating and △CAUTION (for storage, operating, rating, soldering, mounting and handling) in this catalog to prevent smoking and/or burning, etc.  
 • This catalog has only typical specifications because there is no space for detailed specifications. Therefore, please review our product specifications or consult the approval sheet for product specifications before ordering.

| Type                                         | Size Code (Inch) | Thickness (mm) | Part Number   | Rated Voltage  | Capacitance | Nominal Cut-off Frequency | Rated Current | New  | Kit | ≥1A | ≥3A    | DTV | Flow | ReFlow |
|----------------------------------------------|------------------|----------------|---------------|----------------|-------------|---------------------------|---------------|------|-----|-----|--------|-----|------|--------|
| LC Combined Wire Wound Type for Signal Lines | p134             | 1206           | 1.8           | NFW31SP106X1E4 | -           | -                         | 10MHz         | -    | Kit |     |        |     | Flow | ReFlow |
|                                              |                  |                | 1.8           | NFW31SP206X1E4 | -           | -                         | 20MHz         | -    | Kit |     |        |     | Flow | ReFlow |
|                                              |                  |                | 1.8           | NFW31SP506X1E4 | -           | -                         | 50MHz         | -    | Kit |     |        |     | Flow | ReFlow |
|                                              |                  |                | 1.8           | NFW31SP107X1E4 | -           | -                         | 100MHz        | -    | Kit |     |        |     | Flow | ReFlow |
|                                              |                  |                | 1.8           | NFW31SP157X1E4 | -           | -                         | 150MHz        | -    | Kit |     |        |     | Flow | ReFlow |
|                                              |                  |                | 1.8           | NFW31SP207X1E4 | -           | -                         | 200MHz        | -    | Kit |     |        |     | Flow | ReFlow |
|                                              |                  |                | 1.8           | NFW31SP307X1E4 | -           | -                         | 300MHz        | -    | Kit |     |        |     | Flow | ReFlow |
|                                              |                  |                | 1.8           | NFW31SP407X1E4 | -           | -                         | 400MHz        | -    | Kit |     |        |     | Flow | ReFlow |
| RC Combined Type for Signal Lines            | p136             | 0805           | 0.5           | NFR21GD1002202 | 50Vdc       | 10pF+20%-20%              | -             | 50mA |     |     |        |     |      | ReFlow |
|                                              |                  |                | 0.5           | NFR21GD1004702 | 50Vdc       | 10pF+20%-20%              | -             | 35mA |     |     |        |     |      | ReFlow |
|                                              |                  |                | 0.5           | NFR21GD4702202 | 50Vdc       | 47pF+20%-20%              | -             | 50mA |     |     |        |     |      | ReFlow |
|                                              |                  |                | 0.5           | NFR21GD4704702 | 50Vdc       | 47pF+20%-20%              | -             | 35mA |     |     |        |     |      | ReFlow |
|                                              |                  |                | 0.5           | NFR21GD4706802 | 50Vdc       | 47pF+20%-20%              | -             | 30mA |     |     |        |     |      | ReFlow |
|                                              |                  |                | 0.5           | NFR21GD4701012 | 50Vdc       | 47pF+20%-20%              | -             | 25mA |     |     |        |     |      | ReFlow |
|                                              |                  |                | 0.5           | NFR21GD1012202 | 50Vdc       | 100pF+20%-20%             | -             | 50mA |     |     |        |     |      | ReFlow |
|                                              |                  |                | 0.5           | NFR21GD1014702 | 50Vdc       | 100pF+20%-20%             | -             | 35mA |     |     |        |     |      | ReFlow |
|                                              |                  |                | 0.5           | NFR21GD1016802 | 50Vdc       | 100pF+20%-20%             | -             | 30mA |     |     |        |     |      | ReFlow |
|                                              |                  |                | 0.5           | NFR21GD1011012 | 50Vdc       | 100pF+20%-20%             | -             | 25mA |     |     |        |     |      | ReFlow |
| RC Combined Array Type for Signal Lines      | p137             | 1206           | 0.8           | NFA31GD1006R84 | 6Vdc        | 10pF+20%-20%              | -             | 50mA |     |     |        |     |      | ReFlow |
|                                              |                  |                | 0.8           | NFA31GD1004704 | 6Vdc        | 10pF+20%-20%              | -             | 20mA |     |     |        |     |      | ReFlow |
|                                              |                  |                | 0.8           | NFA31GD1001014 | 6Vdc        | 10pF+20%-20%              | -             | 15mA |     |     |        |     |      | ReFlow |
|                                              |                  |                | 0.8           | NFA31GD4706R84 | 6Vdc        | 47pF+20%-20%              | -             | 50mA |     |     |        |     |      | ReFlow |
|                                              |                  |                | 0.8           | NFA31GD4703304 | 6Vdc        | 47pF+20%-20%              | -             | 20mA |     |     |        |     |      | ReFlow |
|                                              |                  |                | 0.8           | NFA31GD4704704 | 6Vdc        | 47pF+20%-20%              | -             | 20mA |     |     |        |     |      | ReFlow |
|                                              |                  |                | 0.8           | NFA31GD4701014 | 6Vdc        | 47pF+20%-20%              | -             | 15mA |     |     |        |     |      | ReFlow |
|                                              |                  |                | 0.8           | NFA31GD1016R84 | 6Vdc        | 100pF+20%-20%             | -             | 50mA |     |     |        |     |      | ReFlow |
|                                              |                  |                | 0.8           | NFA31GD1014704 | 6Vdc        | 100pF+20%-20%             | -             | 20mA |     |     |        |     |      | ReFlow |
| 0.8                                          | NFA31GD1011014   | 6Vdc           | 100pF+20%-20% | -              | 15mA        |                           |               |      |     |     | ReFlow |     |      |        |

△Note • Please read rating and △CAUTION (for storage, operating, rating, soldering, mounting and handling) in this catalog to prevent smoking and/or burning, etc.  
 • This catalog has only typical specifications because there is no space for detailed specifications. Therefore, please review our product specifications or consult the approval sheet for product specifications before ordering.

# NFE31P Series (1206 Size)



Meet 6A, T-type filter with built-in ferrite bead.

Chip Ferrite Bead

### ■ Dimensions

■: Electrode  
(in mm)

### ■ Equivalent Circuit

No polarity.

### ■ Packaging

| Code | Packaging                | Minimum Quantity |
|------|--------------------------|------------------|
| L    | 180mm Reel Embossed Tape | 2000             |
| K    | 330mm Reel Embossed Tape | 8000             |
| B    | Bulk(Bag)                | 500              |

Refer to pages from p.139 to p.144 for mounting information.

### ■ Rated Value (□: packaging code)

| Part Number     | Capacitance    | Rated Current | Rated Voltage | Insulation Resistance (min.) | Operating Temperature Range |         |
|-----------------|----------------|---------------|---------------|------------------------------|-----------------------------|---------|
| NFE31PT220R1E9□ | 22pF+30%-30%   | 6A            | 25Vdc         | 1000M ohm                    | -40°C to +85°C              | ≥3A     |
| NFE31PT470C1E9□ | 47pF+50%-20%   | 6A            | 25Vdc         | 1000M ohm                    | -40°C to +85°C              | ≥3A     |
| NFE31PT101C1E9□ | 100pF+80%-20%  | 6A            | 25Vdc         | 1000M ohm                    | -40°C to +85°C              | ≥3A     |
| NFE31PT221D1E9□ | 220pF+50%-20%  | 6A            | 25Vdc         | 1000M ohm                    | -40°C to +85°C              | ≥3A     |
| NFE31PT471F1E9□ | 470pF+50%-20%  | 6A            | 25Vdc         | 1000M ohm                    | -40°C to +85°C              | ≥3A     |
| NFE31PT152Z1E9□ | 1500pF+50%-20% | 6A            | 25Vdc         | 1000M ohm                    | -40°C to +85°C              | Kit ≥3A |
| NFE31PT222Z1E9□ | 2200pF+50%-50% | 6A            | 25Vdc         | 1000M ohm                    | -40°C to +85°C              | Kit ≥3A |

Number of Circuit: 1

### ■ Insertion Loss Characteristics (Main Items)

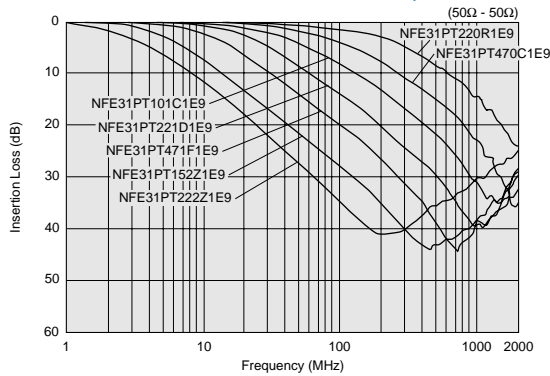

Chip Common Mode Choke Coil

Block Type EMIFIL®

△Note • Please read rating and △CAUTION (for storage, operating, rating, soldering, mounting and handling) in this catalog to prevent smoking and/or burning, etc.  
 • This catalog has only typical specifications because there is no space for detailed specifications. Therefore, please review our product specifications or consult the approval sheet for product specifications before ordering.

# NFE61P Series (2706 Size)



T-type filter with built-in ferrite bead.



### ■ Dimensions

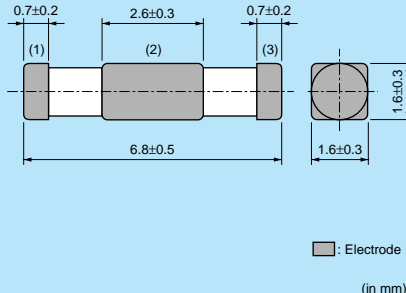

(in mm)

### ■ Equivalent Circuit

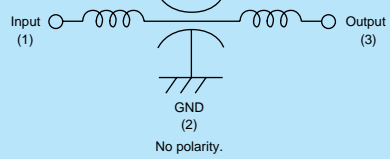

### ■ Packaging

| Code | Packaging                | Minimum Quantity |
|------|--------------------------|------------------|
| L    | 180mm Reel Embossed Tape | 2500             |
| K    | 330mm Reel Embossed Tape | 8000             |
| B    | Bulk(Bag)                | 500              |

Refer to pages from p.139 to p.144 for mounting information.

### ■ Rated Value (□: packaging code)

| Part Number     | Capacitance    | Rated Current | Rated Voltage | Insulation Resistance (min.) | Operating Temperature Range |         |
|-----------------|----------------|---------------|---------------|------------------------------|-----------------------------|---------|
| NFE61PT330B1H9□ | 33pF+30%-30%   | 2A            | 50Vdc         | 1000M ohm                    | -25°C to +85°C              | ≥1A     |
| NFE61PT680B1H9□ | 68pF+30%-30%   | 2A            | 50Vdc         | 1000M ohm                    | -25°C to +85°C              | ≥1A     |
| NFE61PT101Z1H9□ | 100pF+30%-30%  | 2A            | 50Vdc         | 1000M ohm                    | -25°C to +85°C              | ≥1A     |
| NFE61PT181B1H9□ | 180pF+30%-30%  | 2A            | 50Vdc         | 1000M ohm                    | -25°C to +85°C              | ≥1A     |
| NFE61PT361B1H9□ | 360pF+20%-20%  | 2A            | 50Vdc         | 1000M ohm                    | -25°C to +85°C              | ≥1A     |
| NFE61PT681B1H9□ | 680pF+30%-30%  | 2A            | 50Vdc         | 1000M ohm                    | -25°C to +85°C              | ≥1A     |
| NFE61PT102E1H9□ | 1000pF+80%-20% | 2A            | 50Vdc         | 1000M ohm                    | -25°C to +85°C              | Kit ≥1A |
| NFE61PT472C1H9□ | 4700pF+80%-20% | 2A            | 50Vdc         | 1000M ohm                    | -25°C to +85°C              | Kit ≥1A |

Number of Circuit: 1

### ■ Insertion Loss Characteristics (Main Items)

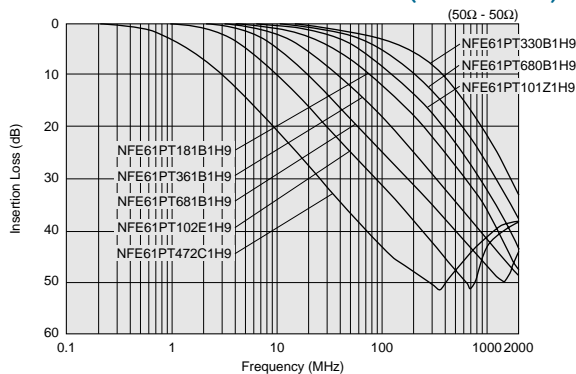

△Note • Please read rating and △CAUTION (for storage, operating, rating, soldering, mounting and handling) in this catalog to prevent smoking and/or burning, etc.  
 • This catalog has only typical specifications because there is no space for detailed specifications. Therefore, please review our product specifications or consult the approval sheet for product specifications before ordering.

# NFM18PS Series (0603 Size)



3-terminal capacitor for power lines whose ground impedance has reduced.

\*Please refer to the products which are designed for both power lines and signal lines.

### ■ Dimensions

(in mm)

### ■ Equivalent Circuit

No polarity.

### ■ Packaging

| Code | Packaging             | Minimum Quantity |
|------|-----------------------|------------------|
| D    | 180mm Reel Paper Tape | 4000             |
| B    | Bulk(Bag)             | 500              |

Refer to pages from p.139 to p.144 for mounting information.

### ■ Rated Value (□: packaging code)

| Part Number     | Capacitance    | Rated Current | Rated Voltage | Insulation Resistance (min.) | Operating Temperature Range |               |
|-----------------|----------------|---------------|---------------|------------------------------|-----------------------------|---------------|
| NFM18PS474R0J3□ | 0.47μF+20%-20% | 2A            | 6.3Vdc        | 1000M ohm                    | -55°C to +125°C             | Kit $\geq 1A$ |
| NFM18PS105R0J3□ | 1.0μF+20%-20%  | 2A            | 6.3Vdc        | 500M ohm                     | -55°C to +105°C             | Kit $\geq 1A$ |

Number of Circuit: 1

### ■ Insertion Loss Characteristics (Main Items)

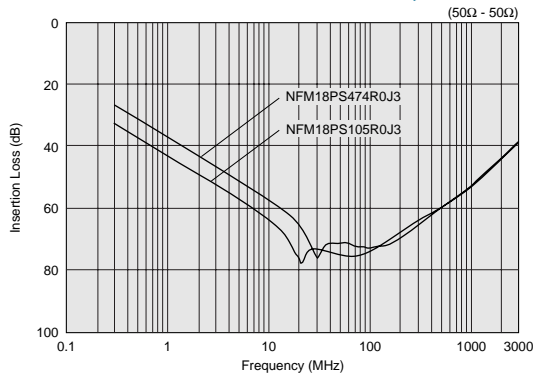

△Note • Please read rating and △CAUTION (for storage, operating, rating, soldering, mounting and handling) in this catalog to prevent smoking and/or burning, etc.  
 • This catalog has only typical specifications because there is no space for detailed specifications. Therefore, please review our product specifications or consult the approval sheet for product specifications before ordering.

Chip Ferrite Bead  
Chip EMIFIL® Power Lines Type  
Chip Common Mode Choke Coil  
Block Type EMIFIL®

# NFM18PC Series (0603 Size)



## 4A max, 0603 size chip 3-terminal capacitor for power lines.

\*Please refer to the products which are designed for both power lines and signal lines.

**NFM18PC (0.1 to 0.47μF, 2.2μF-6.3V)**

**■ Dimensions**

(in mm)

**■ Equivalent Circuit**

No polarity.

**■ Packaging**

| Code | Packaging             | Minimum Quantity |
|------|-----------------------|------------------|
| D    | 180mm Reel Paper Tape | 4000             |
| B    | Bulk(Bag)             | 500              |

**NFM18PC (1μF, 2.2μF-10V)**

**■ Dimensions**

(in mm)

**■ Equivalent Circuit**

No polarity.

**■ Packaging**

| Code | Packaging             | Minimum Quantity |
|------|-----------------------|------------------|
| D    | 180mm Reel Paper Tape | 4000             |
| B    | Bulk(Bag)             | 500              |

Refer to pages from p.139 to p.144 for mounting information.

**■ Rated Value (□: packaging code)**

| Part Number     | Capacitance | Rated Current | Rated Voltage | Insulation Resistance (min.) | Operating Temperature Range |         |
|-----------------|-------------|---------------|---------------|------------------------------|-----------------------------|---------|
| NFM18PC104R1C3□ | 0.1μF±20%   | 2A            | 16Vdc         | 1000M ohm                    | -55°C to +125°C             | Kit ≥1A |
| NFM18PC224R0J3□ | 0.22μF±20%  | 2A            | 6.3Vdc        | 1000M ohm                    | -55°C to +125°C             | Kit ≥1A |
| NFM18PC474R0J3□ | 0.47μF±20%  | 2A            | 6.3Vdc        | 1000M ohm                    | -55°C to +125°C             | Kit ≥1A |
| NFM18PC105R0J3□ | 1.0μF±20%   | 4A            | 6.3Vdc        | 500M ohm                     | -55°C to +105°C             | Kit ≥1A |
| NFM18PC225B0J3□ | 2.2μF±20%   | 2A            | 6.3Vdc        | 200M ohm                     | -40°C to +85°C              | Kit ≥1A |
| NFM18PC225B1A3□ | 2.2μF±20%   | 4A            | 10Vdc         | 200M ohm                     | -40°C to +85°C              | Kit ≥3A |

Number of Circuit: 1

**■ Insertion Loss Characteristics (Main Items)**

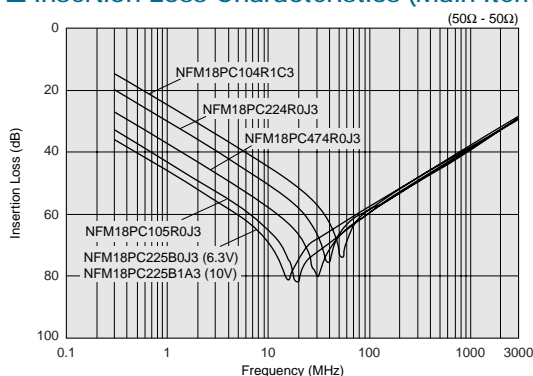

△Note • Please read rating and △CAUTION (for storage, operating, rating, soldering, mounting and handling) in this catalog to prevent smoking and/or burning, etc.  
 • This catalog has only typical specifications because there is no space for detailed specifications. Therefore, please review our product specifications or consult the approval sheet for product specifications before ordering.

• High frequency performance of NFM18PS series

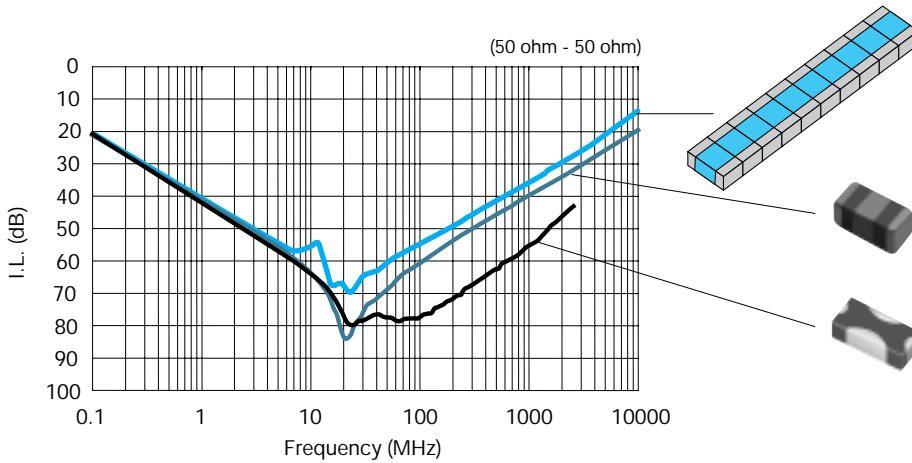

Chip 3 terminal capacitor

2 terminal MLCC: 2012 size  
(0.1μF x 10pcs parallel)

NFM18PC105R0J3 1pc  
: 1608 size (1.0μF)

NFM18PS105R0J3 1pc  
: 1608 size (1.0μF)

NFM18PS series has better high frequency performance compared to normal chip 3 terminal capacitors.

• Optimize of bypass capacitors using chip 3 terminal capacitor

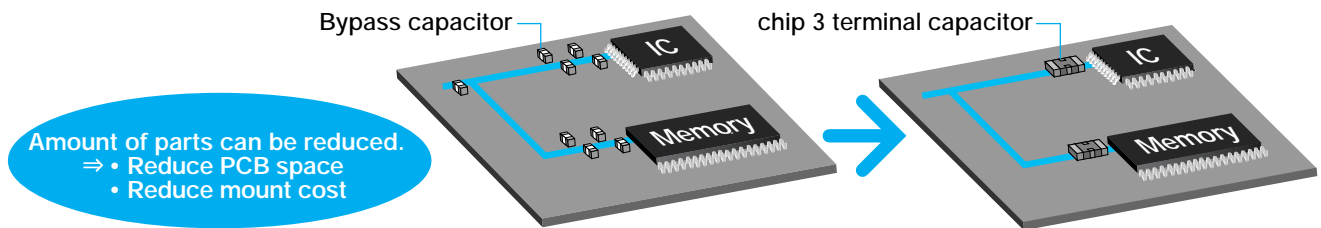

Comparison of performance as bypass capacitor

Without capacitor

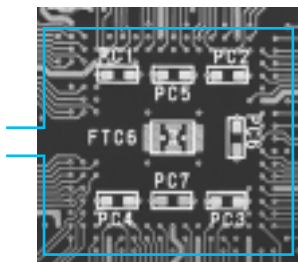

Micro computer

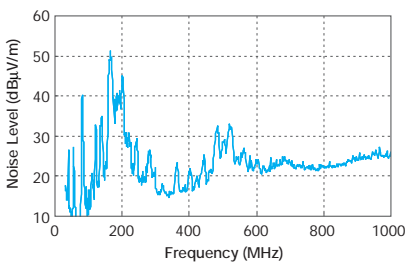
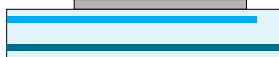

With MLCC 0.22μF x 4

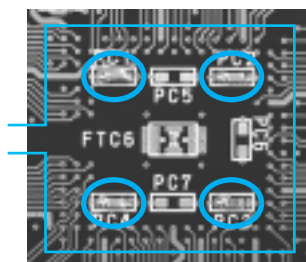

Micro computer

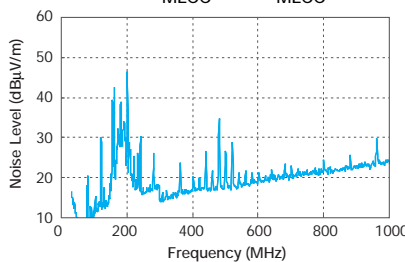
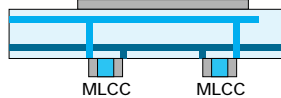

With chip 3 terminal capacitor (NFM) 1μF x 1

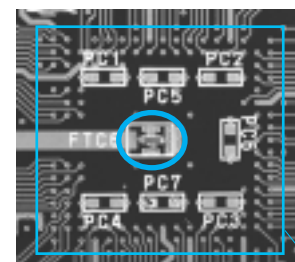

Micro computer

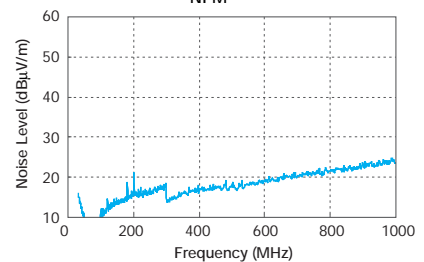
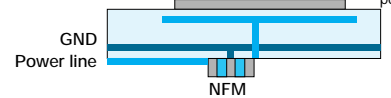

Noise suppression effect of NFM series is better than MLCCs. (1 NFM is better than 4 MLCCs)

△Note • Please read rating and △CAUTION (for storage, operating, rating, soldering, mounting and handling) in this catalog to prevent smoking and/or burning, etc.  
• This catalog has only typical specifications because there is no space for detailed specifications. Therefore, please review our product specifications or consult the approval sheet for product specifications before ordering.

# NFM21P Series (0805 Size)



## 6A max, 0805 size chip 3-terminal capacitor for power lines.

\*Please refer to the products which are designed for both power lines and signal lines.

### ■ Dimensions

(in mm)

### ■ Equivalent Circuit

### ■ Packaging

| Code | Packaging             | Minimum Quantity |
|------|-----------------------|------------------|
| D    | 180mm Reel Paper Tape | 4000             |
| B    | Bulk(Bag)             | 500              |

Refer to pages from p.139 to p.144 for mounting information.

### ■ Rated Value (□: packaging code)

| Part Number     | Capacitance    | Rated Current | Rated Voltage | Insulation Resistance (min.) | Operating Temperature Range |         |
|-----------------|----------------|---------------|---------------|------------------------------|-----------------------------|---------|
| NFM21PC104R1E3□ | 0.1μF+20%-20%  | 2A            | 25Vdc         | 1000M ohm                    | -55°C to +125°C             | Kit ≥1A |
| NFM21PC224R1C3□ | 0.22μF+20%-20% | 2A            | 16Vdc         | 1000M ohm                    | -55°C to +125°C             | Kit ≥1A |
| NFM21PC474R1C3□ | 0.47μF+20%-20% | 2A            | 16Vdc         | 1000M ohm                    | -55°C to +125°C             | Kit ≥1A |
| NFM21PC105B1A3□ | 1.0μF+20%-20%  | 4A            | 10Vdc         | 500M ohm                     | -40°C to +85°C              | Kit ≥3A |
| NFM21PC105B1C3□ | 1.0μF+20%-20%  | 4A            | 16Vdc         | 500M ohm                     | -40°C to +85°C              | Kit ≥3A |
| NFM21PC225B0J3□ | 2.2μF+20%-20%  | 4A            | 6.3Vdc        | 200M ohm                     | -40°C to +85°C              | Kit ≥3A |
| NFM21PC475B1A3□ | 4.7μF+20%-20%  | 6A            | 10Vdc         | 100M ohm                     | -40°C to +85°C              | Kit ≥3A |

Number of Circuit: 1

### ■ Insertion Loss Characteristics (Main Items)

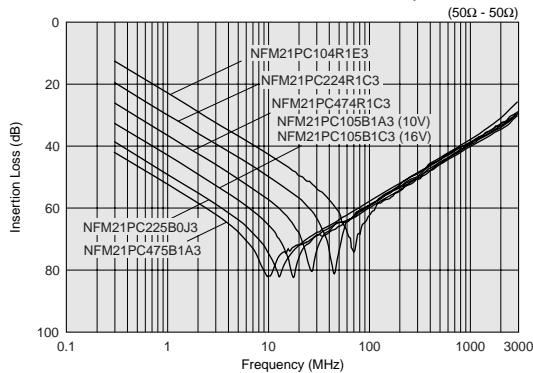

△Note • Please read rating and △CAUTION (for storage, operating, rating, soldering, mounting and handling) in this catalog to prevent smoking and/or burning, etc.  
 • This catalog has only typical specifications because there is no space for detailed specifications. Therefore, please review our product specifications or consult the approval sheet for product specifications before ordering.

Chip Ferrite Bead  
Power Lines Type Chip EMIFIL®  
Chip Common Mode Choke Coil  
Block Type EMIFIL®



# NFM3DP Series (1205 Size)



## 1205 size 3-terminal capacitor for power lines.

\*Please refer to the products which are designed for both power lines and signal lines.

### ■ Dimensions

Legend:  : Electrode (in mm)

### ■ Equivalent Circuit

No polarity.

### ■ Packaging

| Code | Packaging                | Minimum Quantity |
|------|--------------------------|------------------|
| L    | 180mm Reel Embossed Tape | 4000             |
| B    | Bulk(Bag)                | 500              |

Refer to pages from p.139 to p.144 for mounting information.

### ■ Rated Value (□: packaging code)

| Part Number     | Capacitance     | Rated Current | Rated Voltage | Insulation Resistance (min.) | Operating Temperature Range |     |
|-----------------|-----------------|---------------|---------------|------------------------------|-----------------------------|-----|
| NFM3DPC223R1H3□ | 0.022μF+20%-20% | 2A            | 50Vdc         | 1000M ohm                    | -55°C to +125°C             | ≥1A |

Number of Circuit: 1

### ■ Insertion Loss Characteristics (Main Items)

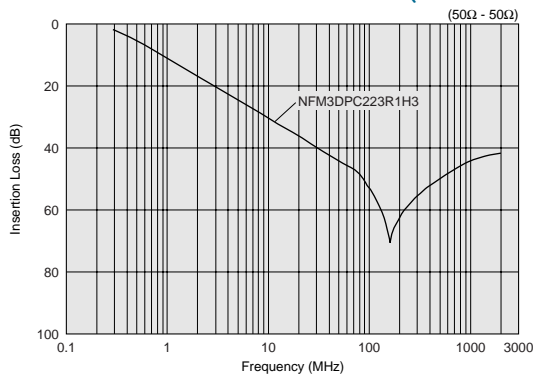

### ■ Notice (Rating)

When NFM3DP series is used in operating temperatures exceeding +85°C, derating of current is necessary. Please apply the derating curve shown in chart according to the operating temperature.

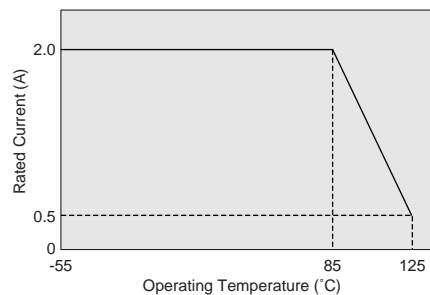

△Note • Please read rating and △CAUTION (for storage, operating, rating, soldering, mounting and handling) in this catalog to prevent smoking and/or burning, etc.  
 • This catalog has only typical specifications because there is no space for detailed specifications. Therefore, please review our product specifications or consult the approval sheet for product specifications before ordering.

Chip Ferrite Bead  
Chip EMIFIL® Power Lines Type  
Chip Common Mode Choke Coil  
Block Type EMIFIL®

# NFM31P Series (1206 Size)



6A/27microF, 1206 size chip 3-terminal capacitor for power lines.

\*Please refer to the products which are designed for both power lines and signal lines.

### ■ Dimensions

(in mm)

### ■ Equivalent Circuit

No polarity.

### ■ Packaging

| Code | Packaging                | Minimum Quantity |
|------|--------------------------|------------------|
| L    | 180mm Reel Embossed Tape | 3000             |
| B    | Bulk(Bag)                | 500              |

Refer to pages from p.139 to p.144 for mounting information.

### ■ Rated Value (□: packaging code)

| Part Number     | Capacitance  | Rated Current | Rated Voltage | Insulation Resistance (min.) | Operating Temperature Range |               |
|-----------------|--------------|---------------|---------------|------------------------------|-----------------------------|---------------|
| NFM31PC276B0J3□ | 27μF+20%-20% | 6A            | 6.3Vdc        | 20M ohm                      | -40°C to +85°C              | Kit $\geq 3A$ |

Number of Circuit: 1

### ■ Insertion Loss Characteristics (Main Items)

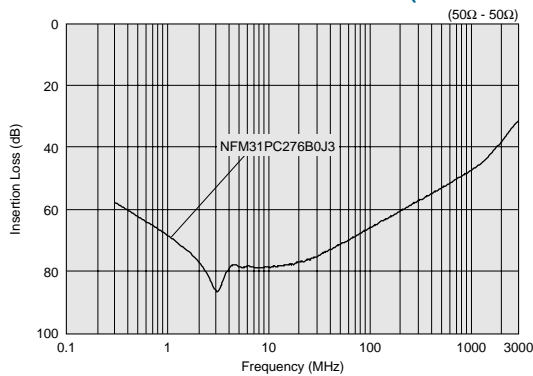

△Note • Please read rating and △CAUTION (for storage, operating, rating, soldering, mounting and handling) in this catalog to prevent smoking and/or burning, etc.  
 • This catalog has only typical specifications because there is no space for detailed specifications. Therefore, please review our product specifications or consult the approval sheet for product specifications before ordering.

# NFM41P Series (1806 Size)



## 6A max, 1806 size chip 3-terminal capacitor for power lines.

\*Please refer to the products which are designed for both power lines and signal lines.



### ■ Dimensions

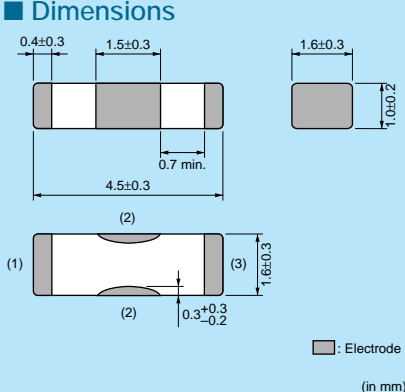

(in mm)

### ■ Equivalent Circuit

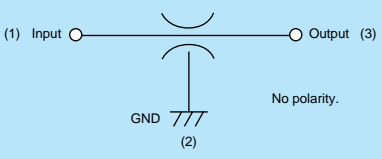

No polarity.

### ■ Packaging

| Code | Packaging                | Minimum Quantity |
|------|--------------------------|------------------|
| L    | 180mm Reel Embossed Tape | 4000             |
| B    | Bulk(Bag)                | 500              |

Refer to pages from p.139 to p.144 for mounting information.

### ■ Rated Value (□: packaging code)

| Part Number     | Capacitance   | Rated Current | Rated Voltage | Insulation Resistance (min.) | Operating Temperature Range |         |
|-----------------|---------------|---------------|---------------|------------------------------|-----------------------------|---------|
| NFM41PC204F1H3□ | 0.2μF+80%-20% | 2A            | 50Vdc         | 1000M ohm                    | -55°C to +85°C              | Kit ≥1A |
| NFM41PC155B1E3□ | 1.5μF+20%-20% | 6A            | 25Vdc         | 300M ohm                     | -55°C to +85°C              | Kit ≥3A |

Number of Circuit: 1

### ■ Insertion Loss Characteristics (Main Items)

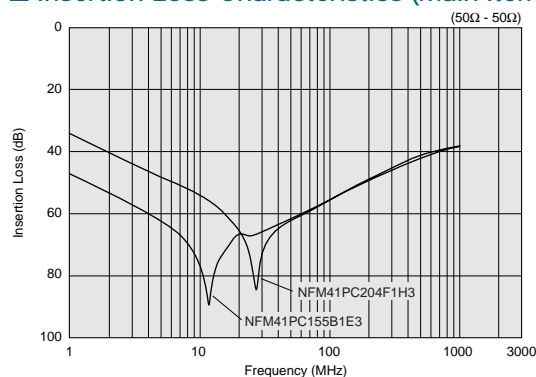

△Note • Please read rating and △CAUTION (for storage, operating, rating, soldering, mounting and handling) in this catalog to prevent smoking and/or burning, etc.  
 • This catalog has only typical specifications because there is no space for detailed specifications. Therefore, please review our product specifications or consult the approval sheet for product specifications before ordering.

# NFM55P Series (2220 Size)



## 50V/6A/1.5microF, large capacitance chip 3-terminal capacitor.

\*Please refer to the products which are designed for both power lines and signal lines.

### ■ Dimensions

■ Electrode (in mm)

### ■ Equivalent Circuit

No polarity.

### ■ Packaging

| Code | Packaging                | Minimum Quantity |
|------|--------------------------|------------------|
| L    | 180mm Reel Embossed Tape | 500              |
| B    | Bulk(Bag)                | 100              |

Refer to pages from p.139 to p.144 for mounting information.

### ■ Rated Value (□: packaging code)

| Part Number     | Capacitance   | Rated Current | Rated Voltage | Insulation Resistance (min.) | Operating Temperature Range |     |
|-----------------|---------------|---------------|---------------|------------------------------|-----------------------------|-----|
| NFM55PC155F1H4□ | 1.5μF+80%-20% | 6A            | 50Vdc         | 100M ohm                     | -55°C to +85°C              | ≥3A |

Number of Circuit: 1

### ■ Insertion Loss Characteristics (Main Items)

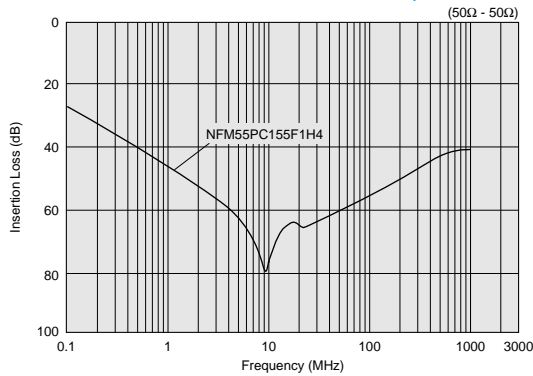

△Note • Please read rating and △CAUTION (for storage, operating, rating, soldering, mounting and handling) in this catalog to prevent smoking and/or burning, etc.  
 • This catalog has only typical specifications because there is no space for detailed specifications. Therefore, please review our product specifications or consult the approval sheet for product specifications before ordering.

# NFM18C Series (0603 Size)



0603 size general 3-terminal capacitor.



### ■ Dimensions

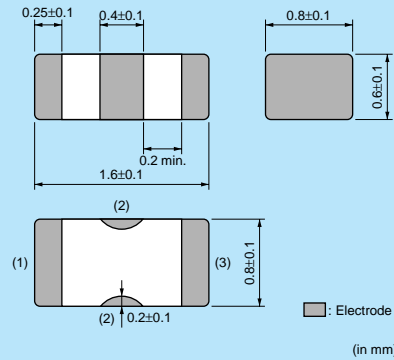

### ■ Equivalent Circuit

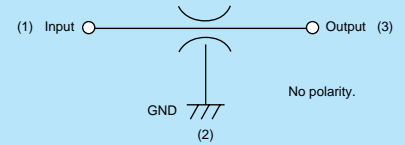

### ■ Packaging

| Code | Packaging             | Minimum Quantity |
|------|-----------------------|------------------|
| D    | 180mm Reel Paper Tape | 4000             |
| B    | Bulk(Bag)             | 500              |

Refer to pages from p.139 to p.144 for mounting information.

### ■ Rated Value (□: packaging code)

| Part Number     | Capacitance     | Rated Current | Rated Voltage | Insulation Resistance (min.) | Operating Temperature Range |               |
|-----------------|-----------------|---------------|---------------|------------------------------|-----------------------------|---------------|
| NFM18CC220U1C3□ | 22pF+20%-20%    | 400mA         | 16Vdc         | 1000M ohm                    | -55°C to +125°C             | Kit           |
| NFM18CC470U1C3□ | 47pF+20%-20%    | 400mA         | 16Vdc         | 1000M ohm                    | -55°C to +125°C             | Kit           |
| NFM18CC101R1C3□ | 100pF+20%-20%   | 500mA         | 16Vdc         | 1000M ohm                    | -55°C to +125°C             | Kit           |
| NFM18CC221R1C3□ | 220pF+20%-20%   | 500mA         | 16Vdc         | 1000M ohm                    | -55°C to +125°C             | Kit           |
| NFM18CC471R1C3□ | 470pF+20%-20%   | 500mA         | 16Vdc         | 1000M ohm                    | -55°C to +125°C             | Kit           |
| NFM18CC102R1C3□ | 1000pF+20%-20%  | 600mA         | 16Vdc         | 1000M ohm                    | -55°C to +125°C             | Kit           |
| NFM18CC222R1C3□ | 2200pF+20%-20%  | 700mA         | 16Vdc         | 1000M ohm                    | -55°C to +125°C             | Kit           |
| NFM18CC223R1C3□ | 22000pF+20%-20% | 1000mA        | 16Vdc         | 1000M ohm                    | -55°C to +125°C             | Kit $\geq 1A$ |

Number of Circuit: 1

### ■ Insertion Loss Characteristics (Main Items)

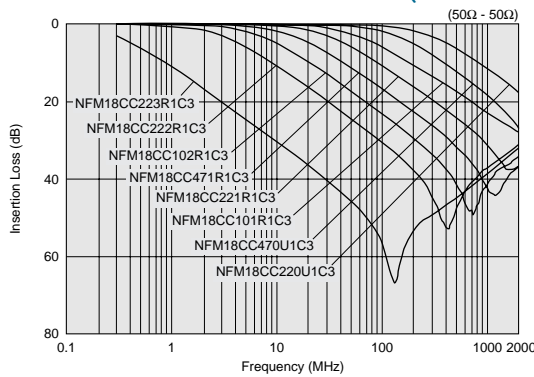

△Note • Please read rating and △CAUTION (for storage, operating, rating, soldering, mounting and handling) in this catalog to prevent smoking and/or burning, etc.  
 • This catalog has only typical specifications because there is no space for detailed specifications. Therefore, please review our product specifications or consult the approval sheet for product specifications before ordering.

# NFM21C Series (0805 Size)



0805 size general 3-terminal capacitor.

### ■ Dimensions

0.3±0.2  
0.6±0.2  
2.0±0.2  
0.85±0.1  
1.25±0.1  
0.2±0.2  
0.1±0.1

Legend:  Electrode (in mm)

### ■ Equivalent Circuit

(1) Input ———— Output (3)  
GND (2)  
No polarity.

### ■ Packaging

| Code | Packaging             | Minimum Quantity |
|------|-----------------------|------------------|
| D    | 180mm Reel Paper Tape | 4000             |
| B    | Bulk(Bag)             | 500              |

Refer to pages from p.139 to p.144 for mounting information.

### ■ Rated Value (□: packaging code)

| Part Number     | Capacitance     | Rated Current | Rated Voltage | Insulation Resistance (min.) | Operating Temperature Range |         |
|-----------------|-----------------|---------------|---------------|------------------------------|-----------------------------|---------|
| NFM21CC220U1H3□ | 22pF+20%-20%    | 700mA         | 50Vdc         | 1000M ohm                    | -55°C to +125°C             | Kit     |
| NFM21CC470U1H3□ | 47pF+20%-20%    | 700mA         | 50Vdc         | 1000M ohm                    | -55°C to +125°C             | Kit     |
| NFM21CC101U1H3□ | 100pF+20%-20%   | 700mA         | 50Vdc         | 1000M ohm                    | -55°C to +125°C             | Kit     |
| NFM21CC221R1H3□ | 220pF+20%-20%   | 700mA         | 50Vdc         | 1000M ohm                    | -55°C to +125°C             | Kit     |
| NFM21CC471R1H3□ | 470pF+20%-20%   | 1000mA        | 50Vdc         | 1000M ohm                    | -55°C to +125°C             | Kit ≥1A |
| NFM21CC102R1H3□ | 1000pF+20%-20%  | 1000mA        | 50Vdc         | 1000M ohm                    | -55°C to +125°C             | Kit ≥1A |
| NFM21CC222R1H3□ | 2200pF+20%-20%  | 1000mA        | 50Vdc         | 1000M ohm                    | -55°C to +125°C             | Kit ≥1A |
| NFM21CC223R1H3□ | 22000pF+20%-20% | 2000mA        | 50Vdc         | 1000M ohm                    | -55°C to +125°C             | Kit ≥1A |

Number of Circuit: 1

### ■ Insertion Loss Characteristics (Main Items)

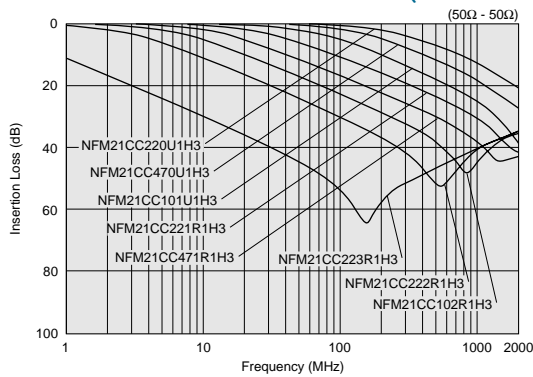

△Note • Please read rating and △CAUTION (for storage, operating, rating, soldering, mounting and handling) in this catalog to prevent smoking and/or burning, etc.  
• This catalog has only typical specifications because there is no space for detailed specifications. Therefore, please review our product specifications or consult the approval sheet for product specifications before ordering.

# NFM3DC Series (1205 Size)



1205 size general 3-terminal capacitor.



### ■ Dimensions

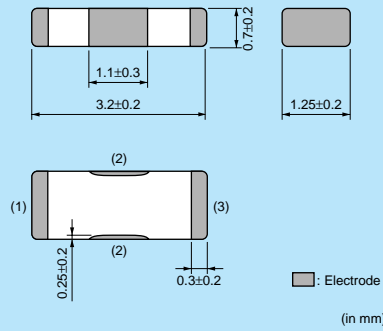

### ■ Equivalent Circuit

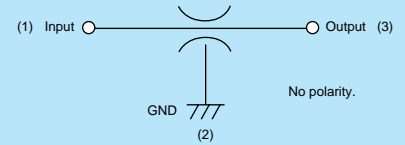

### ■ Packaging

| Code | Packaging                | Minimum Quantity |
|------|--------------------------|------------------|
| L    | 180mm Reel Embossed Tape | 4000             |
| B    | Bulk(Bag)                | 500              |

Refer to pages from p.139 to p.144 for mounting information.

### ■ Rated Value (□: packaging code)

| Part Number     | Capacitance     | Rated Current | Rated Voltage | Insulation Resistance (min.) | Operating Temperature Range |
|-----------------|-----------------|---------------|---------------|------------------------------|-----------------------------|
| NFM3DCC220U1H3□ | 22pF+50%-20%    | 300mA         | 50Vdc         | 1000M ohm                    | -55°C to +125°C             |
| NFM3DCC470U1H3□ | 47pF+50%-20%    | 300mA         | 50Vdc         | 1000M ohm                    | -55°C to +125°C             |
| NFM3DCC101U1H3□ | 100pF+50%-20%   | 300mA         | 50Vdc         | 1000M ohm                    | -55°C to +125°C             |
| NFM3DCC221R1H3□ | 220pF+50%-20%   | 300mA         | 50Vdc         | 1000M ohm                    | -55°C to +125°C             |
| NFM3DCC471R1H3□ | 470pF+50%-20%   | 300mA         | 50Vdc         | 1000M ohm                    | -55°C to +125°C             |
| NFM3DCC102R1H3□ | 1000pF+50%-20%  | 300mA         | 50Vdc         | 1000M ohm                    | -55°C to +125°C             |
| NFM3DCC222R1H3□ | 2200pF+50%-20%  | 300mA         | 50Vdc         | 1000M ohm                    | -55°C to +125°C             |
| NFM3DCC223R1H3□ | 22000pF+50%-20% | 300mA         | 50Vdc         | 1000M ohm                    | -55°C to +125°C             |

Number of Circuit: 1

### ■ Insertion Loss Characteristics (Main Items)

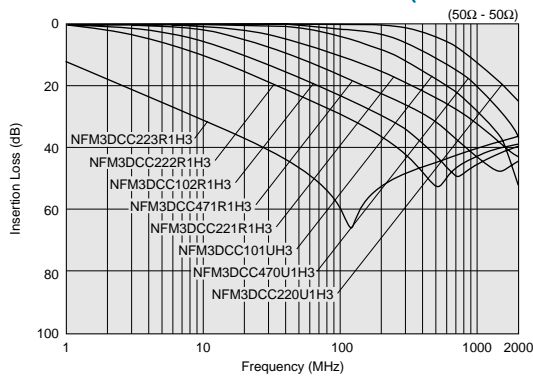

△Note • Please read rating and △CAUTION (for storage, operating, rating, soldering, mounting and handling) in this catalog to prevent smoking and/or burning, etc.  
 • This catalog has only typical specifications because there is no space for detailed specifications. Therefore, please review our product specifications or consult the approval sheet for product specifications before ordering.

# NFM41C Series (1806 Size)



1806 size general 3-terminal capacitor.

### ■ Dimensions

(in mm)

### ■ Equivalent Circuit

No polarity.

### ■ Packaging

| Code | Packaging                | Minimum Quantity |
|------|--------------------------|------------------|
| L    | 180mm Reel Embossed Tape | 4000             |
| B    | Bulk(Bag)                | 500              |

Refer to pages from p.139 to p.144 for mounting information.

### ■ Rated Value (□: packaging code)

| Part Number     | Capacitance     | Rated Current | Rated Voltage | Insulation Resistance (min.) | Operating Temperature Range |
|-----------------|-----------------|---------------|---------------|------------------------------|-----------------------------|
| NFM41CC220U2A3□ | 22pF+50%-20%    | 300mA         | 100Vdc        | 10000M ohm                   | -55°C to +125°C             |
| NFM41CC470U2A3□ | 47pF+50%-20%    | 300mA         | 100Vdc        | 10000M ohm                   | -55°C to +125°C             |
| NFM41CC101U2A3□ | 100pF+50%-20%   | 300mA         | 100Vdc        | 10000M ohm                   | -55°C to +125°C             |
| NFM41CC221U2A3□ | 220pF+50%-20%   | 300mA         | 100Vdc        | 10000M ohm                   | -55°C to +125°C             |
| NFM41CC471R2A3□ | 470pF+50%-20%   | 300mA         | 100Vdc        | 10000M ohm                   | -55°C to +125°C             |
| NFM41CC102R2A3□ | 1000pF+50%-20%  | 300mA         | 100Vdc        | 10000M ohm                   | -55°C to +125°C             |
| NFM41CC222R2A3□ | 2200pF+50%-20%  | 300mA         | 100Vdc        | 10000M ohm                   | -55°C to +125°C             |
| NFM41CC223R2A3□ | 22000pF+50%-20% | 300mA         | 100Vdc        | 10000M ohm                   | -55°C to +125°C             |

Number of Circuit: 1

### ■ Insertion Loss Characteristics (Main Items)

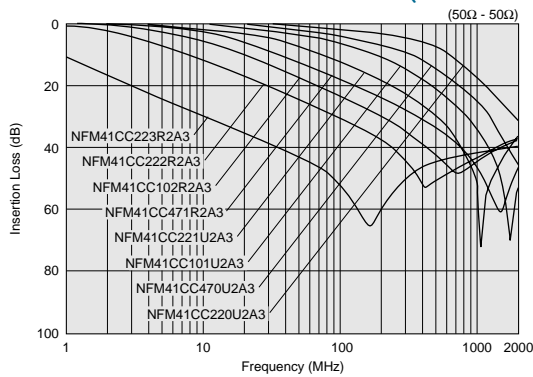

△Note • Please read rating and △CAUTION (for storage, operating, rating, soldering, mounting and handling) in this catalog to prevent smoking and/or burning, etc.  
 • This catalog has only typical specifications because there is no space for detailed specifications. Therefore, please review our product specifications or consult the approval sheet for product specifications before ordering.



# NFA31C Series (1206 Size)



4-lines chip 3-terminal capacitor array, 1206 size.

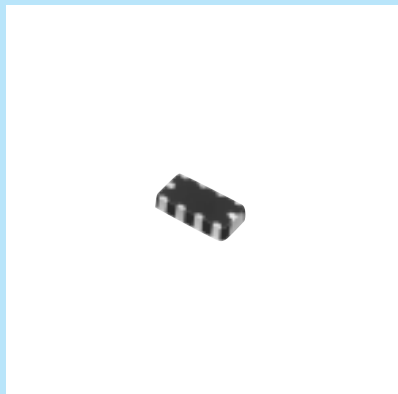

### ■ Dimensions

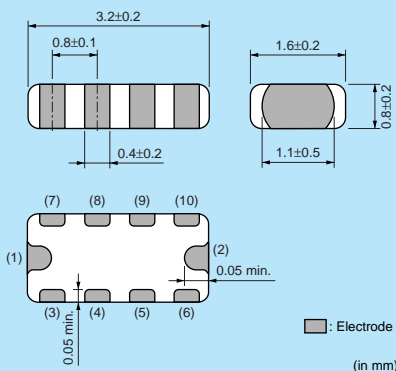

### ■ Equivalent Circuit

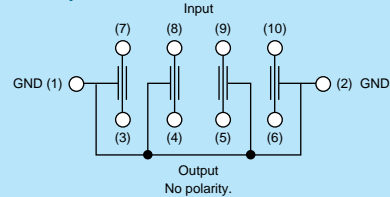

### ■ Packaging

| Code | Packaging             | Minimum Quantity |
|------|-----------------------|------------------|
| D    | 180mm Reel Paper Tape | 4000             |
| B    | Bulk(Bag)             | 100              |

Refer to pages from p.139 to p.144 for mounting information.

### ■ Rated Value (□: packaging code)

| Part Number     | Capacitance     | Rated Current | Rated Voltage | Insulation Resistance (min.) | Operating Temperature Range |     |
|-----------------|-----------------|---------------|---------------|------------------------------|-----------------------------|-----|
| NFA31CC220S1E4□ | 22pF+20%-20%    | 200mA         | 25Vdc         | 1000M ohm                    | -40°C to +85°C              | Kit |
| NFA31CC470S1E4□ | 47pF+20%-20%    | 200mA         | 25Vdc         | 1000M ohm                    | -40°C to +85°C              | Kit |
| NFA31CC101S1E4□ | 100pF+20%-20%   | 200mA         | 25Vdc         | 1000M ohm                    | -40°C to +85°C              | Kit |
| NFA31CC221S1E4□ | 220pF+20%-20%   | 200mA         | 25Vdc         | 1000M ohm                    | -40°C to +85°C              | Kit |
| NFA31CC471R1E4□ | 470pF+20%-20%   | 200mA         | 25Vdc         | 1000M ohm                    | -40°C to +85°C              | Kit |
| NFA31CC102R1E4□ | 1000pF+20%-20%  | 200mA         | 25Vdc         | 1000M ohm                    | -40°C to +85°C              | Kit |
| NFA31CC222R1E4□ | 2200pF+20%-20%  | 200mA         | 25Vdc         | 1000M ohm                    | -40°C to +85°C              | Kit |
| NFA31CC223R1C4□ | 22000pF+20%-20% | 200mA         | 16Vdc         | 1000M ohm                    | -40°C to +85°C              | Kit |

Number of Circuit: 4

### ■ Insertion Loss Characteristics (Main Items)

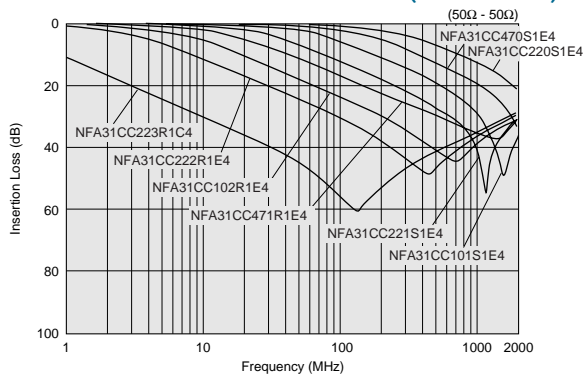

△Note • Please read rating and △CAUTION (for storage, operating, rating, soldering, mounting and handling) in this catalog to prevent smoking and/or burning, etc.  
 • This catalog has only typical specifications because there is no space for detailed specifications. Therefore, please review our product specifications or consult the approval sheet for product specifications before ordering.

# NFL18ST Series (0603 Size)



T-type LC filter. Reduce waveform distortion of high speed signal.



**NFL18ST\_H**

**■ Dimensions**  
(Top View)

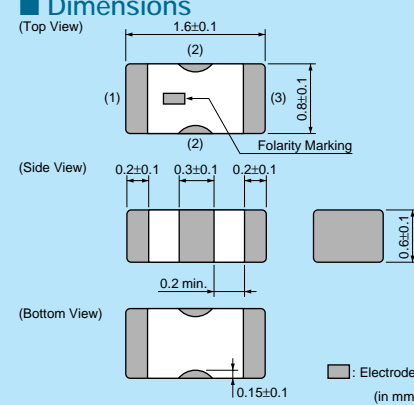

(Side View)

(Bottom View)

Legend:  Electrode (in mm)

**■ Equivalent Circuit**

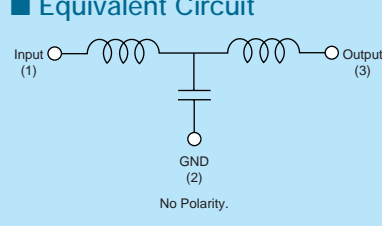

No Polarity.

**■ Packaging**

| Code | Packaging             | Minimum Quantity |
|------|-----------------------|------------------|
| D    | 180mm Reel Paper Tape | 4000             |
| B    | Bulk(Bag)             | 1000             |



**NFL18ST\_X**

**■ Dimensions**

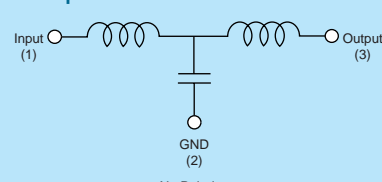

Legend:  Electrode (in mm)

**■ Equivalent Circuit**

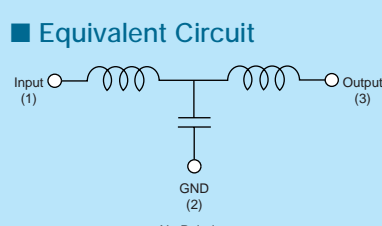

No Polarity.

**■ Packaging**

| Code | Packaging             | Minimum Quantity |
|------|-----------------------|------------------|
| D    | 180mm Reel Paper Tape | 4000             |
| B    | Bulk(Bag)             | 1000             |

Refer to pages from p.139 to p.144 for mounting information.

**■ Rated Value** (□: packaging code)

| Part Number     | Nominal Cut-off Frequency | Capacitance  | Inductance   | Insertion Loss (Cut-off Frequency) | Insertion Loss (200MHz) (min.) | Insertion Loss (300MHz) (min.) | Insertion Loss (400MHz) (min.) | Rated Current | Rated Voltage |             |
|-----------------|---------------------------|--------------|--------------|------------------------------------|--------------------------------|--------------------------------|--------------------------------|---------------|---------------|-------------|
| NFL18ST506H1A3□ | 50MHz                     | 110pF (Typ.) | 350nH (Typ.) | 6dB max.                           | 30dB                           | 30dB                           | 30dB                           | 75mA          | 10Vdc         | New Kit QTV |
| NFL18ST706H1A3□ | 70MHz                     | 70pF (Typ.)  | 230nH (Typ.) | 6dB max.                           | -                              | 30dB                           | 30dB                           | 75mA          | 10Vdc         | New Kit QTV |
| NFL18ST107H1A3□ | 100MHz                    | 50pF (Typ.)  | 150nH (Typ.) | 6dB max.                           | -                              | -                              | 30dB                           | 75mA          | 10Vdc         | New Kit QTV |

Insulation Resistance (min.): 1000M ohm Withstand Voltage: 30Vdc Operating Temperature Range: -55°C to +125°C Number of Circuits: 1

**■ Insertion Loss Characteristics (Main Items)**

**NFL18ST\_H Series**

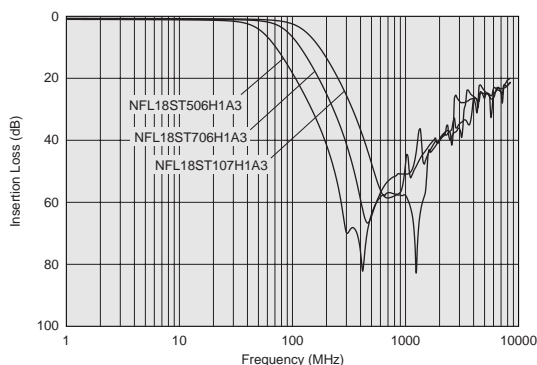

Continued on the following page.

**△Note** • Please read rating and **△CAUTION** (for storage, operating, rating, soldering, mounting and handling) in this catalog to prevent smoking and/or burning, etc.  
• This catalog has only typical specifications because there is no space for detailed specifications. Therefore, please review our product specifications or consult the approval sheet for product specifications before ordering.

■ Rated Value (□: packaging code)

| Part Number     | Nominal Cut-off Frequency | Capacitance | Inductance | Rated Current | Rated Voltage | Insulation Resistance (min.) | Withstand Voltage | Operating Temperature Range |     |
|-----------------|---------------------------|-------------|------------|---------------|---------------|------------------------------|-------------------|-----------------------------|-----|
| NFL18ST207X1C3□ | 200MHz                    | 25pF±20%    | 110nH±20%  | 150mA         | 16Vdc         | 1000M ohm                    | 50Vdc             | -55°C to +125°C             | Kit |
| NFL18ST307X1C3□ | 300MHz                    | 18pF±20%    | 62nH±20%   | 200mA         | 16Vdc         | 1000M ohm                    | 50Vdc             | -55°C to +125°C             | Kit |
| NFL18ST507X1C3□ | 500MHz                    | 10pF±20%    | 43nH±20%   | 200mA         | 16Vdc         | 1000M ohm                    | 50Vdc             | -55°C to +125°C             | Kit |

Number of Circuits: 1

■ Insertion Loss Characteristics (Main Items)

NFL18ST\_X Series

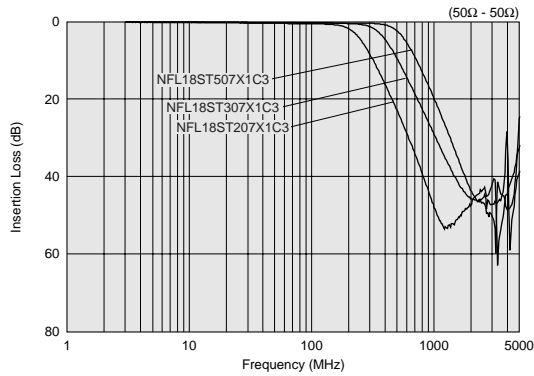

△Note • Please read rating and △CAUTION (for storage, operating, rating, soldering, mounting and handling) in this catalog to prevent smoking and/or burning, etc.  
• This catalog has only typical specifications because there is no space for detailed specifications. Therefore, please review our product specifications or consult the approval sheet for product specifications before ordering.

# NFL18SP Series (0603 Size)



PI-type LC filter. Reduce waveform distortion of high speed signal.

### ■ Dimensions

0.15±0.1  
0.8±0.1  
1.6±0.1  
0.2 min.  
0.3±0.1 0.4±0.1 0.3±0.1  
0.15±0.1 0.15±0.1  
0.6±0.1  
Electrode (in mm)

### ■ Equivalent Circuit

(1) Input (3) Output (3)  
GND (2)  
No polarity.

### ■ Packaging

| Code | Packaging             | Minimum Quantity |
|------|-----------------------|------------------|
| D    | 180mm Reel Paper Tape | 4000             |
| B    | Bulk(Bag)             | 1000             |

Refer to pages from p.139 to p.144 for mounting information.

### ■ Rated Value (□: packaging code)

| Part Number     | Nominal Cut-off Frequency | Capacitance | Inductance | Rated Current | Rated Voltage | Insulation Resistance (min.) | Withstand Voltage | Operating Temperature Range |     |
|-----------------|---------------------------|-------------|------------|---------------|---------------|------------------------------|-------------------|-----------------------------|-----|
| NFL18SP157X1A3□ | 150MHz                    | 34pF±20%    | 100nH±20%  | 100mA         | 10Vdc         | 1000M ohm                    | 30Vdc             | -55°C to +125°C             | Kit |
| NFL18SP207X1A3□ | 200MHz                    | 24pF±20%    | 80nH±20%   | 100mA         | 10Vdc         | 1000M ohm                    | 30Vdc             | -55°C to +125°C             | Kit |
| NFL18SP307X1A3□ | 300MHz                    | 19pF±20%    | 60nH±20%   | 100mA         | 10Vdc         | 1000M ohm                    | 30Vdc             | -55°C to +125°C             | Kit |
| NFL18SP507X1A3□ | 500MHz                    | 11pF±20%    | 38nH±20%   | 100mA         | 10Vdc         | 1000M ohm                    | 30Vdc             | -55°C to +125°C             | Kit |

Number of Circuits: 1

### ■ Insertion Loss Characteristics (Main Items)

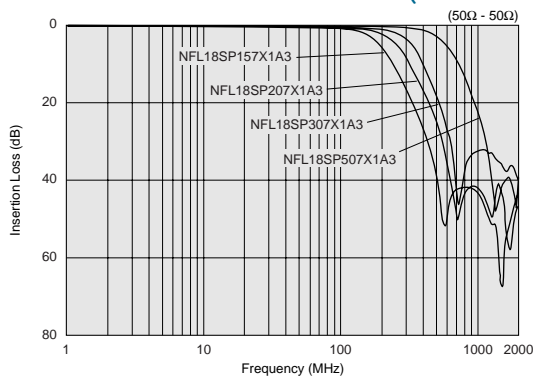

⚠Note • Please read rating and ⚠CAUTION (for storage, operating, rating, soldering, mounting and handling) in this catalog to prevent smoking and/or burning, etc.  
• This catalog has only typical specifications because there is no space for detailed specifications. Therefore, please review our product specifications or consult the approval sheet for product specifications before ordering.

# NFL21SP Series (0805 Size)



PI-type LC filter. Reduce waveform distortion of high speed signal.

### ■ Dimensions

0.3±0.2    0.4±0.2  
0.85±0.1  
0.6±0.2  
2.0±0.2  
0.25±0.2  
1.25±0.1

Legend:  Electrode (in mm)

### ■ Equivalent Circuit

(1) Input    Output (3)  
GND (2)  
No polarity.

### ■ Packaging

| Code | Packaging             | Minimum Quantity |
|------|-----------------------|------------------|
| D    | 180mm Reel Paper Tape | 4000             |
| B    | Bulk(Bag)             | 1000             |

Refer to pages from p.139 to p.144 for mounting information.

### ■ Rated Value (□: packaging code)

| Part Number     | Nominal Cut-off Frequency | Capacitance | Inductance | Rated Current | Rated Voltage | Insulation Resistance (min.) | Withstand Voltage | Operating Temperature Range |     |
|-----------------|---------------------------|-------------|------------|---------------|---------------|------------------------------|-------------------|-----------------------------|-----|
| NFL21SP106X1C3□ | 10MHz                     | 670pF±20%   | 680nH±20%  | 100mA         | 16Vdc         | 1000M ohm                    | 50Vdc             | -55°C to +125°C             | Kit |
| NFL21SP206X1C7□ | 20MHz                     | 240pF±20%   | 700nH±20%  | 100mA         | 16Vdc         | 1000M ohm                    | 50Vdc             | -55°C to +125°C             | Kit |
| NFL21SP506X1C3□ | 50MHz                     | 84pF±20%    | 305nH±20%  | 150mA         | 16Vdc         | 1000M ohm                    | 50Vdc             | -55°C to +125°C             | Kit |
| NFL21SP706X1C3□ | 70MHz                     | 76pF±20%    | 185nH±20%  | 150mA         | 16Vdc         | 1000M ohm                    | 50Vdc             | -55°C to +125°C             | Kit |
| NFL21SP107X1C3□ | 100MHz                    | 44pF±20%    | 135nH±20%  | 200mA         | 16Vdc         | 1000M ohm                    | 50Vdc             | -55°C to +125°C             | Kit |
| NFL21SP157X1C3□ | 150MHz                    | 28pF±20%    | 128nH±20%  | 200mA         | 16Vdc         | 1000M ohm                    | 50Vdc             | -55°C to +125°C             | Kit |
| NFL21SP207X1C3□ | 200MHz                    | 22pF±20%    | 72nH±20%   | 250mA         | 16Vdc         | 1000M ohm                    | 50Vdc             | -55°C to +125°C             | Kit |
| NFL21SP307X1C3□ | 300MHz                    | 19pF±10%    | 45nH±10%   | 300mA         | 16Vdc         | 1000M ohm                    | 50Vdc             | -55°C to +125°C             | Kit |
| NFL21SP407X1C3□ | 400MHz                    | 16pF±10%    | 34nH±10%   | 300mA         | 16Vdc         | 1000M ohm                    | 50Vdc             | -55°C to +125°C             | Kit |
| NFL21SP507X1C3□ | 500MHz                    | 12pF±10%    | 31nH±10%   | 300mA         | 16Vdc         | 1000M ohm                    | 50Vdc             | -55°C to +125°C             | Kit |

Number of Circuits: 1

### ■ Insertion Loss Characteristics (Main Items)

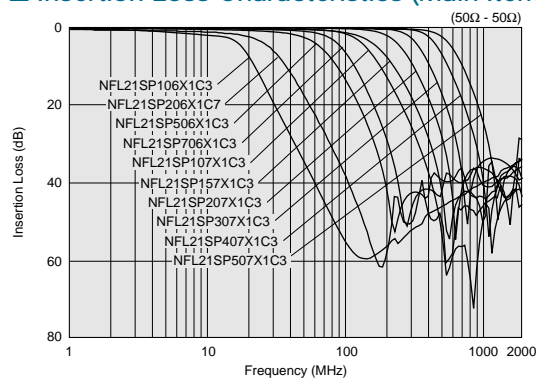

△Note • Please read rating and △CAUTION (for storage, operating, rating, soldering, mounting and handling) in this catalog to prevent smoking and/or burning, etc.  
 • This catalog has only typical specifications because there is no space for detailed specifications. Therefore, please review our product specifications or consult the approval sheet for product specifications before ordering.

# NFA18SL Series (0603 Size)



LC filter 4-lines array for mobile phones.

NFA18SL 137/187/207/357 V1A45  
NFA18SL506X1A45



### Dimensions

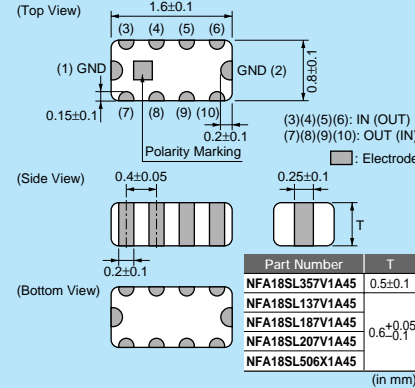

### Equivalent Circuit

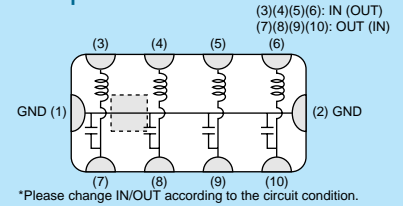

### Packaging

| Code | Packaging                | Minimum Quantity |
|------|--------------------------|------------------|
| L    | 180mm Reel Embossed Tape | 4000             |
| B    | Bulk(Bag)                | 1000             |

NFA18SL227V1A45



### Dimensions

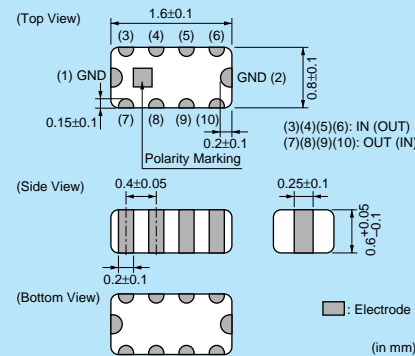

### Equivalent Circuit

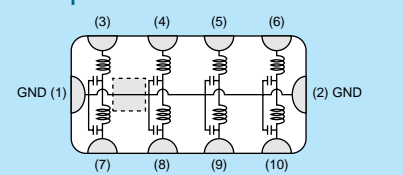

### Packaging

| Code | Packaging                | Minimum Quantity |
|------|--------------------------|------------------|
| L    | 180mm Reel Embossed Tape | 4000             |
| B    | Bulk(Bag)                | 1000             |

NFA18SL 307/407/487 V1A45



### Dimensions

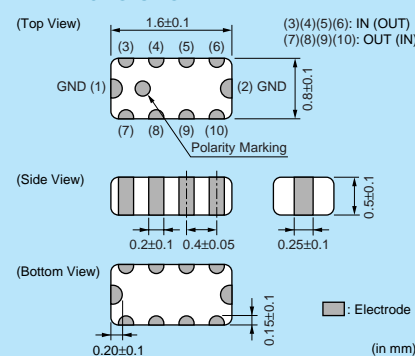

### Equivalent Circuit

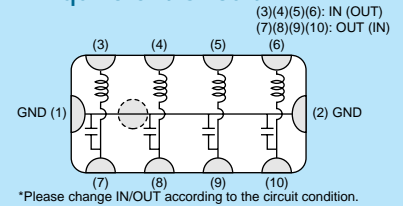

### Packaging

| Code | Packaging                | Minimum Quantity |
|------|--------------------------|------------------|
| L    | 180mm Reel Embossed Tape | 4000             |
| B    | Bulk(Bag)                | 1000             |

Refer to pages from p.139 to p.144 for mounting information.

### Rated Value (□: packaging code)

| Part Number      | Nominal Cut-off Frequency | Insertion Loss (Cut-off Frequency) | Insertion Loss (470MHz) (min.) | Insertion Loss (800MHz) (min.) | Insertion Loss (900MHz) (min.) | Insertion Loss (2000MHz) (min.) | Rated Current | Rated Voltage | Insulation Resistance (min.) | Withstand Voltage | Kit     | OTV |
|------------------|---------------------------|------------------------------------|--------------------------------|--------------------------------|--------------------------------|---------------------------------|---------------|---------------|------------------------------|-------------------|---------|-----|
| NFA18SL137V1A45□ | 130MHz                    | 6dBmax                             | 25dB                           | -                              | 25dB                           | -                               | 50mA          | 10Vdc         | 1000M ohm                    | 30Vdc             | Kit     | OTV |
| NFA18SL187V1A45□ | 180MHz                    | 6dBmax                             | 20dB                           | -                              | 20dB                           | -                               | 50mA          | 10Vdc         | 1000M ohm                    | 30Vdc             | Kit     | OTV |
| NFA18SL207V1A45□ | 200MHz                    | 6dBmax                             | 15dB                           | -                              | 15dB                           | -                               | 50mA          | 10Vdc         | 1000M ohm                    | 30Vdc             | Kit     | OTV |
| NFA18SL227V1A45□ | 220MHz                    | 6dBmax                             | -                              | -                              | 30dB                           | 30dB                            | 25mA          | 10Vdc         | 1000M ohm                    | 30Vdc             | Kit     | OTV |
| NFA18SL307V1A45□ | 300MHz                    | 6dBmax                             | -                              | 20dB                           | 20dB                           | -                               | 100mA         | 10Vdc         | 1000M ohm                    | 30Vdc             | Kit     |     |
| NFA18SL357V1A45□ | 350MHz                    | 6dBmax                             | -                              | -                              | 15dB                           | 13dB                            | 35mA          | 10Vdc         | 1000M ohm                    | 30Vdc             | New Kit |     |
| NFA18SL407V1A45□ | 400MHz                    | 6dBmax                             | -                              | 18dB                           | 18dB                           | -                               | 100mA         | 10Vdc         | 1000M ohm                    | 30Vdc             | Kit     |     |
| NFA18SL487V1A45□ | 480MHz                    | 6dBmax                             | -                              | 15dB                           | 15dB                           | -                               | 100mA         | 10Vdc         | 1000M ohm                    | 30Vdc             | Kit     |     |

Operating Temperature Range: -40°C to +85°C (NFA18SL 137/187/207/227/357 V1A45), -55°C to +125°C (NFA18SL 307/407/487 V1A45) Number of Circuits: 4 Continued on the following page. □

△Note • Please read rating and △CAUTION (for storage, operating, rating, soldering, mounting and handling) in this catalog to prevent smoking and/or burning, etc.  
• This catalog has only typical specifications because there is no space for detailed specifications. Therefore, please review our product specifications or consult the approval sheet for product specifications before ordering.

■ Insertion Loss Characteristics (Main Items)

NFA18SL 137/187/207 V1A45

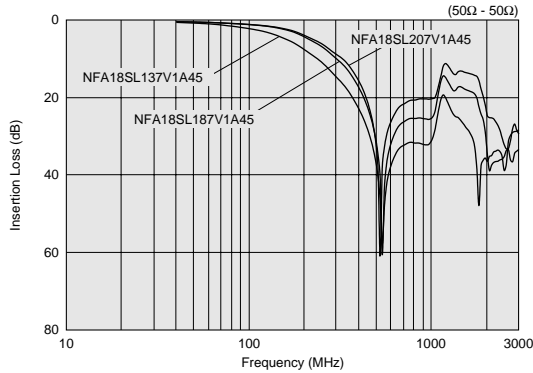

NFA18SL227V1A45

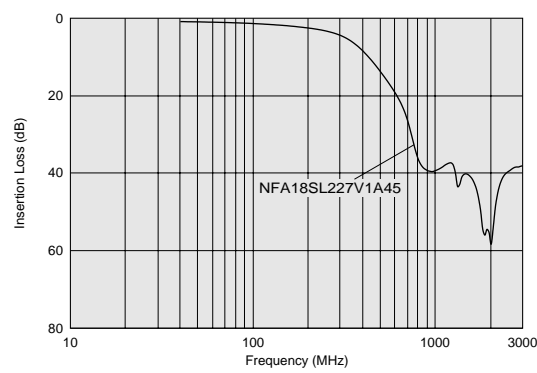

NFA18SL 307/407/487 V1A45

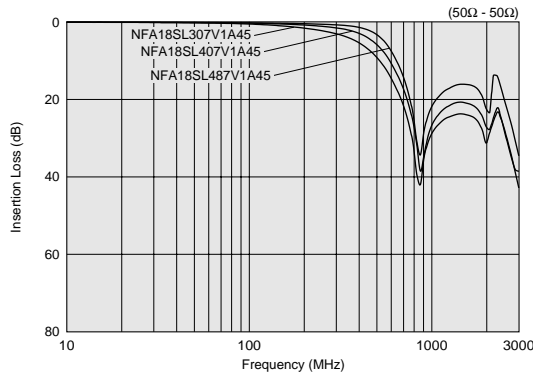

NFA18SL357V1A45

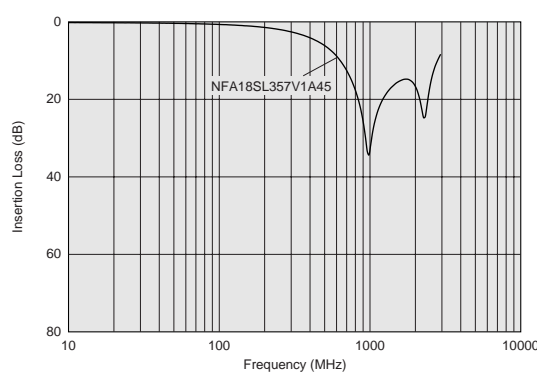

■ Rated Value (□: packaging code)

| Part Number      | Nominal Cut-off Frequency | Insertion Loss (Cut-off Frequency) | Insertion Loss at 500MHz (min.) | Insertion Loss at 1000MHz (min.) | Rated Voltage | Rated Current | Insulation Resistance (min.) | Withstand Voltage |     |
|------------------|---------------------------|------------------------------------|---------------------------------|----------------------------------|---------------|---------------|------------------------------|-------------------|-----|
| NFA18SL506X1A45□ | 50MHz                     | 6dBmax                             | 30dB                            | 25dB                             | 10Vdc         | 25mA          | 1000M ohm                    | 30Vdc             | Kit |

Operating Temperature Range: -40°C to +85°C Number of Circuits: 4

■ Insertion Loss Characteristics (Main Items)

NFA18SL\_X

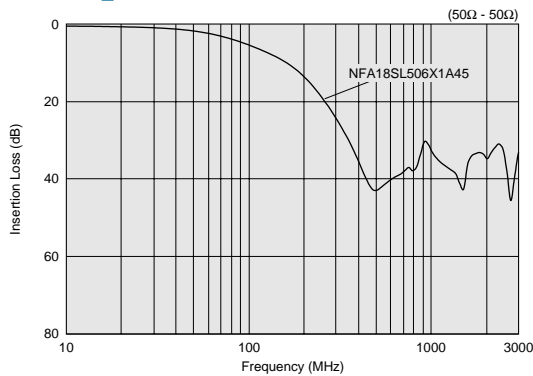

△Note • Please read rating and △CAUTION (for storage, operating, rating, soldering, mounting and handling) in this catalog to prevent smoking and/or burning, etc.  
• This catalog has only typical specifications because there is no space for detailed specifications. Therefore, please review our product specifications or consult the approval sheet for product specifications before ordering.

# NFA18SD Series (0603 Size)



For differential signal I/F of LCD or camera in mobile phones.

### ■ Dimensions

(Top View) 1.6±0.1, 0.8±0.1, 0.15±0.1, 0.2±0.1, (3)(4)(5)(6), (7)(8)(9)(10), (1) GND, GND (2), Polarity Marking

(Side View) 0.4±0.05, 0.25±0.1, 0.6±0.05, 0.2±0.1

(Bottom View)

Legend:  Electrode (in mm)

### ■ Equivalent Circuit

### ■ Packaging

| Code | Packaging                | Minimum Quantity |
|------|--------------------------|------------------|
| L    | 180mm Reel Embossed Tape | 4000             |
| B    | Bulk(Bag)                | 1000             |

Refer to pages from p.139 to p.144 for mounting information.

### ■ Rated Value (□: packaging code)

| Part Number      | Nominal Cut-off Frequency | Insertion Loss (Cut-off Frequency) | Insertion Loss (500MHz) (min.) | Insertion Loss (900MHz) (min.) | Insertion Loss (1500MHz) (min.) | Insertion Loss (2000MHz) (min.) | Rated Voltage | Rated Current | Insulation Resistance (min.) | Withstand Voltage |         |
|------------------|---------------------------|------------------------------------|--------------------------------|--------------------------------|---------------------------------|---------------------------------|---------------|---------------|------------------------------|-------------------|---------|
| NFA18SD187X1A45□ | 180MHz                    | 6dBmax                             | 15dB                           | 20dB                           | 20dB                            | 20dB                            | 10Vdc         | 25mA          | 1000M ohm                    | 30Vdc             | Kit QTV |
| NFA18SD207X1A45□ | 200MHz                    | 6dBmax                             | 13dB                           | 20dB                           | 20dB                            | 20dB                            | 10Vdc         | 25mA          | 1000M ohm                    | 30Vdc             | Kit QTV |

Operating Temperature Range: -40°C to +85°C Number of Circuits: 4

### ■ Insertion Loss Characteristics (Main Items)

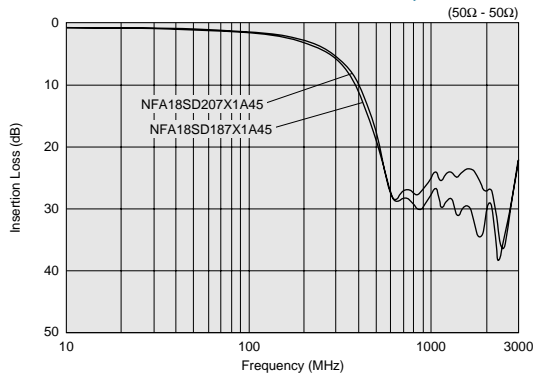

△Note • Please read rating and △CAUTION (for storage, operating, rating, soldering, mounting and handling) in this catalog to prevent smoking and/or burning, etc.  
 • This catalog has only typical specifications because there is no space for detailed specifications. Therefore, please review our product specifications or consult the approval sheet for product specifications before ordering.



# NFA21SL Series (0805 Size)



L-type LC filter 4-lines array for mobile phones.

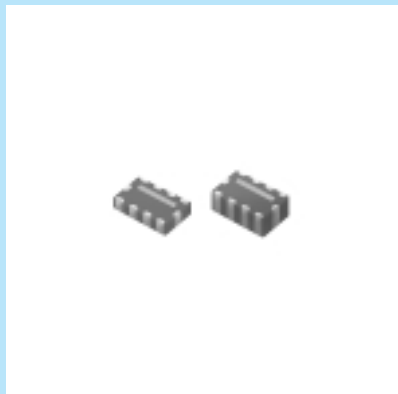

### ■ Dimensions

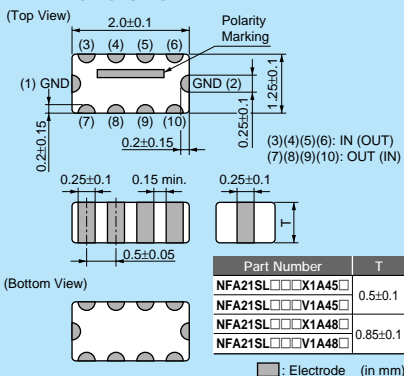

### ■ Equivalent Circuit

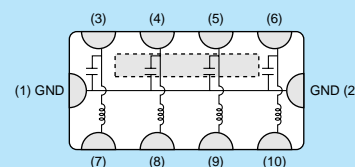

### ■ Packaging

| Code | Packaging                | Minimum Quantity |
|------|--------------------------|------------------|
| L    | 180mm Reel Embossed Tape | 4000             |
| B    | Bulk(Bag)                | 1000             |

Refer to pages from p.139 to p.144 for mounting information.

### ■ Rated Value (□: packaging code)

| Part Number      | Nominal Cut-off Frequency | Insertion Loss (Cut-off Frequency) | Insertion Loss at 800MHz (min.) | Insertion Loss at 900MHz (min.) | Rated Voltage | Rated Current | Insulation Resistance (min.) | Withstand Voltage |     |
|------------------|---------------------------|------------------------------------|---------------------------------|---------------------------------|---------------|---------------|------------------------------|-------------------|-----|
| NFA21SL287V1A45□ | 280MHz                    | 6dBmax                             | 25dB                            | 25dB                            | 10Vdc         | 100mA         | 1000M ohm                    | 30Vdc             | Kit |
| NFA21SL317V1A45□ | 310MHz                    | 6dBmax                             | 20dB                            | 20dB                            | 10Vdc         | 100mA         | 1000M ohm                    | 30Vdc             | Kit |
| NFA21SL337V1A45□ | 330MHz                    | 6dBmax                             | 15dB                            | 15dB                            | 10Vdc         | 100mA         | 1000M ohm                    | 30Vdc             | Kit |
| NFA21SL287V1A48□ | 280MHz                    | 6dBmax                             | 25dB                            | 25dB                            | 10Vdc         | 100mA         | 1000M ohm                    | 30Vdc             | Kit |
| NFA21SL317V1A48□ | 310MHz                    | 6dBmax                             | 20dB                            | 20dB                            | 10Vdc         | 100mA         | 1000M ohm                    | 30Vdc             | Kit |
| NFA21SL337V1A48□ | 330MHz                    | 6dBmax                             | 20dB                            | 20dB                            | 10Vdc         | 100mA         | 1000M ohm                    | 30Vdc             | Kit |

Operating Temperature Range: -55°C to +125°C Number of Circuits: 4

### ■ Insertion Loss Characteristics (Main Items)

NFA21SL\_V1A45

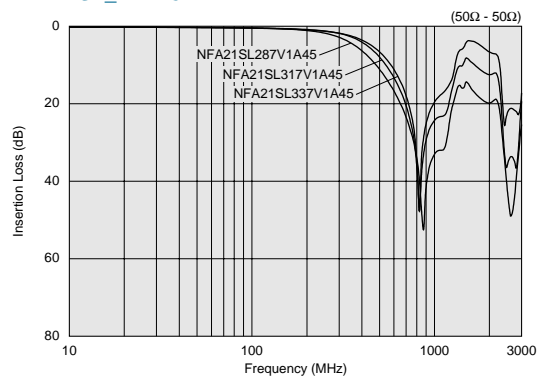

NFA21SL\_V1A48

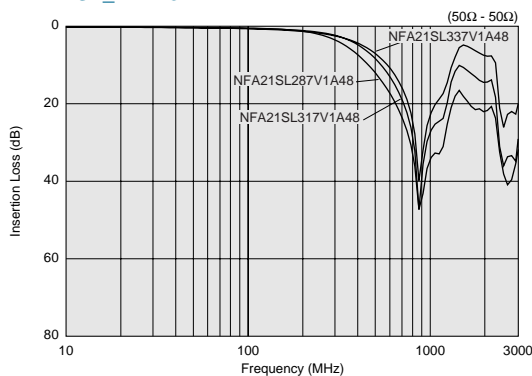

Continued on the following page. ↗

△Note • Please read rating and △CAUTION (for storage, operating, rating, soldering, mounting and handling) in this catalog to prevent smoking and/or burning, etc.  
 • This catalog has only typical specifications because there is no space for detailed specifications. Therefore, please review our product specifications or consult the approval sheet for product specifications before ordering.

■ Rated Value (□: packaging code)

| Part Number      | Nominal Cut-off Frequency | Insertion Loss (Cut-off Frequency) | Insertion Loss at 500MHz (min.) | Insertion Loss at 800MHz (min.) | Insertion Loss at 1000MHz (min.) | Rated Voltage | Rated Current | Insulation Resistance (min.) | Withstand Voltage |     |
|------------------|---------------------------|------------------------------------|---------------------------------|---------------------------------|----------------------------------|---------------|---------------|------------------------------|-------------------|-----|
| NFA21SL207X1A45□ | 200MHz                    | 2 to 7                             | 13dB                            | 25dB                            | 25dB                             | 10Vdc         | 100mA         | 1000M ohm                    | 30Vdc             | Kit |
| NFA21SL307X1A45□ | 300MHz                    | 2 to 7                             | 7dB                             | 20dB                            | 25dB                             | 10Vdc         | 100mA         | 1000M ohm                    | 30Vdc             | Kit |
| NFA21SL506X1A48□ | 50MHz                     | 0 to 6                             | 30dB                            | -                               | 20dB                             | 10Vdc         | 20mA          | 1000M ohm                    | 30Vdc             | Kit |
| NFA21SL806X1A48□ | 80MHz                     | 2 to 7                             | 25dB                            | -                               | 25dB                             | 10Vdc         | 20mA          | 1000M ohm                    | 30Vdc             | Kit |
| NFA21SL207X1A48□ | 200MHz                    | 2 to 7                             | 13dB                            | 25dB                            | 25dB                             | 10Vdc         | 100mA         | 1000M ohm                    | 30Vdc             | Kit |
| NFA21SL307X1A48□ | 300MHz                    | 2 to 7                             | 7dB                             | 20dB                            | 25dB                             | 10Vdc         | 100mA         | 1000M ohm                    | 30Vdc             | Kit |

Operating Temperature Range: -55°C to +125°C Number of Circuits: 4

■ Insertion Loss Characteristics (Main Items)

NFA21SL\_X



△Note • Please read rating and △CAUTION (for storage, operating, rating, soldering, mounting and handling) in this catalog to prevent smoking and/or burning, etc.  
 • This catalog has only typical specifications because there is no space for detailed specifications. Therefore, please review our product specifications or consult the approval sheet for product specifications before ordering.

# NFW31S Series (1206 Size)



## Wire-wound PI-type LC filter.



### ■ Dimensions

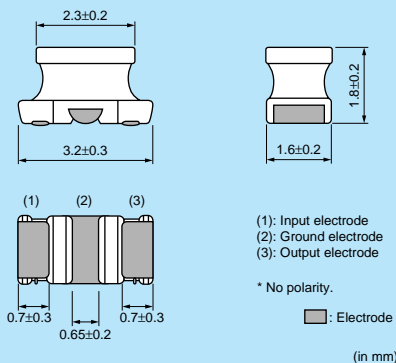

### ■ Equivalent Circuit



### ■ Packaging

| Code | Packaging                | Minimum Quantity |
|------|--------------------------|------------------|
| L    | 180mm Reel Embossed Tape | 2000             |
| K    | 330mm Reel Embossed Tape | 7500             |

Refer to pages from p.139 to p.144 for mounting information.

### ■ Rated Value (□: packaging code)

| Part Number     | Nominal Cut-off Frequency | Insertion Loss at 10MHz | Insertion Loss at 20MHz | Insertion Loss at 50MHz | Insertion Loss at 100MHz | Insertion Loss at 150MHz | Insertion Loss at 200MHz | Insertion Loss at 300MHz | Insertion Loss at 400MHz | Insertion Loss at 500MHz | Insertion Loss at 1000MHz |     |
|-----------------|---------------------------|-------------------------|-------------------------|-------------------------|--------------------------|--------------------------|--------------------------|--------------------------|--------------------------|--------------------------|---------------------------|-----|
| NFW31SP106X1E4□ | 10MHz                     | 6dBmax.                 | 5dBmin.                 | 25dBmin.                | 25dBmin.                 | -                        | 25dBmin.                 | -                        | -                        | 30dBmin.                 | 30dBmin.                  | Kit |
| NFW31SP206X1E4□ | 20MHz                     | -                       | 6dBmax.                 | 5dBmin.                 | 25dBmin.                 | -                        | 25dBmin.                 | -                        | -                        | 30dBmin.                 | 30dBmin.                  | Kit |
| NFW31SP506X1E4□ | 50MHz                     | -                       | -                       | 6dBmax.                 | 10dBmin.                 | -                        | 30dBmin.                 | -                        | -                        | 30dBmin.                 | 30dBmin.                  | Kit |
| NFW31SP107X1E4□ | 100MHz                    | -                       | -                       | -                       | 6dBmax.                  | -                        | 5dBmin.                  | -                        | -                        | 20dBmin.                 | 30dBmin.                  | Kit |
| NFW31SP157X1E4□ | 150MHz                    | -                       | -                       | -                       | -                        | 6dBmax.                  | -                        | 10dBmin.                 | 20dBmin.                 | 30dBmin.                 | 30dBmin.                  | Kit |
| NFW31SP207X1E4□ | 200MHz                    | -                       | -                       | -                       | -                        | -                        | 6dBmax.                  | -                        | -                        | 10dBmin.                 | 30dBmin.                  | Kit |
| NFW31SP307X1E4□ | 300MHz                    | -                       | -                       | -                       | -                        | -                        | -                        | 6dBmax.                  | -                        | 5dBmin.                  | 15dBmin.                  | Kit |
| NFW31SP407X1E4□ | 400MHz                    | -                       | -                       | -                       | -                        | -                        | -                        | -                        | 6dBmax.                  | -                        | 10dBmin.                  | Kit |
| NFW31SP507X1E4□ | 500MHz                    | -                       | -                       | -                       | -                        | -                        | -                        | -                        | -                        | 6dBmax.                  | 10dBmin.                  | Kit |

Rated Current: 200mA Rated Voltage: 25Vdc Operating Temperature Range: -40°C to +85°C Number of Circuit: 1

### ■ Insertion Loss Characteristics (Main Items)



△Note • Please read rating and △CAUTION (for storage, operating, rating, soldering, mounting and handling) in this catalog to prevent smoking and/or burning, etc.  
• This catalog has only typical specifications because there is no space for detailed specifications. Therefore, please review our product specifications or consult the approval sheet for product specifications before ordering.

Chip Ferrite Bead

Chip EMIFIL®  
Signal Lines Type

Chip Common Mode Choke Coil

Block Type EMIFIL®

## Example of EMI Suppression in an Actual Circuit

### Measuring Circuit



| Type of Filter                                            | Signal Wave Form (20ns/div / 1V/div) / EMI Suppression Effect / Description                                                                                                                                                              |
|-----------------------------------------------------------|------------------------------------------------------------------------------------------------------------------------------------------------------------------------------------------------------------------------------------------|
| Signal Waveform and Noise Spectrum before Filter Mounting | <p>Signal Waveform (20ns/div / 1V/div)</p> <p>Noise Spectrum (10:1 Active Probe)</p>                                                                                                                                                     |
| NFW31S Series (Cut-off frequency 50MHz)                   | <p>NFW31S's steep attenuation characteristic means excellent EMI suppression without waveform cornering.</p>                                                                                                                             |
| Conventional Chip Solid Type EMI Filter (NFM41CC 470pF)   | <p>3-terminal capacitors suppress signal frequencies as EMI frequencies so the signal waveform is distorted.</p>                                                                                                                         |
| Filter Combined with Conventional LCs                     | <p>Combinations of inductors and capacitors can yield a steep attenuation characteristic, but they require a great deal more mounting space. Moreover, at high frequencies the EMI suppression is less than that obtained by NFW31S.</p> |

△Note • Please read rating and △CAUTION (for storage, operating, rating, soldering, mounting and handling) in this catalog to prevent smoking and/or burning, etc.  
• This catalog has only typical specifications because there is no space for detailed specifications. Therefore, please review our product specifications or consult the approval sheet for product specifications before ordering.

# NFR21G Series (0805 Size)



3-terminal RC filter, damp the noise current and return back to ground.



### Dimensions

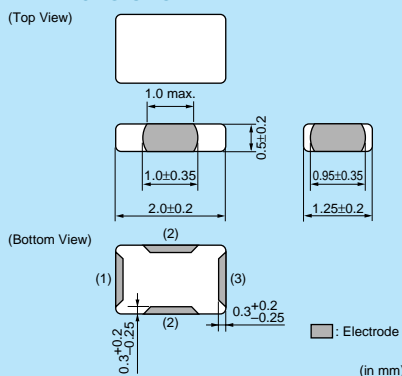

### Equivalent Circuit

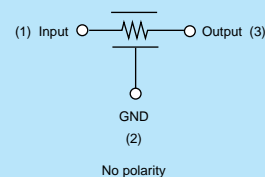

### Packaging

| Code | Packaging                | Minimum Quantity |
|------|--------------------------|------------------|
| L    | 180mm Reel Embossed Tape | 4000             |
| B    | Bulk(Bag)                | 500              |

Refer to pages from p.139 to p.144 for mounting information.

### Rated Value (□: packaging code)

| Part Number     | Capacitance | DC Resistance | Rated Current | Rated Voltage | Insulation Resistance (min.) | Operating Temperature Range |
|-----------------|-------------|---------------|---------------|---------------|------------------------------|-----------------------------|
| NFR21GD1002202□ | 10pF±20%    | 22ohm±30%     | 50mA          | 50Vdc         | 1000M ohm                    | -40°C to +85°C              |
| NFR21GD1004702□ | 10pF±20%    | 47ohm±30%     | 35mA          | 50Vdc         | 1000M ohm                    | -40°C to +85°C              |
| NFR21GD4702202□ | 47pF±20%    | 22ohm±30%     | 50mA          | 50Vdc         | 1000M ohm                    | -40°C to +85°C              |
| NFR21GD4704702□ | 47pF±20%    | 47ohm±30%     | 35mA          | 50Vdc         | 1000M ohm                    | -40°C to +85°C              |
| NFR21GD4706802□ | 47pF±20%    | 68ohm±30%     | 30mA          | 50Vdc         | 1000M ohm                    | -40°C to +85°C              |
| NFR21GD4701012□ | 47pF±20%    | 100ohm±30%    | 25mA          | 50Vdc         | 1000M ohm                    | -40°C to +85°C              |
| NFR21GD1012202□ | 100pF±20%   | 22ohm±30%     | 50mA          | 50Vdc         | 1000M ohm                    | -40°C to +85°C              |
| NFR21GD1014702□ | 100pF±20%   | 47ohm±30%     | 35mA          | 50Vdc         | 1000M ohm                    | -40°C to +85°C              |
| NFR21GD1016802□ | 100pF±20%   | 68ohm±30%     | 30mA          | 50Vdc         | 1000M ohm                    | -40°C to +85°C              |
| NFR21GD1011012□ | 100pF±20%   | 100ohm±30%    | 25mA          | 50Vdc         | 1000M ohm                    | -40°C to +85°C              |

Number of Circuit: 1

### Insertion Loss Characteristics (Main Items)

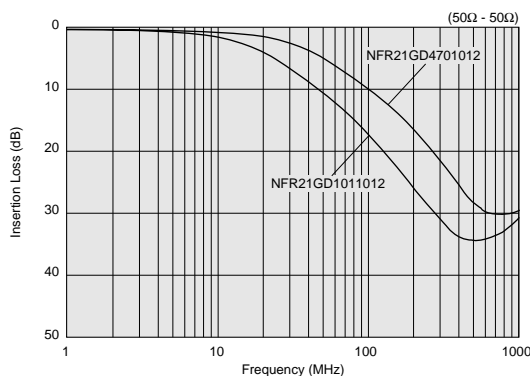
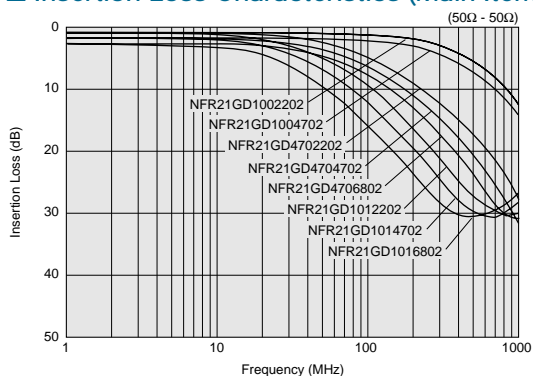

Note • Please read rating and CAUTION (for storage, operating, rating, soldering, mounting and handling) in this catalog to prevent smoking and/or burning, etc.  
 • This catalog has only typical specifications because there is no space for detailed specifications. Therefore, please review our product specifications or consult the approval sheet for product specifications before ordering.

# NFA31G Series (1206 Size)



## 3-terminal RC filter array.

### ■ Dimensions

(Top View) (7) (8) (9) (10)

(Bottom View)

(in mm)

### ■ Equivalent Circuit

Output  
No polarity.

### ■ Packaging

| Code | Packaging             | Minimum Quantity |
|------|-----------------------|------------------|
| D    | 180mm Reel Paper Tape | 4000             |
| B    | Bulk(Bag)             | 100              |

Refer to pages from p.139 to p.144 for mounting information.

### ■ Rated Value (□: packaging code)

| Part Number     | Capacitance | DC Resistance | Rated Current | Rated Voltage | Insulation Resistance (min.) | Operating Temperature Range |
|-----------------|-------------|---------------|---------------|---------------|------------------------------|-----------------------------|
| NFA31GD1006R84□ | 10pF±20%    | 6.8ohm±40%    | 50mA          | 6Vdc          | 1000M ohm                    | -40°C to +85°C              |
| NFA31GD1004704□ | 10pF±20%    | 47ohm±30%     | 20mA          | 6Vdc          | 1000M ohm                    | -40°C to +85°C              |
| NFA31GD1001014□ | 10pF±20%    | 100ohm±30%    | 15mA          | 6Vdc          | 1000M ohm                    | -40°C to +85°C              |
| NFA31GD4706R84□ | 47pF±20%    | 6.8ohm±40%    | 50mA          | 6Vdc          | 1000M ohm                    | -40°C to +85°C              |
| NFA31GD4703304□ | 47pF±20%    | 33ohm±30%     | 20mA          | 6Vdc          | 1000M ohm                    | -40°C to +85°C              |
| NFA31GD4704704□ | 47pF±20%    | 47ohm±30%     | 20mA          | 6Vdc          | 1000M ohm                    | -40°C to +85°C              |
| NFA31GD4701014□ | 47pF±20%    | 100ohm±30%    | 15mA          | 6Vdc          | 1000M ohm                    | -40°C to +85°C              |
| NFA31GD1016R84□ | 100pF±20%   | 6.8ohm±40%    | 50mA          | 6Vdc          | 1000M ohm                    | -40°C to +85°C              |
| NFA31GD1014704□ | 100pF±20%   | 47ohm±30%     | 20mA          | 6Vdc          | 1000M ohm                    | -40°C to +85°C              |
| NFA31GD1011014□ | 100pF±20%   | 100ohm±30%    | 15mA          | 6Vdc          | 1000M ohm                    | -40°C to +85°C              |

Number of Circuit: 4

### ■ Insertion Loss Characteristics (Main Items)

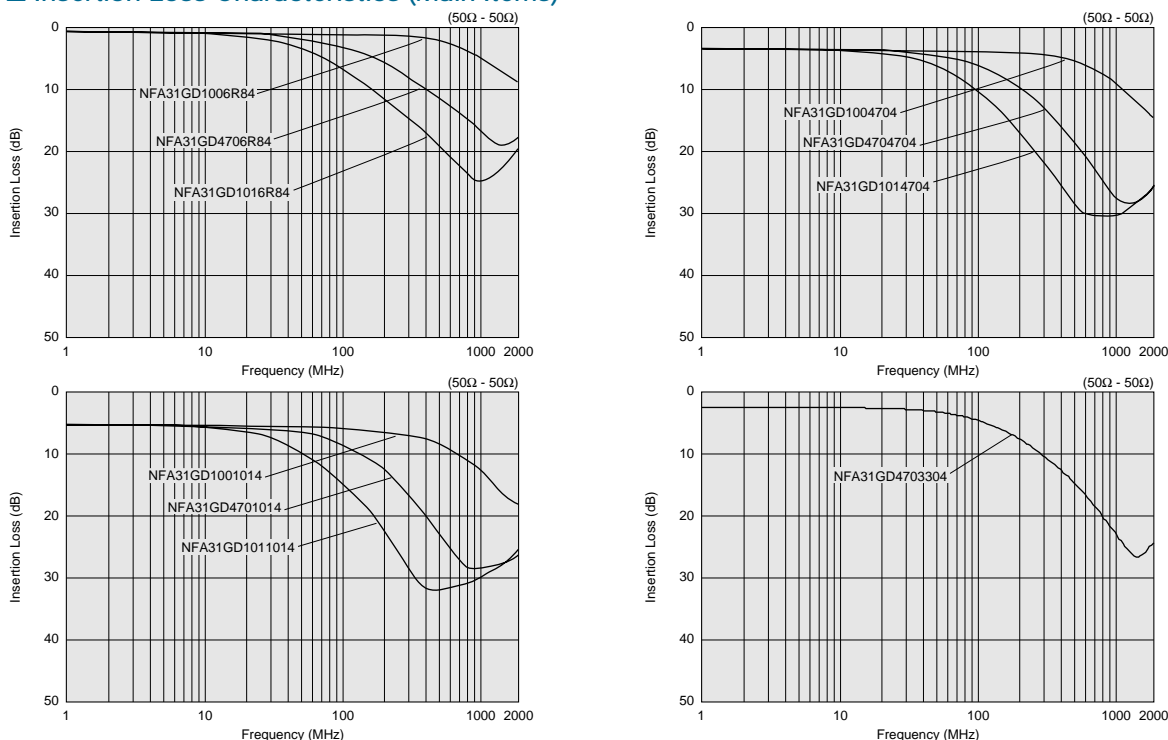

△Note • Please read rating and △CAUTION (for storage, operating, rating, soldering, mounting and handling) in this catalog to prevent smoking and/or burning, etc.  
 • This catalog has only typical specifications because there is no space for detailed specifications. Therefore, please review our product specifications or consult the approval sheet for product specifications before ordering.

Signal Lines Type Chip EMIFIL®  
Chip Ferrite Bead  
Chip Common Mode Choke Coil  
Block Type EMIFIL®

## ⚠ Caution

## ● Rating

Do not use products beyond the rated current and rated voltage as this may create excessive heat and deteriorate the insulation resistance.

## ● Soldering and Mounting

## • Self-heating

Please provide special attention when mounting chip EMIFIL<sup>®</sup> NFM\_P series in close proximity to other products that radiate heat.

The heat generated by other products may deteriorate the insulation resistance and cause excessive heat in this component.

## Notice

## ● Storage and Operating Conditions

## &lt;Operating Environment&gt;

Do not use products in a chemical atmosphere such as chlorine gas, acid or sulfide gas.

Do not use products in the environment close to the organic solvent.

## &lt;Storage and Handling Requirements&gt;

## 1. Storage Period

NFM55P series should be used within 6 months, the other series should be used within 12 months.

Solderability should be checked if this period is exceeded.

## 2. Storage Conditions

(1) Storage temperature: -10 to +40°C

Relative humidity: 15 to 85%

Avoid sudden changes in temperature and humidity.

(2) Do not store products in a chemical atmosphere such as chlorine gas, acid or sulfide gas.

## ● Notice (Soldering and Mounting)

## 1. Cleaning

Failure and degradation of a product are caused by the cleaning method. When you clean in conditions that are not in mounting information, please contact Murata engineering.

## 2. Soldering

Reliability decreases with improper soldering methods. Please solder by the standard soldering conditions shown in mounting information.

## 3. Other

Noise suppression levels resulting from Murata's EMI suppression filters EMIFIL<sup>®</sup> may vary, depending on the circuits and ICs used, type of noise, mounting pattern, mounting location, and other operating conditions. Be sure to check and confirm in advance the noise suppression effect of each filter, in actual circuits, etc. before applying the filter in a commercial-purpose equipment design.

## ● Handling

## 1. Resin Coating

Using resin for coating/molding products may affect the products performance.

So please pay careful attention in selecting resin.

Prior to use, please make the reliability evaluation with the product mounted in your application set.

## 2. Caution for Use (NFW Series)

When you hold products with a tweezer, please hold by the sides. Sharp materials, such as a pair of tweezers or other material such as bristles of cleaning brush, should not touch the winding portion of this product to prevent breaking the wire. Mechanical shock should not be applied to the products mounted on the board to prevent breaking the core.

## 3. Handling of a Substrate

After mounting products on a substrate, do not apply any stress to the product caused by bending or twisting to the substrate when cropping the substrate, inserting and removing a connector from the substrate or tightening screw to the substrate. Excessive mechanical stress may cause cracking in the Product.

Bending

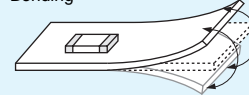

Twisting

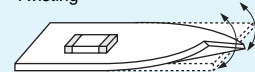

## 1. Standard Land Pattern Dimensions

NF□ series suppress noise by conducting the high-frequency noise element to ground. Therefore, to obtain maximum performance from these filters, the ground pattern should be made as large as possible during the PCB design stage. As shown below, one side of the PCB is used for chip mounting, and the other is used for grounding.

Small diameter feedthrough holes are then used to connect the grounds on each side of the PCB. This reduces the high-frequency impedance of the grounding and maximizes the filter's performance.



  
 Land Pattern + Solder Resist (dark grey)
   
 Land Pattern (light grey)
   
 Solder Resist (white)
   
 (in mm)

**NFM18**  
**NFL18**  
**NFM55P**

Reflow Soldering

NFM18C/NFM18PC/NFL18ST

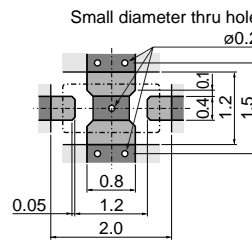
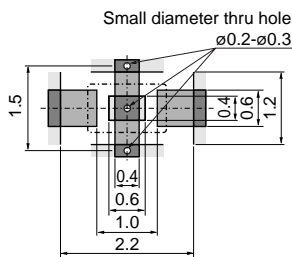
NFM18PS



NFL18SP

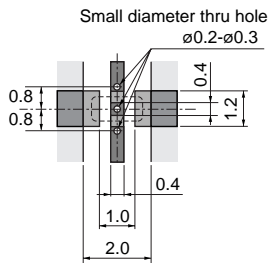

NFM55P

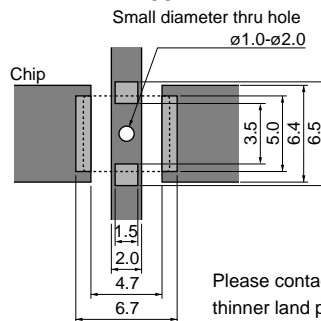

Please contact us if using thinner land pad than 18µm.

• NF□18, NFM55P are specially adapted for reflow soldering.

**NFM21C**  
**NFM21P**  
**NFM3D**  
**NFM31P**  
**NFM41**  
**NFR21G**  
**NFL21S**

● Reflow Soldering Chip mounting side

NFM21C/NFR21G  
NFM21P/NFL21S

NFM3DC/NFM3DP/  
NFM31P  
NFM41C/NFM41P

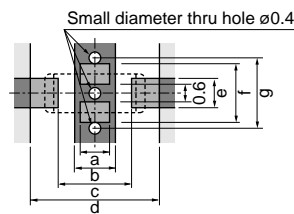
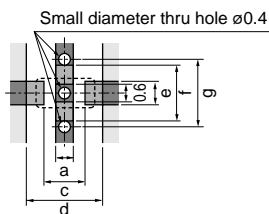

| Part Number                    | Size (mm) |     |     |     |     |     |     |
|--------------------------------|-----------|-----|-----|-----|-----|-----|-----|
|                                | a         | b   | c   | d   | e   | f   | g   |
| NFM21C/NFR21G<br>NFM21P/NFL21S | 0.6       | -   | 1.4 | 2.6 | 0.8 | 1.9 | 2.3 |
| NFM3DC/NFM3DP                  | 1.0       | 1.4 | 2.5 | 4.4 | 1.0 | 2.0 | 2.4 |
| NFM31P                         | 1.0       | 1.4 | 2.5 | 4.4 | 1.2 | 2.6 | 3.0 |
| NFM41C/NFM41P                  | 1.5       | 2.0 | 3.5 | 6.0 | 1.2 | 2.6 | 3.0 |

• NF□21 is specially adapted for reflow soldering.

● Flow Soldering  
Chip mounting side

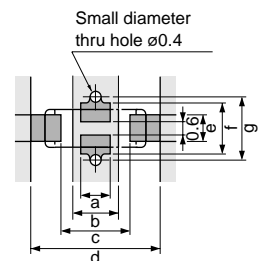

| Part Number      | Size (mm) |     |     |     |     |     |     |
|------------------|-----------|-----|-----|-----|-----|-----|-----|
|                  | a         | b   | c   | d   | e   | f   | g   |
| NFM3DC<br>NFM3DP | 1.0       | 1.4 | 2.5 | 4.4 | 1.0 | 2.0 | 2.4 |
| NFM31P           | 1.0       | 1.4 | 2.5 | 4.4 | 1.2 | 2.6 | 3.0 |
| NFM41C<br>NFM41P | 1.5       | 2.0 | 3.5 | 6.0 | 1.2 | 2.6 | 3.0 |

Continued on the following page. 

△Note • Please read rating and △CAUTION (for storage, operating, rating, soldering, mounting and handling) in this catalog to prevent smoking and/or burning, etc.  
• This catalog has only typical specifications because there is no space for detailed specifications. Therefore, please review our product specifications or consult the approval sheet for product specifications before ordering.



Land Pattern + Solder Resist  
 Land Pattern  
 Solder Resist (in mm)

|                                                                            |                                                                                 |                                                                                                               |
|----------------------------------------------------------------------------|---------------------------------------------------------------------------------|---------------------------------------------------------------------------------------------------------------|
| <p><b>NFA18S</b><br/><b>NFA21S</b></p>                                     | <p>Reflow Soldering</p> <p style="text-align: center;"><b>NFA18S</b></p>        | <p style="text-align: center;"><b>NFA21S</b></p>                                                              |
| <p><b>NFA31G</b><br/><b>NFA31C</b><br/><b>NFW31S</b><br/><b>NFE31P</b></p> | <ul style="list-style-type: none"> <li>● Reflow Soldering NFA31G/31C</li> </ul> | <ul style="list-style-type: none"> <li>● Reflow and Flow NFW31S</li> <li>● Reflow Soldering NFE31P</li> </ul> |
| <p><b>NFE61P</b></p>                                                       | <ul style="list-style-type: none"> <li>● Reflow Soldering</li> </ul>            | <ul style="list-style-type: none"> <li>● Flow Soldering</li> </ul>                                            |

● PCB Warping

PCB should be designed so that products are not subjected to the mechanical stress caused by warping the board.

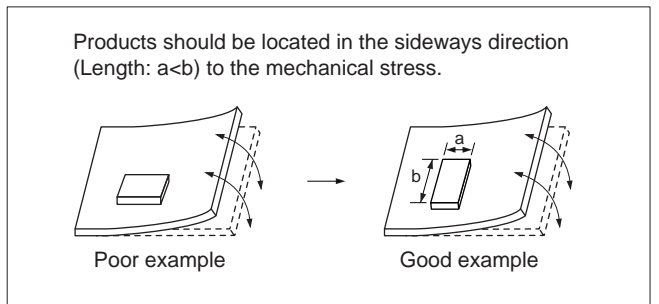

△Note • Please read rating and △CAUTION (for storage, operating, rating, soldering, mounting and handling) in this catalog to prevent smoking and/or burning, etc.  
 • This catalog has only typical specifications because there is no space for detailed specifications. Therefore, please review our product specifications or consult the approval sheet for product specifications before ordering.

2. Solder Paste Printing and Adhesive Application

When reflow soldering the chip EMI suppression filter, the printing must be conducted in accordance with the following cream solder printing conditions.

If too much solder is applied, the chip will be prone to damage by mechanical and thermal stress from the PCB and may crack.

Standard land dimensions should be used for resist and copper foil patterns.

When flow soldering the EMI suppression filter, apply the adhesive in accordance with the following conditions. If too much adhesive is applied, then it may overflow into the land or termination areas and yield poor solderability. In contrast, if insufficient adhesive is applied, or if the adhesive is not sufficiently hardened, then the chip may become detached during flow soldering process.

(in mm)

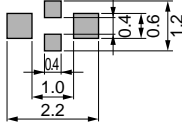
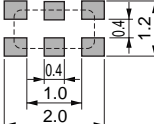
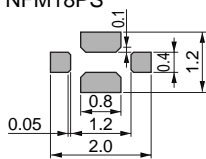
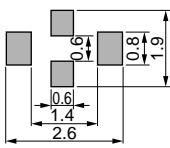
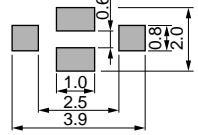
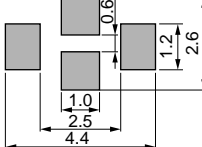
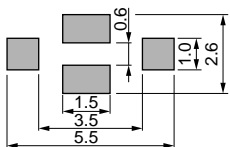
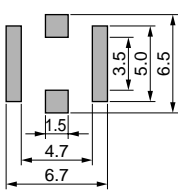
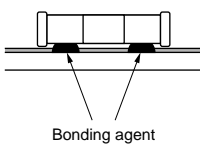
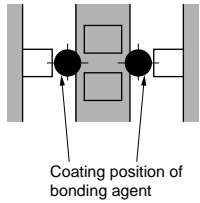
| Series                                          | Solder Paste Printing                                                                                                                                                                                                                                                                                                                                                                                                                                                                                                                                                                                                                                                                                                                                                                                                                                                                                                                                                                                                                                                                                                                                                                                                                                                                                                                                                                                                                                                                                                                                                                                                                                                    | Adhesive Application                                                                                                                                                                                                                                                                                                                                                                                                                |
|-------------------------------------------------|--------------------------------------------------------------------------------------------------------------------------------------------------------------------------------------------------------------------------------------------------------------------------------------------------------------------------------------------------------------------------------------------------------------------------------------------------------------------------------------------------------------------------------------------------------------------------------------------------------------------------------------------------------------------------------------------------------------------------------------------------------------------------------------------------------------------------------------------------------------------------------------------------------------------------------------------------------------------------------------------------------------------------------------------------------------------------------------------------------------------------------------------------------------------------------------------------------------------------------------------------------------------------------------------------------------------------------------------------------------------------------------------------------------------------------------------------------------------------------------------------------------------------------------------------------------------------------------------------------------------------------------------------------------------------|-------------------------------------------------------------------------------------------------------------------------------------------------------------------------------------------------------------------------------------------------------------------------------------------------------------------------------------------------------------------------------------------------------------------------------------|
| <p><b>NFM</b><br/><b>NFR</b><br/><b>NFL</b></p> | <p>● Guideline of solder paste thickness:<br/>                     100-150μm: NFM18/21/3D/31P, NFR, NFL<br/>                     150-200μm: NFM55P<br/>                     100-200μm: NFM41</p> <div style="display: flex; justify-content: space-around;"> <div style="width: 45%;"> <p>NFM18C/18PC<br/>NFL18ST</p>  </div> <div style="width: 45%;"> <p>NFL18SP</p>  </div> </div> <div style="display: flex; justify-content: space-around; margin-top: 10px;"> <div style="width: 45%;"> <p>NFM18PS</p>  </div> <div style="width: 45%;"> <p>NFM21C/21PC<br/>NFR21G/NFL21S</p>  </div> </div> <div style="display: flex; justify-content: space-around; margin-top: 10px;"> <div style="width: 45%;"> <p>NFM3DC/3DP</p>  </div> <div style="width: 45%;"> <p>NFM31P</p>  </div> </div> <div style="display: flex; justify-content: space-around; margin-top: 10px;"> <div style="width: 45%;"> <p>NFM41C/41P</p>  </div> <div style="width: 45%;"> <p>NFM55P</p>  </div> </div> | <p>■ NFM3D/31P/41 Series<br/>                     Apply 0.1mg for NFM41C/41 and 0.06mg for NFM3D/NFM31P of bonding agent at each chip. Do not cover electrodes.</p> <div style="display: flex; justify-content: space-around; align-items: center;">   </div> |

Continued on the following page. ↗

△Note • Please read rating and △CAUTION (for storage, operating, rating, soldering, mounting and handling) in this catalog to prevent smoking and/or burning, etc.  
 • This catalog has only typical specifications because there is no space for detailed specifications. Therefore, please review our product specifications or consult the approval sheet for product specifications before ordering.

(in mm)

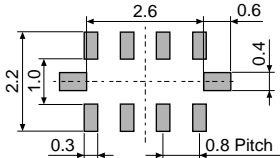
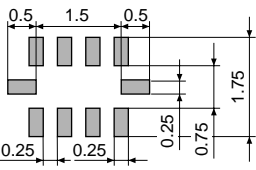
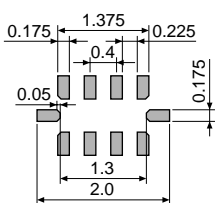
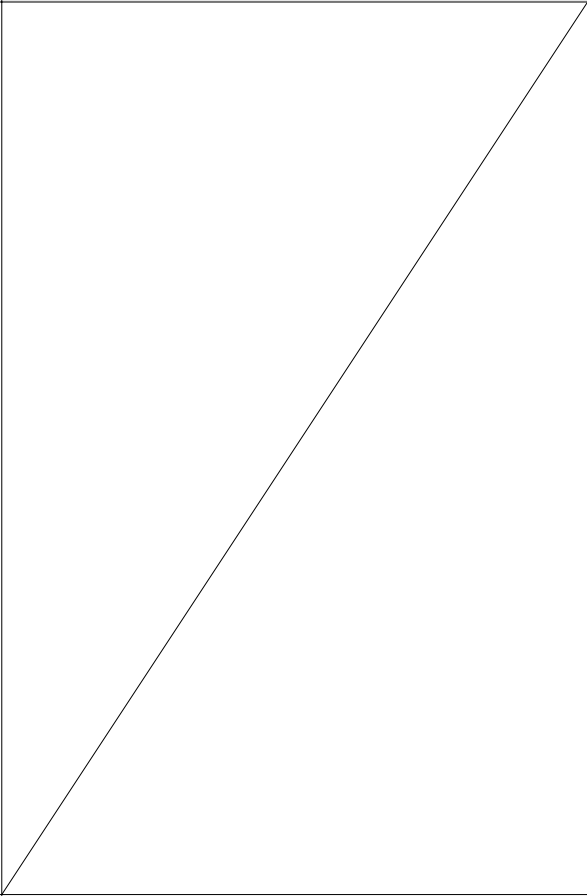
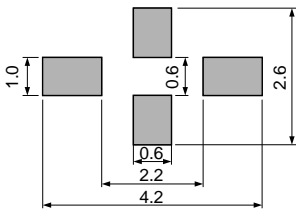
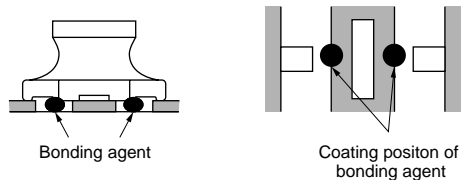
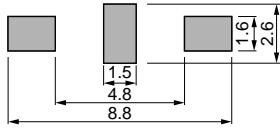
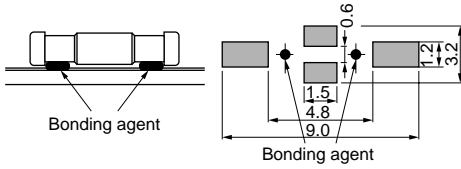
| Series                                 | Solder Paste Printing                                                                                                                                                                                                                                                                                                                                                                                 | Adhesive Application                                                                                                                                              |
|----------------------------------------|-------------------------------------------------------------------------------------------------------------------------------------------------------------------------------------------------------------------------------------------------------------------------------------------------------------------------------------------------------------------------------------------------------|-------------------------------------------------------------------------------------------------------------------------------------------------------------------|
| <p><b>NFA</b></p>                      | <p>●Guideline of solder paste thickness:<br/>100-200μm: NFA31G/31C<br/>100-150μm: NFA18S/21S</p> <p>NFA31G/31C</p>  <p>NFA21S</p>  <p>NFA18S</p>  |                                                                                |
| <p><b>NFW31S</b><br/><b>NFE31P</b></p> | <p>●Guideline of solder paste thickness:<br/>150-200μm</p>                                                                                                                                                                                                                                                         | <p>■ <b>NFW31S Series</b><br/>Apply 0.2mg of bonding agent at each chip.</p>  |
| <p><b>NFE61P</b></p>                   | <p>●Guideline of solder paste thickness:<br/>150-200μm</p>                                                                                                                                                                                                                                                         | <p>Apply 1.0mg of bonding agent at each chip.</p>                             |

△Note • Please read rating and △CAUTION (for storage, operating, rating, soldering, mounting and handling) in this catalog to prevent smoking and/or burning, etc.  
• This catalog has only typical specifications because there is no space for detailed specifications. Therefore, please review our product specifications or consult the approval sheet for product specifications before ordering.

Chip Ferrite Bead  
Chip EMIFIL®  
Soldering and Mounting  
Chip Common Mode Choke Coil  
Block Type EMIFIL®

3. Standard Soldering Conditions

(1) Soldering Methods

Use flow and reflow soldering methods only.  
 Use standard soldering conditions when soldering chip EMI suppression filters.  
 In cases where several different parts are soldered, each having different soldering conditions, use those conditions requiring the least heat and minimum time.

Flux:

- Use Rosin-based flux.  
 In case of using RA type solder, products should be cleaned completely with no residual flux.
- Do not use strong acidic flux (with chlorine content exceeding 0.20wt%)
- Do not use water-soluble flux.

Solder: Use Sn-3.0Ag-0.5Cu solder. Use of Sn-Zn based solder will deteriorate performance of products.  
 If using NFM series with Sn-Zn based solder, please contact Murata in advance.

For additional mounting methods, please contact Murata.

(2) Soldering Profile

● Flow Soldering Profile (Sn-3.0Ag-0.5Cu Solder)

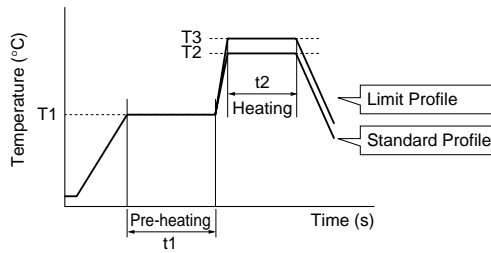

| Series                                  | Pre-heating |            | Standard Profile |            |               | Limit Profile |            |               |
|-----------------------------------------|-------------|------------|------------------|------------|---------------|---------------|------------|---------------|
|                                         | Temp. (T1)  | Time. (t1) | Heating          |            | Cycle of Flow | Heating       |            | Cycle of Flow |
|                                         |             |            | Temp. (T2)       | Time. (t2) |               | Temp. (T3)    | Time. (t2) |               |
| NFM3DC/3DP/31PC<br>NFM41C/41P<br>NFE61P | 150°C       | 60s min.   | 250°C            | 4 to 6s    | 2 times max.  | 265±3°C       | 5s max.    | 2 times max.  |
| NFW31S                                  | 150°C       | 60s min.   | 250°C            | 4 to 6s    | 2 times max.  | 265±3°C       | 5s max.    | 1 time        |

● Reflow Soldering Profile (Sn-3.0Ag-0.5Cu Solder)

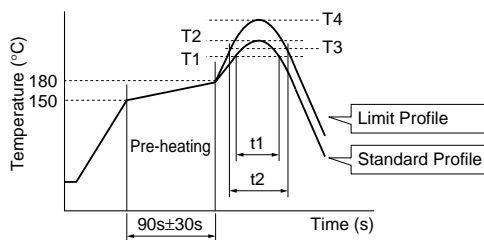

| Series                                      | Standard Profile |            |                       |                 | Limit Profile |            |                       |                 |
|---------------------------------------------|------------------|------------|-----------------------|-----------------|---------------|------------|-----------------------|-----------------|
|                                             | Heating          |            | Peak Temperature (T2) | Cycle of Reflow | Heating       |            | Peak Temperature (T4) | Cycle of Reflow |
|                                             | Temp. (T1)       | Time. (t1) |                       |                 | Temp. (T3)    | Time. (t2) |                       |                 |
| NFA, NFE<br>NFL, NFM (Except NFM55P)<br>NFR | 220°C min.       | 30 to 60s  | 245±3°C               | 2 times max.    | 230°C min.    | 60s max.   | 260°C/10s             | 2 times max.    |
| NFW31S, NFM55P                              | 220°C min.       | 30 to 60s  | 245±3°C               | 2 times max.    | 230°C min.    | 60s max.   | 260°C/10s             | 1 time          |

△Note • Please read rating and △CAUTION (for storage, operating, rating, soldering, mounting and handling) in this catalog to prevent smoking and/or burning, etc.  
 • This catalog has only typical specifications because there is no space for detailed specifications. Therefore, please review our product specifications or consult the approval sheet for product specifications before ordering.

## (3) Reworking with Solder Iron

The following conditions must be strictly followed when using a soldering iron.

Pre-heating: 150°C 60s min.\*<sup>1</sup>

\*<sup>1</sup> NFM55P: 100°C/60s+200°C/60s

Soldering iron power output / Tip diameter:

30W max. / ø3mm max.

Temperature of soldering iron tip / Soldering time / Times:

350°C max. / 3-4s / 2 times\*<sup>2</sup>

\*<sup>2</sup> NFE31PT152Z1E9: 280°C max. / 10s max. / 2 times

Do not allow the tip of the soldering iron to directly contact the chip.

For additional methods of reworking with a soldering iron, please contact Murata engineering.

#### 4. Cleaning

Following conditions should be observed when cleaning chip EMI filter.

(1) Cleaning Temperature: 60°C max. (40°C max. for alcohol type cleaner)

(2) Ultrasonic

Output: 20W/liter max.

Duration: 5 minutes max.

Frequency: 28 to 40kHz

(3) Cleaning Agent

The following list of cleaning agents have been tested on the individual components. Evaluation of final assembly should be completed prior to production.

(a) Alcohol cleaning agent

Isopropyl alcohol (IPA)

(b) Aqueous cleaning agent

Pine Alpha ST-100S

(4) Ensure that flux residue is completely removed.

Component should be thoroughly dried after aqueous agent has been removed with deionized water.

## Minimum Quantity and Dimensions of 8mm Width Paper / Embossed Tape

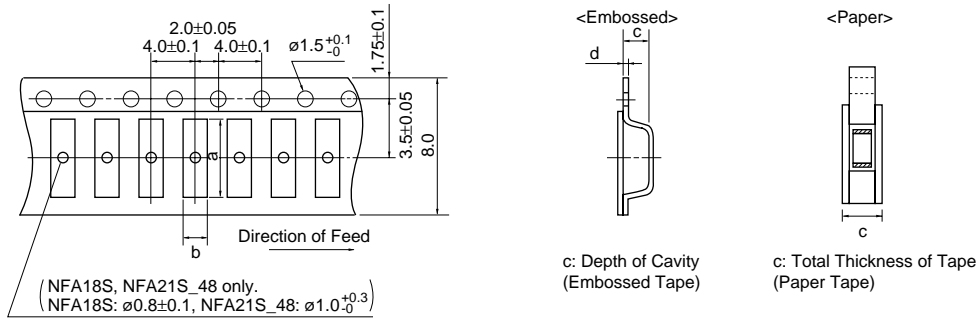

Dimension of the cavity of embossed tape is measured at the bottom side.

| Part Number                                                  | Cavity Size |      |          |      | Minimum Qty. (pcs.) |               |             |               | Bulk |
|--------------------------------------------------------------|-------------|------|----------|------|---------------------|---------------|-------------|---------------|------|
|                                                              | a           | b    | c        | d    | ø180mm Reel         |               | ø330mm Reel |               |      |
|                                                              |             |      |          |      | Paper Tape          | Embossed Tape | Paper Tape  | Embossed Tape |      |
| <b>NFM18C/<br/>NFM18PC (Except 105R/225B1A)/<br/>NFM18PS</b> | 1.85        | 1.05 | 0.9 max. | -    | 4000                | -             | -           | -             | 500  |
| <b>NFM18PC105R/225B1A</b>                                    |             |      | 1.1 max. | -    | 4000                | -             | -           | -             | 500  |
| <b>NFL18SP</b>                                               | 1.85        | 1.05 | 0.9 max. | -    | 4000                | -             | -           | -             | 1000 |
| <b>NFL18ST</b>                                               |             |      | 1.1 max. |      |                     |               |             |               |      |
| <b>NFL21SP</b>                                               | 2.3         | 1.55 | 1.1 max. | -    | -                   | -             | -           | -             | 500  |
| <b>NFM21</b>                                                 | 2.3         | 1.55 | 1.1 max. | -    | 4000                | -             | -           | -             | 500  |
| <b>NFM3DC/3DP</b>                                            | 3.4         | 1.4  | 0.85     | 0.2  | -                   | 4000          | -           | -             | 500  |
| <b>NFM31P</b>                                                | 3.5         | 1.9  | 1.5      | 0.25 | -                   | 3000          | -           | -             | 500  |
| <b>NFA18S</b>                                                | 1.8         | 1.0  | 0.7      | 0.25 | -                   | 4000          | -           | -             | 1000 |
| <b>NFA21S_45</b>                                             | 2.30        | 1.55 | 0.7      | 0.25 | -                   | 4000          | -           | -             | 1000 |
| <b>NFA21S_48</b>                                             | 2.25        | 1.45 | 1.05     | 0.25 | -                   | 4000          | -           | -             | 1000 |
| <b>NFA31G/31C</b>                                            | 3.5         | 2.0  | 1.1 max. | -    | 4000                | -             | -           | -             | 100  |
| <b>NFE31P</b>                                                | 3.6         | 1.8  | 1.85     | 0.2  | -                   | 2000          | -           | 8000          | 500  |
| <b>NFR21G</b>                                                | 2.3         | 1.55 | 0.7      | 0.25 | -                   | 4000          | -           | -             | 500  |
| <b>NFW31S</b>                                                | 3.6         | 1.9  | 2.0      | 0.2  | -                   | 2000          | -           | 7500          | -    |

(in mm)

## Minimum Quantity and Dimensions of 12mm Width Embossed Tape

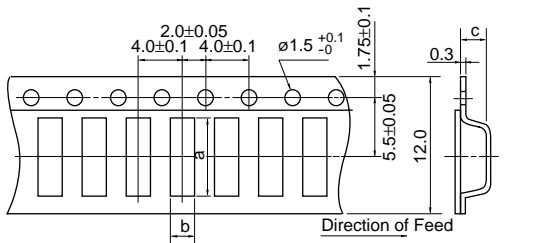

c: Depth of Cavity

| Part Number  | Cavity Size |     |      | Minimum Qty. (pcs.) |             |      |
|--------------|-------------|-----|------|---------------------|-------------|------|
|              | a           | b   | c    | ø180mm Reel         | ø330mm Reel | Bulk |
| <b>NFM41</b> | 4.8         | 1.8 | 1.1  | 4000                | -           | 500  |
| <b>NFE61</b> | 7.2         | 1.9 | 1.75 | 2500                | 8000        | 500  |

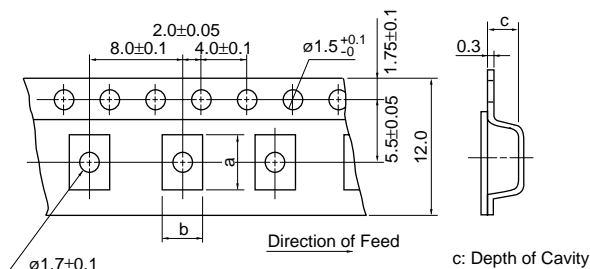

c: Depth of Cavity

| Part Number   | Cavity Size |     |     | Minimum Qty. (pcs.) |             |      |
|---------------|-------------|-----|-----|---------------------|-------------|------|
|               | a           | b   | c   | ø180mm Reel         | ø330mm Reel | Bulk |
| <b>NFM55P</b> | 6.0         | 5.3 | 2.5 | 500                 | -           | 100  |

Dimension of the cavity is measured at the bottom side.

(in mm)

"Minimum Quantity" means the number of units of each delivery or order. The quantity should be an integral multiple of the "Minimum Quantity".

⚠Note • Please read rating and ⚠CAUTION (for storage, operating, rating, soldering, mounting and handling) in this catalog to prevent smoking and/or burning, etc.  
• This catalog has only typical specifications because there is no space for detailed specifications. Therefore, please review our product specifications or consult the approval sheet for product specifications before ordering.

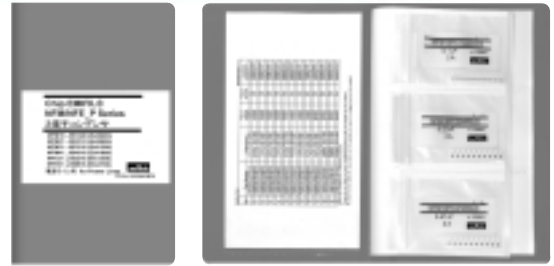

●EKEMNFMCB (Chip EMIFIL® Capacitor Type for Signal Lines)

| No. | Part Number    | Quantity (pcs.) | Capacitance | Rated Voltage (Vdc) | Rated Current (mA) |
|-----|----------------|-----------------|-------------|---------------------|--------------------|
| 1   | NFM18CC220U1C3 | 10              | 22pF±20%    | 16                  | 400                |
| 2   | NFM18CC470U1C3 | 10              | 47pF±20%    | 16                  | 400                |
| 3   | NFM18CC101R1C3 | 10              | 47pF±20%    | 16                  | 500                |
| 4   | NFM18CC221R1C3 | 10              | 100pF±20%   | 16                  | 500                |
| 5   | NFM18CC471R1C3 | 10              | 220pF±20%   | 16                  | 500                |
| 6   | NFM18CC102R1C3 | 10              | 470pF±20%   | 16                  | 600                |
| 7   | NFM18CC222R1C3 | 10              | 1000pF±20%  | 16                  | 700                |
| 8   | NFM18CC223R1C3 | 10              | 2200pF±20%  | 16                  | 1000               |
| 9   | NFM21CC220U1H3 | 10              | 22000pF±20% | 50                  | 700                |
| 10  | NFM21CC470U1H3 | 10              | 22pF±20%    | 50                  | 700                |
| 11  | NFM21CC101U1H3 | 10              | 100pF±20%   | 50                  | 700                |
| 12  | NFM21CC221R1H3 | 10              | 220pF±20%   | 50                  | 700                |
| 13  | NFM21CC471R1H3 | 10              | 470pF±20%   | 50                  | 1000               |
| 14  | NFM21CC102R1H3 | 10              | 1000pF±20%  | 50                  | 1000               |
| 15  | NFM21CC222R1H3 | 10              | 2200pF±20%  | 50                  | 1000               |
| 16  | NFM21CC223R1H3 | 10              | 22000pF±20% | 50                  | 2000               |

●EKEMFA31E (Chip EMIFIL® Capacitor Array Type/ RC Combined Array Type)

| No. | Part Number    | Quantity (pcs.) | Capacitance | Rated Voltage (Vdc) | Rated Current (mA) |
|-----|----------------|-----------------|-------------|---------------------|--------------------|
| 1   | NFA31CC220S1E4 | 10              | 22pF±20%    | 25                  | 200                |
| 2   | NFA31CC470S1E4 | 10              | 47pF±20%    | 25                  | 200                |
| 3   | NFA31CC101S1E4 | 10              | 100pF±20%   | 25                  | 200                |
| 4   | NFA31CC221S1E4 | 10              | 220pF±20%   | 25                  | 200                |
| 5   | NFA31CC471R1E4 | 10              | 470pF±20%   | 25                  | 200                |
| 6   | NFA31CC102R1E4 | 10              | 1000pF±20%  | 25                  | 200                |
| 7   | NFA31CC222R1E4 | 10              | 2200pF±20%  | 25                  | 200                |
| 8   | NFA31CC223R1C4 | 10              | 22000pF±20% | 16                  | 200                |

●EKEMFL18F (Chip EMIFIL® LC Combined Type)

| No. | Part Number    | Quantity (pcs.) | Cut-off Frequency | Rated Voltage (Vdc) | Rated Current (mA) | DC Resistance (Ω) max. |
|-----|----------------|-----------------|-------------------|---------------------|--------------------|------------------------|
| 1   | NFL18ST506H1A3 | 10              | 50MHz             | 10                  | 75                 | -                      |
| 2   | NFL18ST706H1A3 | 10              | 70MHz             | 10                  | 75                 | -                      |
| 3   | NFL18ST107H1A3 | 10              | 100MHz            | 10                  | 75                 | -                      |
| 4   | NFL18ST207X1C3 | 10              | 200MHz            | 16                  | 150                | 3.5                    |
| 5   | NFL18ST307X1C3 | 10              | 300MHz            | 16                  | 200                | 1.8                    |
| 6   | NFL18ST507X1C3 | 10              | 500MHz            | 16                  | 200                | 1.5                    |
| 7   | NFL18SP157X1A3 | 10              | 150MHz            | 10                  | 100                | 3.0                    |
| 8   | NFL18SP207X1A3 | 10              | 200MHz            | 10                  | 100                | 3.0                    |
| 9   | NFL18SP307X1A3 | 10              | 300MHz            | 10                  | 100                | 3.0                    |
| 10  | NFL18SP507X1A3 | 10              | 500MHz            | 10                  | 100                | 2.0                    |
| 11  | NFL21SP106X1C3 | 10              | 10MHz             | 16                  | 100                | 8.5                    |
| 12  | NFL21SP206X1C7 | 10              | 20MHz             | 16                  | 100                | 8.5                    |
| 13  | NFL21SP506X1C3 | 10              | 50MHz             | 16                  | 150                | 3.5                    |
| 14  | NFL21SP706X1C3 | 10              | 70MHz             | 16                  | 150                | 3.0                    |
| 15  | NFL21SP107X1C3 | 10              | 100MHz            | 16                  | 200                | 2.0                    |
| 16  | NFL21SP157X1C3 | 10              | 150MHz            | 16                  | 200                | 2.0                    |
| 17  | NFL21SP207X1C3 | 10              | 200MHz            | 16                  | 250                | 1.5                    |
| 18  | NFL21SP307X1C3 | 10              | 300MHz            | 16                  | 300                | 1.2                    |
| 19  | NFL21SP407X1C3 | 10              | 400MHz            | 16                  | 300                | 1.2                    |
| 20  | NFL21SP507X1C3 | 10              | 500MHz            | 16                  | 300                | 1.2                    |

Continued on the following page. ↗

△Note • Please read rating and △CAUTION (for storage, operating, rating, soldering, mounting and handling) in this catalog to prevent smoking and/or burning, etc.  
 • This catalog has only typical specifications because there is no space for detailed specifications. Therefore, please review our product specifications or consult the approval sheet for product specifications before ordering.

Continued from the preceding page.

| No. | Part Number    | Quantity (pcs.) | Cut-off Frequency | Attenuation (dB min.) |          |          |          |          |          |          |          |          |      | Rated Current | Rated Voltage |
|-----|----------------|-----------------|-------------------|-----------------------|----------|----------|----------|----------|----------|----------|----------|----------|------|---------------|---------------|
|     |                |                 |                   | 10MHz                 | 20MHz    | 50MHz    | 100MHz   | 150MHz   | 200MHz   | 300MHz   | 400MHz   | 500MHz   | 1GHz |               |               |
| 21  | NFW31SP106X1E4 | 10              | 10MHz             | 6dB max.              | 5        | 25       | 25       | -        | 25       | -        | -        | 30       | 30   | 200mA         | 25V           |
| 22  | NFW31SP206X1E4 | 10              | 20MHz             | -                     | 6dB max. | 5        | 25       | -        | 25       | -        | -        | 30       | 30   | 200mA         | 25V           |
| 23  | NFW31SP506X1E4 | 10              | 50MHz             | -                     | -        | 6dB max. | 10       | -        | 30       | -        | -        | 30       | 30   | 200mA         | 25V           |
| 24  | NFW31SP107X1E4 | 10              | 100MHz            | -                     | -        | -        | 6dB max. | -        | 5        | -        | -        | 20       | 30   | 200mA         | 25V           |
| 25  | NFW31SP157X1E4 | 10              | 150MHz            | -                     | -        | -        | -        | 6dB max. | -        | 10       | 20       | 30       | 30   | 200mA         | 25V           |
| 26  | NFW31SP207X1E4 | 10              | 200MHz            | -                     | -        | -        | -        | -        | 6dB max. | -        | -        | 10       | 30   | 200mA         | 25V           |
| 27  | NFW31SP307X1E4 | 10              | 300MHz            | -                     | -        | -        | -        | -        | -        | 6dB max. | -        | 5        | 15   | 200mA         | 25V           |
| 28  | NFW31SP407X1E4 | 10              | 400MHz            | -                     | -        | -        | -        | -        | -        | -        | 6dB max. | -        | 10   | 200mA         | 25V           |
| 29  | NFW31SP507X1E4 | 10              | 500MHz            | -                     | -        | -        | -        | -        | -        | -        | -        | 6dB max. | 10   | 200mA         | 25V           |

●EKEMFA20H (Chip EMIFIL® LC Combined Array Type)

| No. | Part Number     | Quantity (pcs.) | Cut-off Frequency | Rated Voltage (Vdc) | Rated Current (mA) |
|-----|-----------------|-----------------|-------------------|---------------------|--------------------|
| 1   | NFA18SL506X1A45 | 10              | 50MHz             | 10                  | 25                 |
| 2   | NFA18SL137V1A45 | 10              | 130MHz            | 10                  | 50                 |
| 3   | NFA18SL187V1A45 | 10              | 180MHz            | 10                  | 50                 |
| 4   | NFA18SL207V1A45 | 10              | 200MHz            | 10                  | 50                 |
| 5   | NFA18SL227V1A45 | 10              | 220MHz            | 10                  | 25                 |
| 6   | NFA18SL307V1A45 | 10              | 300MHz            | 10                  | 100                |
| 7   | NFA18SL357V1A45 | 10              | 350MHz            | 10                  | 35                 |
| 8   | NFA18SL407V1A45 | 10              | 400MHz            | 10                  | 100                |
| 9   | NFA18SL487V1A45 | 10              | 480MHz            | 10                  | 100                |
| 10  | NFA18SD187X1A45 | 10              | 180MHz            | 10                  | 25                 |
| 11  | NFA18SD207X1A45 | 10              | 200MHz            | 10                  | 25                 |
| 12  | NFA21SL506X1A48 | 10              | 200MHz            | 10                  | 25                 |
| 13  | NFA21SL806X1A48 | 10              | 80MHz             | 10                  | 20                 |
| 14  | NFA21SL207X1A45 | 10              | 200MHz            | 10                  | 100                |
| 15  | NFA21SL207X1A48 | 10              | 200MHz            | 10                  | 100                |
| 16  | NFA21SL307X1A45 | 10              | 300MHz            | 10                  | 100                |
| 17  | NFA21SL307X1A48 | 10              | 300MHz            | 10                  | 100                |
| 18  | NFA21SL287V1A45 | 10              | 280MHz            | 10                  | 100                |
| 19  | NFA21SL287V1A48 | 10              | 280MHz            | 10                  | 100                |
| 20  | NFA21SL317V1A45 | 10              | 310MHz            | 10                  | 100                |
| 21  | NFA21SL317V1A48 | 10              | 310MHz            | 10                  | 100                |
| 22  | NFA21SL337V1A45 | 10              | 330MHz            | 10                  | 100                |
| 23  | NFA21SL337V1A48 | 10              | 330MHz            | 10                  | 100                |

●EKEMNFMPPH (Chip EMIFIL® for Large Current)

| No. | Part Number    | Quantity (pcs.) | Capacitance     | Rated Voltage (Vdc) | Rated Current (A) |
|-----|----------------|-----------------|-----------------|---------------------|-------------------|
| 1   | NFM18PC104R1C3 | 10              | 0.1µF±20%       | 16                  | 2                 |
| 2   | NFM18PC224R0J3 | 10              | 0.22µF±20%      | 6.3                 | 2                 |
| 3   | NFM18PC474R0J3 | 10              | 0.47µF±20%      | 6.3                 | 2                 |
| 4   | NFM18PC105R0J3 | 10              | 1µF±20%         | 6.3                 | 4                 |
| 5   | NFM18PC225B0J3 | 10              | 2.2µF±20%       | 6.3                 | 2                 |
| 6   | NFM18PC225B1A3 | 10              | 2.2µF±20%       | 10                  | 4                 |
| 7   | NFM18PS474R0J3 | 10              | 0.47µF±20%      | 6.3                 | 2                 |
| 8   | NFM18PS105R0J3 | 10              | 1µF±20%         | 6.3                 | 2                 |
| 9   | NFM21PC104R1E3 | 10              | 0.1µF±20%       | 25                  | 2                 |
| 10  | NFM21PC224R1C3 | 10              | 0.22µF±20%      | 16                  | 2                 |
| 11  | NFM21PC474R1C3 | 10              | 0.47µF±20%      | 16                  | 2                 |
| 12  | NFM21PC105B1A3 | 10              | 1µF±20%         | 10                  | 4                 |
| 13  | NFM21PC105B1C3 | 10              | 1µF±20%         | 16                  | 4                 |
| 14  | NFM21PC225B0J3 | 10              | 2.2µF±20%       | 6.3                 | 4                 |
| 15  | NFM21PC475B1A3 | 10              | 4.7µF±20%       | 10                  | 6                 |
| 16  | NFM31PC276B0J3 | 10              | 27µF±20%        | 6.3                 | 6                 |
| 17  | NFM41PC204F1H3 | 10              | 0.2µF +80/-20%  | 50                  | 2                 |
| 18  | NFM41PC155B1E3 | 10              | 1.5µF±20%       | 25                  | 6                 |
| 19  | NFE31PT152Z1E9 | 10              | 1500pF +50/-20% | 25                  | 6                 |
| 20  | NFE31PT222Z1E9 | 10              | 2200pF±50%      | 25                  | 6                 |
| 21  | NFE61PT102E1H9 | 10              | 1000pF +80/-20% | 50                  | 2                 |
| 22  | NFE61PT472C1H9 | 10              | 4700pF +80/-20% | 50                  | 2                 |

△Note • Please read rating and △CAUTION (for storage, operating, rating, soldering, mounting and handling) in this catalog to prevent smoking and/or burning, etc.  
 • This catalog has only typical specifications because there is no space for detailed specifications. Therefore, please review our product specifications or consult the approval sheet for product specifications before ordering.



Компания «Life Electronics» занимается поставками электронных компонентов импортного и отечественного производства от производителей и со складов крупных дистрибьюторов Европы, Америки и Азии.

С конца 2013 года компания активно расширяет линейку поставок компонентов по направлению коаксиальный кабель, кварцевые генераторы и конденсаторы (керамические, пленочные, электролитические), за счёт заключения дистрибьюторских договоров

Мы предлагаем:

- Конкурентоспособные цены и скидки постоянным клиентам.
- Специальные условия для постоянных клиентов.
- Подбор аналогов.
- Поставку компонентов в любых объемах, удовлетворяющих вашим потребностям.
- Приемлемые сроки поставки, возможна ускоренная поставка.
- Доставку товара в любую точку России и стран СНГ.
- Комплексную поставку.
- Работу по проектам и поставку образцов.
- Формирование склада под заказчика.
- Сертификаты соответствия на поставляемую продукцию (по желанию клиента).
- Тестирование поставляемой продукции.
- Поставку компонентов, требующих военную и космическую приемку.
- Входной контроль качества.
- Наличие сертификата ISO.

В составе нашей компании организован Конструкторский отдел, призванный помогать разработчикам, и инженерам.

Конструкторский отдел помогает осуществить:

- Регистрацию проекта у производителя компонентов.
- Техническую поддержку проекта.
- Защиту от снятия компонента с производства.
- Оценку стоимости проекта по компонентам.
- Изготовление тестовой платы монтаж и пусконаладочные работы.



Тел: +7 (812) 336 43 04 (многоканальный)  
Email: [org@lifeelectronics.ru](mailto:org@lifeelectronics.ru)