

CONTROL PANEL WITH FONTS, GRAPHICS COMMANDS AND MACROS

with and w/o.
Touch Panel

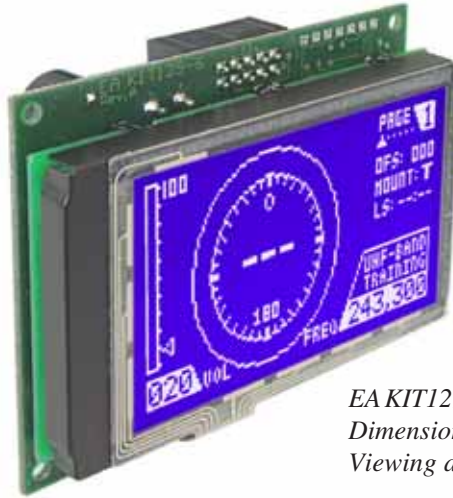

EA KIT129-6LWTP
Dimensions 75x60x24mm
Viewing area 61x 38 mm

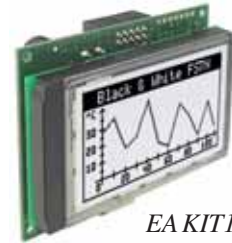

EA KIT129J-6LWTP

TECHNICAL DATA

- * LCD GRAPHIC DISPLAY WITH VARIOUS GRAPHIC FUNCTIONS AND BUILT IN FONTS
- * 128x64 PIXELS WITH LED ILLUMINATION, BLUE NEGATIVE OR BLACK AND WHITE WITH WHITE LED-BACKLIGHT
- * POWER SUPPLY 5V/170mA OR 9~35V OPTIONALLY
- * RS-232 WITH BAUD RATES 1,200..115,200 BD
- * 5 FONTS BUILT IN, EVEN WITH 90° ROTATION FOR VERTICALLY USE
- * FONT ZOOM (double size to 8-times) UP TO 35mm CHARACTER SIZE
- * POSITIONING ACCURATE TO THE PIXEL WITH ALL FUNCTIONS
- * PROGRAMMING BY MEANS OF HIGH-LEVEL LANGUAGE-TYPE COMMANDS:
- * STRAIGHT LINE, POINT, AREA, AND/OR EXOR, BAR GRAPH...
- * UP TO 256 MACROS PROGRAMMABLE
- * COMBINATION OF TEXT AND GRAPHICS ALL THE TIME
- * BUILT IN SOFTWARE SUPPORT TOUCH PANEL
- * OPERATING TEMPERATURE RANGE -20..+70°C, STORAGE -30..+70°C

ACCESSORIES

- * WITH TOUCH PANEL 5x3 AREAS (ANTI-GLARE AND SCRATCH-PROOF)
- * FLOPPY DISK FOR MACRO PROGRAMMING (PC DOS/WIN) **EA DISK240**
- * CABLE (1.5m) FOR CONNECTION TO 9-PIN SUB-D (RS-232 FEMALE) **EA KV24-9B**

ORDERING INFORMATION

128x64 WITH TOUCH PANEL 5x3, LED-B./L. BLUE-WHITE	EA KIT129-6LWTP
128x64 DOTS WITHOUT TOUCH PANEL	EA KIT129-6LW
128x64 DOTS BLACK AND WHITE WITH TOUCH PANEL	EA KIT129J-6LWTP
SUPPLY VOLTAGE 9~35VDC INSTEAD OF 5V	EA OPT-9/35V
MOUNTING BEZEL, MADE OF BLACK ANODIZED ALUMINIUM	EA 0FP129-6SW

GENERAL

The EA KIT129 graphics kit is a fully assembled control and operating unit with a variety of integrated functions. The display has very compact dimensions and offers excellent super-twist contrast, which means the unit can be put into operation immediately. It is controlled via the standard RS-232 or RS-422 interface. In addition to complete graphics routines for display output, the graphics kit also contains a wide variety of fonts. Graphics command similar to those used in high-level programming languages are used for programming. There is thus no longer any need for the time-consuming programming of character sets and graphics routines. The ease of use offered by macros and input via touch panel make it a real power display.

HARDWARE

The graphics kit is designed for an operating voltage of +5V. A supply voltage of 9..35V is also possible. Serial asynchronous data transfer is carried out in RS-232 format. The transmission format is set permanently to 8 data bits, 1 stop bits, and no parity. A transmission rate of between 1,200 and 115,200 baud can be selected by means of DIP switches. RTS and CTS handshake lines are available.

Data format:

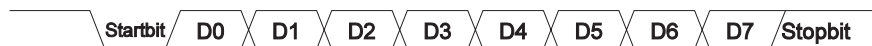

TOUCH PANEL

The EA KIT129 versions are equipped with an integrated touch panel. You can make entries and choose menu settings by touching the display. The labeling of the "keys" is flexible and can also be changed during runtime (different languages, icons). The drawing of the individual "keys" and the labeling or grouping of several fields is handled by the integrated software.

SOFTWARE

The graphic kits are programmed by means of commands such as *Draw a rectangle from (0,0) to (64, 15)*. No additional software or drivers are required. Strings can be placed with **pixel accuracy**. Text and graphics can be combined at any time. Up to 16 different character sets can be used. Thus, when the 8-times zoom is used with the largest character set (8x16), the words and numbers fill the screen (128x64).

CONTRAST ADJUSTMENT

Contrast will be adjusted via built in potentiometer. Thanks to the onboard special temperature compensation circuit there's no need for any further adjustment, even temperature changes over the whole range of -20~+70°C.

BLUE-WHITE AND BLACK&WHITE (DIFFERENCE)

The blue-white version EA KIT129-6LWTP is recommended for all indoor-applications with and without any room illumination.

The black&white FSTN-version EA KIT129J-6LWTP was specially developed for outdoor-applications. This kind of display can be read even under extrem bright sunlight conditions. It can be used without backlight also (even in direct sunlight !).

ACCESSORIES

Floppy disk for creating macros

A floppy disk (EA DISK240) is required for macro programming^{*)}. This converts the commands entered in a text file into a code that can be read by the graphics kit, and programs them into the EEPROM.

Cable for PC

To enable simple connection to PCs (macro programming), we provide a 1.5m cable and a 9-pin SUB-D female connector (EA KV24-9B). Simply insert it into COM 1 or COM 2 and get started.

^{*)} Also on the Internet: <http://www.lcd-module.de/deu/disk/disk240.zip>

ELECTRONIC ASSEMBLY

EXTERNAL KEYBOARD (EA KIT129-6LW ONLY)

A keyboard (anything from individual keys to a 3x5 matrix keyboard, J4) can be connected at the plug-in connection. The connected keys are debounced by means of software. Please note that it is only possible to connect an external keyboard to versions without an integrated touch panel.

Each key is switched between an output and an input. Each input has a 100kΩ pullup. Up to 5 keys can be connected at each output.

To find out double-key-strokes all outputs must be decoupled by a Schottky-Diode (e.g. BAT 46).

Matrix Keypad Connector J4		
Pin	Symbol	Function
1	IN 1	Input Column 1
2	OUT 1	Output Line 1
3	IN 2	Input Column 2
4	OUT 2	Output Line 2
5	IN 3	Input Column 3
6	OUT 3	Output Line 3
7	IN 4	Input Column 4
8	NC	not connected
9	IN 5	Input Column 5
10	NC	not connected

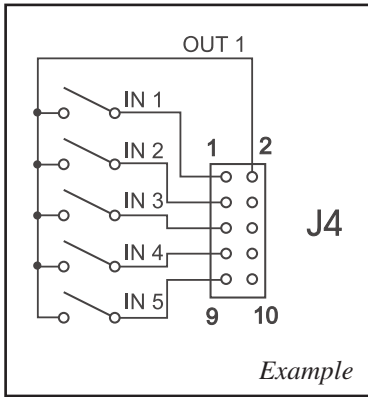

Transmitting the keystrokes

At each keystroke, the associated key number (1..15) is transmitted or an internal Touch Makro (only if defined) will be started. The release of the key is not transmitted. If the release of the key is to be transmitted as well, this can be done by defining touch macro no. 0. The automatic keyboard scan can be deactivated by means of the command "ESC T A 0". If the handshake line (e.g. CTS) does not permit transmission, keystrokes can be lost.

The key number can be determined as follows:

$$\text{Key number} = (\text{output} - 1) * 5 + \text{input}$$

(output: a number between 1 and 3; input: a number between 1 and 5).

TOUCH PANEL (EA KIT129X-LWTP ONLY)

Versions EA KIT129-6LWTP and KIT129J-6LWTP are supplied with an integrated touch panel with 15 fields. The graphics kit offers convenient commands supporting this touch panel. It is possible, for example, to group a number of touch fields to form a single large key and then draw and label the key. You can also assign a record code (1..255) to the key you have defined. If a return code of 0 is assigned, the key is disabled and has no effect when it is pressed.

When the touch keys are touched, they can be automatically inverted and a tone can sound, indicating they have been touched. At the same time, the defined return code of the key is transmitted via the serial interface, or an internal touch macro with the number of the return code is started.

Example:

Definition of a key from field 3 to 9 with the return code 65='A' and the text "STOP". Note: Before individual keys are defined, all fields should be disabled by means of "ESC T R".

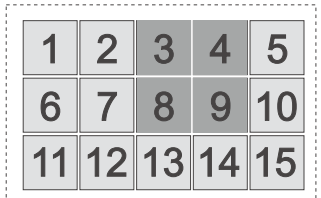

Example	Codes to be output											Note	
For compiler	#TH 11, 21, 'A', 2, "STOP"											The end code 0 is not specified here	
As ASCII	ESC	T	H	.	.	A	.	S	T	O	P	.	The dots '.' stand for ASCII characters that are not to be displayed
In hex	\$1B	\$54	\$48	\$0B	\$15	\$41	\$02	\$53	\$54	\$4F	\$50	\$00	
In decimal	27	84	72	11	21	65	2	83	84	79	80	0	
	ESC code	command for "define touch"	horizontal direction	touch count	top left	touch count	bottom right	return code	code	draw field with border			end of text

BAUD RATES

The baud rate can be set by means of the 3 DIP switches on the left. 9,600 baud is set at the factory (DIP 3 ON). Please note that the internal data buffer only holds 16 bytes. It is therefore imperative that the RTS handshake line be queried (a level of +10V means data can be accepted; a level of -10V means the display is busy). The data format is fixed at 8 data bits, 1 stop bit and no parity.

Baud rates			
DIP switches			Data format 8,N,1
1	2	3	
ON	ON	ON	1200
OFF	ON	ON	2400
ON	OFF	ON	4800
OFF	OFF	ON	9600
ON	ON	OFF	19200
OFF	ON	OFF	38400
ON	OFF	OFF	57600
OFF	OFF	OFF	115200

WRITE PROTECTION FOR PROGRAMMED MACROS

You can use DIP switch 6 to prevent the programmed macros, images and fonts from being inadvertently overwritten.

Write protection	
DIP	Write protection for EEPROM
6	
ON	On No macro progr. possible
	Off
OFF	Macro progr. possible

SUPPLY VOLTAGE / EA OPT-9/35V

In the standard model, the supply voltage of +5V is fed in via screw-type terminal J1. In the case of the version for 9..35V= (EA OPT-9/35V), the power is supplied via J1 also.

Important: It is imperative that the polarity is correct. Polarity reversal, even for a very short time, can cause the immediate destruction of the entire display.

RS-232 CONNECTION

The graphics kit is shipped with an RS-232 interface as standard. The pin assignment of the plug connector (J3) is as shown in the table on the left. The J3 has a 2.54mm grid.

The same serial data with 5V levels and CMOS logic is available at the J5 eyelet strip. These levels are suitable for direct connection to a μ C. However, if these signals are used, solder link RxD and CTS must be cut or opened.

Please note that the internal data buffer only holds 16 bytes. It is therefore imperative that the RTS handshake line be queried (a level of +10V means data can be accepted; a level of -10V means the display is busy). The data format is fixed at 8 data bits, 1 stop bit and no parity.

RS-232 J3 connection			
Pin	Symbol	In/Out	Function
1	VDD	-	+ 5V supply
2	DCD	-	Strap to DTR
3	DSR	-	Strap to DTR
4	TxD	Out	Transmit data
5	CTS	In	Clear to send
6	RxD	In	Receive data
7	RTS	Out	Request to send
8	DTR	-	See pin 2, pin 3
9	-	-	NC
10	GND	-	0V ground

Add on J5			
Pin	Symbol	In/Out	Function
1	VDD	-	+5V Supply
2	GND	-	0V, Ground
3	TxD5	Out	Transmit Data (5V)
4	RxD5	In	Receive Data (5V)
5	RTS5	Out	Request To Send (5V)
6	CTS5	In	Clear To Send (5V)
7	RESET	In	H: Reset

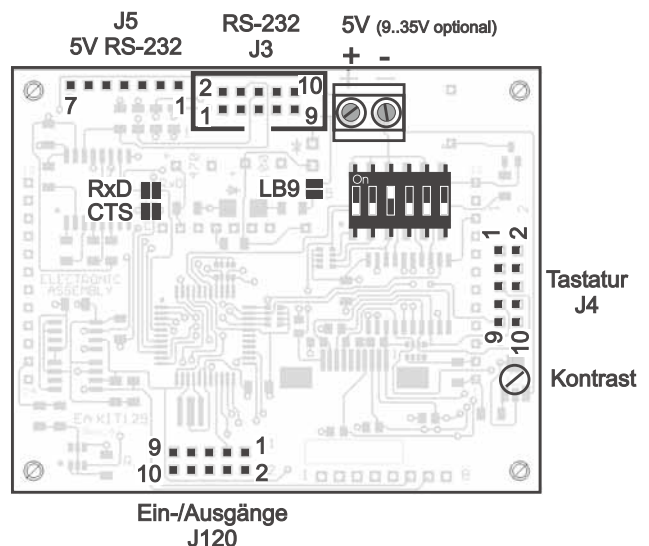

*) Also on the Internet: <http://www.lcd-module.de/deu/disk/disk240.zip>

ELECTRONIC ASSEMBLY

DIGITAL INPUTS AND OUTPUTS

EA KIT129 provides 8 digital in- or outputs (5V CMOS level, grounded). Definition for each line as an In- or Output can be done at any time. Connection will be done via J120 as a 2x5 double row pin header.

In- and Output J120					
Pin	Symbol	Function	Pin	Symbol	Function
1	VDD	+5V Supply	2	IO 1	Port 1
3	IO 2	Port 2	4	IO 3	Port 3
5	IO 4	Port 4	6	IO 5	Port 5
7	IO 6	Port 6	8	IO 7	Port 7
9	IO 8	Port 8	10	GND	0V, Ground

8 inputs

Factory-set all lines are set to input (internally pulled-up). However, the inputs will be queried and evaluated directly via the serial interface ("ESC Y R"). Additionally to that a voltage of >4V starts an internal port macro (if defined). When the 8 lines are combined, up to 256 port macros can thus be addressed. Each of these port macros can change the contents of the screen or switch an output, thus enabling a wide range of control functions. To create the port macros you need a PC and the EA DISK240 floppy disk. You will find a more detailed description on page 6. The automatic port query can be disabled by means of the "ESC Y A 0" command. **Note:** The logic circuitry is designed for slow operations; in other words, more than 3 changes per second cannot be easily executed. If an input is left open, it is logical high (internally pulled-up via 100 kOhm).

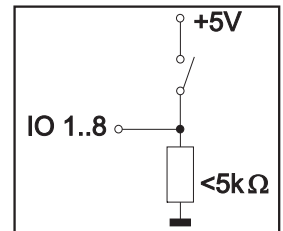
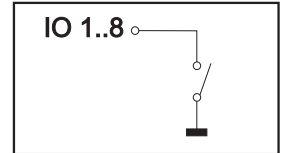

8 outputs

Writing the command "ESC Y M anz" will redefine one or more line as an output. Upper lines will be outputs and lower lines stay as inputs. Command "ESC Y M 2" for example defines IO8 and IO7 as output lines and IO1~6 will stay as inputs. Each (re-defined) line can be controlled individually using the "ESC Y W" command. A maximum current of 10mA can be switched per line. Please note that these 10mA are valid for L-level; H-level will drive some hundreds of μ A only. For more power use an external transistor or MOSFET.

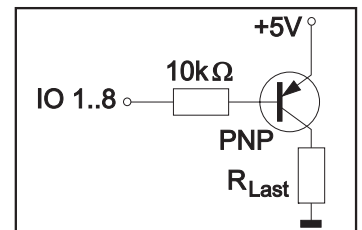
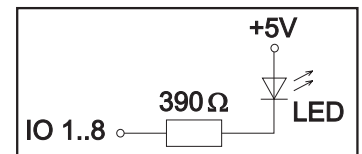

DEFAULT SETTINGS

After power-on or a manual reset, the registers shown here are set to a specific value.

Please note that all the settings can be overwritten by creating a power-on macro (normal macro no. 0).



Default settings		
Register	Command	after power-on / reset
Text mode	ESC L	set, black
Terminal font	ESC FT	Font 3, no zoom
Cursor	ESC QC	on
Flashing frequ.	ESC QZ	0.6 sec.
Graphics mode	ESC V	set
Graphics font	ESC F	Font 3, no zoom
Last xy	ESC W	(0;0)
Bargraph 1/2	ESC B	undefined / unchanged
Selekt/deselekt	ESC K	selected
I/O 1..8	ESC Y	8 inputs

MACROPROGRAMMING

Single or multiple command sequences can be grouped together in macros and stored in the EEPROM. You can then start them by using the *Execute macro* commands. There are 4 different types of macros:

Touch macros (1..255)

These are started when you touch a touch field (in versions with a touch panel - TP) or when you operate an external key/matrix keyboard. Touch macro no. 0 is different: It is started when you release any key.

Port macros (0..255)

These are started when voltage is applied to IN 1..8.

Normal macros (1..255)

These are started by means of a command via the serial interface or from another macro. A series of macros occurring one after the other can be called cyclically (movie, hourglass, multi-page help text).

Power-on macro

Normal macro no. 0 is different: It is executed automatically after power-on. It allows you to switch off the cursor and define an opening screen, for example.

Note: Programming an endless loop in Power-On-Macro makes the display non-accessible. In that case switch DIP 5 to ON position, power off, and then power on again and DIP 5 back to off position. Now all fonts and macro must be downloaded again.

STORING 256 IMAGES IN THE EEPROM

To reduce the transmission times of the serial interface or to save storage space in the processor system, up to 256 images can be stored in the internal EEPROM. They can be called using the "ESC U E" command via the serial interface or from within a touch/port/normal macro. All the images can be used in the Windows BMP format. They can be created and edit using widely available software such as Windows Paint or Photoshop.

CREATING INDIVIDUAL MACROS

To create your own macros, you need the following:

- the EA DISK240^{*)} floppy disk, which contains the compiler, examples and fonts
- a PC with a COM1 or COM2 serial interface and approximately 500KB hard disk space
- a text editor such as WordPad or Norton Editor

To define a sequence of commands as a macro, all the commands are written to a file on the PC (e.g. DEMO.KMC). You specify which character sets are to be integrated and which command sequences are to be in which macros.

Once the macros are defined, you start the program KITCOMPILER.EXE. This creates an EEPROM file called DEMO.EEP, which is then automatically stored in the display EEPROM with the baud rate entered. This only takes a few seconds, and you can then use your user-defined macros immediately. You will find a detailed description of how to program macros, together with a large number of examples, in the files DOKU.DOC (for WORD) and DOKU.TXT (DOS) on the EA DISK240^{*)} floppy disk.

WRITE PROTECTION FOR PROGRAMMED MACROS

You can use DIP switch 6 to prevent the programmed macros, images and fonts from being inadvertently overwritten (see page 4).

```
;Macro Demo
KIT129-6                ; KIT type
COM2: 115200            ; connected to COM2,
                        ; baud rate 115,200 baud
;-----
;define constants
OFF = 0
ON = 1
FONT4x6 = 1
FONT5x6 = 2
FONT6x8 = 3
FONT8x8 = 4
FONT8x16 = 5
;-----
;include fonts
Font: FONT4x6, 32, 95  INTERN4x6
Font: FONT5x6, 32, 158 INTERN5x6
Font: FONT6x8, 32, 158 INTERN6x8
Font: FONT8x8, 32, 158 INTERN8x8
Font: FONT8x16, 32, 158 INTERN8x16
;-----
Makro: 0                ; power-on/reset macro
      #QC ON            ; visible cursor
      #FT FONT8x16     ; set terminal font
      #UL 0,20,<EA2.BMP> ; ELECTRONIC ASSEMBLY logo
```

^{*)} Also on the Internet: <http://www.lcd-module.de/deu/disk/disk240.zip>

ELECTRONIC ASSEMBLY

INTEGRATED FONTS

5 character sets are integrated in each graphics unit as standard. Each character set can be used at its normal height or at up to 8 times this height. Independently of the height, the width can also be increased two to eight times.

Font 1: 4x6

+ Lower Upper	\$0 (0)	\$1 (1)	\$2 (2)	\$3 (3)	\$4 (4)	\$5 (5)	\$6 (6)	\$7 (7)	\$8 (8)	\$9 (9)	\$A (10)	\$B (11)	\$C (12)	\$D (13)	\$E (14)	\$F (15)
\$20 (dez: 32)		!	"	#	\$	%	&	'	()	*	+	,	-	.	/
\$30 (dez: 48)	0	1	2	3	4	5	6	7	8	9	:	;	<	=	>	?
\$40 (dez: 64)	@	A	B	C	D	E	F	G	H	I	J	K	L	M	N	O
\$50 (dez: 80)	P	Q	R	S	T	U	V	W	X	Y	Z	[\]	^	_

+ Lower Upper	\$0 (0)	\$1 (1)	\$2 (2)	\$3 (3)	\$4 (4)	\$5 (5)	\$6 (6)	\$7 (7)	\$8 (8)	\$9 (9)	\$A (10)	\$B (11)	\$C (12)	\$D (13)	\$E (14)	\$F (15)
\$20 (dez: 32)		!	"	#	\$	%	&	'	()	*	+	,	-	.	/
\$30 (dez: 48)	0	1	2	3	4	5	6	7	8	9	:	;	<	=	>	?
\$40 (dez: 64)	@	A	B	C	D	E	F	G	H	I	J	K	L	M	N	O
\$50 (dez: 80)	P	Q	R	S	T	U	V	W	X	Y	Z	[\]	^	_
\$60 (dez: 96)	`	a	b	c	d	e	f	g	h	i	j	k	l	m	n	o
\$70 (dez: 112)	p	q	r	s	t	u	v	w	x	y	z	{		}	~	Δ
\$80 (dez: 128)	Q	U	Š	š	Š	š	Š	š	Š	š	Š	š	Š	š	Š	š
\$90 (dez: 144)	Š	š	Š	š	Š	š	Š	š	Š	š	Š	š	Š	š	Š	š

Font 3: 6x8

Each text can be output left justified, right justified or centered. 90° rotation (for vertical installation of the display) is also possible. Macro programming permits the inclusion of up to 11 additional fonts and the complete redesign of the individual characters. A font editor on the EA DISKFONT1520 floppy disk allows you to create and program in any font you like with a size of up to 16x16 pixels.

+ Lower Upper	\$0 (0)	\$1 (1)	\$2 (2)	\$3 (3)	\$4 (4)	\$5 (5)	\$6 (6)	\$7 (7)	\$8 (8)	\$9 (9)	\$A (10)	\$B (11)	\$C (12)	\$D (13)	\$E (14)	\$F (15)
\$20 (dez: 32)		!	"	#	\$	%	&	'	()	*	+	,	-	.	/
\$30 (dez: 48)	0	1	2	3	4	5	6	7	8	9	:	;	<	=	>	?
\$40 (dez: 64)	@	A	B	C	D	E	F	G	H	I	J	K	L	M	N	O
\$50 (dez: 80)	P	Q	R	S	T	U	V	W	X	Y	Z	[\]	^	_
\$60 (dez: 96)	`	a	b	c	d	e	f	g	h	i	j	k	l	m	n	o
\$70 (dez: 112)	p	q	r	s	t	u	v	w	x	y	z	{		}	~	Δ
\$80 (dez: 128)	Q	U	Š	š	Š	š	Š	š	Š	š	Š	š	Š	š	Š	š
\$90 (dez: 144)	Š	š	Š	š	Š	š	Š	š	Š	š	Š	š	Š	š	Š	š

Font 5: 8x16

TIP: FONT EFFECTS

With large fonts, you can use the command ESC L TEXT mode (link, pattern) to produce interesting effects through overlaying (writing and offsetting a word several times).



Original font 8x16 with ZOOM 3 at position 0,0 with black pattern

"Outline font" produced by overlaying (EXOR) at pos. 1,1



Overlaying (EXOR) of the "outline font" at pos. 2,2. results in an "outline font with fill"

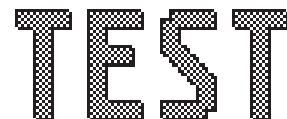

Overlaying (OR) with 50% gray pattern of the "outline font" at pos. 0,0. results in a "font with pattern fill"

ALL COMMANDS AT A GLANCE

After power-on cursor flashes at the top left of display. It is ready for some commands. All received characters will be displayed as ASCII codes (see page 7: Font 1..Font 5). Exceptions are: CR, LF, FF, ESC. Line Feed is done by code 'LF'. After screen is full, cursor will jump to top left corner again. Code 'FF' (Formfeed) will clear display.

All other commands (place cursor, set font, graphic functions, ...) will be started by ESCAPE-code (27dec. /\$1B hex).

Command table for the EA KIT129-6											
Command	Codes						Note				
Commands for terminal operation											
Form feed FF (dec:12)	^L						Deletes the screen and sets the cursor at position (1,1)				
Carriage return CR(13)	^M						Positions the cursor on the left at the beginning of the line				
Line feed LF (dec:10)	^J						Positions the cursor in the line below the current one. If the cursor is in the last line, positions it in the 1st line				
Cursor on/off	ESC	Q	C	n1			n1=0: cursor is not visible; n1=1: cursor flashes (inverse 6/10s)				
Position cursor	ESC	O	n1	n2			n1=column; n2=line; upper left origin is (1,1)				
Set terminal font	ESC	F	T	n1			n1=1: sets font no. n1 (1..16) for terminal operation				
Text output commands											
Text mode	ESC	L	n1	pat			Mode n1: 1=set; 2=delete; 3=inverse 4=replace; 5=inverse replace; pat: pattern no. 0..7				
Set font	ESC	F	n1	n2	n3		Sets font with the number n1 (1..16); n2=X- n3=Y-zoom factor (1x..8x)				
Output string horizontally	ESC	Z	L Z R	x1	y1	Text ...	NUL	Outputs a string (...) at x1,y1. 'NUL' (\$00)=end of string; lines are separated by the character ' ' (\$7C, dec:124); 'L':= left justified at x1; 'Z':= centered at x1; 'R':= right justified at x1; y1 is always the upper edge of the string			
Output string rotated by 90° (vertically)	ESC	Z	O M U	x1	y1	Text ...	NUL	Outputs a string (...) rotated by 90° at x1,y1; 'NUL' (\$00)=end; lines are separated by the character ' ' (\$7C, dec: 124); 'O':= top justified at y1; 'M':= vertically centered at y1; 'U':= bottom justified at y1; x1 is always the right edge of the string			
Drawing commands											
Graphics mode	ESC	V	n1				Sets the drawing mode for the commands 'Set point', 'Draw straight line', 'Rectangle', 'Rounded rectangle' and 'Fill area with pattern' n1: 1=set; 2=delete; 3=inverse; 4=replace; 5=inverse replace				
Set point	ESC	P	x1	y1			Sets a pixel at position x1, y1				
Draw straight line	ESC	G	x1	y1	x2	y2	Draws a straight line from x1,y1 to x2,y2				
Continue straight line	ESC	W	x1	y1			Draws a straight line from the last end point to x1, y1				
Rectangle commands											
Draw rectangle	ESC	R	R	x1	y1	x2	y2	Draws a rectangle (frame) from x1,y1 to x2,y2			
Draw rounded rectangle			N	x1	y1	x2	y2	Draws a rectangle with rounded corners from x1,y1 to x2,y2			
Delete area			L	x1	y1	x2	y2	Deletes an area from x1,y1 to x2,y2 (all pixels off)			
Invert area			I	x1	y1	x2	y2	Inverts an area from x1,y1 to x2,y2 (inverts all pixels)			
Fill area			S	x1	y1	x2	y2	Fills an area from x1,y1 to x2,y2 (all pixels on)			
Fill area with pattern			M	x1	y1	x2	y2	pat	Fills an area from x1,y1 to x2,y2 with the pattern pat (0..7)		
Draw box			O	x1	y1	x2	y2	pat	Draws a rectangle with the fill pattern pat (0..7); (always replace)		
Draw rounded box			J	x1	y1	x2	y2	pat	Draws a rectangle with the fill pattern pat (0..7); (always replace)		
Bitmap image commands											
Image from EEPROM	ESC	U	E	x1	y1	no	Loads an internal image with the number (0..255) from the EEPROM to x1,y1				
Load image			L	x1	y1	data ...	Loads an image to x1,y1; see image structure for the data of the image				
Send hard copy			H	x1	y1	x2	y2	Requests an image. Sends the width and height in pixels followed by the actual image data via RS232			

Bar graph commands													
Define bar graph	ESC	B	R L O U	no	x1	y1	x2	y2	sv	ev	pat	Defines a bar graph to the left (L), right (R), top (O) or bottom (U) with the number no (1..16). x1,y1,x2,y2 define the rectangle enclosing the bar graph. sv,ev are the values for 0% and 100%. pat=pattern (0..7)	
Draw bar graph			no	value								Sets the bar graph with the number no (1..2) to the new user 'value'	
Keyboard/touch panel commands													
Define touch key with horizontal label	ESC	T	H	f1	f2	Ret code	For	Text ...	NUL				Groups touch fields f1 to f2 (diametrically opposite corner fields) together to form a touch key with the return value 'Ret. code' (=1..255) (Ret. code=0 means the touch key is inactive). "Form": Draws touch key (=0 nothing; =1 delete; =2 with frame) "Text": Positions a string on the touch key (centered) using the current font; lines are separated by the character ' ' (\$7C, dec: 124); NUL character (\$00) = end of string
Define touch key with vertical label (rotated by 90°)				V									
(P)reset touch keys			P								Activates all touch keys in ascending order (fields with code 1..15)		
			R								Deactivates all touch keys (all fields with code 0)		
Touch key response			I	n1								n1=0: Touch key is not inverted when touched n1=1: Touch key is automatically inverted when touched	
			S	n1								n1=0: No tone sounds when (touch) key is touched n1=1: Tone sounds briefly when (touch) key is touched	
Invert touch key			M	n1								The touch key assigned the return code n1 is inverted manually	
Query key manually			W								Sends the currently depressed (touch) key at the RS-232/RS-422 interface		
Key query on/off			A	n1								The keyboard query is n1=0:deactivated; n1=1:activated, keystrokes are sent automatically; n1=2:activated, keystrokes are not sent (query with ESC T W)	
Control/definition commands													
Automatic flashing area (cursor function)	ESC	Q	D	x1	y1	x2	y2						Defines a flashing area from x1,y1 to x2,y2; activates the flashing function
			Z	n1								Sets the flashing time n1= 1..15 in 1/10s; 0=deactivates the flashing function	
			C	n1								Automatically flashing area as cursor for terminal operation n1=0: deactivates flashing function; n1=1: activates flashing function (inverse, 6/10s)	
Select/deselect	ESC	K	S	add								Activates the kit with the address n1 (n1=255: all)	
			D	add								Deactivates the kit with the address n1 (n1=255: all)	
			A	add								Assigns a new address (add) (in the power-on macro, for example)	
Wait (pause)	ESC	X	n1								Wait n1 tenths of a second before the next command is executed		
Buzzer on/off	ESC	J	n1								n1=0:tone off; n1=1:tone on; n1=2..255:for n1 1/10s long on		
Send bytes	ESC	S	num	data ...							Sends num (1..255; 0=256) bytes at the RS-232/RS-422 interface; data ... = num bytes (e.g. control of an external serial printer)		
Reset display	ESC	D	R								Resets and re-initializes the display controller		
Port commands													
Define as In- or Ouput	ESC	Y	M	n1								n1=0: I/O1..8 set to input (=default after power-on / reset) n1=1..8: n1 I/O-lines will be set to output (beginning at I/O8 downwards)	
Write output port			W	n1	n2								n1=0: Sets all 8 output ports in accordance with n2 (=8-bit binary value) n1=1..8: Resets (n2=0), sets (n2=1) or inverts (n2=2) output port n1
Read input port			R	n1								n1=0: Reads in all 8 input ports as 8-bit binary value n1=1..8: Reads in input port <n1> (1=high level=5V, 0=low level=0V)	
Port scan on/off			A	n1								Deactivates (n1=0) or activates (n1=1) automatic scanning of the input port	
Input port inverse			I	n1								Evaluates the input port (n1=0: normal; n1=1: inverted)	
Switch backlight on/off			L	n1								CFL/LED backlight n1=0: off; n1=1: on; n1=2: invert; n1=3..255: backlight for n1/10 sec. switched on and then automat. turn off	
Macro commands													
Execute macro	ESC	M	N	n1								Calls the (normal) macro with the number n1 (max. 7 levels)	
Execute touch macro			T	n1								Calls the touch macro with the number n1 (max. 7 levels)	
Execute port macro			P	n1								Calls the port macro with the number n1 (max. 7 levels)	
Macros autom. cyclical			A	n1	n2	n3						Processes macros n1..n2 automatically cyclically; n3=pause in 1/10s	
Macros autom. ping-pong			J	n1	n2	n3						Processes macros n1..n2..n1 automatically (ping-pong); n3=pause in 1/10s	
Display commands (which apply to the whole display)													
Delete display	ESC	D	L								Deletes the contents of the display (all pixels off)		
Invert display			I								Inverts the contents of the display (inverts all pixels)		
Fill display			S								Fills the contents of the display (all pixels on)		
Switch display off			A								Makes the contents of the display invisible, but they remain there and further commands are possible		
Switch display on			E								Makes the contents of the display visible again		

PARAMETERS

The graphics kit can be programmed by means of various integrated commands. Each command begins with ESC followed by one or two command letters and then parameters. All the commands and their parameters, such as coordinates and other transfer values, are always expected as bytes. No separating characters, such as spaces or commas, must be used between them. The commands require **no final byte** such as a carriage return (except for the string \$00).

A..Z, L/R/O/U All commands are transferred as ASCII characters.
Example: G= 71 (dec.) = \$47 initiates the straight-line command.

x1, x2, y1, y2 Coordinates are transferred with 1 byte.
Example: x1= 10 (dec.) = \$0A

ESC 1 byte: 27(dec.) = \$1B

n1,n2,no,sv,ev,value,pat,ret, frm,data Numerical values are transferred with 1 byte.
Example: n1=15(dec.) = \$0F

PROGRAMMINGEXAMPLE

The following table shows an example in which the string "Test" is output left justified at coordinate 7,3.

Example	Codes to be output									
	ESC	Z	L	BEL	ETX	T	e	s	t	NUL
In ASCII										
In hex	\$1B	\$5A	\$4C	\$07	\$03	\$54	\$65	\$73	\$74	\$00
In decimal	27	90	76	7	3	84	101	115	116	0
For Turbo Pascal	write(aux, chr(27), 'Z', 'L', chr(7), chr(3), 'Test', chr(0));									
For C	fprintf(stdaux, "\x1BZL%c%c%s\x00", 7, 3, "Test");									
For Q Basic	OPEN "COM1:9600,N,8,1,BIN" FOR RANDOM AS #1 PRINT #1,CHR\$(27)+"ZL"+CHR\$(7)+CHR\$(3)+"Test"+CHR\$(0)									

PATTERN

A pattern type (mst = 0..7) can be set as a parameter with some commands. In this way, rectangular areas, bar graphs and even texts can be linked to different patterns and displayed.

The following fill patterns are available:

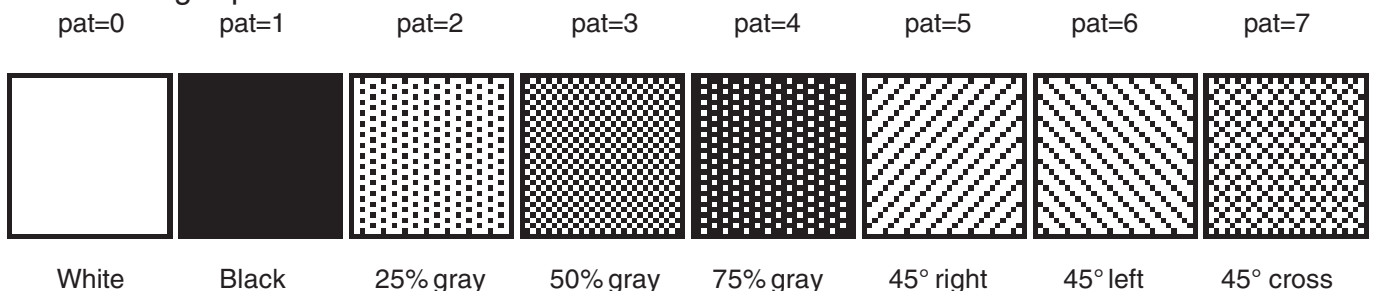

ELECTRONIC ASSEMBLY**DESCRIPTIONS OF THE VARIOUS GRAPHICS FUNCTIONS**

On the following pages you will find detailed descriptions of all of the functions in alphabetical order. In each case, an enlarged section of the image, 50x32 pixels in size, is shown as a hard copy example, indicating the contents of the display after the command is executed. The bytes to be transferred are shown as hex values in the examples.

ESC B L/R/O/U no x1 y1 x2 y2 sv ev pat**Define bar graph**

Up to 2 bar graphs (**no**=1..2) can be defined. These can extend to the left (**L**), right (**R**), up (**O**) or down (**U**). At its full extent, the bar graph occupies an area from **x1,y1** to **x2,y2**. It is scaled with the start value (no extension) **sv** (=0..254) and the end value (full extension) **ev** (=0..254). The bar graph is always drawn in inverse mode with the pattern (**pat**): The background is thus always retained. (Note: When this command is executed, it defines the bar graph but does not display it).

Example: \$1B \$42 \$4F \$01 \$04 \$02 \$09 \$1E \$04 \$14 \$01

Bar graph no. 1, which extends upwards, is defined. When it is fully extended, it takes up an area from 4,2 to 9,30. The start and end values correspond to a 4..20 mA display. (The diagram shows the bar graph fully extended, as represented with \$42 \$01 \$14.)

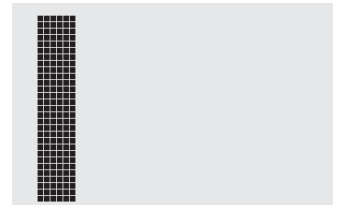
**ESC B no value****Draw bar graph**

The bar graph with the number **n1** (1..2) is set to the new value (**sv** <= **value** <= **ev**). If **value** > **ev**, the end value (**ev**) is displayed. The bar graph must be defined first (see above).

Example: \$1B \$42 \$01 \$0A

Bar graph no. 1 defined in the above example is set to a value of 10.

**ESC D L/I/S****Change contents of display**

The entire contents of the display are deleted (**L** - white), inverted (**I**) or filled (**S** - black).

Example: \$1B \$44 \$49

Inverts the entire contents of the display.

ESC D A/E**Switch display on/off**

Switches the contents of the display off (**A** - not visible) or on (**E** - visible). Outputs are still possible when it is switched off.

Example: \$1B \$44 \$41

The contents of the display are no longer visible after this command.

Note: This does not mean that power supply current is reduced.

ESC F n1 n2 n3

Sets the font with the number **n1** (1=4x6 uppercase letters only!). In addition, an enlargement factor (1..8 times) is set for the width (**n2**) and height (**n3**) separately.

Example: \$1B \$46 \$02 \$03 \$04

The 6x8 with 3 times the width and 4 times the height is set with immediate effect. In the adjacent figure, the character 'E' is shown in the 6x8 font and with various enlargement factors.

Set font

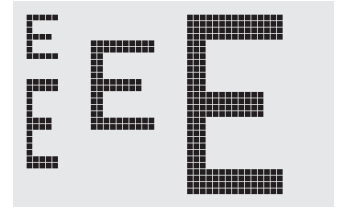

ESC F T n1

Sets the font with the number **n1** for terminal operation. The font for the terminal is always used without zoom and in REPLACE mode.

Example: \$1B \$46 \$54 \$03

The 6x8 font is set as the terminal font with immediate effect.

Set terminal font

ESC G x1 y1 x2 y2

A straight line is drawn from **x1,y1** to **x2,y2** taking into account the graphics mode set 'V' (set/delete/inverse).

Example: \$1B \$47 \$03 \$14 \$28 \$06

A straight line is drawn from 3,20 to 50,6.

Draw straight line

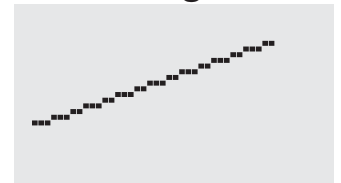

ESC H x1 y1 x2 y2

Create hard copy of display contents

Requests the area from the upper left corner (**x1,y1**) to the lower right corner (**x2,y2**). The graphics chip then immediately sends the width and height of the image section followed by the image data. See the upload image command ('U') for the structure of the image data.

Example: \$1B \$48 \$00 \$00 \$1F \$0F

The upper left part of the screen (32 x 16 pixels) is sent via RS-232.

ESC J n1

Switch beep on/off manually

Switches the tone off (**n1=0**), on for an undefined period (**n1=1**) or on for **n1/10** seconds (**n1=2..255**).

Example: \$1B \$4A \$0A

The tone sounds for 1 second after this command.

ESC K A add

Assign address

Assigns an address to the EA KIT129 (**add=0..254**). The best place for this command is in the power-on macro.

Example: \$1B \$4B \$41 \$01

The EA KIT129 is assigned the address \$01 with immediate effect.

ESC K S/Dadd

(De)select KIT129

Selects (**S**) or deselects (**D**) the EA KIT129 with the address **add** (0..254); the address 255=\$FF is a master address for all EA KIT129 units.

Example: \$1B \$4B \$44 \$01

All commands for the EA KIT129 with the address \$01 are ignored with immediate effect.

ELECTRONIC ASSEMBLY

ESC L n1 pat

Sets the link mode (**n1**) and pattern (**pat**) for the string output text function (**ESC Z**).

Example: \$1B \$4C \$03 \$03

Sets the link mode for all subsequent text functions to gray characters (pattern 3 = 50% gray) inverted with the background.

Link mode n1:

- 1 = set: black pixels irrespective of the previous value (OR)
- 2 = delete: white pixels irrespective of the previous value
- 3 = inverse: changes black pixels to white pixels and vice versa (EXOR)
- 4 = replace: deletes the background and sets black pixels
- 5 = inverse replace: fills the background and sets white pixels

Set text mode

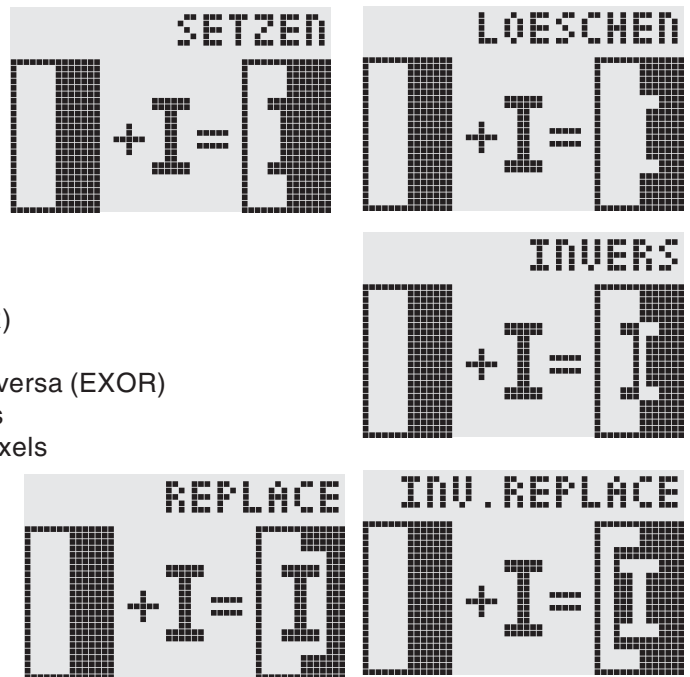

Call macro

ESC M N n1

Calls the normal macro with the number **n1** (0..255).

Example: \$1B \$4D \$4E \$0F

The (normal) macro with the number 15 is executed.

ESC M T n1

Call touch macro

Calls the touch macro with the number **n1** (0..255).

Example: \$1B \$4D \$54 \$03

The (normal) macro with the number 3 is executed.

ESC M P n1

Call port macro

Calls the port macro with the number **n1** (0..255).

Example: \$1B \$4D \$50 \$01

The (normal) macro with the number 1 is executed.

ESC M A/J n1 n2 n3

Execute macros automatically

Calls the normal macros with the numbers **n1** to **n2** automatically every **n3/10** seconds. **A**=cyclical call (e.g. 1,2,3,4,1,2,3,4, etc.); **J**=ping-pong call (e.g. 1,2,3,4,3,2,1,2,3,4, etc.).

Automatic execution is terminated:

- When a character is received from the RS-232 interface
- When a touch automatically executes a touch macro
- When an input change executes a port macro

Example: \$1B \$4D \$41 \$01 \$03 \$05

The macros with the numbers 1, 2 and 3 are executed automatically with a break of 1/2 second.

ESC O n1 n2

Position cursor

Sets the cursor to column **n1** and row **n2** for terminal operation. The origin in the upper left corner is 1,1.

Example: \$1B \$4F \$03 \$05

Sets the cursor to the 3rd column in row 5.

ESC P x1 y1

Set dot

Sets a pixel at **x1,y1** taking into account the graphics set mode 'ESC V' (set/delete/invert).

Example: \$50 \$11 \$0D

Sets the pixel at 17,13.

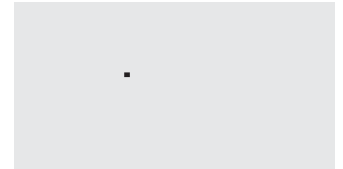

ESC Q C n1

Cursor on/off

n1=1: Switches the cursor on; it flashes at the current position on the terminal.

n1=0: Switches the cursor off.

Example: \$1B \$51 \$43 \$01

Switches the cursor off.

ESC Q D x1 y1 x2 y2

Define flashing area

Defines the area from the upper left corner (**x1,y1**) to the lower right corner (**x2,y2**) as an automatically flashing area. The flashing function is started at the same time. This deactivates the terminal cursor.

Example: \$1B \$51 \$44 \$00 \$0F \$07 \$10

Defines the flashing area from 0,15 to 7,16.

ESC Q Z n1

Set flashing time

Sets the flashing time to **n1** (=1..15) tenths of a second. When **n1=0**, the flashing function is deactivated and the original screen restored.

Example: \$1B \$51 \$5A \$03

Sets the flashing time to 0.3 seconds.

ESC R R x1 y1 x2 y2

Draw rectangle

Draws a rectangle from the upper left corner (**x1,y1**) to the lower right corner (**x2,y2**) taking into account the set graphics mode 'V' (set/delete/inverse). The contents of the rectangle are not changed. See 'ESC R O' (Draw box).

Example: \$1B \$52 \$52 \$15 \$08 \$30 \$25

Draws a rectangle from 21,8 to 48,37.

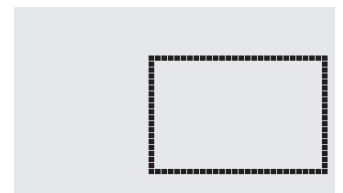

ESC R N x1 y1 x2 y2

Draw rounded rectangle

Draws a rectangle with rounded corners from the upper left corner (**x1,y1**) to the lower right corner (**x2,y2**) taking into account the set graphics mode 'V' (set/delete/inverse). The contents of the rounded rectangle are not changed. See 'ESC R J' (Draw rounded box).

Example: \$1B \$52 \$4E \$06 \$02 \$26 \$13

Draws a rounded rectangle from 6,2 to 38,19.

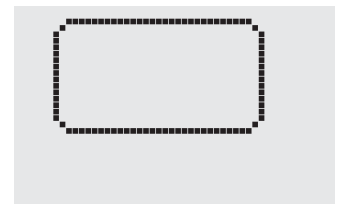

ELECTRONIC ASSEMBLY

ESC R L x1 y1 x2 y2

Deletes the area from the upper left corner (**x1,y1**) to the lower right corner (**x2,y2**).

Example: \$1B \$44 \$53 \$1B \$52 \$4C \$06 \$04 \$28 \$19

The display is filled with **ESC D S** and then deleted from 6,4 to 40,25.

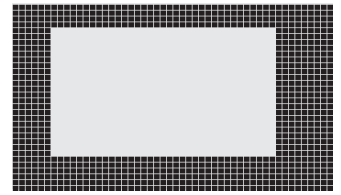
Delete area**ESC R I x1 y1 x2 y2**

Inverts the area from the upper left corner (**x1,y1**) to the lower right corner (**x2,y2**) (black pixels turn white and vice versa).

Example: \$1B \$52 \$49 \$00 \$00 \$17 \$1B

Inverts the area from 0,0 to 23,27 with the display contents from the "Set font" example.

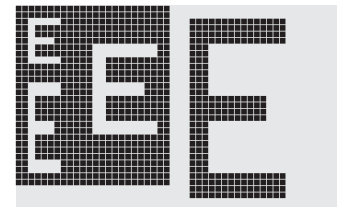
Invert area**ESC R S x1 y1 x2 y2**

Fills the area from the upper left corner (**x1,y1**) to the lower right corner (**x2,y2**) (sets the pixels to black).

Example: \$1B \$52 \$53 \$09 \$05 \$16 \$16

Sets the area from 9,5 to 22,22 black.

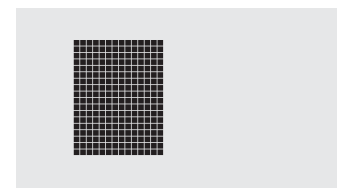
Fill area**ESC R M x1 y1 x2 y2 pat**

Fills a rectangular area from the upper left corner (**x1,y1**) to the lower right corner (**x2,y2**) with the pattern **pat** taking into account the set graphics mode "ESC V" (set/delete/invert/replace/inverse replace).

Example: \$1B \$52 \$4D \$05 \$01 \$2D \$1A \$07

Fills the area with the pattern 7=45°cross from 5,1 to 45,26.

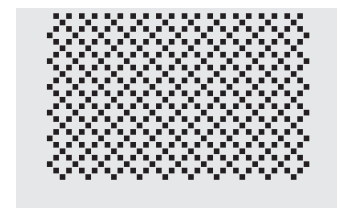
Fill area with pattern**ESC R O x1 y1 x2 y2 pat**

Draws a rectangle from the upper left corner (**x1,y1**) to the lower right corner (**x2,y2**) with the pattern **pat**. The background of the box is deleted. See 'ESC R R' (Draw rectangle).

Example: \$1B \$52 \$4F \$02 \$05 \$12 \$1E \$02

Draws a box from 2,5 to 18,30 with the pattern 2=25%gray.

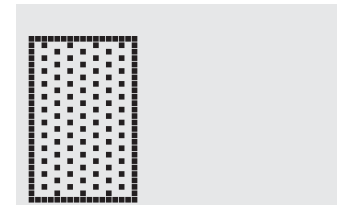
Draw box**ESC R J x1 y1 x2 y2 pat**

Draws a rectangle with rounded corners from the upper left corner (**x1,y1**) to the lower right corner (**x2,y2**) with the pattern **pat**. The background is deleted. See 'ESC R N' (Draw rounded rectangle).

Example: \$1B \$52 \$4A \$07 \$03 \$23 \$16 \$03

Draws a rounded box from 7,3 to 35,22 with the pattern 3=50%gray.

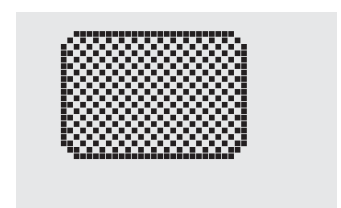
Draw rounded box**ESC S num data...**

Outputs the next **num** (1..255, 0=256) bytes at the serial interface.

Example: \$1B \$53 \$04 \$54 \$45 \$53 \$54

Transmits the word 'TEST' via the RS-232C interface.

Send bytes via RS-232

ESC T H/Vf1 f2 ret frm text... NUL Define touch key

Defines a touch key and labels it with the current font. **H**=horizontal or **V**=vertical labeling (rotated 90°). Several touch fields can be grouped together to form a single touch key (**f1**=upper left touch field; **f2**=lower right touch field of the new touch key). This touch key is assigned a return code with **ret** (1..255). When the touch key is touched, the touch macro with the number **ret** is called or, if no touch macro is defined, this return code is sent via the RS232. You use **frm** to define the format of the touch key (frm=0: don't draw anything; frm=1: delete touch key; frm=2: delete touch key and draw with frame). **text...**=string with the label (which is always centered on the touch key). The label can also have more than one line; in this case, the lines are separated by the pipe-character '|' (= \$7C). The string must be concluded with **NUL**= \$00. See example on page 3.

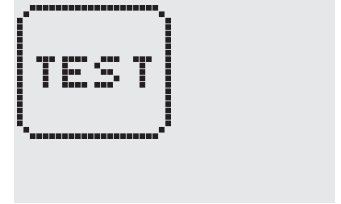

Example 1: Horizontal touch key:

\$1B \$54 \$48 \$01 \$01 \$41 \$02 \$54 \$45 \$53 \$54 \$00

Defines a horizontal touch key (field no. 1 only) with the return code 65='A'. The touch key is drawn with a frame and labeled with the word 'TEST'.

Example 2: Vertical touch key:

\$1B \$54 \$56 \$02 \$02 \$42 \$02 \$54 \$45 \$53 \$54 \$00

Defines a vertical touch key (touch field no. 2 only) with the return code 66='B'. The touch key is drawn with a frame and labeled with the word 'TEST'.

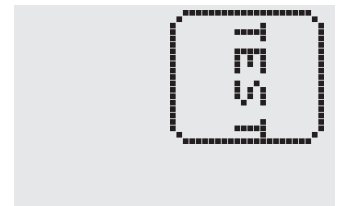

ESC T P/R Preset/reset touch fields

Assigns **P** (=ascending return code: 1..60) or **R** (=reset all touch fields) to all 60 touch fields. In the latter case all touch fields receive the return code 0 (i.e. they are deactivated).

Example: \$1B \$54 \$52

All touch fields are deactivated by this command and no longer recognized.

ESC T I/S n1 Touch key response

These commands set the automatic response of the touch panel to touching. Both responses can be activated simultaneously.

I=automatic inversion when the touch key is touched (**n1**=0: off or **n1**=1: on)

S=automatic signal tone when the touch key is touched (**n1**=0: off or **n1**=1: on)

Example: \$1B \$54 \$49 \$01

After this command the tone sounds when a touch key is touched.

ESC T M ret Invert touch key manually

This command manually inverts the touch key with the return code **ret**.

Example: \$1B \$54 \$4D \$41

Inverts the touch key from the above example with the return code 65='A'.

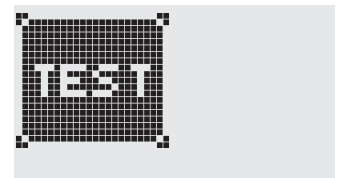

ESC T A n1 (Touch) key query on/off

This command sets the (touch) key query:

n1=0: Switches the key query off - no touch macros or manual key query possible.

n1=1: Activates the key query - keystrokes trigger touch macros or are sent via RS232.

n1=2: Activates the key query - keystrokes trigger touch macros; must be queried manually.

Example: \$1B \$54 \$41 \$02

Activates the (touch) key query. The keystrokes are not sent automatically via RS232; they have to be requested manually by means of the command **ESC T W**.

ESC T W Query touch key manually

Sends the return code of the currently depressed touch key at the RS232.

Example: \$1B \$54 \$57

ELECTRONIC ASSEMBLY

ESC U E x1 y1 n1

Displays the image saved in the EEPROM with the number **n1** (0..255) at position **x1,y1**.

Example: \$1B \$55 \$45 \$02 \$03 \$0E

Displays image number 14 from the EEPROM at position 2,3.

ESC U L x1 y1 data...

Displays an image at position **x1,y1**.

data..:

- 1 byte for the image width in pixels
- 1 byte for the image height in pixels
- Image data: number = ((height+7) / 8) * width bytes

1 byte stands for 8 horizontal pixels on the screen; 0=white, 1=black;
LSB: top, MSB: bottom; the image is stored from left to right.

The BMP2BLV.EXE program on the EA DISK240 floppy disk available as an accessory creates the image data, including the width and height, from monochrome Windows bitmap graphics (*.BMP).

Example:

```
$1B $55 $4C $09 $04 $0C $0C
$F0 $FC $FE $FE $F7 $BF $BF $F7 $FE $FE $FC $F0
$00 $03 $07 $06 $0D $0D $0D $0D $06 $07 $03 $00
```

Loads the adjacent image at position 9,4.

ESC V n1

Sets the link mode **n1** for the following graphics functions: ESC P (Set point), ESC G (Draw straight line), ESC W (Continue straight line), ESC R R (Draw rectangle), ESC R N (Draw rounded rectangle), ESC R M (Fill area with pattern).

Example: \$1B \$56 \$03

Sets the link mode to inverse.

By way of example, a rectangle is drawn alongside with the link modes set, delete and inverse on an existing background.

Link mode n1:

- 1 = set: black pixels irrespective of the previous value (OR)
- 2 = delete: white pixels irrespective of the previous value
- 3 = inverse: changes black pixels to white pixels and vice versa (EXOR)
- 4 = replace: deletes the background and sets black dots; only area with fill pattern 'pat'
- 5 = inverse replace: fills the background and sets white pixels; only area with fill pattern 'pat'

ESC W x1 y1

Continues a straight line from the last end or point drawn to **x1,y1** taking into account the set graphics mode 'V'.

Example:

```
$1B $47 $00 $00 $10 $04
$1B $57 $16 $1B
$1B $57 $30 $0F
```

A straight line is drawn from 0,0 to 16,4. It is then continued to 22,27 and to 48,15.

Load image from EEPROM

Upload image

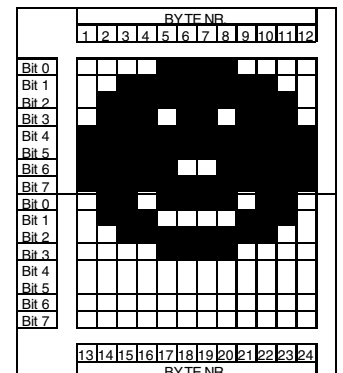
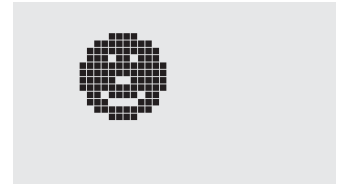

Set graphics mode

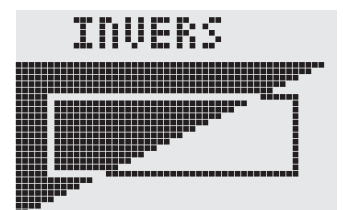
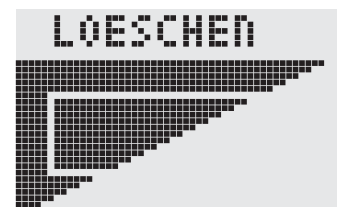
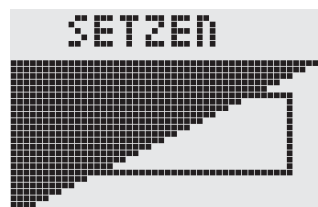

Continue straight line

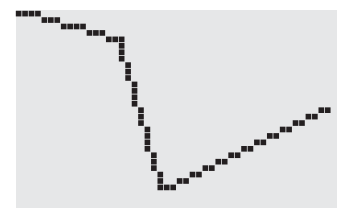

ESC X n1

Wait/pause

This command suspends the EA KIT129 for $n1/10$ seconds.

Example: \$1B \$58 \$0A

After this command the EA KIT129 waits for a second before the next command is processed.

ESC Y M n1

Define as an output

$n1$ =count of I/O lines will be defined as an output (starting at I/O8 downwards).

If $n1=0$, all lines I/O1~I/O8 are switched as input lines (=default after power-on and after reset); see also application page 5.

Example: \$1B \$59 \$4D \$03

sets I/O lines 6, 7 and 8 as output. I/O lines 1,2,3,4,5 stay as input lines.

ESC Y R n1

Read input port

Reads in the input port ($n1=1..8 = I/O1 \dots I/O8$). When $n1=0$, all the inputs are read in as 8-bit binary values (MSB:I/O8 ... I/O1:LSB); see application on page 5. Important: External optocoupler device usually invert the input logic (input open: 1). The command "ESC Y I 1" puts this right (input open: 0).

Example: \$1B \$59 \$52 \$03

Reads in port I/O3. The result is sent via RS232.

ESC Y W n1 n2

Write output port

Changes the output port ($n1=1..8 = I/O1 \dots I/O8$) to the value $n2$ (0=low level; 1=high level; 2=invert port). When $n1=0$, all the outputs are output as a binary value $n2$ (MSB:I/O8 ... I/O1:LSB); see application on page 5.

Example: \$1B \$59 \$57 \$02 \$01

Switches the output port I/O2 to high level.

ESC Y A n1

Automatic port query on/off

Each change at the input port (8-bit binary value I/O8 ... I/O1) can call a port macro (0..255). This command activates ($n1=1$) or deactivates ($n1=0$) the automatic port query. After power-on, the current port status is read and the associated port macro executed immediately.

Example: \$1B \$59 \$41 \$01

Activates the automatic port query and executes the associated port macro.

ESC Y I n1

Invert input port logic

This command allows the logic of the input port to be inverted ($n1=0$ for normal or $n1=1$ for inverse). This is useful with the external optocoupler devices, for example.

Example: \$1B \$59 \$49 \$01

Inverts the input port logic.

ESC Y L n1

Switch LED-Backlight on/off

$n1=0$ will switch off LED backlight, $n1=1$ will switch on backlight; $n1=2$ inverts: ON->OFF or OFF->ON; $n1=3..255$ LED backlight switched on for the time of $n1/10$ seconds.

Example:

\$1B \$4A \$64

will switch on backlight for 10 seconds.

Note: In blue version EA KIT129-LW(TP) backlight will be driven with 7mA even in "backlight-off" state. This is necessary to keep a minimum of contrast. If required, these stand-by backlight can be switched to real zero when resistor R_{off} (240Ω, SMD type) is removed.

Black&white-version EA KIT129J-LW(TP) do not have this LED stand-by current.

ELECTRONIC ASSEMBLY

ESC Z L/Z/R x1 y1 text... NUL

Writes the string **text...** left justified (**L**), centered (**Z**) or right justified (**R**) at position **x1** taking into account the set text mode (**ESC L**). Multi-line text can also be output, with the lines separated by the character '|' (**=\$7C**). The string must be concluded with **NUL= \$00**. Position **y1** is the upper edge of the 1st line.

Example 1: Writes the text "Left|Ok" left justified at 0,0.
 \$1B \$5A \$4C \$00 \$00 \$4C \$65 \$66 \$74 \$7C \$4F \$6B \$00

Example 2: Writes the text "Center|Ok" centered at 25,0.
 \$1B \$5A \$5A \$19 \$00 \$43 \$65 \$6E \$74 \$65 \$72 \$7C \$4F \$6B \$00

Example 3: Writes the text "Right|Ok" right justified at 49,0.
 \$1B \$5A \$52 \$31 \$00 \$52 \$69 \$67 \$68 \$74 \$7C \$4F \$6B \$00

Horizontal string



ESC Z O/M/U x1 y1 text... NUL

Writes the string **text...** rotated by 90° degrees top justified (**O**), vertically centered (**M**) or bottom justified (**U**) at position **y1** taking into account the text mode (**ESC L**). Multi-line text can also be output, with the lines separated by the character '|' (**=\$7C**). The string must be concluded with **NUL= \$00**. Position **x1** is the right edge of the 1st line.

Example 1: Writes the text "Top|Ok" top justified at 49,0.
 \$1B \$5A \$4F \$31 \$00 \$54 \$6F \$70 \$7C \$4F \$6B \$00

Example 2: Writes the text "Mid|Ok" vertically centered at 49,15.
 \$1B \$5A \$4D \$31 \$0F \$4D \$69 \$64 \$7C \$4F \$6B \$00

Example 3: Writes the text "Bot|Ok" bottom justified at 49,31.
 \$1B \$5A \$55 \$31 \$1F \$42 \$6F \$74 \$7C \$4F \$6B \$00

Vertical string

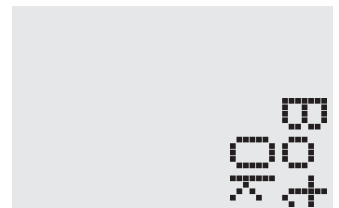
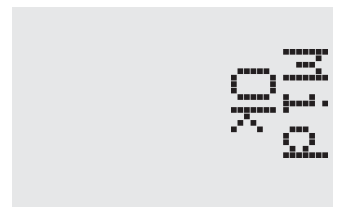
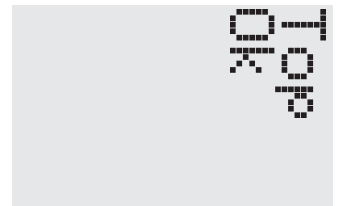

EA KIT129-6

DIMENSIONS

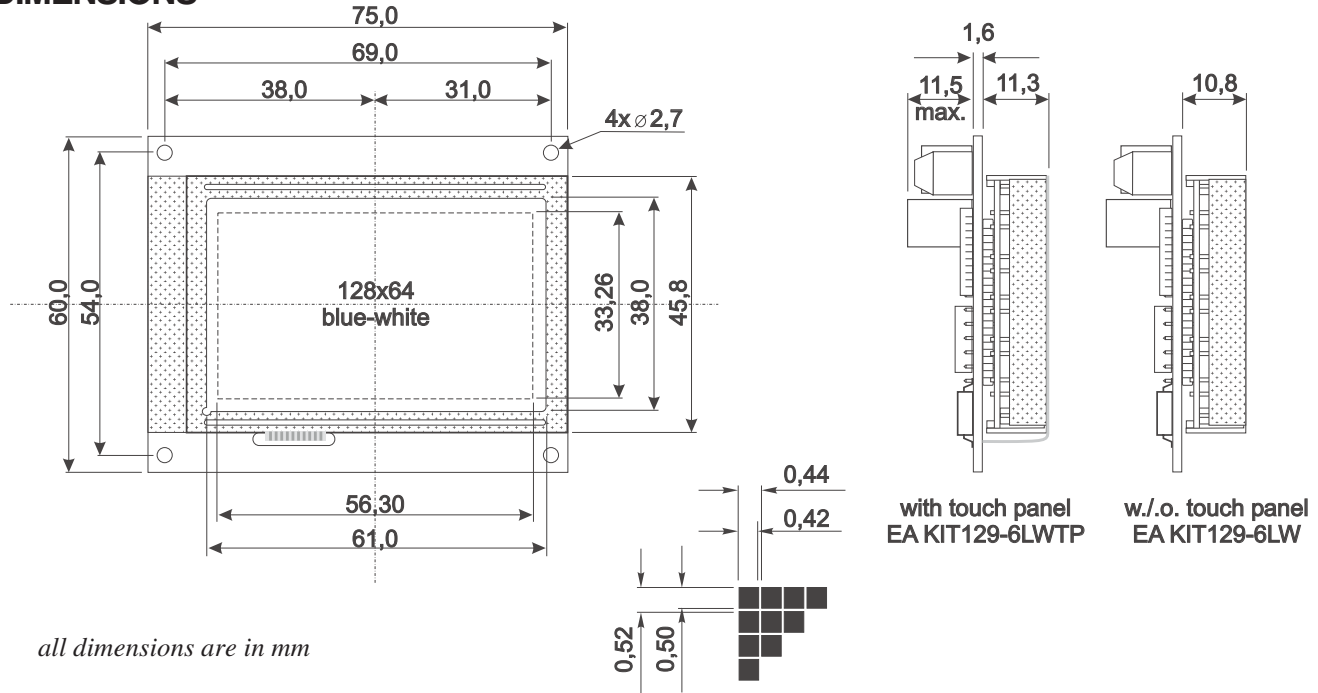

MOUNTING BEZEL

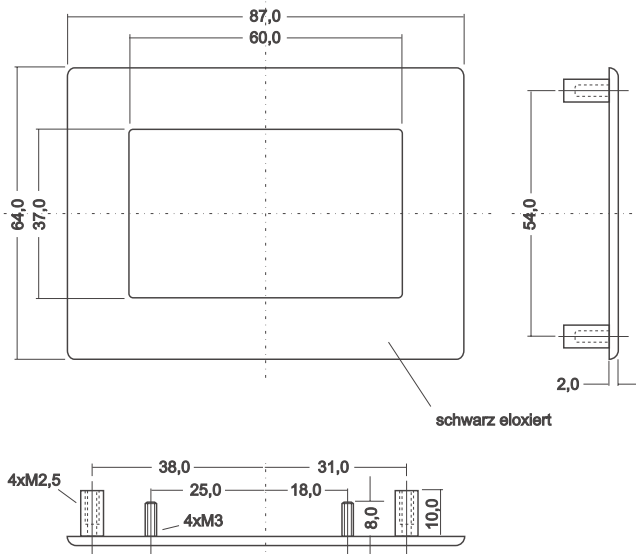

CUT OUT

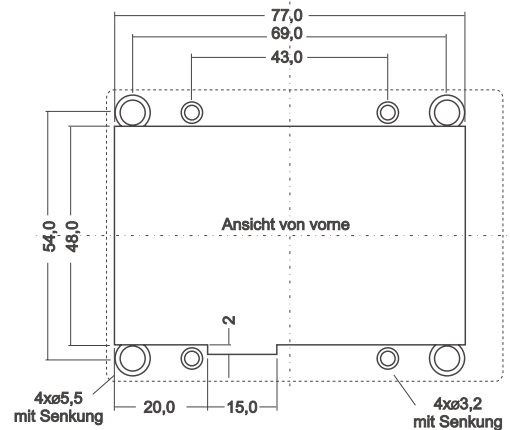

all dimensions are in mm

HINTS FOR HANDLING AND OPERATING

- The module can be destroyed electrically by mispoled or overvoltaged power supply, wrong polarity, overvoltage or static discharge on inputs or shortened outputs.
- Before disassembling the module, the power supply must be switched off. Also all inputs must not carry any current.
- Display, touch screen and cover glass are scratch- sensitive plastic materials and should not be touched with hard objects.
- Surfaces should be cleaned with soft fabric without using of chemical solvents.
- The module is designed for indoor use only. For operating in outside enviroment adequate precautions must be undertaken. Maximum operating temperature range from -20..+70°C should be not exceeded. Please note that ambient temperature range is different because of self-heating of module. In humid atmosphere or in condensing situations the module functions may drop out. Direct sun exposure to the display should be avoided. Storage temperature range is -30..+70°C.



Компания «Life Electronics» занимается поставками электронных компонентов импортного и отечественного производства от производителей и со складов крупных дистрибьюторов Европы, Америки и Азии.

С конца 2013 года компания активно расширяет линейку поставок компонентов по направлению коаксиальный кабель, кварцевые генераторы и конденсаторы (керамические, пленочные, электролитические), за счёт заключения дистрибьюторских договоров

Мы предлагаем:

- Конкурентоспособные цены и скидки постоянным клиентам.
- Специальные условия для постоянных клиентов.
- Подбор аналогов.
- Поставку компонентов в любых объемах, удовлетворяющих вашим потребностям.
- Приемлемые сроки поставки, возможна ускоренная поставка.
- Доставку товара в любую точку России и стран СНГ.
- Комплексную поставку.
- Работу по проектам и поставку образцов.
- Формирование склада под заказчика.
- Сертификаты соответствия на поставляемую продукцию (по желанию клиента).
- Тестирование поставляемой продукции.
- Поставку компонентов, требующих военную и космическую приемку.
- Входной контроль качества.
- Наличие сертификата ISO.

В составе нашей компании организован Конструкторский отдел, призванный помогать разработчикам, и инженерам.

Конструкторский отдел помогает осуществить:

- Регистрацию проекта у производителя компонентов.
- Техническую поддержку проекта.
- Защиту от снятия компонента с производства.
- Оценку стоимости проекта по компонентам.
- Изготовление тестовой платы монтаж и пусконаладочные работы.



Тел: +7 (812) 336 43 04 (многоканальный)

Email: org@lifeelectronics.ru