

ULTRA HIGH SPEED SINGLE OPERATIONAL AMPLIFIER

■ GENERAL DESCRIPTION

The **NJM2710** is an ultra high speed hex operational amplifier.

It can swings $260V/\mu s$ high slew rate and 1GHz gain band width product(10MHz typ. at 40dB) at 5V.

It is suitable for telecommunication related system, digital broadcasting system, high quality scanner and any other high speed signal processing system.

■ PACKAGR OUTLINE

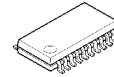

NJM2710M



NJM2710V

■ FEATURES

- Operating Voltage $(\pm 2.0$ to $\pm 4.5V)$
- Operating Current $(11.4mA$ typ. at $V^+/V^-=\pm 2.5V)$
- High Slew Rate $(260V/\mu s$ typ.)
- Gain Bandwidth Product $(1GHz$ typ.)
- Bandwidth $(10MHz$ typ. at 40dB)
- Unity Gain Bandwidth $(180MHz$ typ.)
- Input Offset Voltage $(7mV$ max.)
- Maximum Output Voltage $(\pm 1.5V$ typ. at $R_L=1k\Omega)$
- Open Loop Voltage Gain $(75dB$ typ.)
- Bipolar Technology
- Package Outline DMP20,SSOP20

■ PIN CONFIGURATION

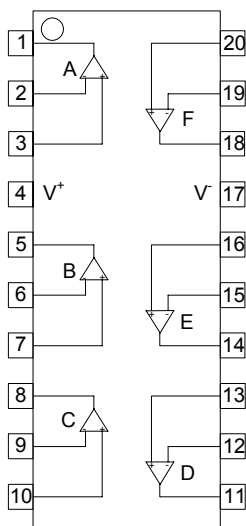

NJM2710E
NJM2710V
(TOP VIEW)

Pin Function

- | | |
|--------------|--------------|
| 1. A OUTPUT | 11. D OUTPUT |
| 2. A -INPUT | 12. D -INPUT |
| 3. A +INPUT | 13. D +INPUT |
| 4. V^+ | 14. E OUTPUT |
| 5. B OUTPUT | 15. E -INPUT |
| 6. B -INPUT | 16. E +INPUT |
| 7. B +INPUT | 17. V^- |
| 8. C OUTPUT | 18. F OUTPUT |
| 9. C -INPUT | 19. F -INPUT |
| 10. C +INPUT | 20. F +INPUT |

NJM2710

■ ABSOLUTE MAXIMUM RATINGS

(Ta=25°C)

PARAMETER	SYMBOL	RATINGS	UNIT
Supply Voltage	V ⁺	10	V
Differential Input Voltage	V _{ID}	±2	V
Power Dissipation	P _D	(DMP20,SSOP20)375	mW
Operating Temperature Range	T _{opr}	-40 to +85	°C
Storage Temperature Range	T _{stg}	-50 to +150	°C

■ DC CHARACTERISTICS

(V⁺/V⁻=±2.5V, Ta=25°C)

PARAMETER	SYMBOL	TEST CONDITION	MIN	TYP	MAX	UNIT
Operating Voltage Range	V ⁺ /V ⁻		2.0	2.5	4.5	V
Operating Current	I _{CC}	No Signal	-	11.4	20.4	mA
Input Offset Voltage	V _{IO}		-	2.0	7.0	mV
Input Bias Current	I _B		-	2	7	μA
Input Offset Current	I _{IO}		-	350	900	nA
Open Loop Voltage Gain	A _v	R _L =2kΩ	65	75	-	dB
Input Common Mode Voltage Range	V _{ICM}		±1.3	±1.5	-	V
Common Mode Rejection	CMR	-1V≤V _{CM} ≤+1V	50	60	-	dB
Supply Voltage Rejection	+SVR	2.5V≤V ⁺ ≤5V, R _L =2kΩ	50	60	-	dB
	-SVR	-5V≤V ⁻ ≤-2.5V, R _L =2kΩ	50	60	-	dB
Maximum Output Voltage	V _{OM}	R _L =1kΩ	±1.2	±1.5	-	V

■ AC CHARACTERISTICS

(V⁺/V⁻=±2.5V, Ta=25°C)

PARAMETER	SYMBOL	TEST CONDITION	MIN	TYP	MAX	UNIT
Bandwidth	BW	A _v =40dB, R _f =1.98kΩ, R _L =∞ C _L =10pF	-	10	-	MHz
Unity Gain Bandwidth	f _T	A _v =40dB, R _g =20Ω, R _f =1.98kΩ R _L =∞, C _L =10pF	-	180	-	MHz
Phase Margin	φ _M	A _v =40dB, R _g =20Ω, R _f =1.98kΩ R _L =∞, C _L =10pF	-	38	-	deg
Equivalent Input Noise Voltage	V _{NO}		-	6.8	-	nV/√Hz

■ TRANSIENT CHARACTERISTICS

(V⁺/V⁻=±2.5V, Ta=25°C)

PARAMETER	SYMBOL	TEST CONDITION	MIN	TYP	MAX	UNIT
Slew Rate	+SR	A _v =6dB, R _f =1kΩ, R _g =1kΩ	-	260	-	V/μs
	-SR	R _L =∞, C _L =10pF	-	260	-	V/μs

■ Note:

non-inverting amplifier

1. The closed gain should be 6dB or higher to prevent the oscillation.
Unity gain follower application may cause the oscillation.
2. When the closed gain is lower than 20dB, use a compensation capacitor (CF: about 5pF), parallel with the feedback resistor RF to avoid oscillation.
3. Recommended feedback resistor is less than 2kΩ to keep the flatness of the frequency response.
4. Minimize the load capacitor for the better performance.
A large load capacitor CL reduces the frequency response and causes oscillation or ringing.

inverting amplifier

1. When the closed gain is lower than 20dB, use a compensation capacitor (CF; recommended from 1pF to 5pF), parallel with the feedback resistor RF to avoid oscillation.
2. Minimize the feedback resistor to keep the frequency response and the slew rate.
(recommended about 1k-ohm)
The proper compensation capacitor CF can counteract oscillation even with a large feedback resistor RF.
3. Total load capacitance should be not more than 100pF.
The oscillation margin may be affected by the total load capacitance.

non-inverting amplifier

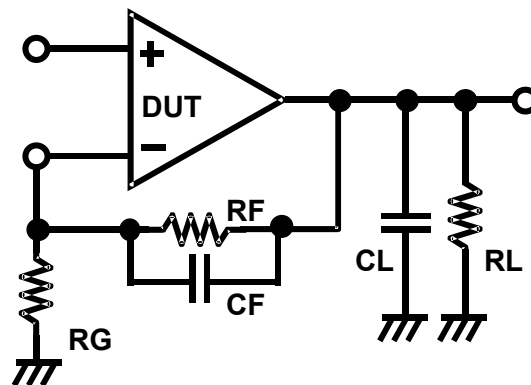

inverting amplifier

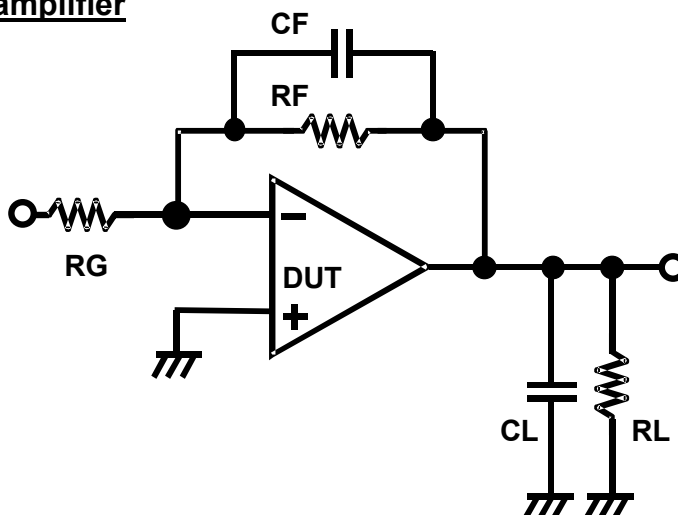

■ TYPICAL CHARACTERISTICS

Supply Current vs. Supply Voltage

V_{IN} =No Signal, G_V =6dB, R_S =50 Ω
 R_F =1k Ω , R_G =1k Ω , R_L =2k Ω , T_a =+25 $^{\circ}$ C

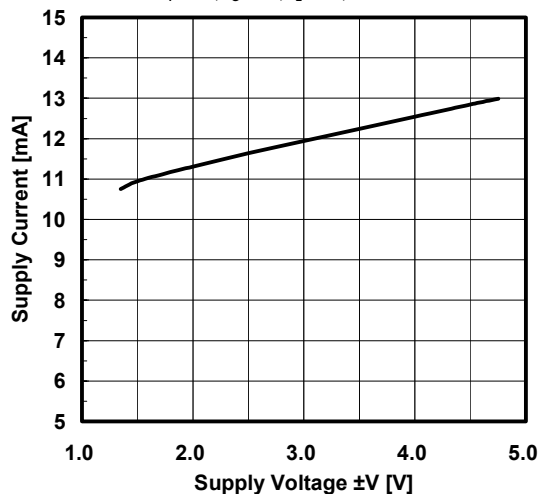

Supply Current vs. Ambient Temperature

V^*/V = \pm 2.5V, V_{IN} =No Signal, G_V =6dB
 R_S =50 Ω , R_F =1k Ω , R_G =1k Ω , R_L =2k Ω

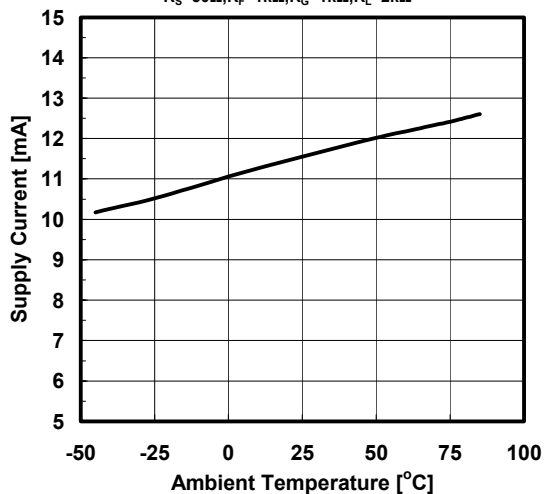

Input Offset Voltage vs. Ambient Temperature

V^*/V =2.5V

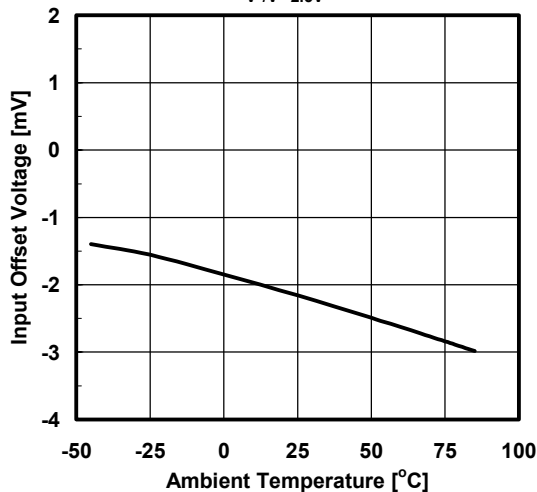

Input Bias Current vs. Ambient Temperature

V^*/V =2.5V

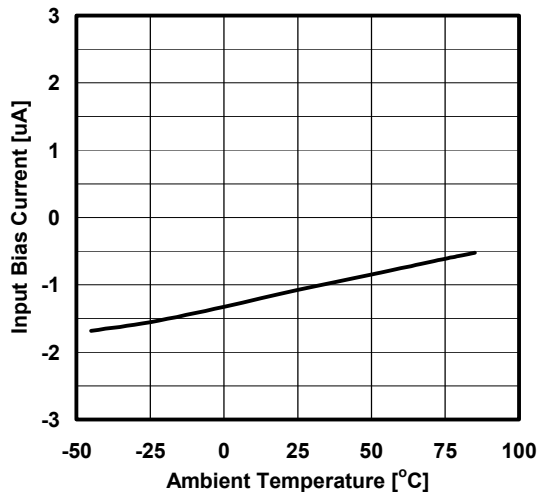

Input Offset Current vs. Ambient Temperature

V^*/V =2.5V

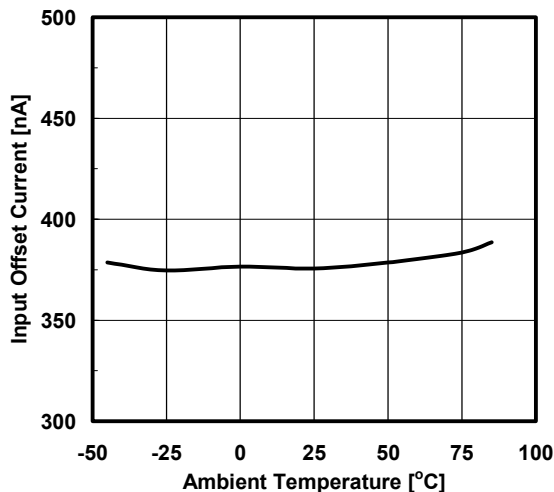

Common Mode Rejection Ratio vs. Ambient Temperature

V^*/V =2.5V

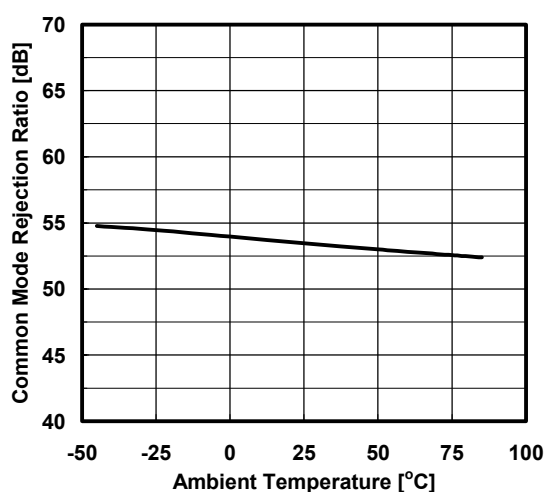

■ TYPICAL CHARACTERISTICS

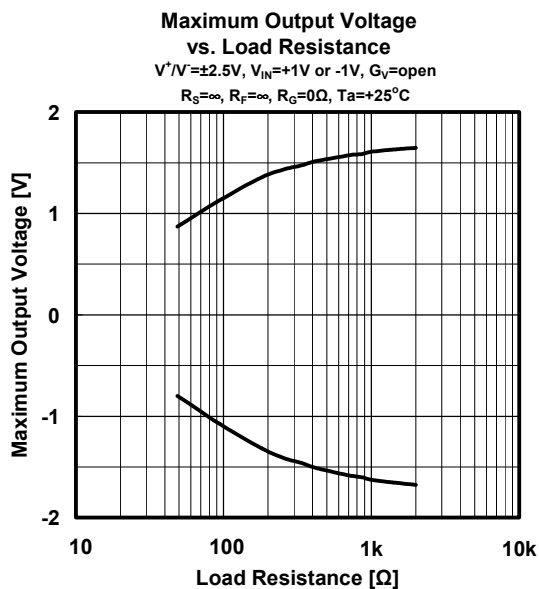
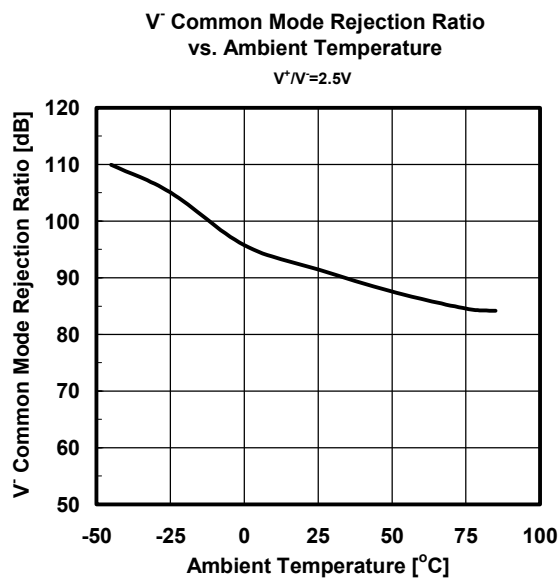
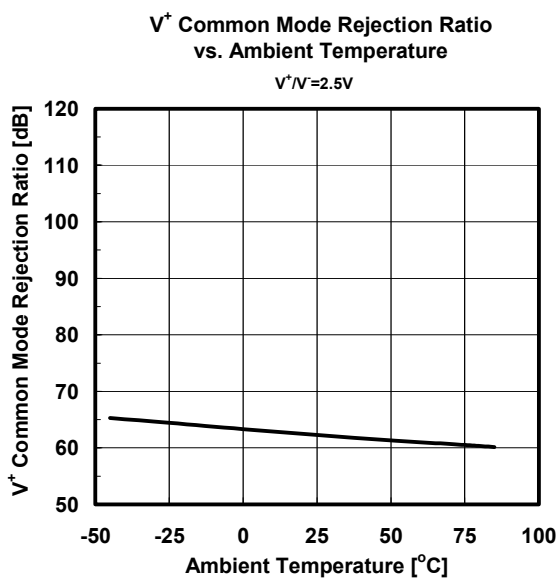

TYPICAL CHARACTERISTICS

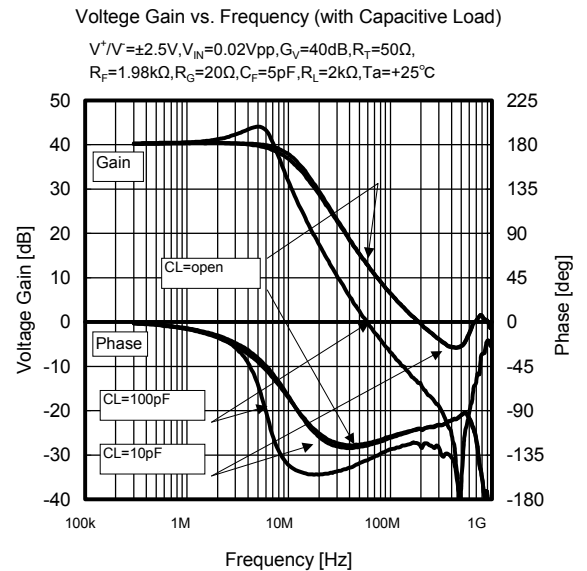
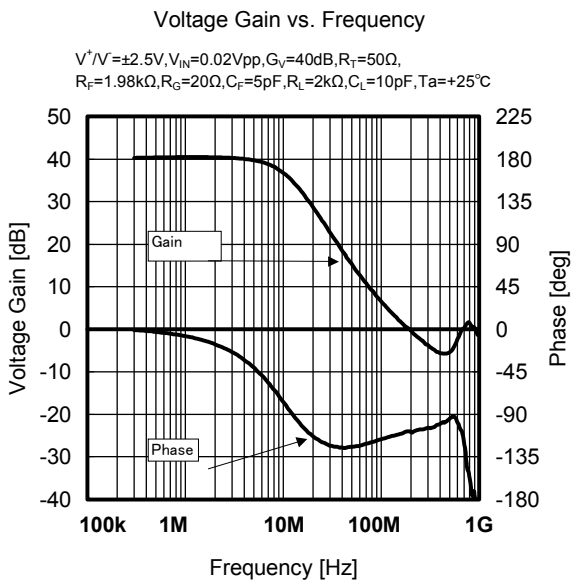
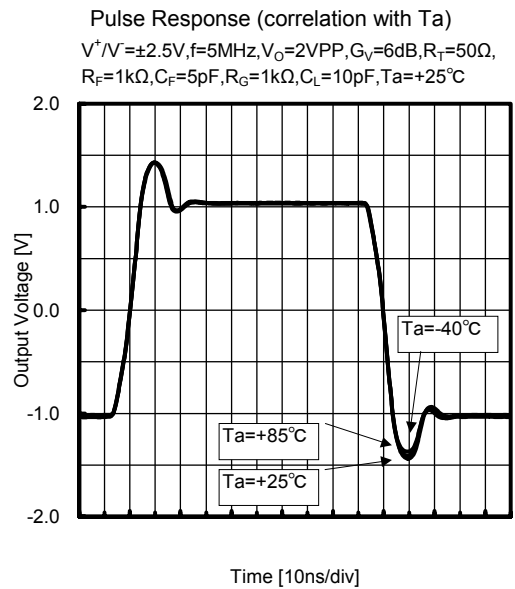
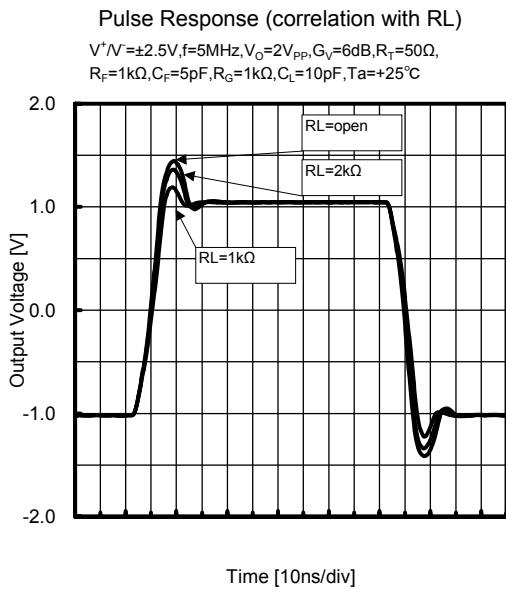
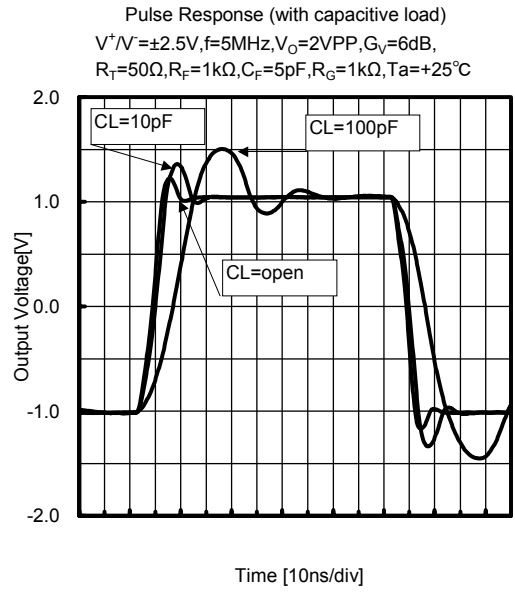
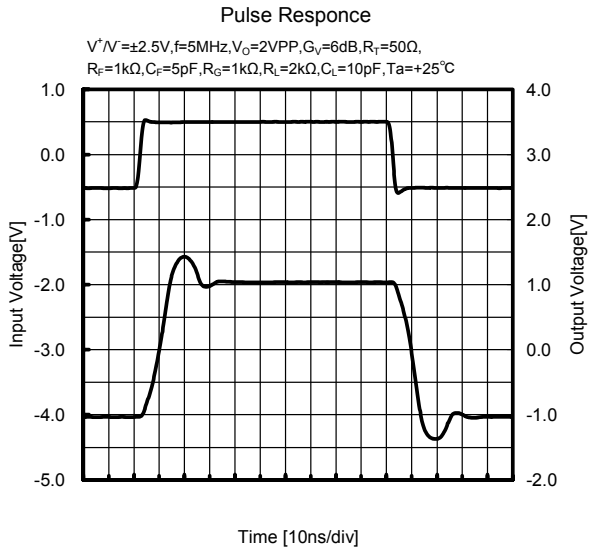

TYPICAL CHARACTERISTICS

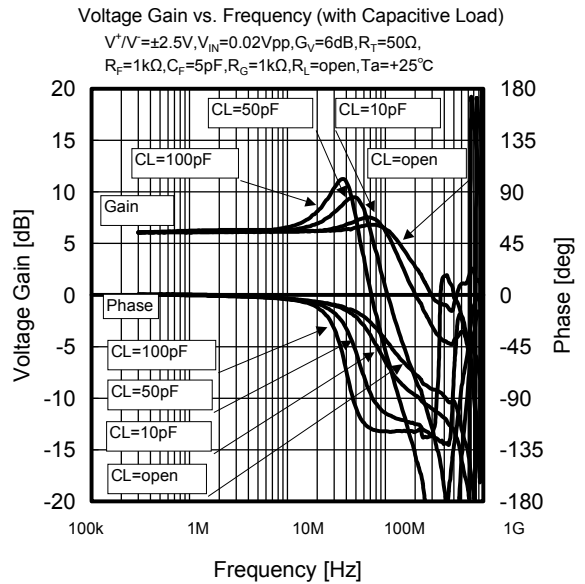
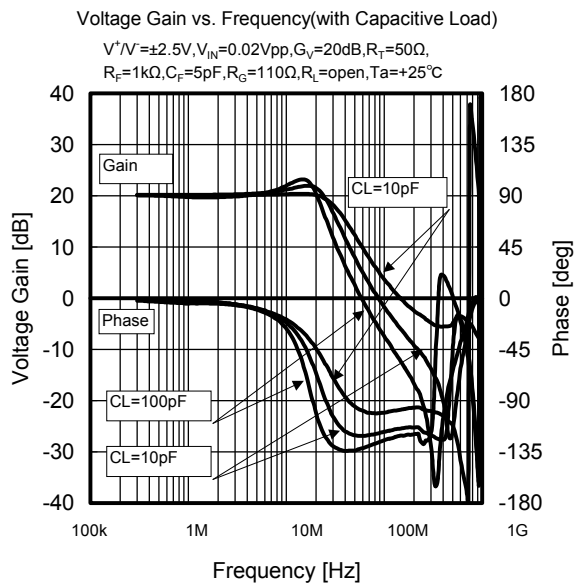
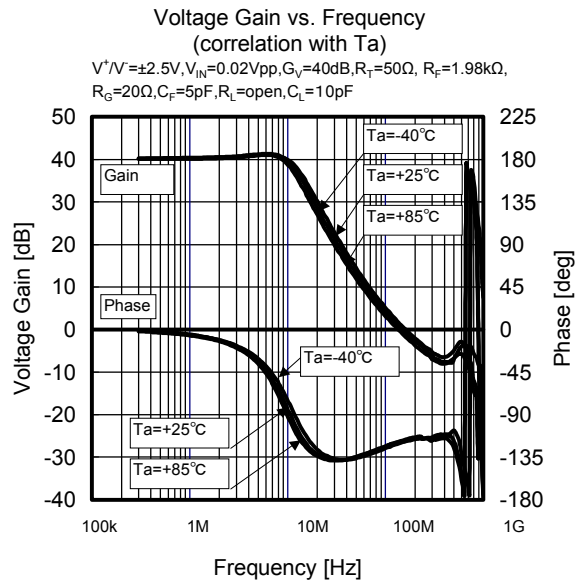
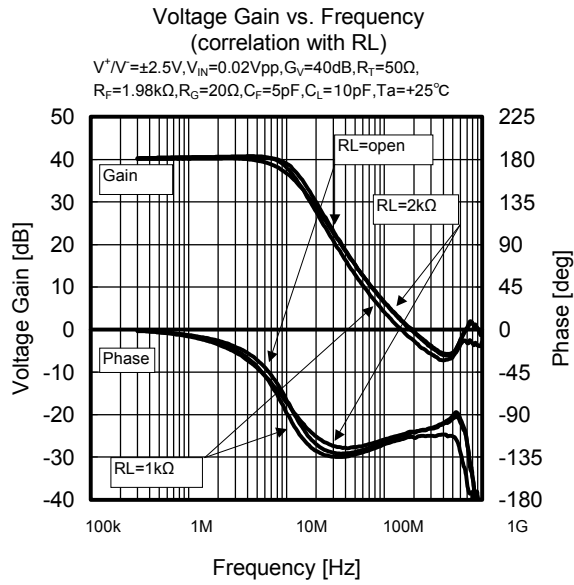

■ MEASUREMENT CIRCUIT

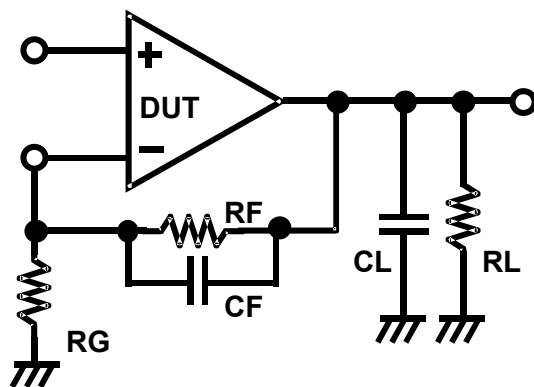

[CAUTION]

The specifications on this databook are only given for information, without any guarantee as regards either mistakes or omissions. The application circuits in this databook are described only to show representative usages of the product and not intended for the guarantee or permission of any right including the industrial rights.

Компания «Life Electronics» занимается поставками электронных компонентов импортного и отечественного производства от производителей и со складов крупных дистрибьюторов Европы, Америки и Азии.

С конца 2013 года компания активно расширяет линейку поставок компонентов по направлению коаксиальный кабель, кварцевые генераторы и конденсаторы (керамические, пленочные, электролитические), за счёт заключения дистрибьюторских договоров

Мы предлагаем:

- Конкурентоспособные цены и скидки постоянным клиентам.
- Специальные условия для постоянных клиентов.
- Подбор аналогов.
- Поставку компонентов в любых объемах, удовлетворяющих вашим потребностям.
- Приемлемые сроки поставки, возможна ускоренная поставка.
- Доставку товара в любую точку России и стран СНГ.
- Комплексную поставку.
- Работу по проектам и поставку образцов.
- Формирование склада под заказчика.
- Сертификаты соответствия на поставляемую продукцию (по желанию клиента).
- Тестирование поставляемой продукции.
- Поставку компонентов, требующих военную и космическую приемку.
- Входной контроль качества.
- Наличие сертификата ISO.

В составе нашей компании организован Конструкторский отдел, призванный помогать разработчикам, и инженерам.

Конструкторский отдел помогает осуществить:

- Регистрацию проекта у производителя компонентов.
- Техническую поддержку проекта.
- Защиту от снятия компонента с производства.
- Оценку стоимости проекта по компонентам.
- Изготовление тестовой платы монтаж и пусконаладочные работы.



Тел: +7 (812) 336 43 04 (многоканальный)

Email: org@lifeelectronics.ru