

## 20A Synchronous Step-Down COT Regulators

### Description

The **XR76121** is a synchronous step-down regulator combining the controller, drivers, bootstrap diode and MOSFETs in a single package for point-of-load supplies. The XR76121 has a load current rating of 20A. A wide 5V to 22V input voltage range allows for single supply operation from industry standard 5V, 12V and 19.6V rails.

With a proprietary emulated current mode constant on-time (COT) control scheme, the XR76121 provides extremely fast line and load transient response using ceramic output capacitors. They require no loop compensation, simplifying circuit implementation and reducing overall component count. The control loop also provides 0.1% load and 0.1% line regulation and maintains constant operating frequency. A selectable power saving mode, allows the user to operate in discontinuous mode (DCM) at light current loads thereby significantly increasing the converter efficiency.

A host of protection features, including overcurrent, over temperature, overvoltage, short-circuit, open feedback detect and UVLO, helps achieve safe operation under abnormal operating conditions.

The XR76121 is available in a RoHS compliant, green/halogen-free space-saving 5mm x 6mm QFN package.

### FEATURES

- 20A step-down regulator
  - 4.5V to 5.5V low  $V_{IN}$  operation
  - 5V to 22V wide single input voltage
  - 3V to 22V operation with external 5V bias
  - $\geq 0.6V$  adjustable output voltage
- Proprietary constant on-time control
  - No loop compensation required
  - Ceramic output capacitor stable operation
  - Programmable 70ns-1 $\mu$ s on-time
  - Constant 200kHz-1MHz frequency
  - Selectable CCM or CCM/DCM operation
- Power-good flag with low impedance when power removed
- Precision enable
- Programmable soft-start
- 5mm x 6mm QFN package

### APPLICATIONS

- Servers
- Distributed power architecture
- Point-of-load converters
- FPGA, DSP and processor supplies
- Base stations, switches/routers

### Typical Application

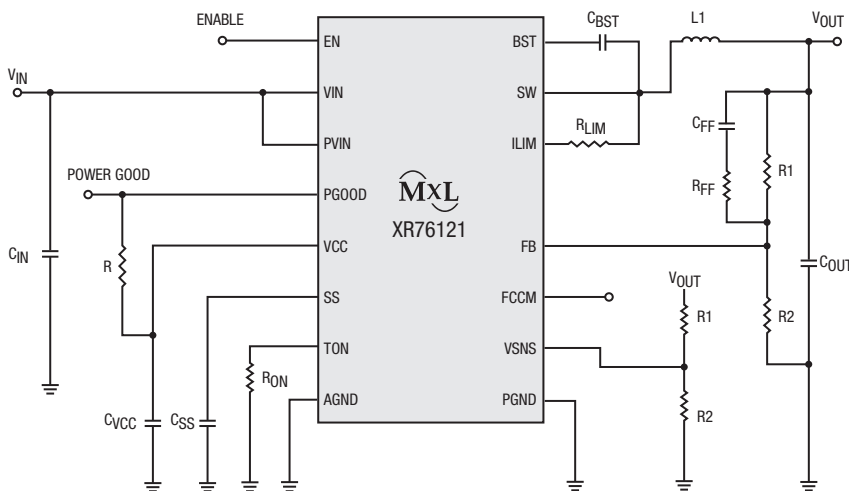

Figure 1. Typical Application

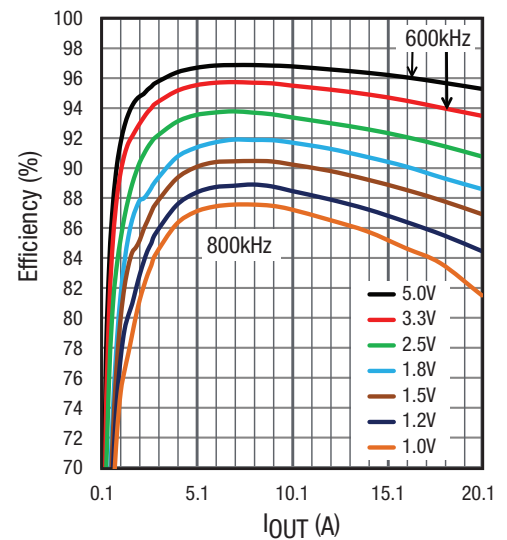

Figure 2. Efficiency

## Absolute Maximum Ratings

These are stress ratings only and functional operation of the device at these ratings or any other above those indicated in the operation sections of the specifications below is not implied. Stresses beyond those listed under absolute maximum ratings may cause permanent damage to the device. Exposure to any absolute maximum rating condition for extended periods may affect device reliability and lifetime.

PV <sub>IN</sub> , V <sub>IN</sub> .....	-0.3V to 25V
V <sub>CC</sub> .....	-0.3V to 6.0V
BST.....	-0.3V to 31V <sup>(1)</sup>
BST-SW.....	-0.3V to 6V
SW, ILIM.....	-1V to 25V <sup>(1)(2)</sup>
All other pins.....	-0.3V to V <sub>CC</sub> + 0.3V
Storage temperature.....	-65°C to 150°C
Junction temperature.....	150°C
Power dissipation.....	Internally limited
Lead temperature (soldering, 10 second).....	300°C
ESD rating (HBM – human body model).....	2kV
ESD rating (CDM – charged device model).....	1kV
ESD rating (MM – machine model).....	200V

## Electrical Characteristics

Specifications are for operating junction temperature of T<sub>J</sub> = 25°C only; limits applying over the full operating junction temperature range are denoted by a •. Typical values represent the most likely parametric norm at T<sub>J</sub> = 25°C, and are provided for reference purposes only. Unless otherwise indicated, V<sub>IN</sub> = 12V, SW = AGND = PGND = 0V, C<sub>VCC</sub> = 4.7µF.

Symbol	Parameter	Conditions	•	Min	Typ	Max	Units
<b>Power Supply Characteristics</b>							
V <sub>IN</sub>	Input voltage range	V <sub>CC</sub> regulating	•	5	12	22	V
		V <sub>CC</sub> tied to V <sub>IN</sub>		4.5	5.0	5.5	
I <sub>VIN</sub>	V <sub>IN</sub> supply current	Not switching, V <sub>IN</sub> = 12V, V <sub>FB</sub> = 0.7V	•		0.8	1.3	mA
I <sub>VCC</sub>	V <sub>CC</sub> quiescent current	Not switching, V <sub>CC</sub> = V <sub>IN</sub> = 5V, V <sub>FB</sub> = 0.7V	•		0.8	1.3	mA
I <sub>VIN</sub>	V <sub>IN</sub> supply current	f = 600kHz, R <sub>ON</sub> = 49.9k, V <sub>FB</sub> = 0.58V			17		mA
I <sub>OFF</sub>	Shutdown current	Enable = 0V, PV <sub>IN</sub> = V <sub>IN</sub> = 12V			1		µA
<b>Enable and Undervoltage Lock-Out UVLO</b>							
V <sub>IH_EN</sub>	EN pin rising threshold		•	1.8	1.9	2.0	V
V <sub>EN_HYS</sub>	EN pin hysteresis				60		mV
	V <sub>CC</sub> UVLO start threshold, rising edge		•	4.00	4.25	4.40	V
	V <sub>CC</sub> UVLO hysteresis		•	100	170		mV

## Operating Conditions

PV <sub>IN</sub> .....	3V to 22V
V <sub>IN</sub> .....	4.5V to 22V
V <sub>CC</sub> .....	4.5V to 5.5V
SW, ILIM.....	-1V to 22V <sup>(2)</sup>
PGOOD, TON, SS, EN.....	-0.3V to 5.5V <sup>(2)</sup>
Switching frequency.....	200kHz-1MHz <sup>(3)</sup>
Junction temperature range (T <sub>J</sub> ).....	-40°C to 125°C
Package power dissipation max at 25°C.....	4.1W
Package thermal resistance θ <sub>JA</sub> .....	24°C/W <sup>(4)</sup>

### NOTES:

1. No external voltage applied.
2. SW pin's DC range is -1V, transient is -5V for less than 50ns.
3. Recommended.
4. Measured on MaxLinear evaluation board.

## Electrical Characteristics (Continued)

Specifications are for operating junction temperature of  $T_J = 25^\circ\text{C}$  only; limits applying over the full operating junction temperature range are denoted by a •. Typical values represent the most likely parametric norm at  $T_J = 25^\circ\text{C}$ , and are provided for reference purposes only. Unless otherwise indicated,  $V_{IN} = 12\text{V}$ ,  $SW = AGND = PGND = 0\text{V}$ ,  $C_{VCC} = 4.7\mu\text{F}$ .

Symbol	Parameter	Conditions	•	Min	Typ	Max	Units
Reference Voltage							
$V_{REF}$	Reference voltage	$V_{IN} = 5\text{V} - 22\text{V}$ , $V_{CC}$ regulating		0.597	0.600	0.603	V
		$V_{IN} = 4.5\text{V} - 5.5\text{V}$ , $V_{CC}$ tied to $V_{IN}$		0.596	0.600	0.604	V
		$V_{IN} = 5\text{V} - 22\text{V}$ , $V_{CC}$ regulating $V_{IN} = 4.5\text{V} - 5.5\text{V}$ , $V_{CC}$ tied to $V_{IN}$	•	0.594	0.600	0.606	V
	DC load regulation	CCM operation, closed loop, applies to any $C_{OUT}$			$\pm 0.1$		%
	DC line regulation				$\pm 0.1$		%
Programmable Constant On-Time							
	On-time 1	$R_{ON} = 5.90\text{k}\Omega$ , $V_{IN} = 12\text{V}$	•	170	200	230	ns
	f corresponding to on-time 1	$V_{OUT} = 1.0\text{V}$		360	415	490	kHz
	On-time 2	$R_{ON} = 16.2\text{k}\Omega$ , $V_{IN} = 12\text{V}$	•	425	500	575	ns
	f corresponding to on-time 2	$V_{OUT} = 3.3\text{V}$		478	550	647	kHz
	On-time 3	$R_{ON} = 3.01\text{k}\Omega$ , $V_{IN} = 12\text{V}$	•	90	110	135	ns
	Minimum off-time		•		250	350	ns
Diode Emulation Mode							
	Zero crossing threshold	DC value measured during test			-2		mV
Soft-Start							
$I_{SS\_CHARGE}$	Charge current		•	-14	-10	-6	$\mu\text{A}$
$I_{SS\_DISCHARGE}$	Discharge current	Fault present	•	1	3		mA
$V_{CC}$ Linear Regulator							
$V_{CC}$	Output voltage	$V_{IN} = 6\text{V}$ to $22\text{V}$ , $I_{LOAD} = 0$ to $30\text{mA}$	•	4.8	5.0	5.2	V
		$V_{IN} = 5\text{V}$ , $R_{ON} = 16.2\text{k}\Omega$ , $f_{SW} = 678\text{kHz}$	•	4.6	4.8		
Power Good Output							
	Power good threshold			-10	-7.5	-5	%
	Power good hysteresis				1	4	%
	Power good	Minimum $I_{SINK} = 1\text{mA}$				0.2	V
	Power good, unpowered	$I_{SINK} = 1\text{mA}$				0.5	V
	Power good assertion delay, FB rising				2		ms
	Power good de-assertion delay, FB falling				65		$\mu\text{s}$

## Electrical Characteristics (Continued)

Specifications are for operating junction temperature of  $T_J = 25^\circ\text{C}$  only; limits applying over the full operating junction temperature range are denoted by a •. Typical values represent the most likely parametric norm at  $T_J = 25^\circ\text{C}$ , and are provided for reference purposes only. Unless otherwise indicated,  $V_{IN} = 12\text{V}$ ,  $SW = AGND = PGND = 0\text{V}$ ,  $C_{VCC} = 4.7\mu\text{F}$ .

Symbol	Parameter	Conditions	•	Min	Typ	Max	Units
Mode Control (FCCM)							
	FCCM mode logic high threshold	FCCM rising	•	2.4			V
	FCCM mode logic low threshold	FCCM falling	•			0.4	V
	Input leakage current				100		nA
Open Feedback/OVP Detect (VSNS)							
	OVP trip high threshold	VSNS rising. Specified as % of $V_{REF}$	•	115	120	125	%
	OVP trip low threshold	VSNS falling. Specified as % of $V_{REF}$	•		115		%
	OVP comparator delay	VSNS rising	•	0.5	1	3.5	$\mu\text{s}$
	Delay to turn off power stage from an overvoltage event	VSNS rising	•			3.5	$\mu\text{s}$
Protection: OCP, OTP, Short-Circuit							
	Hiccup timeout				110		ms
	$I_{LIM}/R_{DS}$			14.5	16.2	18.0	$\mu\text{A}/\text{m}\Omega$
	$I_{LIM}$ current temperature coefficient				0.4		$\%/^\circ\text{C}$
	$I_{LIM}$ comparator offset			-4.7	0	4.7	mV
	$I_{LIM}$ comparator offset		•	-8.0	0	8.0	mV
	Current limit blanking				100		ns
	Thermal shutdown threshold	Rising temperature			138		$^\circ\text{C}$
	Thermal hysteresis				15		$^\circ\text{C}$
	Feedback pin short-circuit threshold	Percent of $V_{REF}$ , short circuit is active. After PGOOD asserts high.	•	50	60	70	%
Output Power Stage							
	High-side MOSFET $R_{DS(ON)}$	$I_{DS} = 2\text{A}$			7.7	10	$\text{m}\Omega$
	Low-side MOSFET $R_{DS(ON)}$	$I_{DS} = 2\text{A}$			3.1	3.5	$\text{m}\Omega$
	Maximum output current		•	20			A

## Pin Configuration

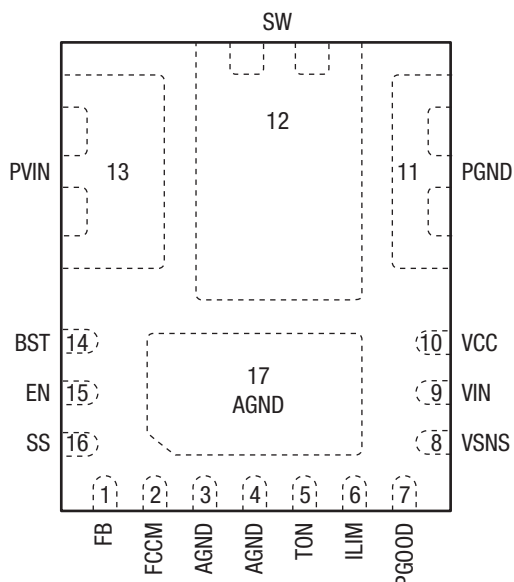

## Pin Functions

Pin Number	Pin Name	Type	Description
1	FB	A	Feedback input to feedback comparator.
2	FCCM	I	Forcing this pin logic level high forces CCM operation.
3	AGND	A	Signal ground for control circuitry. Connect to AGND pad with a short trace.
4			
5	TON	A	Constant on-time programming pin. Connect with a resistor to AGND.
6	ILIM	A	Overcurrent protection programming. Connect with a resistor to SW.
7	PGOOD	OD	Power-good output. Open drain to AGND. Low Z when IC unpowered.
8	VSNS	A	Sense pin for output OVP and open FB.
9	VIN	A	Supply input for the regulator's LDO. Normally connected to PV <sub>IN</sub> .
10	VCC	A	The output of regulators LDO. It requires a 4.7μF V <sub>CC</sub> bypass capacitor. For operation using a 5V rail, VCC should be tied to VIN.
11	PGND	PWR	Ground of the power stage. Internally connected to source of the low-side MOSFET.
12	SW	PWR	Switch node. Internally it connects source of the high-side MOSFET to drain of the low-side MOSFET.
13	PVIN	PWR	Input voltage for power stage. Internally connected to drain of the high-side MOSFET.
14	BST	A	High-side driver supply pin. Connect a 0.1μF bootstrap capacitor between BST and SW.
15	EN	I	Precision enable pin. Pulling this pin above 2V will enable the regulator.
16	SS	A	Soft-start pin. Connect an external capacitor between SS and AGND to program the soft-start rate based on the 10μA internal source current.
17	AGND PAD	A	Signal ground for control circuitry.

**NOTE:**

A = Analog, I = Input, O = Output, OD = Open Drain, PWR = Power.

## Typical Performance Characteristics

### Efficiency and Package Thermal Derating

Unless otherwise specified:  $T_{AMBIENT} = 25^{\circ}C$ , no airflow,  $f = 800kHz$ . Efficiency data includes inductor losses, schematic from the Application Information section of this datasheet.

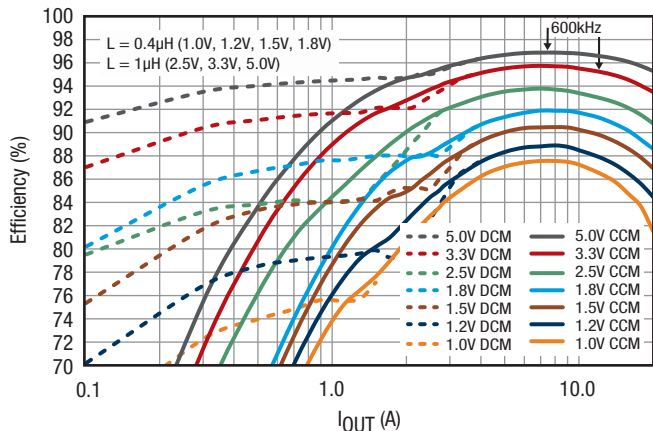

Figure 3. Efficiency,  $V_{IN} = 12V$

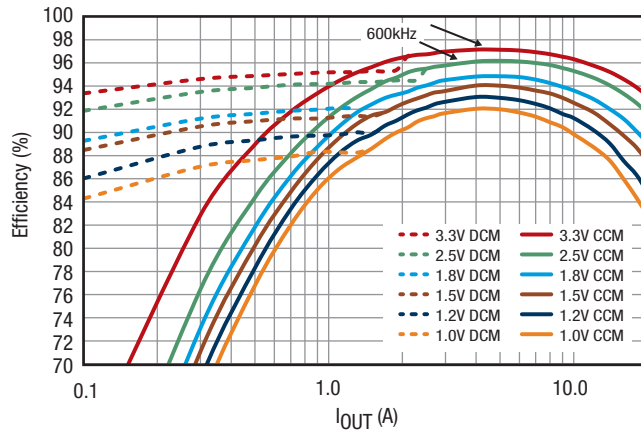

Figure 4. Efficiency,  $V_{IN} = 5V$ ,  $L = 0.4\mu H$

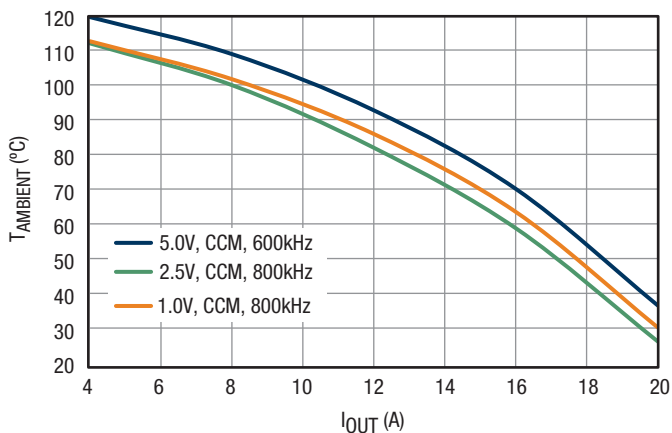

Figure 5. Maximum  $T_{AMBIENT}$  vs.  $I_{OUT}$ ,  $V_{IN} = 12V$ , No Airflow

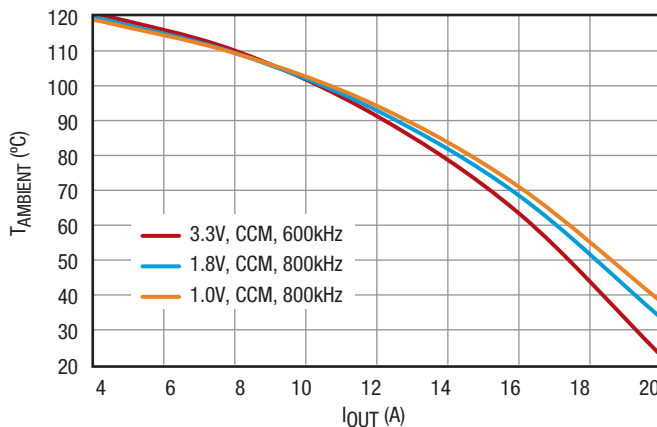

Figure 6. Maximum  $T_{AMBIENT}$  vs.  $I_{OUT}$ ,  $V_{IN} = 5V$ , No Airflow

Typical Performance Characteristics (Continued)

All data taken at  $V_{IN} = 12V$ ,  $V_{OUT} = 1.8V$ ,  $f = 800kHz$ ,  $T_A = 25^\circ C$ , no airflow, forced CCM. (Unless otherwise specified). Schematic from the Applications Information section of this datasheet.

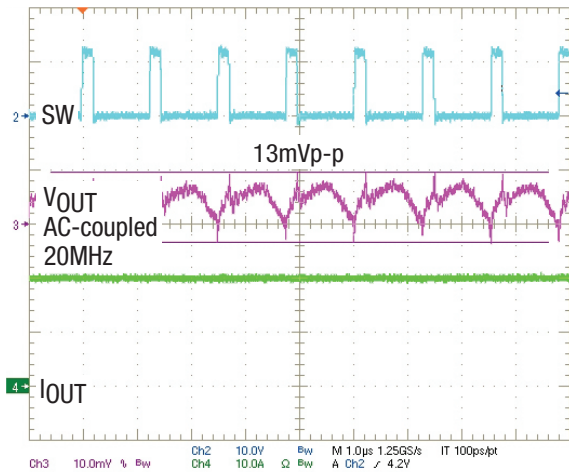

Figure 7. Steady State,  $I_{OUT} = 20A$

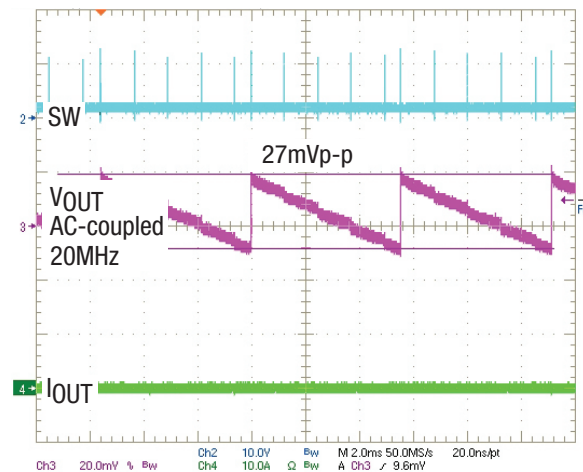

Figure 8. Steady State, DCM,  $I_{OUT} = 0A$

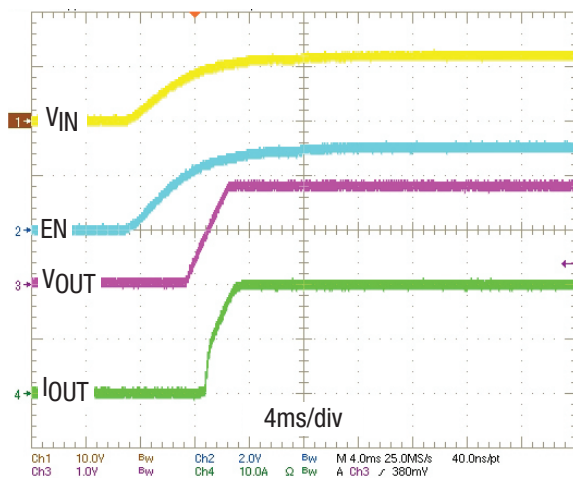

Figure 9. Power-Up,  $I_{OUT} = 20A$

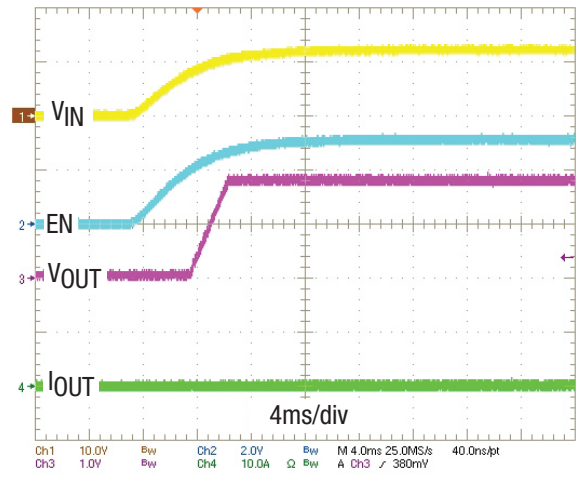

Figure 10. Power-Up,  $I_{OUT} = 0A$

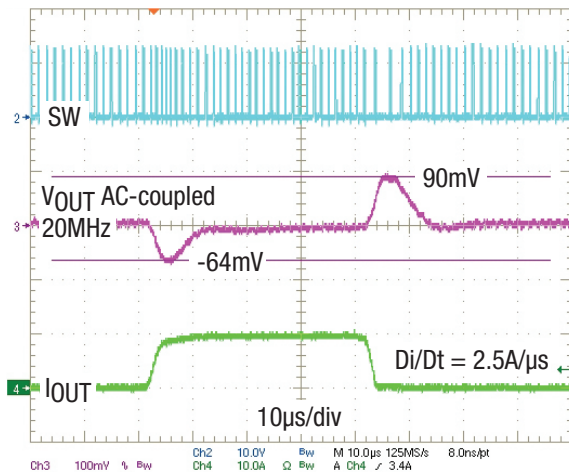

Figure 11. Load Transient, Forced CCM, 0A-10A-0A

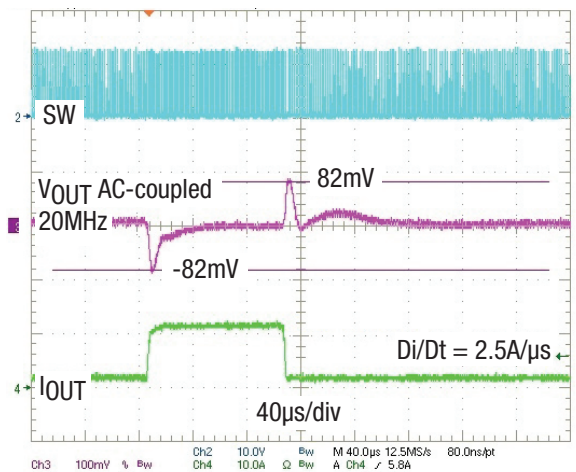

Figure 12. Load Transient, DCM, 1.8A-11.8A-1.8A



**Typical Performance Characteristics (Continued)**

All data taken at  $V_{IN} = 12V$ ,  $V_{OUT} = 1.8V$ ,  $f = 800kHz$ ,  $T_A = 25^{\circ}C$ , no airflow, forced CCM. (Unless otherwise specified). Schematic from the Applications Information section of this datasheet.

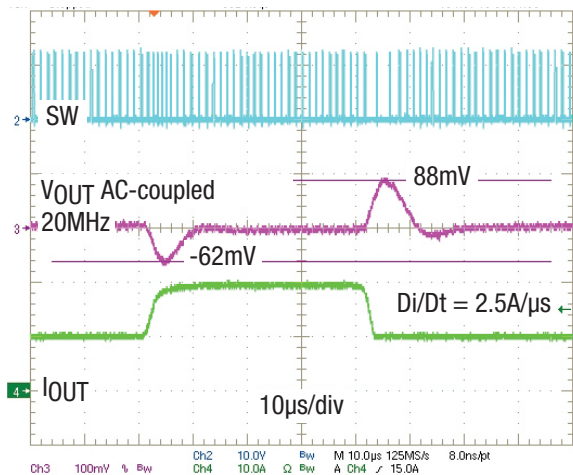

Figure 13. Load Transient, DCM or Forced CCM, 10A-20A-10A

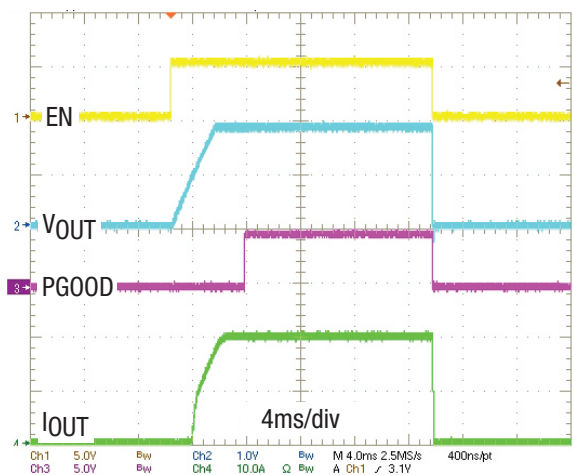

Figure 14. Enable Functionality,  $V_{IN} = 12V$

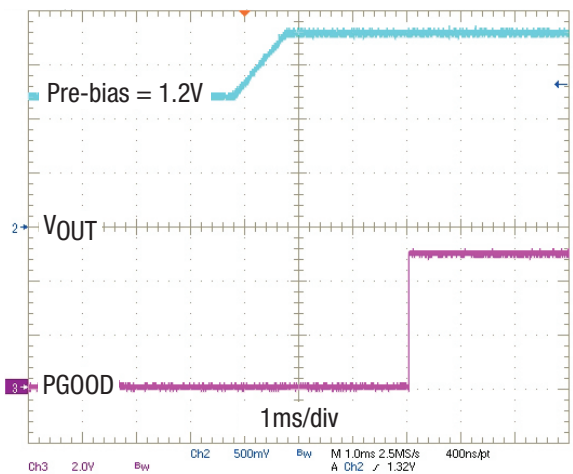

Figure 15. Power-Up with Pre-Bias Voltage,  $I_{OUT} = 0A$

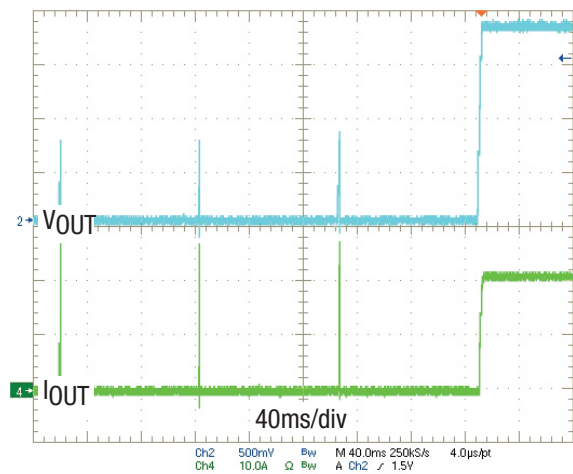

Figure 16. Short-Circuit Recovery,  $I_{OUT} = 20A$



**Typical Performance Characteristics (Continued)**

All data taken at  $V_{IN} = 12V$ ,  $V_{OUT} = 1.8V$ ,  $f = 800kHz$ ,  $T_A = 25^\circ C$ , no airflow, forced CCM. (Unless otherwise specified). Schematic from the Applications Information section of this datasheet.

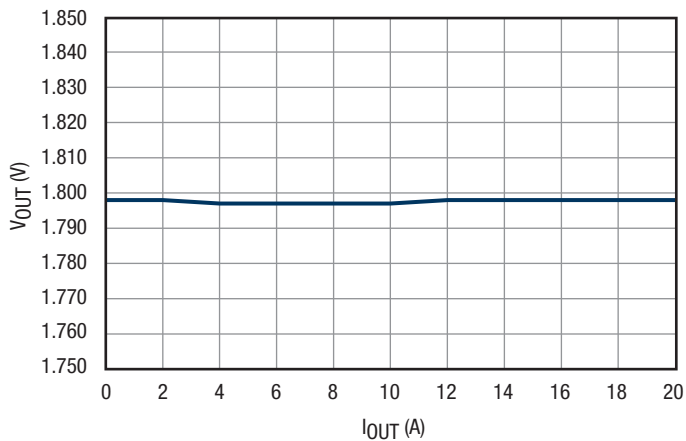

Figure 17. Load Regulation

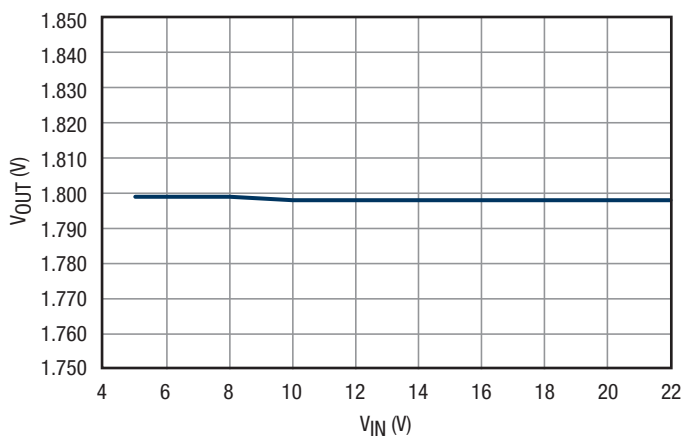

Figure 18. Line Regulation

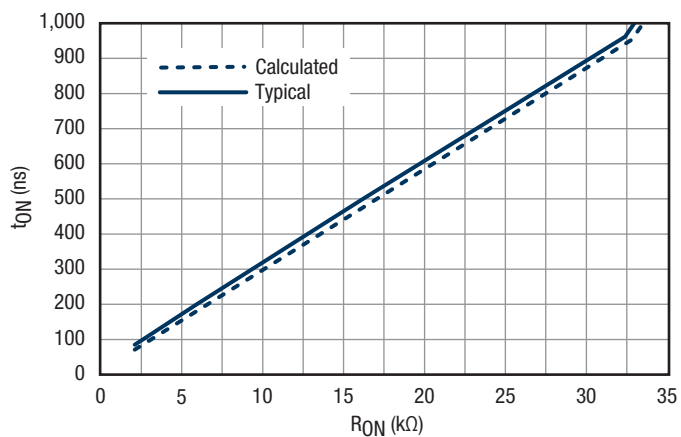

Figure 19.  $t_{ON}$  vs.  $R_{ON}$

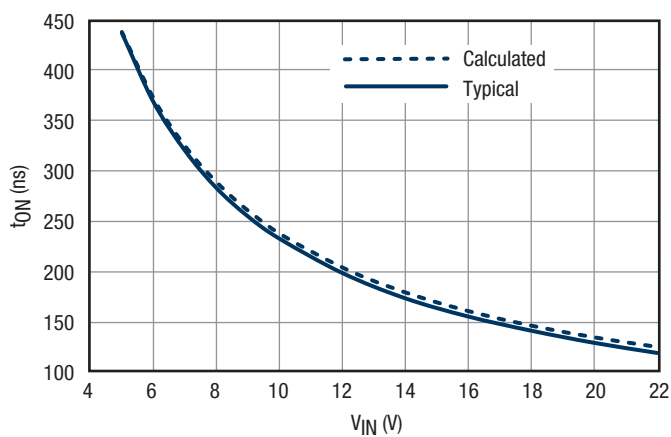

Figure 20.  $t_{ON}$  vs.  $V_{IN}$ ,  $R_{ON} = 5.9k\Omega$

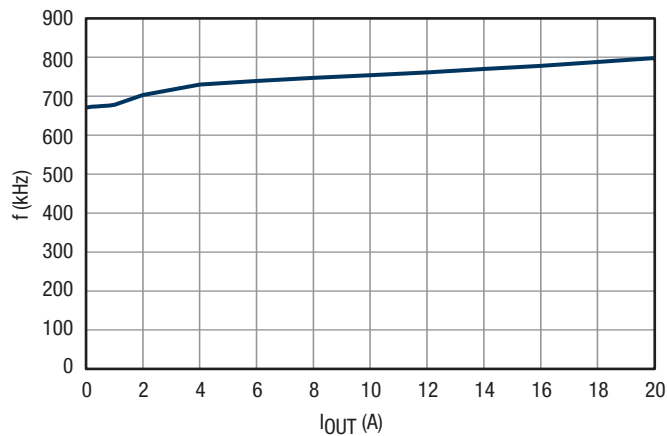

Figure 21. Frequency vs.  $I_{OUT}$

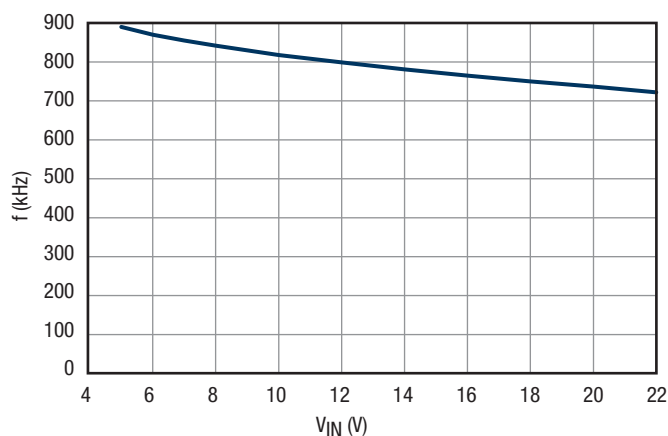

Figure 22. Frequency vs.  $V_{IN}$

### Typical Performance Characteristics (Continued)

All data taken at  $V_{IN} = 12V$ ,  $V_{OUT} = 1.8V$ ,  $f = 800kHz$ ,  $T_A = 25^\circ C$ , no airflow, forced CCM. (Unless otherwise specified). Schematic from the Applications Information section of this datasheet.

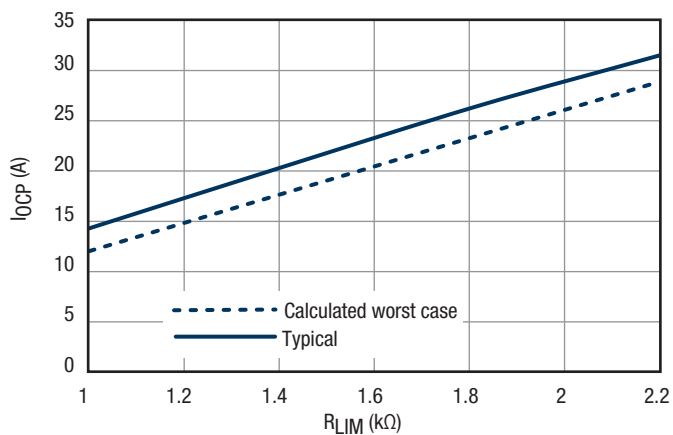

Figure 23.  $I_{OCP}$  vs.  $R_{LIM}$

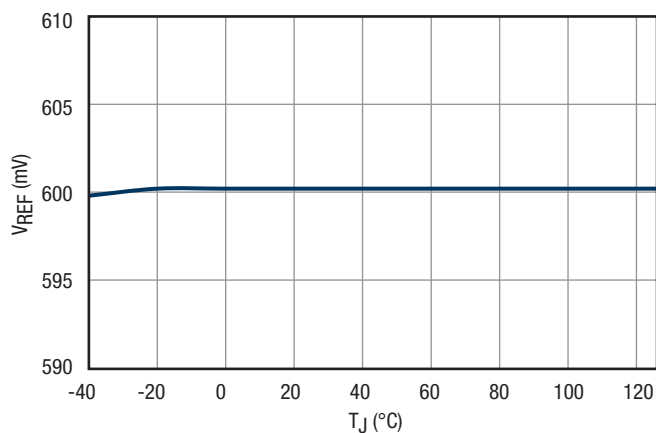

Figure 24.  $V_{REF}$  vs. Temperature

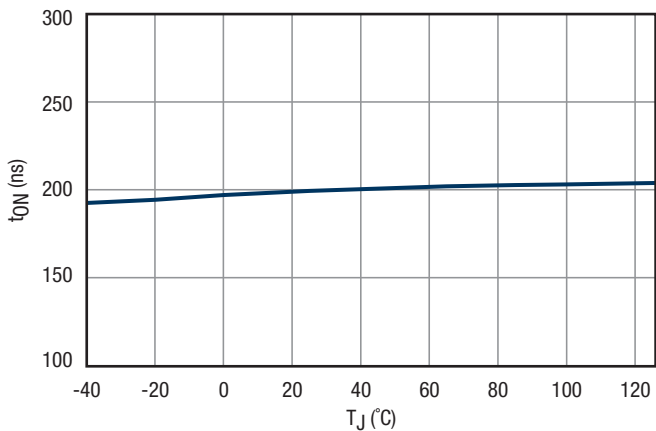

Figure 25.  $t_{ON}$  vs. Temperature,  $R_{ON} = 5.9k$

Functional Block Diagram

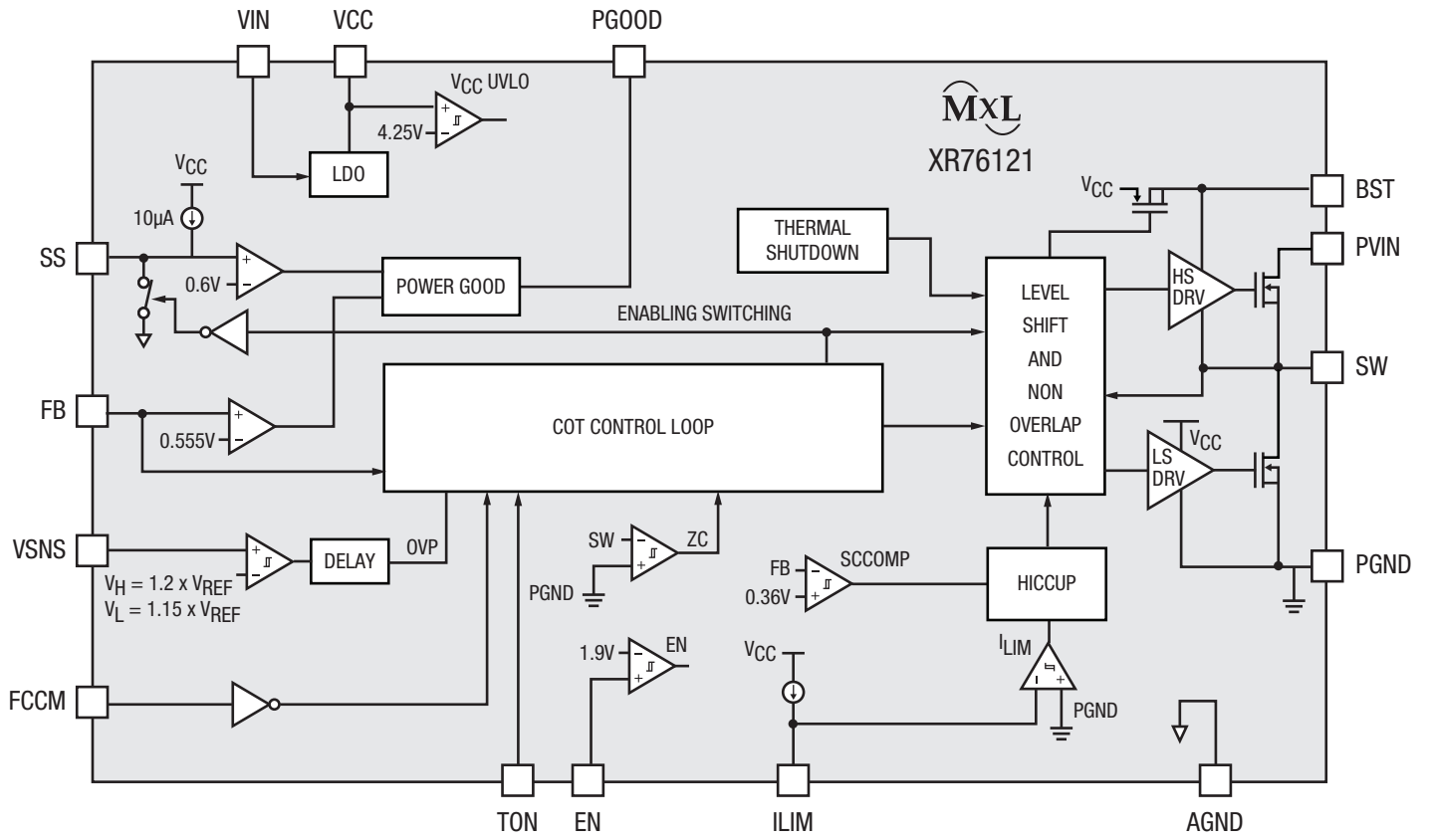

Figure 26. Functional Block Diagram

## Applications Information

### Detailed Operation

The XR76121 uses a synchronous step-down proprietary emulated current-mode Constant On-Time (COT) control scheme. The on-time, which is programmed via  $R_{ON}$ , is inversely proportional to  $V_{IN}$  and maintains a nearly constant frequency. The emulated current-mode control allows the use of ceramic output capacitors.

Each switching cycle begins with the high-side (switching) FET turning on for a preprogrammed time. At the end of the on-time, the high-side FET is turned off and the low-side (synchronous) FET is turned on for a preset minimum time (250ns nominal). This parameter is termed the minimum off-time. After the minimum off-time the voltage at the feedback pin FB is compared to an internal voltage ramp at the feedback comparator. When  $V_{FB}$  drops below the ramp voltage, the high-side FET is turned on and the cycle repeats. This voltage ramp constitutes an emulated current ramp and allows for the use of ceramic capacitors, in addition to other capacitor types, for output filtering.

### Enable

The enable input provides precise control for startup. Where bus voltage is well regulated, the enable input can be derived from this voltage with a suitable resistor divider. This ensures that XR76121 does not turn on until bus voltage reaches the desired level. Therefore the enable feature allows implementation of undervoltage lockout for the bus voltage  $PV_{IN}$ . Simple sequencing can be implemented by using the PGOOD signal as the enable input of a succeeding XR76121. Sequencing can also be achieved by using an external signal to control the enable pin.

### Selecting the Forced CCM Mode

A voltage higher than 2.4V at the FCCM pin forces the XR76121 to operate in continuous conduction mode (CCM). Note that discontinuous conduction mode (DCM) is always on during soft-start. DCM will persist following soft-start until a sufficient load is applied to transition the regulator to CCM. Magnitude of the load required to transition to CCM is  $\Delta I_L/2$ , where  $\Delta I_L$  is peak-to-peak inductor current ripple. Once the regulator transitions to CCM it will continue operating in CCM regardless of the load magnitude.

### Selecting the DCM/CCM Mode

The DCM will always be available if a voltage less than 0.4V is applied to the FCCM pin. XR76121 will operate in either DCM or CCM depending on the load magnitude. At light loads DCM significantly increases efficiency as seen in Figures 3 and 4. A preload of 10mA is recommended for DCM operation. This helps improve voltage regulation when external load is less than 10mA and may reduce voltage ripple.

### Programming the On-Time

The on-time  $t_{ON}$  is programmed via resistor  $R_{ON}$  according to following equation:

$$R_{ON} = \frac{V_{IN} \times [t_{ON} - (2.5 \times 10^{-8})]}{3.45 \times 10^{-10}}$$

A graph of  $t_{ON}$  versus  $R_{ON}$ , using the above equation, is compared to typical test data in Figure 19. The graph shows that calculated data matches typical test data within 3%.

The  $t_{ON}$  corresponding to a particular set of operating conditions can be calculated based on empirical data from:

$$t_{ON} = \frac{V_{OUT}}{V_{IN} \times 1.06 \times f \times \text{Eff.}}$$

Where:

- $f$  is the desired switching frequency at nominal  $I_{OUT}$ .
- Eff. is the converter efficiency corresponding to nominal  $I_{OUT}$ .

Substituting for  $t_{ON}$  in the first equation we get:

$$R_{ON} = \frac{\left( \frac{V_{OUT}}{1.06 \times f \times \text{Eff.}} \right) - [(2.5 \times 10^{-8}) \times V_{IN}]}{(3.45 \times 10^{-10})}$$

Now  $R_{ON}$  can be calculated in terms of operating conditions  $V_{IN}$ ,  $V_{OUT}$ ,  $f$  and efficiency using the above equation.

At  $V_{IN} = 12V$ ,  $f = 800\text{kHz}$ ,  $I_{OUT} = 20A$  and using the efficiency numbers from Figure 3 we get the following  $R_{ON}$ :

$V_{OUT}$ (V)	Eff. (%)	$f$ (kHz)	$R_{ON}$ (k $\Omega$ )
5.0	0.95	600	23.12
3.3	0.93	600	15.30
2.5	0.91	800	8.52
1.8	0.89	800	6.04
1.5	0.87	800	5.02
1.2	0.84	800	4.01
1.0	0.81	800	3.35

XR76121  $R_{ON}$  for common output voltages,  
 $V_{IN} = 12V$ ,  $I_{OUT} = 20A$

## Applications Information (Continued)

### Overcurrent Protection (OCP)

If the load current exceeds the programmed overcurrent threshold  $I_{OCP}$  for four consecutive switching cycles, the regulator enters the hiccup mode of operation. In hiccup mode the MOSFET gates are turned off for 110ms (hiccup timeout). Following the hiccup timeout a soft-start is attempted. If OCP persists, hiccup timeout will repeat. The regulator will remain in hiccup mode until load current is reduced below the programmed  $I_{OCP}$ . In order to program overcurrent protection use the following equation:

$$R_{LIM} = \left[ \frac{(I_{OCP} + (0.5 \times \Delta I_L))}{\left( \frac{I_{LIM}}{R_{DS}} \right)} \right] + 0.16k\Omega$$

Where:

- $R_{LIM}$  is resistor value in  $k\Omega$  for programming  $I_{OCP}$
- $I_{OCP}$  is the overcurrent value to be programmed
- $\Delta I_L$  is the peak-to-peak inductor current ripple
- $I_{LIM}/R_{DS}$  is the minimum value of the parameter specified in the tabulated data
- $I_{LIM}/R_{DS} = 14.5\mu A/m\Omega$
- $0.16k\Omega$  accounts for OCP comparator offset

The above equation is for worst-case analysis and safeguards against premature OCP. Typical value of  $I_{OCP}$ , for a given  $R_{LIM}$ , will be higher than that predicted by the above equation. Graph of calculated  $I_{OCP}$  vs.  $R_{LIM}$  is compared to typical  $I_{OCP}$  in Figures 23.

### Short-Circuit Protection (SCP)

If the output voltage drops below 60% of its programmed value (i.e., FB drops below 0.36V), the regulator will enter hiccup mode. Hiccup mode will persist until short-circuit is removed. The SCP circuit becomes active at the end of soft-start. Hiccup mode and short-circuit recovery waveform is shown in Figure 16.

### Over Temperature Protection (OTP)

OTP triggers at a nominal controller temperature of 138°C. The gates of the switching FET and the synchronous FET are turned off. When controller temperature cools down to 123°C, soft-start is initiated and regular operation resumes.

### Overvoltage Protection (OVP)

The output OVP function detects an overvoltage condition on  $V_{OUT}$  of the regulator. OVP is achieved by comparing the voltage at VSNS pin to an OVP threshold voltage set at  $1.2 \times V_{REF}$ . When VSNS voltage exceeds the OVP threshold, an internal overvoltage signal asserts after 1us (typical). This OVP signal latches off the high-side FET, turns on the low-side FET and also asserts PGOOD low. The low-side FET remains on to discharge the output capacitor until VSNS voltage drops below  $1.15 \times V_{REF}$ . Then low-side FET turns off to prevent complete discharge of  $V_{OUT}$ . The high-side and low-side FETs remain latched off until  $V_{IN}$  or EN is recycled. In order to use this feature, connect VSNS to  $V_{OUT}$  with a resistor divider as shown in the application circuit. Use the same resistor divider value that was used for programming  $V_{OUT}$ .

### Programming the Output Voltage

Use a voltage divider as shown in Figure 1 to program the output voltage  $V_{OUT}$ .

$$R1 = R2 \times \left( \frac{V_{OUT}}{0.6} - 1 \right)$$

The recommended value for R2 is 2k $\Omega$ .

### Programming the Soft-Start

Place a capacitor  $C_{SS}$  between the SS and AGND pins to program the soft-start. In order to program a soft-start time of  $t_{SS}$ , calculate the required capacitance  $C_{SS}$  from the following equation:

$$C_{SS} = t_{SS} \times \frac{10\mu A}{0.6V}$$

### Pre-Bias Startup

XR76121 has the capability to startup into a pre-charged output. Typical pre-bias startup waveforms are shown in Figure 15.

### Maximum Allowable Voltage Ripple at FB Pin

The steady-state voltage ripple at feedback pin FB ( $V_{FB,RIPPLE}$ ) must not exceed 50mV in order for the regulator to function correctly. If  $V_{FB,RIPPLE}$  is larger than 50mV then  $C_{OUT}$  and/or L should be increased as necessary in order to keep the  $V_{FB,RIPPLE}$  below 50mV.

## Applications Information (Continued)

### Feed-Forward Capacitor ( $C_{FF}$ )

The feed-forward capacitor  $C_{FF}$  is used to set the necessary phase margin when using ceramic output capacitors. Calculate  $C_{FF}$  from the following equation:

$$C_{FF} = \frac{1}{2 \times \pi \times R1 \times 5 \times f_{LC}}$$

Where  $f_{LC}$ , the output filter double-pole frequency is calculated from:

$$f_{LC} = \frac{1}{2 \times \pi \times \sqrt{L \times C_{OUT}}}$$

You must use manufacturer's DC derating curves to determine the effective capacitance corresponding to  $V_{OUT}$ . A load step test (and/or a loop frequency response test) should be performed and if necessary  $C_{FF}$  can be adjusted in order to get a critically damped transient load response.

In applications where output voltage ripple is less than about 3mV, such as when a large number of ceramic  $C_{OUT}$  are paralleled, it is necessary to use ripple injection from across the inductor. The circuit and corresponding calculations are explained in the MaxLinear design note.

### Feed-Forward Resistor ( $R_{FF}$ )

$R_{FF}$  is required when  $C_{FF}$  is used.  $R_{FF}$ , in conjunction with  $C_{FF}$ , functions similar to a high frequency pole and adds gain margin to the frequency response. Calculate  $R_{FF}$  from:

$$R_{FF} = \frac{1}{2 \times \pi \times f \times C_{FF}}$$

Where  $f$  is the switching frequency.

If  $R_{FF}$  is greater than  $0.1 \times R1$ , then instead of  $C_{FF}/R_{FF}$ , use ripple injection circuit as described in MaxLinear's design note.

### Thermal Design

Proper thermal design is critical in controlling device temperatures and in achieving robust designs. There are a number of factors that affect the thermal performance. One key factor is the temperature rise of the devices in the package, which is a function of the thermal resistances of the devices inside the package and the power being dissipated.

The thermal resistance of the XR76121 is specified in the Operating Ratings section of this datasheet. The  $\theta_{JA}$  thermal resistance specification is based on the XR76121 evaluation board operating without forced airflow. Since the actual board design in the final application will be different, the thermal resistances in the final design may be different from those specified.

The package thermal derating curves for the XR76121 are shown in Figures 5 and 6. These correspond to input voltage of 12V and 5V, respectively. The package thermal derating curves for the XR76121 are shown in Figures 9 and 10.

Applications Information

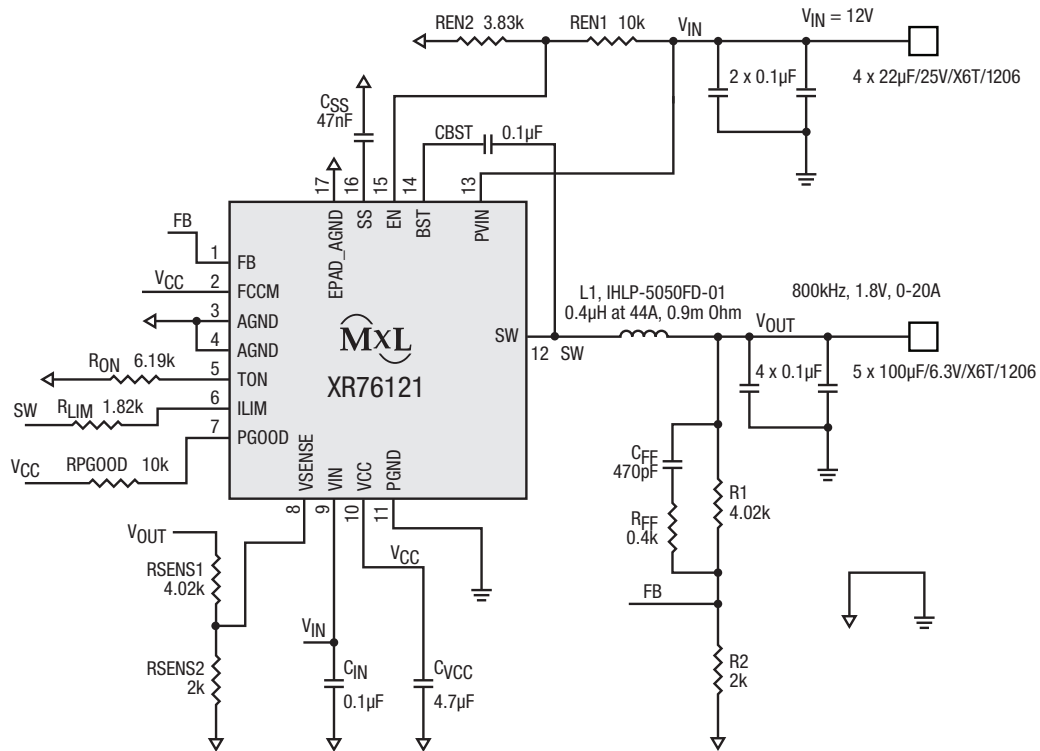
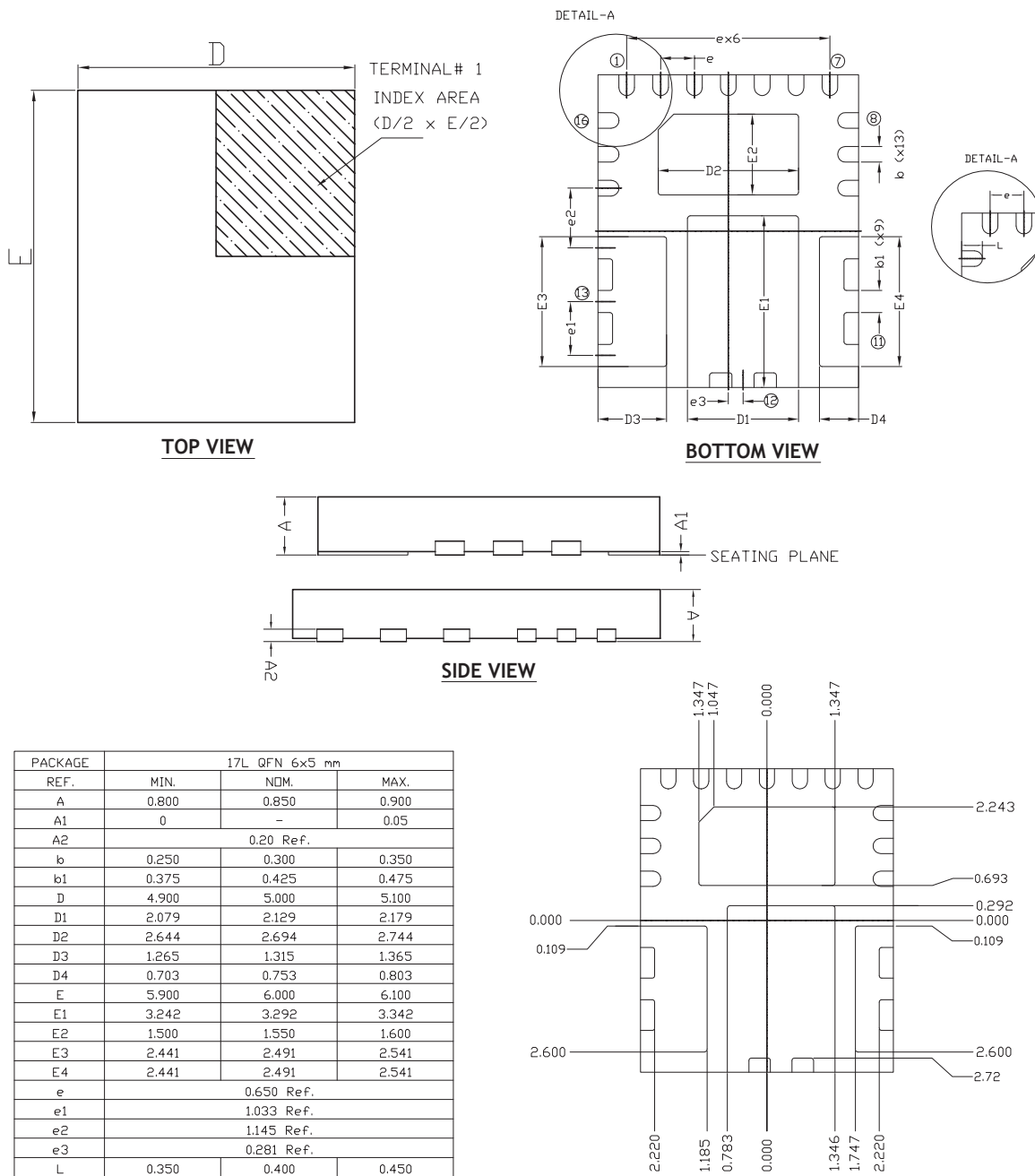

Figure 27. Application Circuit Schematic



Mechanical Dimensions



NOTE : ALL DIMENSIONS ARE IN MILLIMETERS, ANGLES ARE IN DEGREES.

Drawing No.: POD-00000071

Revision: C

Figure 28. Mechanical Dimensions

Recommended Land Pattern and Stencil

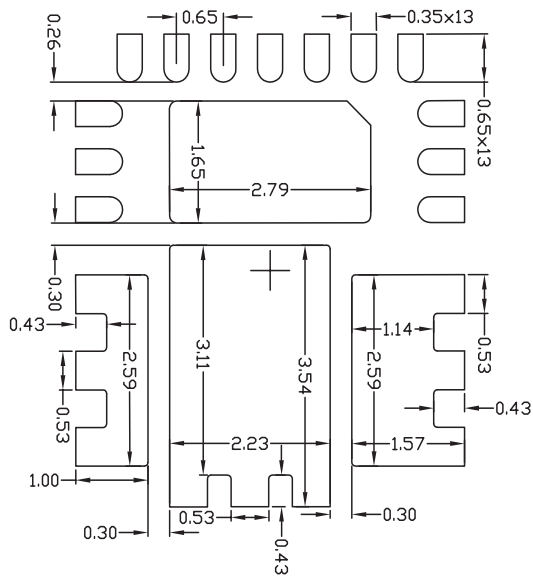

TYPICAL RECOMMENDED LAND PATTERN

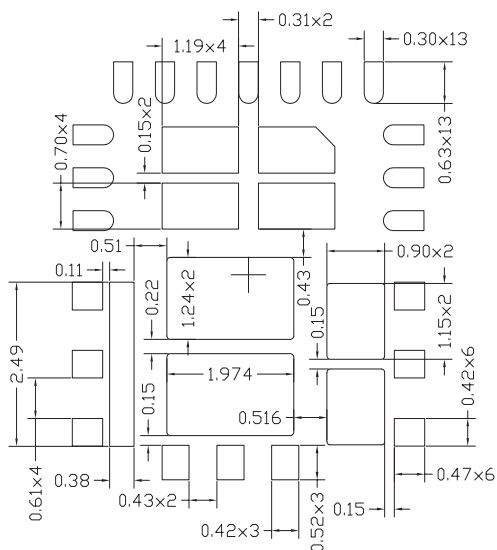

TYPICAL RECOMMENDED STENCIL

NOTE : ALL DIMENSIONS ARE IN MILLIMETERS, ANGLES ARE IN DEGREES.

Drawing No.: POD-00000071

Revision: C

Figure 29. Recommended Land Pattern and Stencil

Ordering Information<sup>(1)</sup>

Part Number	Operating Temperature Range	Lead-Free	Package	Packaging Method
XR76121EL-F	-40°C ≤ T <sub>J</sub> ≤ 125°C	Yes <sup>(2)</sup>	5mm x 6mm QFN	Bulk
XR76121ELMTR-F				Tape and Reel
XR76121ELTR-F				Tape and Reel
XR76121EVB	XR76121 evaluation board			

**NOTE:**

1. Refer to [www.exar.com/XR76121](http://www.exar.com/XR76121) for most up-to-date Ordering Information.
2. Visit [www.exar.com](http://www.exar.com) for additional information on Environmental Rating.

## Revision History

Revision	Date	Description
1A	July 2016	Initial Release
1B	November 2017	Added MaxLinear logo. Updated format and Ordering Information table. Changed name of Package Description section to Mechanical Dimensions and Recommended Land Pattern and Stencil per updated format. Corrected typo in Package Description / Mechanical Dimensions.
1C	May 2018	Updated Land Pattern and Stencil.

**Corporate Headquarters:**

5966 La Place Court  
Suite 100  
Carlsbad, CA 92008  
Tel.: +1 (760) 692-0711  
Fax: +1 (760) 444-8598  
[www.maxlinear.com](http://www.maxlinear.com)

**High Performance Analog:**

1060 Rincon Circle  
San Jose, CA 95131  
Tel.: +1 (669) 265-6100  
Fax: +1 (669) 265-6101  
Email: [powertechsupport@exar.com](mailto:powertechsupport@exar.com)  
[www.exar.com](http://www.exar.com)

The content of this document is furnished for informational use only, is subject to change without notice, and should not be construed as a commitment by MaxLinear, Inc.. MaxLinear, Inc. assumes no responsibility or liability for any errors or inaccuracies that may appear in the informational content contained in this guide. Complying with all applicable copyright laws is the responsibility of the user. Without limiting the rights under copyright, no part of this document may be reproduced into, stored in, or introduced into a retrieval system, or transmitted in any form or by any means (electronic, mechanical, photocopying, recording, or otherwise), or for any purpose, without the express written permission of MaxLinear, Inc.

MaxLinear, Inc. does not recommend the use of any of its products in life support applications where the failure or malfunction of the product can reasonably be expected to cause failure of the life support system or to significantly affect its safety or effectiveness. Products are not authorized for use in such applications unless MaxLinear, Inc. receives, in writing, assurances to its satisfaction that: (a) the risk of injury or damage has been minimized; (b) the user assumes all such risks; (c) potential liability of MaxLinear, Inc. is adequately protected under the circumstances.

MaxLinear, Inc. may have patents, patent applications, trademarks, copyrights, or other intellectual property rights covering subject matter in this document. Except as expressly provided in any written license agreement from MaxLinear, Inc., the furnishing of this document does not give you any license to these patents, trademarks, copyrights, or other intellectual property.

Company and product names may be registered trademarks or trademarks of the respective owners with which they are associated.

© 2016 - 2018 MaxLinear, Inc. All rights reserved

Компания «Life Electronics» занимается поставками электронных компонентов импортного и отечественного производства от производителей и со складов крупных дистрибьюторов Европы, Америки и Азии.

С конца 2013 года компания активно расширяет линейку поставок компонентов по направлению коаксиальный кабель, кварцевые генераторы и конденсаторы (керамические, пленочные, электролитические), за счёт заключения дистрибьюторских договоров

Мы предлагаем:

- Конкурентоспособные цены и скидки постоянным клиентам.
- Специальные условия для постоянных клиентов.
- Подбор аналогов.
- Поставку компонентов в любых объемах, удовлетворяющих вашим потребностям.
- Приемлемые сроки поставки, возможна ускоренная поставка.
- Доставку товара в любую точку России и стран СНГ.
- Комплексную поставку.
- Работу по проектам и поставку образцов.
- Формирование склада под заказчика.
- Сертификаты соответствия на поставляемую продукцию (по желанию клиента).
- Тестирование поставляемой продукции.
- Поставку компонентов, требующих военную и космическую приемку.
- Входной контроль качества.
- Наличие сертификата ISO.

В составе нашей компании организован Конструкторский отдел, призванный помогать разработчикам, и инженерам.

Конструкторский отдел помогает осуществить:

- Регистрацию проекта у производителя компонентов.
- Техническую поддержку проекта.
- Защиту от снятия компонента с производства.
- Оценку стоимости проекта по компонентам.
- Изготовление тестовой платы монтаж и пусконаладочные работы.



Тел: +7 (812) 336 43 04 (многоканальный)

Email: [org@lifeelectronics.ru](mailto:org@lifeelectronics.ru)