

# 1000BASE-T MAGNETICSMODULES

## Designed to Support 1:1 Turns Ratio Transceivers

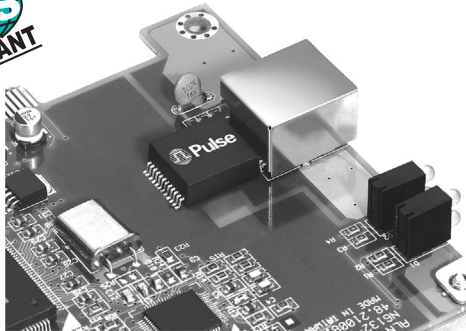

- RoHS peak reflow temperature rating 245°C
- Meets IEEE 802.3 specification

### Electrical Specifications @ 25°C — Operating Temperature 0°C to 70°C

RoHS Compliant Part Number	Number of Ports	Insertion Loss (dB MAX)	Return Loss (dB MIN)					Differential to Common Mode Rejection (dB MIN)			Crosstalk (dB MIN)			Hipot (Vrms)
			1-100 MHz	1-30 MHz	40 MHz	50 MHz	60-80 MHz	100 MHz	30 MHz	60 MHz	100 MHz	30 MHz	60 MHz	
H5004NL 3d	1	1	-18	-18	-16	-12	-10	-43	-37	-33	-43	-37	-33	1500
HX5004NL 1,3d	1	1	-18	-18	-16	-12	-10	-43	-37	-33	-43	-37	-33	1500
H5007NL 3d	1	1	-18	-18	-16	-12	-10	-43	-37	-33	-43	-37	-33	1500
H5008NL 3a	1	1	-18	-18	-16	-12	-10	-43	-37	-33	-43	-37	-33	1500
HX5008NL 1,3a	1	1	-18	-18	-16	-12	-10	-43	-37	-33	-43	-37	-33	1500
H5009NL 3a	1	1	-18	-18	-16	-12	-10	-43	-37	-33	-43	-37	-33	1500
H5012NL 3a	2	1.4	-16	-14.4	-13.1	-12	-10	-45	-40	-35	-43.5	-37.5	-33	1500
H5014NL 3a	2	1.4	-16	-14.4	-13.1	-12	-10	-45	-40	-35	-43.5	-37.5	-33	1500
HX5014NL 1,3a	2	1.4	-16	-14.4	-13.1	-12	-10	-45	-40	-35	-43.5	-37.5	-33	1500
H5015NL 3a	1	1	-18	-18	-16	-12	-10	-43	-37	-33	-43	-37	-33	1500
H5020NL 3a	2	1	-18	-14.4	-13.1	-12	-10	-40	-35	-30	-40	-33	-28	1500
HX5020NL 1,3a	2	1	-18	-14.4	-13.1	-12	-10	-40	-35	-30	-40	-33	-28	1500
H5089NL 3a	2	1.4	-16	-14.4	-13.1	-12	-10	-45	-40	-35	-43.5	-37.5	-33	1500

1. HX = extended temperature version -40°C to +85°C
2. For Tape & Reel packaging, add a "T" suffix at the end of the part number, e.g. H5007NLT.
3. MSL = Moisture Sensitivity Level: a = 1, b = 2, c = 3, d = 4

## Mechanicals

### H5004NL, HX5004NL\*, H5007NL\*

H5004NL, H5007NL, and HX5004NL are footprint-compatible to 10/100BASE-TX part H1267.

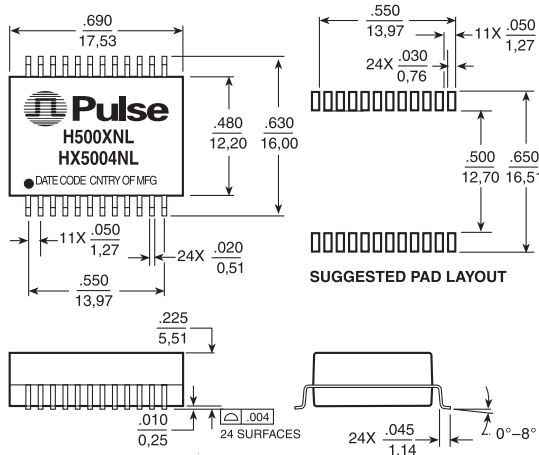

### H5008NL, H5009NL, HX5008NL

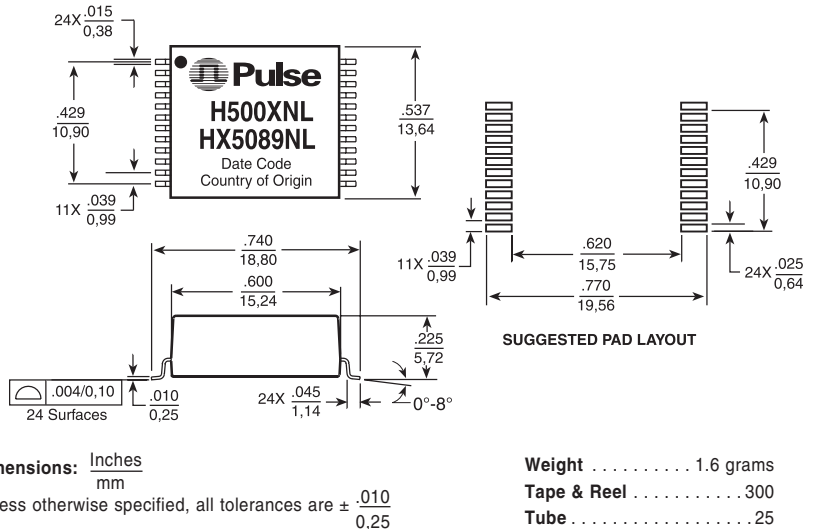

# 1000BASE-T MAGNETICSMODULES

## Designed to Support 1:1 Turns Ratio Transceivers



### Mechanicals (continued)

#### H5012NL, H5014NL, HX5014NL, H5089NL

#### H5020NL, HX5020NL

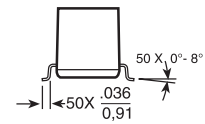
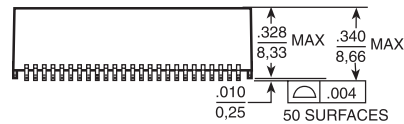
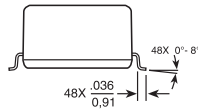
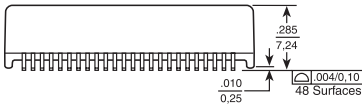
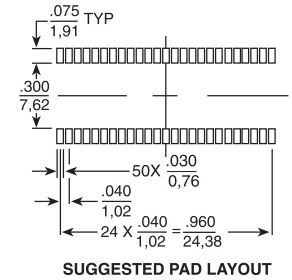
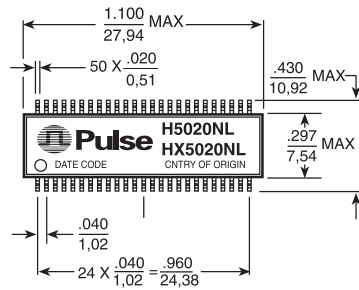
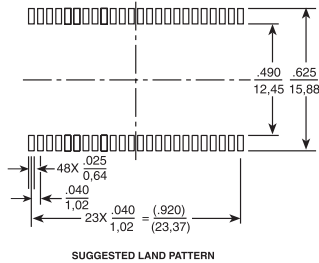
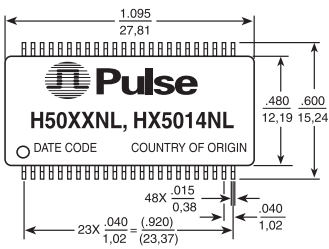

Weight . . . . . 4.0 grams  
Tape & Reel . . . . . 250/reel  
Tube . . . . . 15/tube

Dimensions:  $\frac{\text{Inches}}{\text{mm}}$   
Unless otherwise specified, all tolerances are  $\pm \frac{.010}{0.25}$

Weight . . . . . 1.6 grams  
Tape & Reel . . . . . 250/reel  
Tube . . . . . 15/tube

#### H5015NL

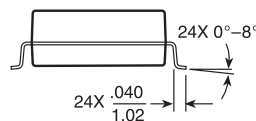
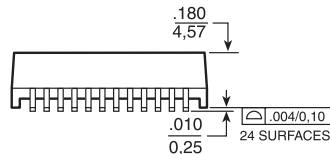
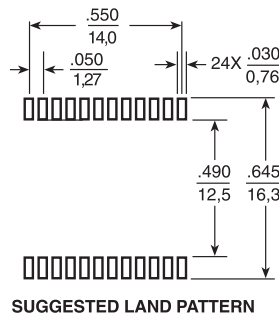
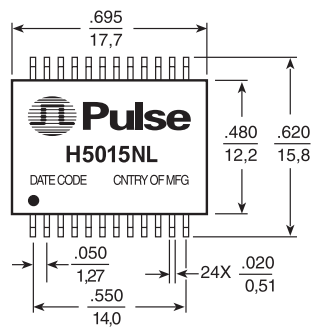

Weight . . . . . 1.5 grams  
Tape & Reel . . . . . 400/reel

Dimensions:  $\frac{\text{Inches}}{\text{mm}}$   
Unless otherwise specified, all tolerances are  $\pm \frac{.005}{0.13}$

# 1000BASE-T MAGNETICSMODULES

## Designed to Support 1:1 Turns Ratio Transceivers



### Schematics

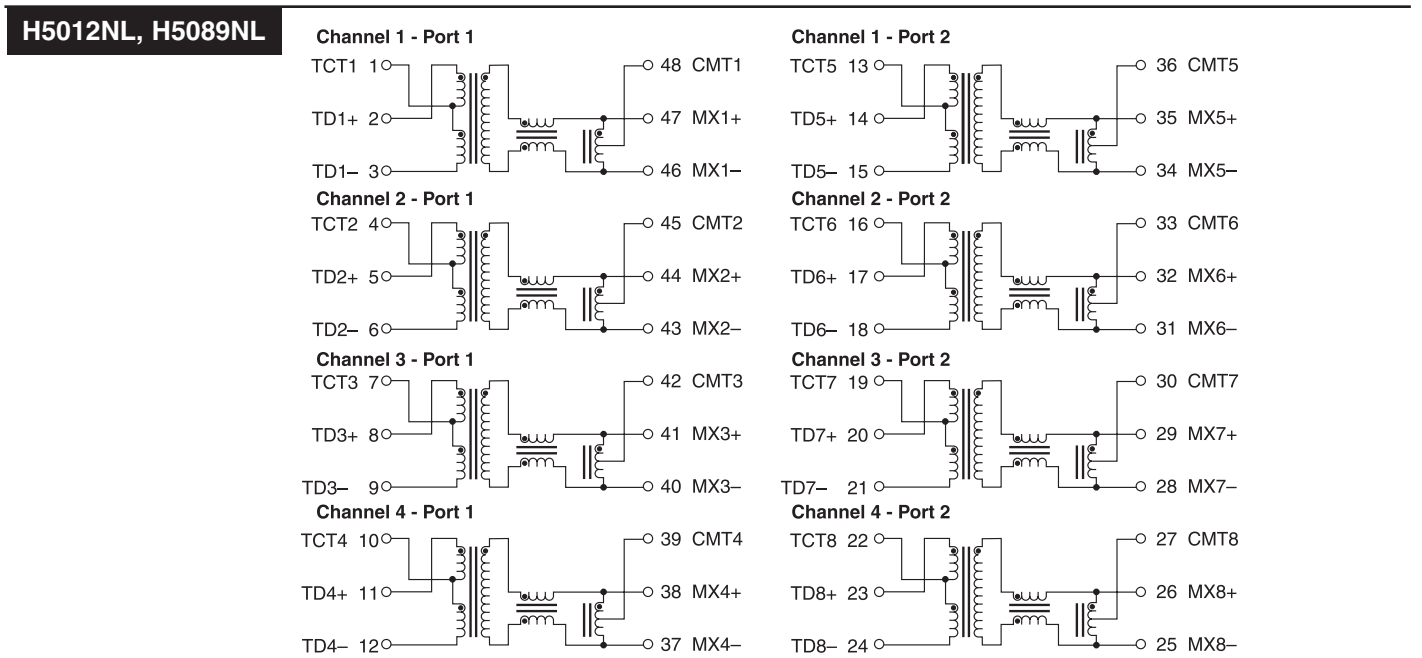
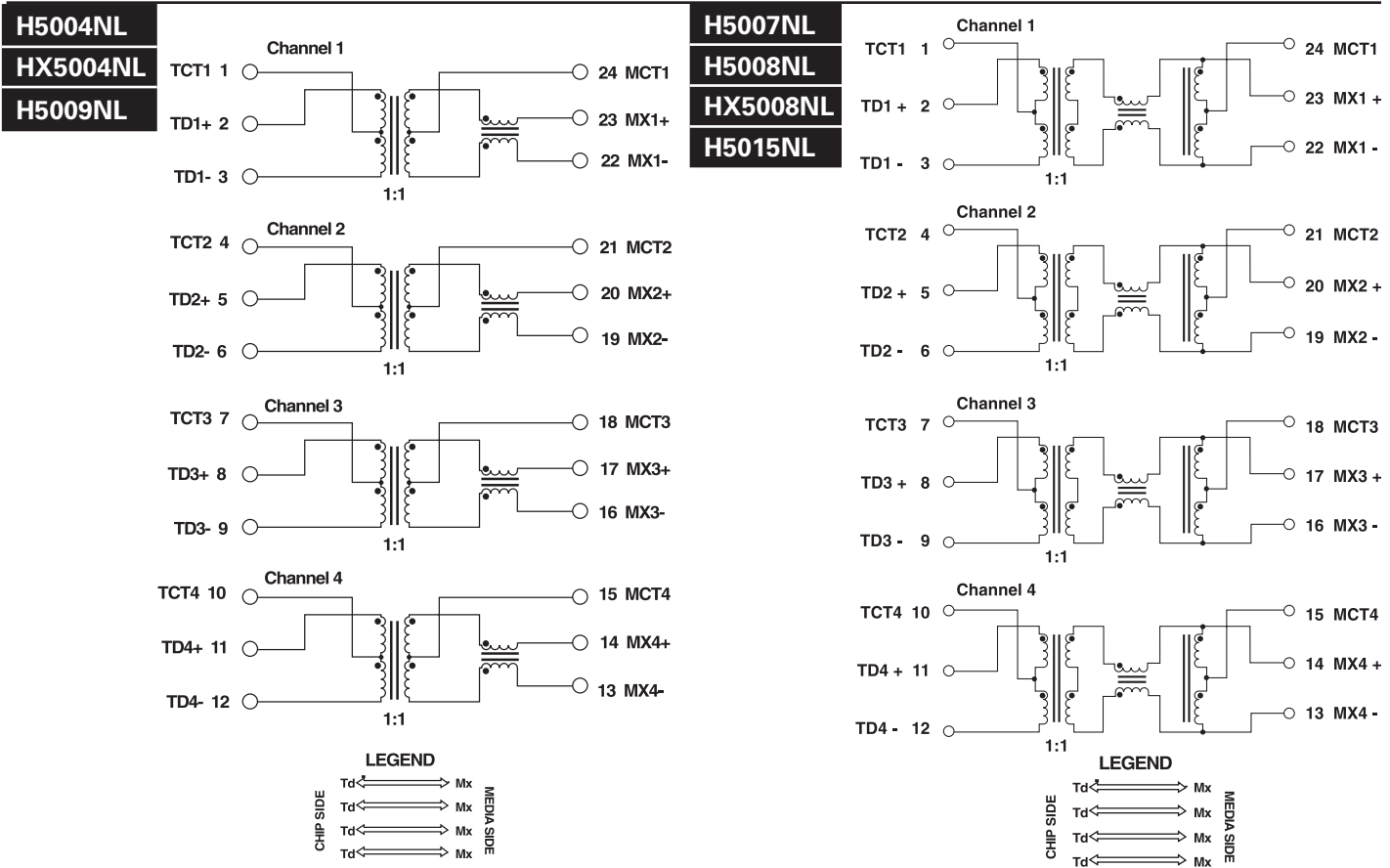

# 1000BASE-T MAGNETICSMODULES

Designed to Support 1:1  
Turns Ratio Transceivers



## Schematics (continued)

### H5014NL, HX5014NL

#### Channel 1 - Port 1

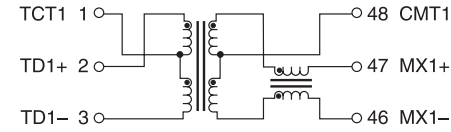

#### Channel 2 - Port 1

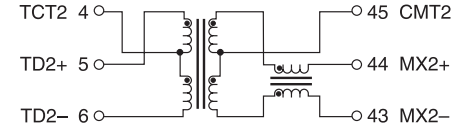

#### Channel 3 - Port 1

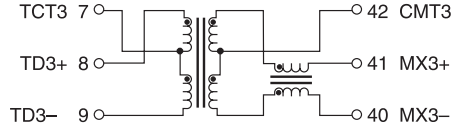

#### Channel 4 - Port 1

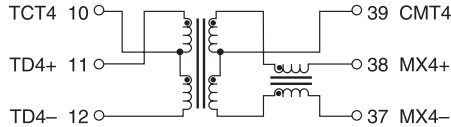

#### Channel 1 - Port 2

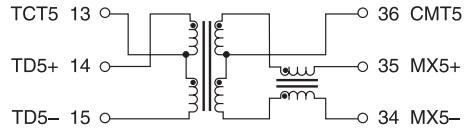

#### Channel 2 - Port 2

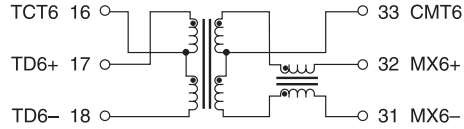

#### Channel 3 - Port 2

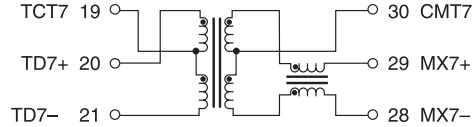

#### Channel 4 - Port 2

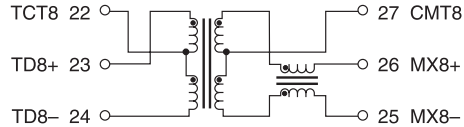

### H5020NL, HX5020NL

#### Channel 1 - Port 1

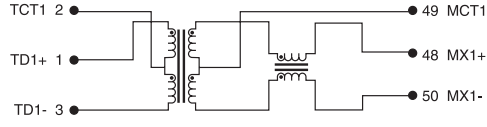

#### Channel 2 - Port 1

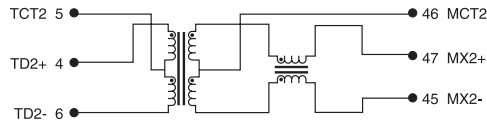

#### Channel 3 - Port 1

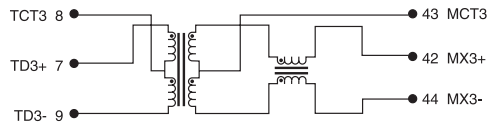

#### Channel 4 - Port 1

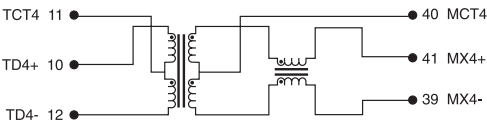

#### Channel 1 - Port 2

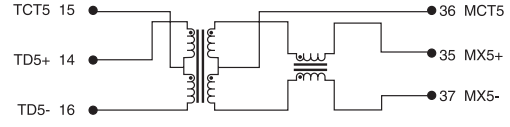

#### Channel 2 - Port 2

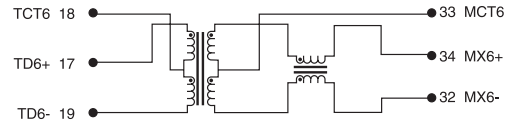

#### Channel 3 - Port 2

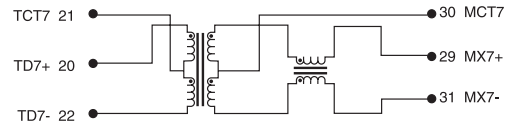

#### Channel 4 - Port 2

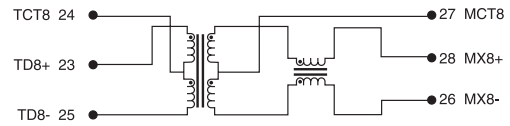

## For More Information:

### Pulse Worldwide Headquarters

12220 World Trade Dr.  
San Diego, CA 92128  
U.S.A.

[www.pulseeng.com](http://www.pulseeng.com)

Tel: 858 674 8100  
Fax: 858 674 8262

### Pulse Europe

Einsteinstrasse 1  
D-71083 Herrenberg  
Germany

Tel: 49 7032 7806 0  
Fax: 49 7032 7806 135

### Pulse China Headquarters

B402, Shenzhen Academy of  
Aerospace Technology Bldg.  
10th Kejinan Rd.  
High-Tech Zone  
Nanshan District  
Shenzhen, PR China 518057

Tel: 86 755 33966678  
Fax: 86 755 33966700

### Pulse North China

Room 2704/2705  
Super Ocean Finance Ctr.  
2067 Yan An Rd. West  
Shanghai 200336  
China

Tel: 86 21 62787060  
Fax: 86 2162786973

### Pulse South Asia

135 Joo Seng Rd.  
#03-02  
PM Industrial Bldg.  
Singapore 368363

Tel: 65 6287 8998  
Fax: 65 6287 8998

### Pulse North Asia

3F, No. 198  
Zhongyuan Rd.  
Zhongli City  
Taoyuan County 320  
Taiwan R. O. C.

Tel: 886 3 4356768  
Fax: FRE 886 3 4356820  
Pulse: 886 3 4356823

Performance warranty of products offered on this data sheet is limited to the parameters specified. Data is subject to change without notice. Other brand and product names mentioned herein may be trademarks or registered trademarks of their respective owners.

© Copyright, 2010. Pulse Engineering, Inc. All rights reserved.

Компания «Life Electronics» занимается поставками электронных компонентов импортного и отечественного производства от производителей и со складов крупных дистрибьюторов Европы, Америки и Азии.

С конца 2013 года компания активно расширяет линейку поставок компонентов по направлению коаксиальный кабель, кварцевые генераторы и конденсаторы (керамические, пленочные, электролитические), за счёт заключения дистрибьюторских договоров

Мы предлагаем:

- Конкуренспособные цены и скидки постоянным клиентам.
- Специальные условия для постоянных клиентов.
- Подбор аналогов.
- Поставку компонентов в любых объемах, удовлетворяющих вашим потребностям.
- Приемлемые сроки поставки, возможна ускоренная поставка.
- Доставку товара в любую точку России и стран СНГ.
- Комплексную поставку.
- Работу по проектам и поставку образцов.
- Формирование склада под заказчика.
- Сертификаты соответствия на поставляемую продукцию (по желанию клиента).
- Тестирование поставляемой продукции.
- Поставку компонентов, требующих военную и космическую приемку.
- Входной контроль качества.
- Наличие сертификата ISO.

В составе нашей компании организован Конструкторский отдел, призванный помогать разработчикам, и инженерам.

Конструкторский отдел помогает осуществить:

- Регистрацию проекта у производителя компонентов.
- Техническую поддержку проекта.
- Защиту от снятия компонента с производства.
- Оценку стоимости проекта по компонентам.
- Изготовление тестовой платы монтаж и пусконаладочные работы.



Тел: +7 (812) 336 43 04 (многоканальный)

Email: [org@lifeelectronics.ru](mailto:org@lifeelectronics.ru)