

Low-power, rail-to-rail output, 36 V operational amplifier

Datasheet - production data

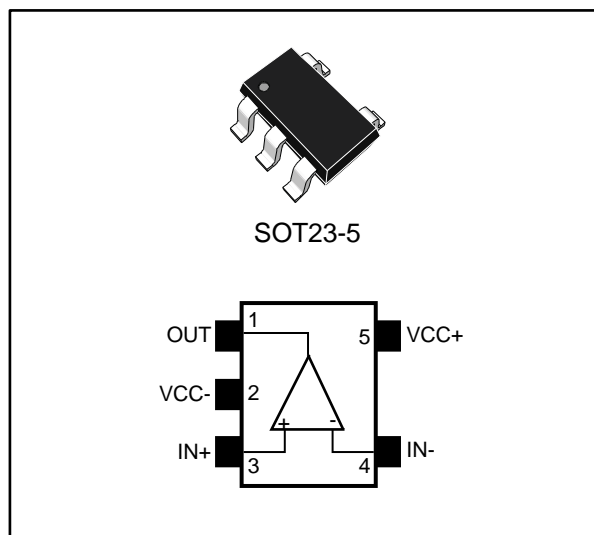

Applications

- Industrial
- Power supplies
- Automotive

Description

The TSB611 single operational amplifier (op amp) offers an extended supply voltage operating range and rail-to-rail output. It also offers an excellent speed/power consumption ratio with 560 kHz gain bandwidth product while consuming less than 125 μA at 36 V supply voltage.

The TSB611 operates over a wide temperature range from $-40\text{ }^{\circ}\text{C}$ to $125\text{ }^{\circ}\text{C}$ making this device ideal for industrial and automotive applications.

Thanks to its small package size, the TSB611 can be used in applications where space on the board is limited. It can thus reduce the overall cost of the PCB.

Features

- Low offset voltage: 1 mV max
- Low power consumption: 125 μA max. at 36 V
- Wide supply voltage: 2.7 to 36 V
- Gain bandwidth product: 560 kHz typ
- Unity gain stable
- Rail-to-rail output
- Input common mode voltage includes ground
- High tolerance to ESD: 4 kV HBM
- Extended temperature range: $-40\text{ }^{\circ}\text{C}$ to $125\text{ }^{\circ}\text{C}$
- Automotive qualification

Contents

1 Absolute maximum ratings and operating conditions 3

2 Electrical characteristics 4

3 Application information 13

 3.1 Operating voltages 13

 3.2 Input common-mode range 13

 3.3 Rail-to-rail output..... 13

 3.4 Input offset voltage drift over temperature..... 13

 3.5 Long term input offset voltage drift 13

 3.6 ESD structure of TSB611 15

 3.7 Initialization time..... 16

4 Package information 17

 4.1 SOT23-5 package information 18

5 Ordering information..... 19

6 Revision history 20



1 Absolute maximum ratings and operating conditions

Table 1: Absolute maximum ratings (AMR)

Symbol	Parameter	Value	Unit
V _{cc}	Supply voltage ⁽¹⁾	40	V
V _{id}	Differential input voltage ⁽²⁾	±V _{cc}	
V _{in}	Input voltage	(V _{cc-}) - 0.2 to (V _{cc+}) + 0.2	
I _{in}	Input current ⁽³⁾	10	mA
T _{stg}	Storage temperature	-65 to 150	°C
R _{thja}	Thermal resistance junction to ambient ⁽⁴⁾⁽⁵⁾	250	°C/W
T _j	Maximum junction temperature	150	°C
ESD	HBM: human body model ⁽⁶⁾	4000	V
	MM: machine model ⁽⁷⁾	200	
	CDM: charged device model ⁽⁸⁾	1500	
	Latch-up immunity	200	mA

Notes:

- ⁽¹⁾All voltage values, except differential voltage are with respect to network ground terminal.
⁽²⁾Differential voltages are the non-inverting input terminal with respect to the inverting input terminal.
⁽³⁾Input current must be limited by a resistor in series with the inputs.
⁽⁴⁾R_{th} are typical values.
⁽⁵⁾Short-circuits can cause excessive heating and destructive dissipation.
⁽⁶⁾According to JEDEC standard JESD22-A114F.
⁽⁷⁾According to JEDEC standard JESD22-A115A.
⁽⁸⁾According to ANSI/ESD STM5.3.1.

Table 2: Operating conditions

Symbol	Parameter	Value	Unit
V _{cc}	Supply voltage	2.7 to 36	V
V _{icm}	Common mode input voltage range	(V _{cc-}) - 0.1 to (V _{cc+}) - 1	
T _{oper}	Operating free air temperature range	-40 to 125	°C

2 Electrical characteristics

Table 3: Electrical characteristics at $V_{CC+} = 2.7\text{ V}$ with $V_{CC-} = 0\text{ V}$, $V_{icm} = V_{CC}/2$, $T_{amb} = 25\text{ }^{\circ}\text{C}$, and $R_L = 10\text{ k}\Omega$ connected to $V_{CC}/2$ (unless otherwise specified)

Symbol	Parameter	Conditions	Min.	Typ.	Max.	Unit
DC performance						
V_{io}	Input offset voltage		-1		1	mV
		$-40\text{ }^{\circ}\text{C} < T < 125\text{ }^{\circ}\text{C}$	-1.6		1.6	
$\Delta V_{io}/\Delta T$	Input offset voltage drift	$-40\text{ }^{\circ}\text{C} < T < 125\text{ }^{\circ}\text{C}$		1.8	6	$\mu\text{V}/^{\circ}\text{C}$
I_{io}	Input offset current			1	5	nA
		$-40\text{ }^{\circ}\text{C} < T < 125\text{ }^{\circ}\text{C}$			10	
I_{ib}	Input bias current			5	10	nA
		$-40\text{ }^{\circ}\text{C} < T < 125\text{ }^{\circ}\text{C}$			15	
CMR	Common mode rejection ratio: $20 \log (\Delta V_{icm}/\Delta V_{io})$	$V_{icm} = 0\text{ V to } V_{CC+} - 1\text{ V}$, $V_{out} = V_{CC}/2$	90	115		dB
		$-40\text{ }^{\circ}\text{C} < T < 125\text{ }^{\circ}\text{C}$	85			
A_{vd}	Large signal voltage gain	$V_{out} = 0.5\text{ V to } (V_{CC+} - 0.5\text{ V})$	98	102		dB
		$-40\text{ }^{\circ}\text{C} < T < 125\text{ }^{\circ}\text{C}$	94			
V_{OH}	High level output voltage (voltage drop from V_{CC+})			13	25	mV
		$-40\text{ }^{\circ}\text{C} < T < 125\text{ }^{\circ}\text{C}$			30	
V_{OL}	Low level output voltage			26	30	mV
		$-40\text{ }^{\circ}\text{C} < T < 125\text{ }^{\circ}\text{C}$			35	
I_{out}	I_{sink}	$V_{out} = V_{CC}$	13	20		mA
		$-40\text{ }^{\circ}\text{C} < T < 125\text{ }^{\circ}\text{C}$	10			
	I_{source}	$V_{out} = 0\text{ V}$	20	28		
		$-40\text{ }^{\circ}\text{C} < T < 125\text{ }^{\circ}\text{C}$	7			
I_{CC}	Supply current (per channel)	No load, $V_{out} = V_{CC}/2$		92	110	μA
		$-40\text{ }^{\circ}\text{C} < T < 125\text{ }^{\circ}\text{C}$			125	
AC performance						
GBP	Gain bandwidth product	$R_L = 10\text{ k}\Omega$, $C_L = 100\text{ pF}$		480		kHz
F_u	Unity gain frequency	$R_L = 10\text{ k}\Omega$, $C_L = 100\text{ pF}$		430		
ϕ_m	Phase margin	$R_L = 10\text{ k}\Omega$, $C_L = 100\text{ pF}$		60		Degrees
G_m	Gain margin	$R_L = 10\text{ k}\Omega$, $C_L = 100\text{ pF}$		18		dB
SR+	Positive slew rate	$R_L = 10\text{ k}\Omega$, $C_L = 100\text{ pF}$, $V_{out} = 0.5\text{ V to } V_{CC} - 0.5\text{ V}$	0.13	0.18		V/ μs
SR-	Negative slew rate	$R_L = 10\text{ k}\Omega$, $C_L = 100\text{ pF}$, $V_{out} = 0.5\text{ V to } V_{CC} - 0.5\text{ V}$	0.10	0.14		
e_n	Equivalent input noise voltage	$f = 1\text{ kHz}$		37		nV/ $\sqrt{\text{Hz}}$
		$f = 10\text{ kHz}$		32		
THD+N	Total harmonic distortion + noise	$f_{in} = 1\text{ kHz}$, Gain = 1, $R_L = 100\text{ k}\Omega$, $V_{icm} = (V_{CC} - 1\text{ V})/2$, BW = 22 kHz, $V_{out} = 1\text{ V}_{pp}$		0.005		%

Symbol	Parameter	Conditions	Min.	Typ.	Max.	Unit
t_{rec}	Overload recovery time			2		μs

Table 4: Electrical characteristics at $V_{cc+} = 12 V$ with $V_{cc-} = 0 V$, $V_{icm} = V_{cc}/2$, $T_{amb} = 25 ^\circ C$, and $R_L = 10 k\Omega$ connected to $V_{cc}/2$ (unless otherwise specified)

Symbol	Parameter	Conditions	Min.	Typ.	Max.	Unit
DC performance						
V_{io}	Input offset voltage		-1		1	mV
		$-40 ^\circ C < T < 125 ^\circ C$	-1.6		1.6	
$\Delta V_{io}/\Delta T$	Input offset voltage drift	$-40 ^\circ C < T < 125 ^\circ C$		1.6	6	$\mu V/^\circ C$
I_{io}	Input offset current			1	5	nA
		$-40 ^\circ C < T < 125 ^\circ C$			15	
I_{ib}	Input bias current			5	10	nA
		$-40 ^\circ C < T < 125 ^\circ C$			15	
CMR	Common mode rejection ratio: $20 \log (\Delta V_{icm}/\Delta V_{io})$	$V_{icm} = 0 V$ to $V_{cc+} - 1 V$, $V_{out} = V_{cc}/2$	95	126		dB
		$-40 ^\circ C < T < 125 ^\circ C$	90			
SVR	Supply voltage rejection ratio: $20 \log (\Delta V_{cc}/\Delta V_{io})$	$V_{cc} = 2.8$ to $12 V$	95	124		dB
		$-40 ^\circ C < T < 125 ^\circ C$	90			
A_{vd}	Large signal voltage gain	$V_{out} = 0.5 V$ to $(V_{cc+} - 0.5 V)$	105	115		dB
		$-40 ^\circ C < T < 125 ^\circ C$	100			
V_{OH}	High level output voltage drop from V_{cc+}			37	60	mV
		$-40 ^\circ C < T < 125 ^\circ C$			65	
V_{OL}	Low level output voltage			56	65	mV
		$-40 ^\circ C < T < 125 ^\circ C$			75	
I_{out}	I_{sink}	$V_{out} = V_{cc}$	24	35		mA
		$-40 ^\circ C < T < 125 ^\circ C$	10			
	I_{source}	$V_{out} = 0 V$	28	40		
		$-40 ^\circ C < T < 125 ^\circ C$	10			
I_{CC}	Supply current (per channel)	No load, $V_{out} = V_{cc}/2$		97	115	μA
		$-40 ^\circ C < T < 125 ^\circ C$			130	
AC performance						
GBP	Gain bandwidth product	$R_L = 10 k\Omega$, $C_L = 100 pF$		510		kHz
F_u	Unity gain frequency	$R_L = 10 k\Omega$, $C_L = 100 pF$		460		
ϕ_m	Phase margin	$R_L = 10 k\Omega$, $C_L = 100 pF$		60		Degrees
G_m	Gain margin	$R_L = 10 k\Omega$, $C_L = 100 pF$		18		dB
SR+	Positive slew rate	$R_L = 10 k\Omega$, $C_L = 100 pF$, $V_{out} = 0.5 V$ to $V_{CC} - 0.5 V$	0.13	0.19		V/ μs
SR-	Negative slew rate	$R_L = 10 k\Omega$, $C_L = 100 pF$, $V_{out} = 0.5 V$ to $V_{CC} - 0.5 V$	0.11	0.15		
e_n	Equivalent input noise voltage	$f = 1 kHz$		31		nV/ \sqrt{Hz}
		$f = 10 kHz$		30		

Symbol	Parameter	Conditions	Min.	Typ.	Max.	Unit
THD+N	Total harmonic distortion + noise	$f_{in} = 1 \text{ kHz}$, Gain = 1, $R_L = 100 \text{ k}\Omega$, $V_{icm} = (V_{cc} - 1 \text{ V})/2$, BW = 22 kHz, $V_{out} = 2 V_{pp}$		0.004		%
t_{rec}	Overload recovery time			2		μs

Table 5: Electrical characteristics at $V_{cc+} = 36 \text{ V}$ with $V_{cc-} = 0 \text{ V}$, $V_{icm} = V_{cc}/2$, $T_{amb} = 25 \text{ }^\circ\text{C}$, and $R_L = 10 \text{ k}\Omega$ connected to $V_{cc}/2$ (unless otherwise specified)

Symbol	Parameter	Conditions	Min.	Typ.	Max.	Unit
DC performance						
V_{io}	Input offset voltage		-1		1	mV
		$-40 \text{ }^\circ\text{C} < T < 125 \text{ }^\circ\text{C}$	-1.6		1.6	
$\Delta V_{io}/\Delta T$	Input offset voltage drift	$-40 \text{ }^\circ\text{C} < T < 125 \text{ }^\circ\text{C}$		1.3	6	$\mu\text{V}/^\circ\text{C}$
I_{io}	Input offset current			1	5	nA
		$-40 \text{ }^\circ\text{C} < T < 125 \text{ }^\circ\text{C}$			20	
I_{ib}	Input bias current			5	10	nA
		$-40 \text{ }^\circ\text{C} < T < 125 \text{ }^\circ\text{C}$			20	
CMR	Common mode rejection ratio: $20 \log (\Delta V_{icm}/\Delta V_{io})$	$V_{icm} = 0 \text{ V to } V_{cc+} - 1 \text{ V}$, $V_{out} = V_{cc}/2$	105	130		dB
		$-40 \text{ }^\circ\text{C} < T < 125 \text{ }^\circ\text{C}$	100			
SVR	Supply voltage rejection ratio $20 \log (\Delta V_{cc}/\Delta V_{io})$	$V_{cc} = 12 \text{ to } 36 \text{ V}$	100	124		dB
		$-40 \text{ }^\circ\text{C} < T < 125 \text{ }^\circ\text{C}$	95			
A_{vd}	Large signal voltage gain	$V_{out} = 0.5 \text{ V to } (V_{cc+} - 0.5 \text{ V})$	110	120		dB
		$-40 \text{ }^\circ\text{C} < T < 125 \text{ }^\circ\text{C}$	105			
V_{OH}	High level output voltage drop from V_{cc+}			80	110	mV
		$-40 \text{ }^\circ\text{C} < T < 125 \text{ }^\circ\text{C}$			150	
V_{OL}	Low level output voltage			90	110	mV
		$-40 \text{ }^\circ\text{C} < T < 125 \text{ }^\circ\text{C}$			150	
I_{out}	I_{sink}	$V_{out} = V_{cc}$	40	60		mA
		$-40 \text{ }^\circ\text{C} < T < 125 \text{ }^\circ\text{C}$	10			
	I_{source}	$V_{out} = 0 \text{ V}$	40	70		
		$-40 \text{ }^\circ\text{C} < T < 125 \text{ }^\circ\text{C}$	20			
I_{cc}	Supply current (per channel)	No load, $V_{out} = V_{cc}/2$		103	125	μA
		$-40 \text{ }^\circ\text{C} < T < 125 \text{ }^\circ\text{C}$			140	
AC performance						
GBP	Gain bandwidth product	$R_L = 10 \text{ k}\Omega$, $C_L = 100 \text{ pF}$		560		kHz
F_u	Unity gain frequency	$R_L = 10 \text{ k}\Omega$, $C_L = 100 \text{ pF}$		500		
ϕ_m	Phase margin	$R_L = 10 \text{ k}\Omega$, $C_L = 100 \text{ pF}$		58		Degrees
G_m	Gain margin	$R_L = 10 \text{ k}\Omega$, $C_L = 100 \text{ pF}$		18		dB
SR+	Positive slew rate	$R_L = 10 \text{ k}\Omega$, $C_L = 100 \text{ pF}$, $V_{out} = 0.5 \text{ V to } V_{cc} - 0.5 \text{ V}$	0.15	0.20		V/ μs

Symbol	Parameter	Conditions	Min.	Typ.	Max.	Unit
SR-	Negative slew rate	$R_L = 10\text{ k}\Omega$, $C_L = 100\text{ pF}$, $V_{out} = 0.5\text{ V to }V_{CC} - 0.5\text{ V}$	0.12	0.16		
e_n	Equivalent input noise voltage	$f = 1\text{ kHz}$		29		nV/ $\sqrt{\text{Hz}}$
		$f = 10\text{ kHz}$		28		
THD+N	Total harmonic distortion + noise	$f_{in} = 1\text{ kHz}$, Gain = 1, $R_L = 100\text{ k}\Omega$, $V_{icm} = (V_{CC} - 1\text{ V})/2$, BW = 22 kHz, $V_{out} = 2\text{ V}_{pp}$		0.004		%
t_{rec}	Overload recovery time	$R_L = 10\text{ k}\Omega$, $C_L = 100\text{ pF}$, Gain = 1		2		μs

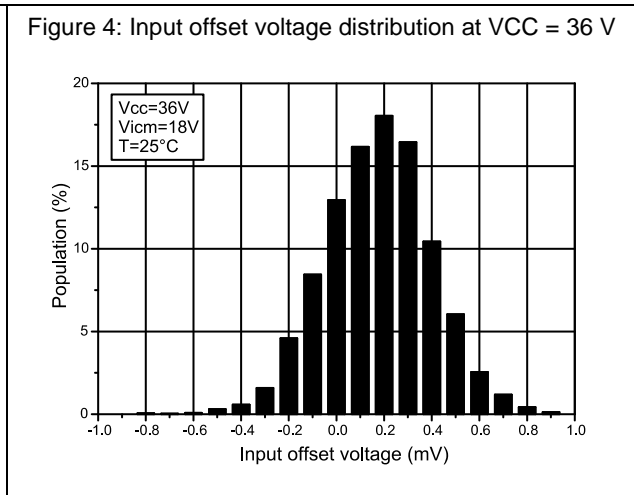
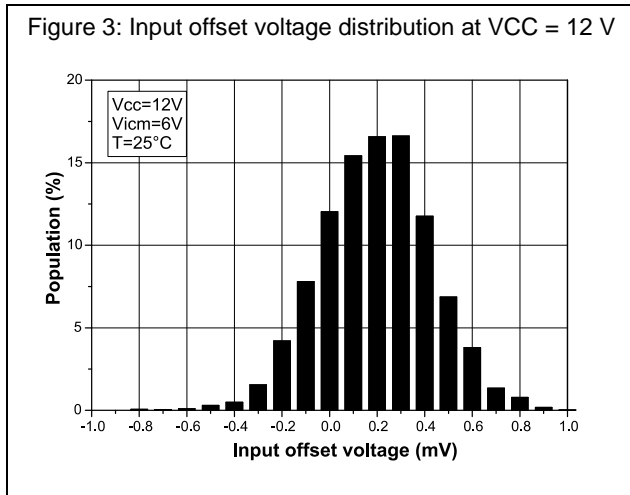
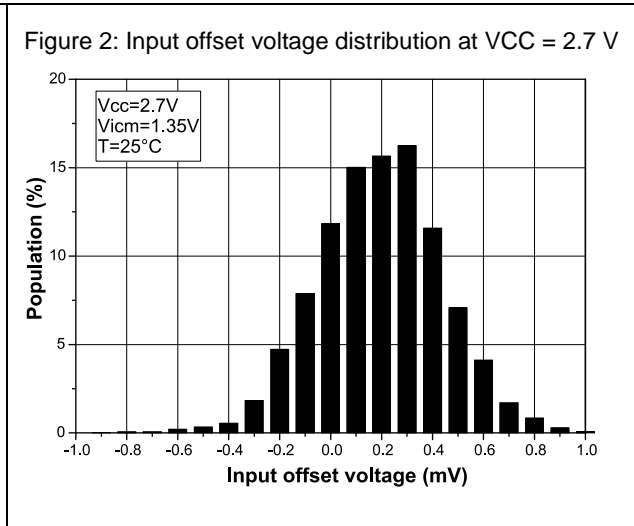
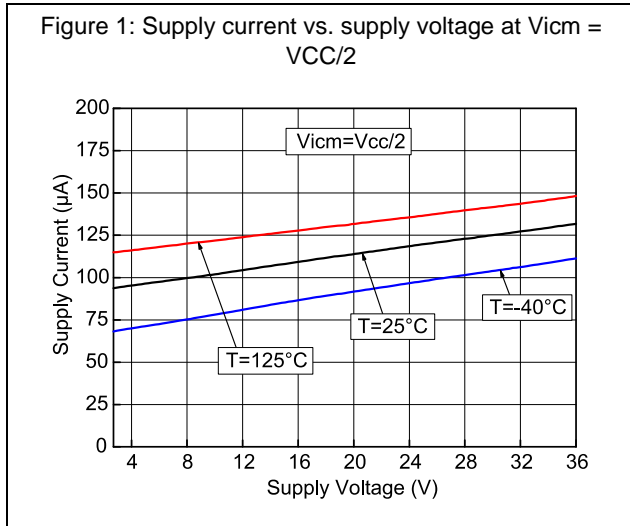

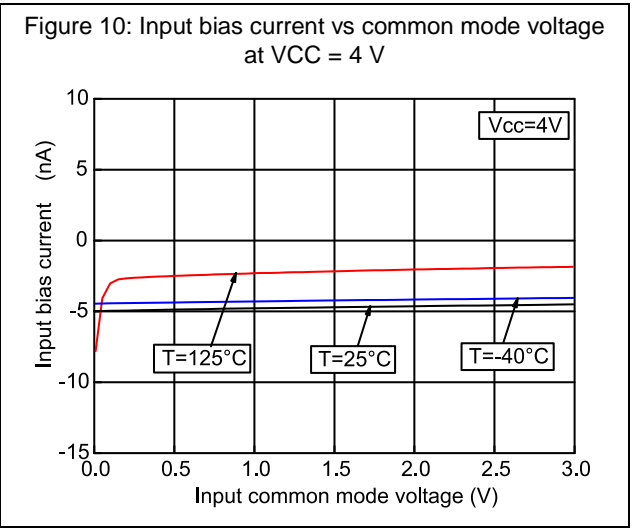
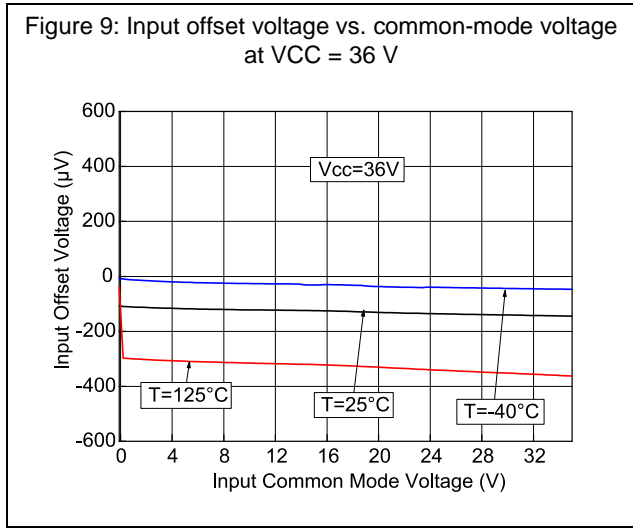
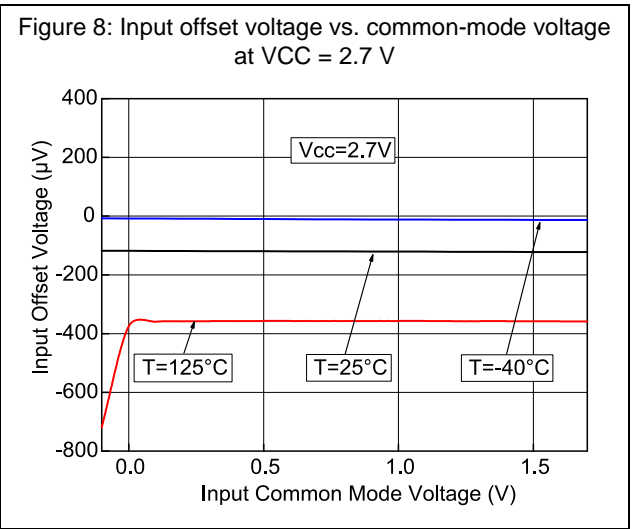
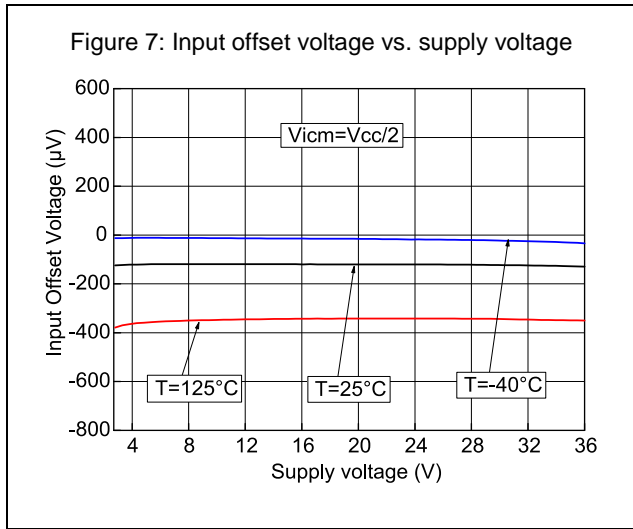
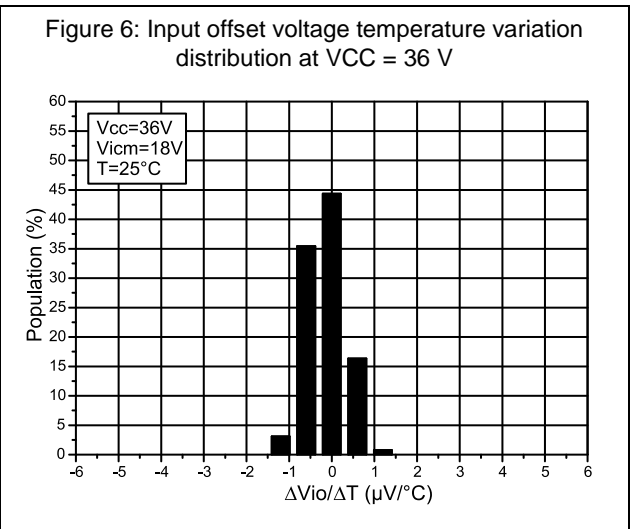
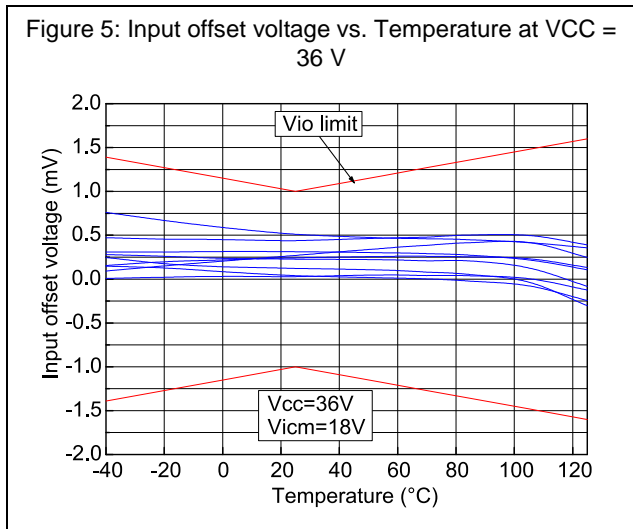

Figure 11: Input bias current vs common mode voltage at VCC = 36 V

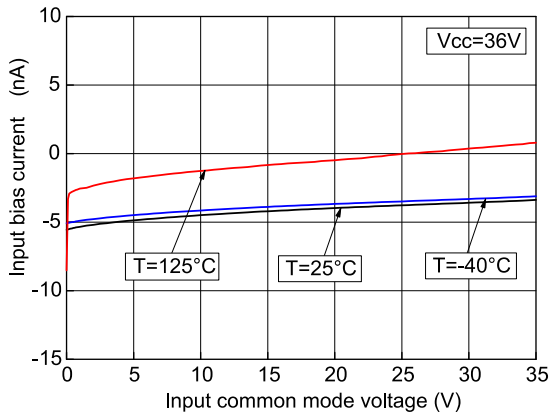

Figure 12: Output current vs. output voltage at VCC = 2.7 V

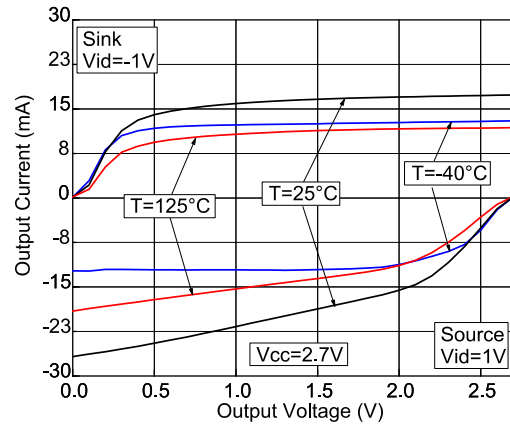

Figure 13: Output current vs. output voltage at VCC = 36 V

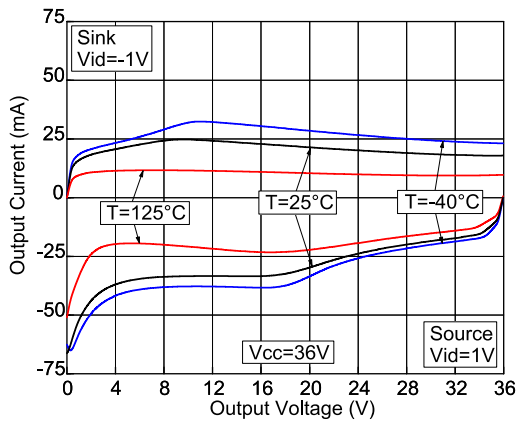

Figure 14: Output voltage (Voh) vs. supply voltage

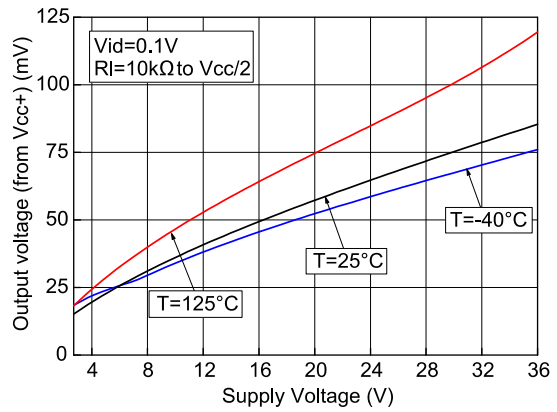

Figure 15: Output voltage (Vol) vs. supply voltage

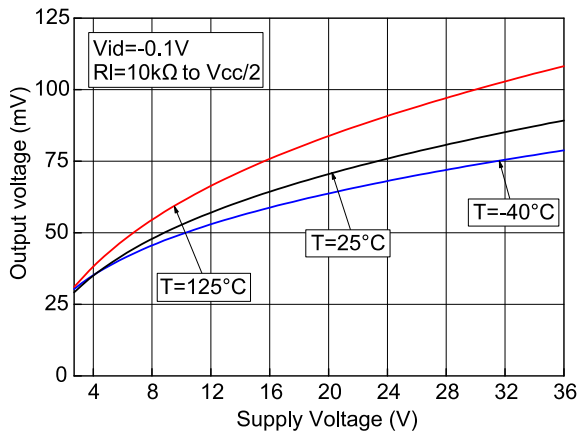

Figure 16: Amplifier behavior close to negative rail at VCC = 5 V

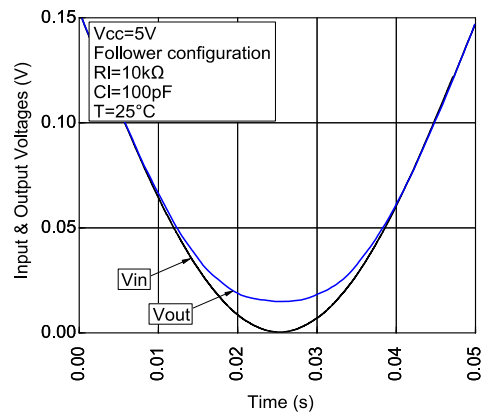

Figure 17: Amplifier behavior close to positive rail at VCC = 5 V

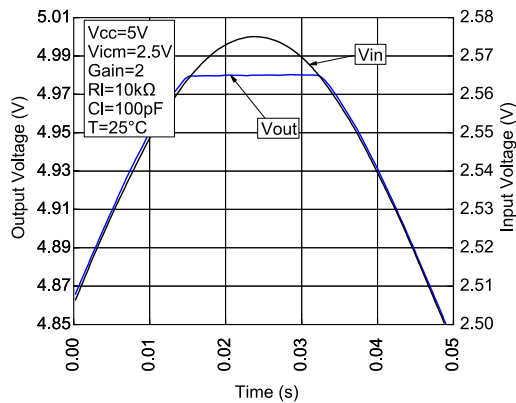

Figure 18: Slew rate vs. supply voltage

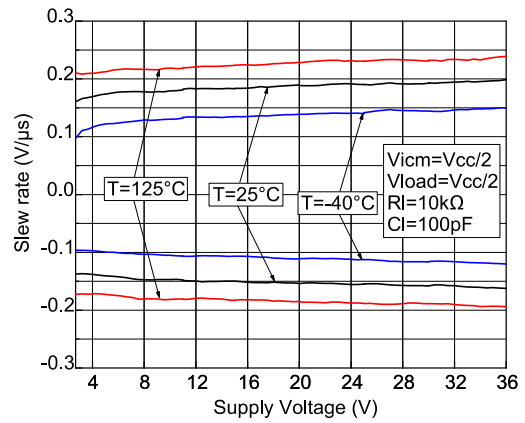

Figure 19: Negative slew rate behavior vs. temperature at VCC = 36 V

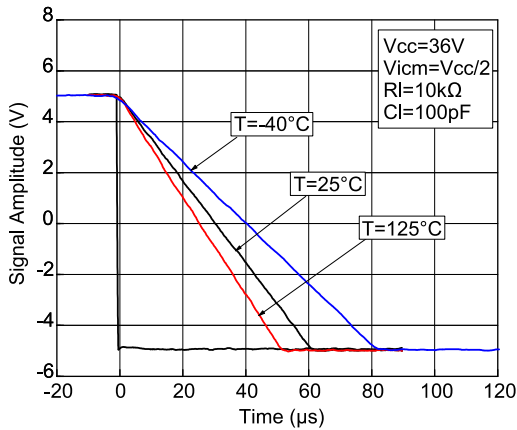

Figure 20: Positive slew rate behavior vs. temperature at VCC = 36 V

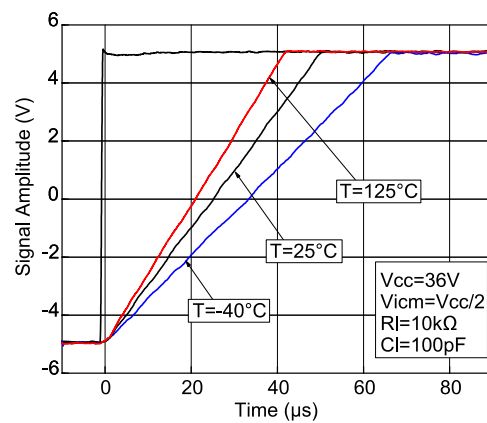

Figure 21: Small step response vs. time at VCC = 36 V

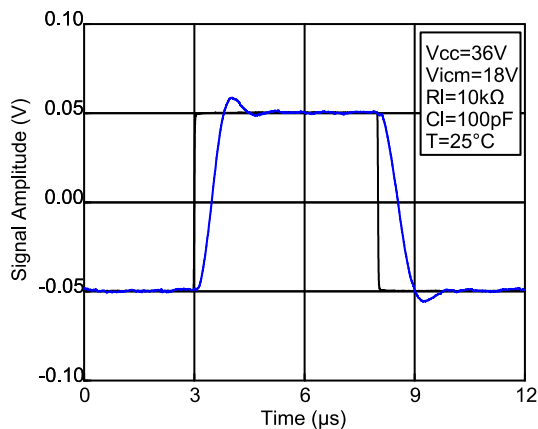

Figure 22: Output desaturation vs. time

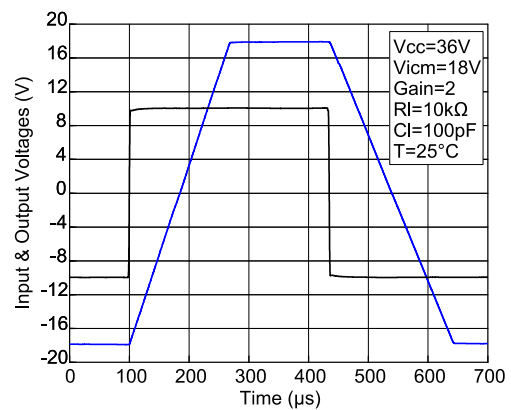

Figure 23: Gain and phase vs. frequency at VCC = 2.7 V

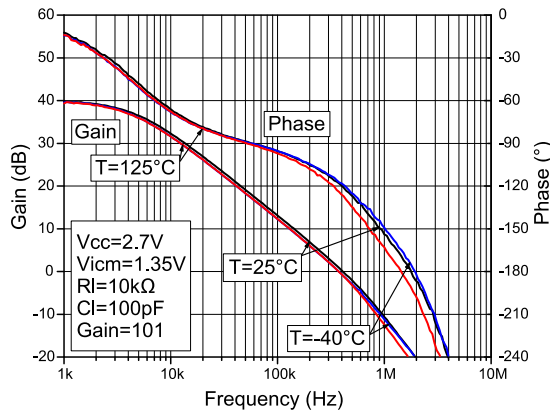

Figure 24: Gain and phase vs. frequency at VCC = 36 V

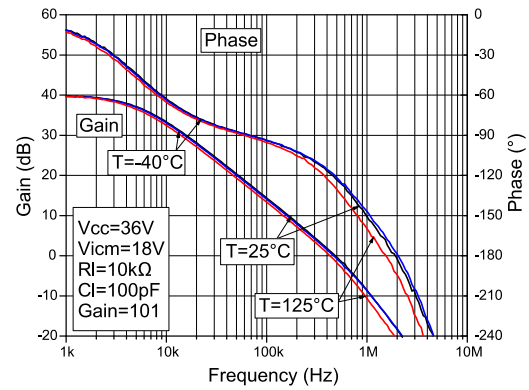

Figure 25: Phase margin vs. output current at VCC = 2.7 V and 36 V

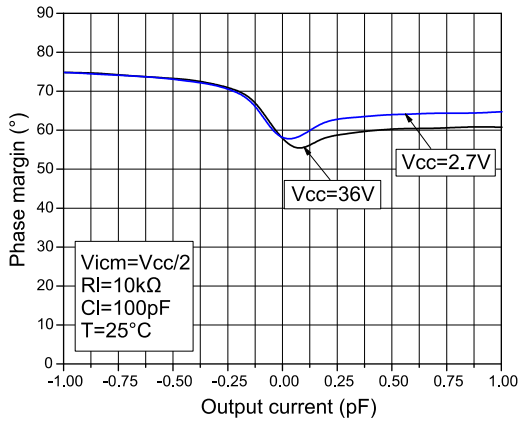

Figure 26: Phase margin vs. capacitive load at VCC = 2.7 V and 36 V

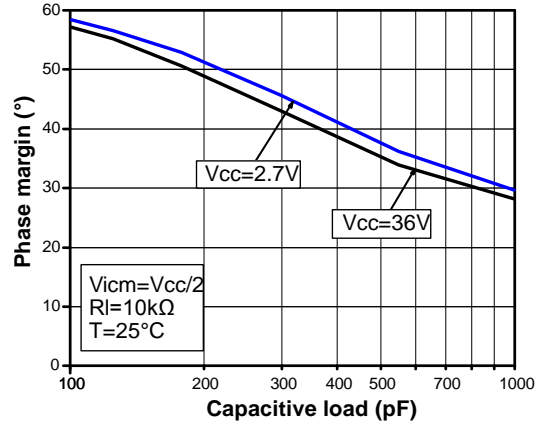

Figure 27: Overshoot vs. capacitive load at VCC = 2.7 V and 36 V

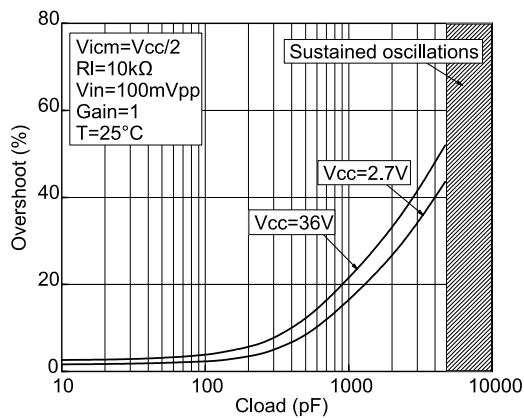
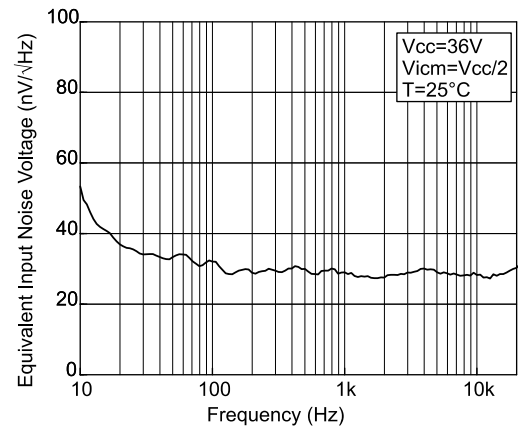
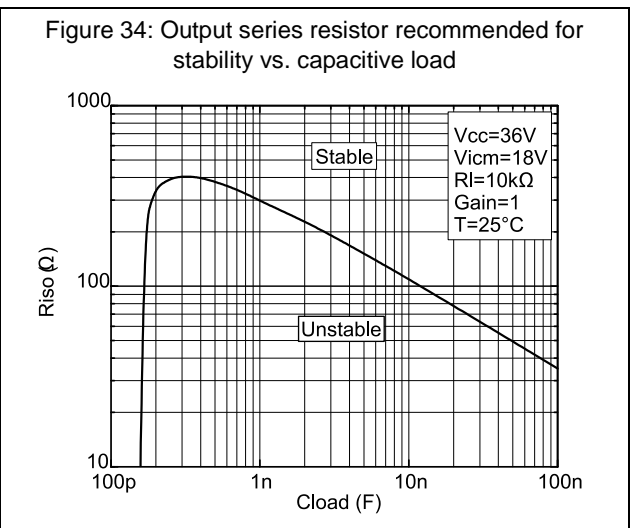
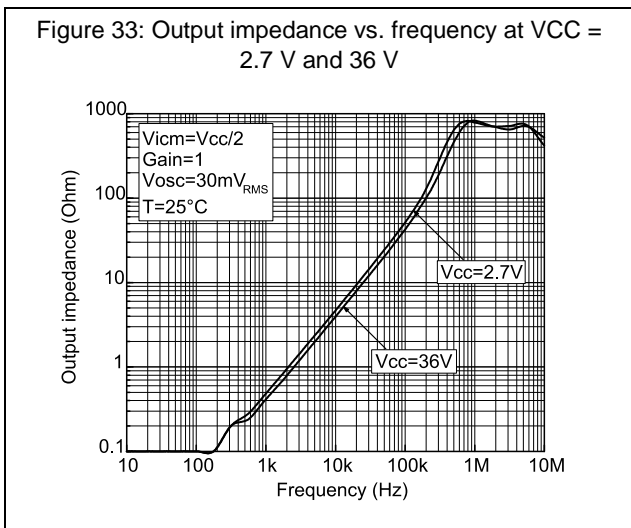
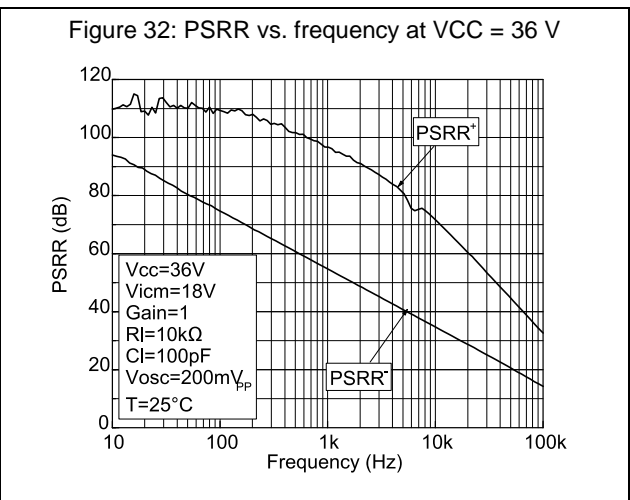
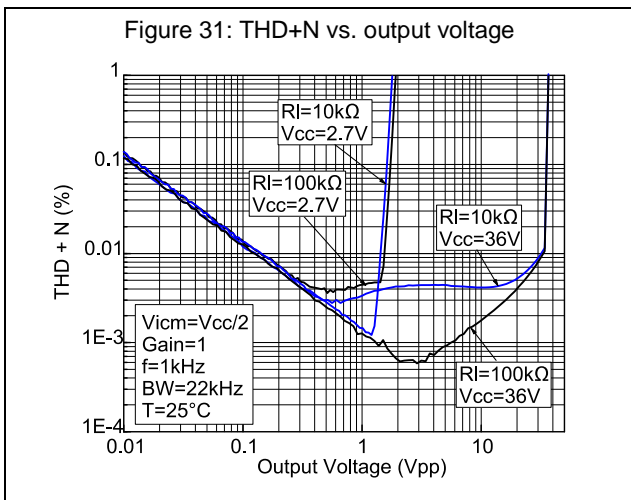
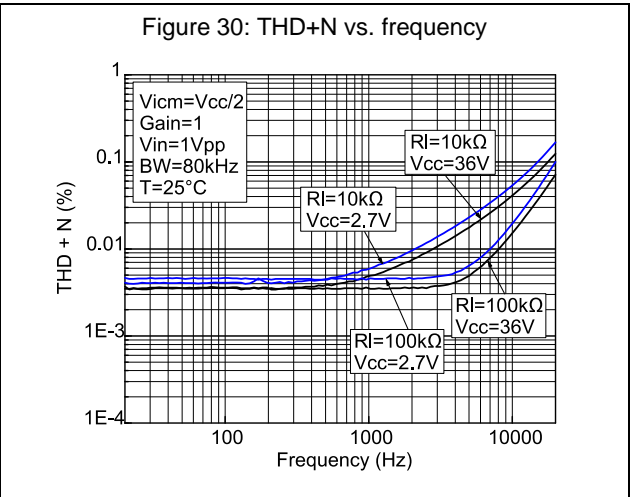
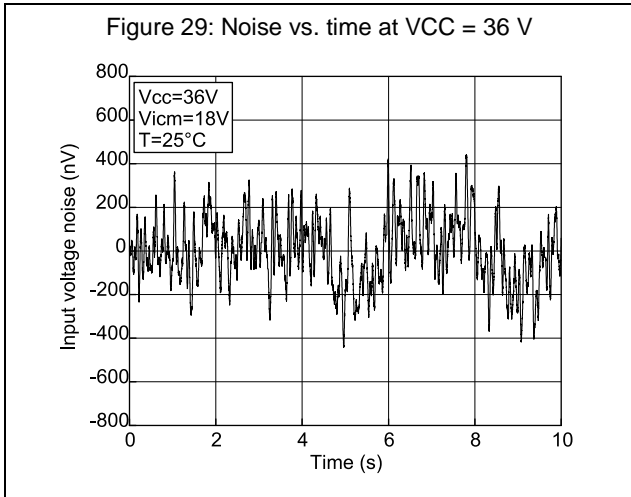

Figure 28: Noise vs. frequency at VCC = 36 V





3 Application information

3.1 Operating voltages

The TSB611 operational amplifier can operate from 2.7 V to 36 V. The parameters are fully specified at 2.7 V, 12 V, and 36 V power supplies. However, parameters are very stable in the full V_{CC} range. Additionally, main specifications are guaranteed in the extended temperature range from -40 to 125 °C.

3.2 Input common-mode range

The TSB611 has an input common-mode range that includes ground. The input common-mode range is extended from $(V_{CC-}) - 0.1$ V to $(V_{CC+}) - 1$ V.

3.3 Rail-to-rail output

The operational amplifier's output levels can go close to the rails: 100 mV maximum below the positive rail and 110 mV maximum above the negative rail when connected to a 10 kΩ resistive load to $V_{CC}/2$ for a power supply voltage of 36 V.

3.4 Input offset voltage drift over temperature

The maximum input voltage drift variation over temperature is defined as the offset variation related to the offset value measured at 25 °C. The operational amplifier is one of the main circuits of the signal conditioning chain, and the amplifier input offset is a major contributor to the chain accuracy. The signal chain accuracy at 25 °C can be compensated during production at application level. The maximum input voltage drift over temperature enables the system designer to anticipate the effect of temperature variations.

The maximum input voltage drift over temperature is computed using [Equation 1](#).

Equation 1

$$\frac{\Delta V_{io}}{\Delta T} = \max \left| \frac{V_{io}(T) - V_{io}(25\text{ °C})}{T - 25\text{ °C}} \right|$$

Where T = -40 °C and 125 °C.

The datasheet maximum value is guaranteed by measurements on a representative sample size ensuring a C_{pk} (process capability index) greater than 2.

3.5 Long term input offset voltage drift

To evaluate product reliability, two types of stress acceleration are used:

- Voltage acceleration, by changing the applied voltage
- Temperature acceleration, by changing the die temperature (below the maximum junction temperature allowed by the technology) with the ambient temperature.

The voltage acceleration has been defined based on JEDEC results, and is defined using [Equation 2](#).

Equation 2

$$A_{FV} = e^{\beta \cdot (V_S - V_U)}$$

Where:

A_{FV} is the voltage acceleration factor

β is the voltage acceleration constant in 1/V, constant technology parameter ($\beta = 1$)

V_S is the stress voltage used for the accelerated test

V_U is the voltage used for the application

The temperature acceleration is driven by the Arrhenius model, and is defined in [Equation 3](#).

Equation 3

$$A_{FT} = e^{\frac{E_a}{k} \cdot \left(\frac{1}{T_U} - \frac{1}{T_S} \right)}$$

Where:

A_{FT} is the temperature acceleration factor

E_a is the activation energy of the technology based on the failure rate

k is the Boltzmann constant ($8.6173 \times 10^{-5} \text{ eV} \cdot \text{K}^{-1}$)

T_U is the temperature of the die when V_U is used (K)

T_S is the temperature of the die under temperature stress (K)

The final acceleration factor, A_F , is the multiplication of the voltage acceleration factor and the temperature acceleration factor ([Equation 4](#)).

Equation 4

$$A_F = A_{FT} \times A_{FV}$$

A_F is calculated using the temperature and voltage defined in the mission profile of the product. The A_F value can then be used in [Equation 5](#) to calculate the number of months of use equivalent to 1000 hours of reliable stress duration.

Equation 5

$$\text{Months} = A_F \times 1000 \text{ h} \times 12 \text{ months} / (24 \text{ h} \times 365.25 \text{ days})$$

To evaluate the op amp reliability, a follower stress condition is used where V_{CC} is defined as a function of the maximum operating voltage and the absolute maximum rating (as recommended by JEDEC rules).

The V_{io} drift (in μV) of the product after 1000 h of stress is tracked with parameters at different measurement conditions (see [Equation 6](#)).

Equation 6

$$V_{CC} = \max V_{op} \text{ with } V_{icm} = V_{CC} / 2$$

The long term drift parameter (ΔV_{io}), estimating the reliability performance of the product, is obtained using the ratio of the V_{io} (input offset voltage value) drift over the square root of the calculated number of months ([Equation 7](#)).

Equation 7

$$\Delta V_{io} = \frac{V_{io} \text{ drift}}{\sqrt{(\text{months})}}$$

Where V_{io} drift is the measured drift value in the specified test conditions after 1000 h stress duration.

3.6 ESD structure of TSB611

The TSB611 is protected against electrostatic discharge (ESD) with dedicated diodes (see [Figure 35](#)). These diodes must be considered at application level especially when signals applied on the input pins go beyond the power supply rails (V_{CC+} or V_{CC-}). Current through the diodes must be limited to a maximum of 10 mA as stated in [Table 1](#). A serial resistor or a Schottky diode can be used on the inputs to improve protection but the 10 mA limit of input current must be strictly observed.

Figure 35: ESD structure

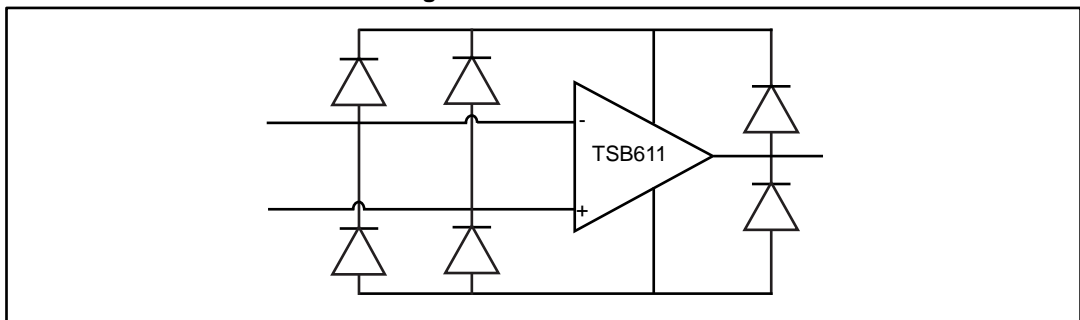

3.7 Initialization time

The TSB611 has a good power supply rejection ratio (PSRR), but as with all devices, it is recommended to use a 22 nF bypass capacitor as close as possible to the power supply pins. It prevents the noise present on the power supply impacting the signal conditioning. In addition, this bypass capacitor enhances the initialization time (see [Figure 36](#) and [Figure 37](#)).

Figure 36: Startup behavior without bypass capacitor

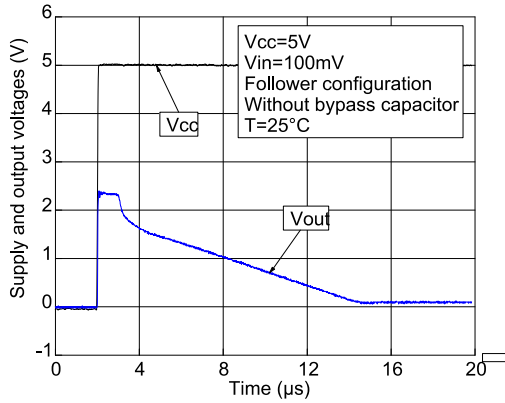
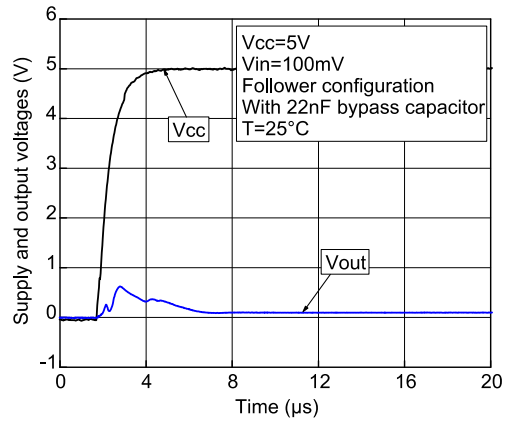

Figure 37: Startup behavior with a 22 nF bypass capacitor



4 Package information

In order to meet environmental requirements, ST offers these devices in different grades of ECOPACK® packages, depending on their level of environmental compliance. ECOPACK® specifications, grade definitions and product status are available at: www.st.com. ECOPACK® is an ST trademark.

4.1 SOT23-5 package information

Figure 38: SOT23-5 package outline

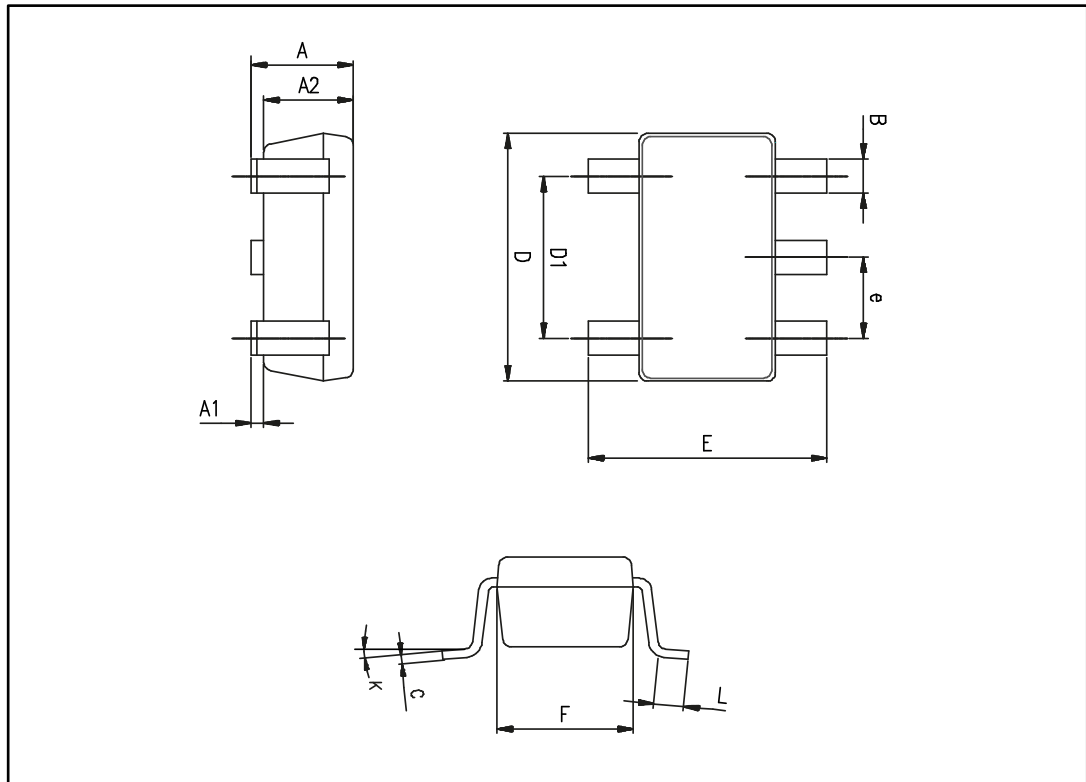

Table 6: SOT23-5 mechanical data

Ref.	Dimensions					
	Millimeters			Inches		
	Min.	Typ.	Max.	Min.	Typ.	Max.
A	0.90	1.20	1.45	0.035	0.047	0.057
A1			0.15			0.006
A2	0.90	1.05	1.30	0.035	0.041	0.051
B	0.35	0.40	0.50	0.014	0.016	0.020
C	0.09	0.15	0.20	0.004	0.006	0.008
D	2.80	2.90	3.00	0.110	0.114	0.118
D1		1.90			0.075	
e		0.95			0.037	
E	2.60	2.80	3.00	0.102	0.110	0.118
F	1.50	1.60	1.75	0.059	0.063	0.069
L	0.10	0.35	0.60	0.004	0.014	0.024
K	0 degrees		10 degrees	0 degrees		10 degrees

5 Ordering information

Table 7: Order codes

Order code	Temperature range	Package	Packing	Marking
TSB611ILT	-40 °C to 125 °C	SOT23-5	Tape and reel	K191
TSB611IYLT ⁽¹⁾				K194

Notes:

⁽¹⁾Qualified and characterized according to AEC Q100 and Q003 or equivalent, advanced screening according to AEC Q001 & Q002 or equivalent.

6 Revision history

Table 8: Document revision history

Date	Revision	Changes
17-Aug-2015	1	Initial release
15-May-2017	2	Updated automotive footnote in Table 7: "Order codes" .

IMPORTANT NOTICE – PLEASE READ CAREFULLY

STMicroelectronics NV and its subsidiaries ("ST") reserve the right to make changes, corrections, enhancements, modifications, and improvements to ST products and/or to this document at any time without notice. Purchasers should obtain the latest relevant information on ST products before placing orders. ST products are sold pursuant to ST's terms and conditions of sale in place at the time of order acknowledgement.

Purchasers are solely responsible for the choice, selection, and use of ST products and ST assumes no liability for application assistance or the design of Purchasers' products.

No license, express or implied, to any intellectual property right is granted by ST herein.

Resale of ST products with provisions different from the information set forth herein shall void any warranty granted by ST for such product.

ST and the ST logo are trademarks of ST. All other product or service names are the property of their respective owners.

Information in this document supersedes and replaces information previously supplied in any prior versions of this document.

© 2017 STMicroelectronics – All rights reserved

Компания «Life Electronics» занимается поставками электронных компонентов импортного и отечественного производства от производителей и со складов крупных дистрибьюторов Европы, Америки и Азии.

С конца 2013 года компания активно расширяет линейку поставок компонентов по направлению коаксиальный кабель, кварцевые генераторы и конденсаторы (керамические, пленочные, электролитические), за счёт заключения дистрибьюторских договоров

Мы предлагаем:

- Конкурентоспособные цены и скидки постоянным клиентам.
- Специальные условия для постоянных клиентов.
- Подбор аналогов.
- Поставку компонентов в любых объемах, удовлетворяющих вашим потребностям.
- Приемлемые сроки поставки, возможна ускоренная поставка.
- Доставку товара в любую точку России и стран СНГ.
- Комплексную поставку.
- Работу по проектам и поставку образцов.
- Формирование склада под заказчика.
- Сертификаты соответствия на поставляемую продукцию (по желанию клиента).
- Тестирование поставляемой продукции.
- Поставку компонентов, требующих военную и космическую приемку.
- Входной контроль качества.
- Наличие сертификата ISO.

В составе нашей компании организован Конструкторский отдел, призванный помогать разработчикам, и инженерам.

Конструкторский отдел помогает осуществить:

- Регистрацию проекта у производителя компонентов.
- Техническую поддержку проекта.
- Защиту от снятия компонента с производства.
- Оценку стоимости проекта по компонентам.
- Изготовление тестовой платы монтаж и пусконаладочные работы.



Тел: +7 (812) 336 43 04 (многоканальный)

Email: org@lifeelectronics.ru