



■ Features :

- DC/DC step-up converter
- Constant current output : 350mA to 1050mA
- Wide output LED string voltage up to 126VDC
- High efficiency up to 95%
- Built-in EMI filter ,comply with EN55015 without additional input filter and capacitors
- PWM + analog dimming and remote ON/OFF control [(Blank) type or W type]
- DALI dimming [(Blank)DA type or WDA type]
- Protections: Short circuit / Over voltage / Under voltage
- Cooling by free air convection
- Fully encapsulated
- 3 years warranty



LDH-45 □ -350 ○ □ =A or B; A: 9~18VDC input range, B: 18~32VDC input range
 ○ =(Blank) or W or (Blank)DA or WDA ;
 (Blank): PIN style, PWM+analog dimming
 W: Wire style, PWM+analog dimming
 (Blank)DA: PIN style, DALI dimming
 WDA: Wire style, DALI dimming

SPECIFICATION

MODEL		LDH-45A-350○	LDH-45A-500○	LDH-45A-700○	LDH-45A-1050○	LDH-45B-350○	LDH-45B-500○	LDH-45B-700○	LDH-45B-1050○	
OUTPUT	RATED CURRENT	350mA	500mA	700mA	1050mA	350mA	500mA	700mA	1050mA	
	CURRENT ACCURACY(Typ.)	±5% at 12VDC input				±5% at 24VDC input				
	VOLTAGE RANGE Note.2	Non-DALI	12~86VDC	12~86VDC	12~64VDC	12~43VDC	21~126VDC	21~86VDC	21~64VDC	21~43VDC
		DALI	24~86VDC	24~86VDC	24~64VDC	24~43VDC	36~126VDC	36~86VDC	36~64VDC	36~43VDC
	NO LOAD OUTPUT VOLTAGE(max.)	100V	100V	75V	50V	146V	100V	75V	50V	
	RATED POWER	30.1W	43W	44.8W	45.15W	44.1W	43W	44.8W	45.15W	
RIPPLE & NOISE (max.) Note.3	2.5Vp-p	2.5Vp-p	1.9Vp-p	1.9Vp-p	2.5Vp-p	1.7Vp-p	1.2Vp-p	1.2Vp-p		
INPUT	RATED VOLTAGE	12VDC				24VDC				
	VOLTAGE RANGE Note.2	9~18VDC				18~32VDC				
	EFFICIENCY (max.)	91%	90%	90%	91%	93%	94%	95%	95%	
	DC CURRENT (Typ.)	2.8A	4.1A	4.2A	4.2A	2.1A	2.1A	2A	2A	
PWM DIMMING & ON/OFF CONTROL	REMOTE ON/OFF	Leave open if not used Power ON with dimming: PWM signal >2~8VDC or open circuit, between PWM DIM and DIM- Power OFF : PWM signal <0.5VDC or short or PWM duty is equal to 0%, between PWM DIM and DIM-								
	PWM DIMMING FREQUENCY	1K~10KHz								
	QUIESCENT INPUT CURRENT IN SHUTDOWN MODE(Typ.)	7mA when PWM dimming OFF								
ANALOG DIMMING & ON/OFF CONTROL	REMOTE ON/OFF	Leave open if not used Power on with dimming: DC input >0.25~8VDC or open circuit, between Analog DIM and DIM- Power off : DC input <0.2VDC or short, between Analog DIM and DIM-								
	DIM INPUT VOLTAGE RANGE	0.25~1.3VDC								
	MAX OPERATION VOLTAGE	8V; The output current remains constant when voltage changes from 1.3V to 8V								
	QUIESCENT INPUT CURRENT IN SHUTDOWN MODE(Typ.)	7mA when Analog dimming OFF								
PROTECTION	SHORT CIRCUIT	Protection type : Power OFF and fuse open								
	OVER VOLTAGE (max.)	100V	100V	75V	50V	146V	100V	75V	50V	
ENVIRONMENT	WORKING TEMP.	-40 ~ +70°C (Refer to "Derating Curve")								
	WORKING HUMIDITY	20 ~ 90% RH non-condensing								
	STORAGE TEMP., HUMIDITY	-40 ~ +85°C, 10 ~ 95% RH								
	TEMP. COEFFICIENT	±0.03%/°C (0 ~ 50°C)								
	VIBRATION	10 ~ 500Hz, 2G 10min./1cycle, period for 60min. each along X, Y, Z axes								
SAFETY & EMC	SAFETY STANDARDS	EAC TP TC 004 approved								
	EMC EMISSION	Compliance to EN55015;EAC TP TC 020								
	EMC IMMUNITY	Compliance to EN61547,EN61000-4-2,3,4,6,8; light industry level, criteria A;EAC TP TC 020								
OTHERS	MTBF	1179.3Khrs min. MIL-HDBK-217F (25□)								
	DIMENSION	75*53*22.7mm (L*W*H)								
	PACKING	138g;100pcs/14.8Kg/0.83CUFT[(Blank) type or (Blank) DA type],1.04CUFT(W type or WDA type)								
NOTE	1. All parameters are specified at normal input(12VDC,24VDC), rated load, 25°C 70% RH ambient. 2. (Blank) type and W type output voltage must step up by 3 Volts from input DC voltage; (Blank)DA type and WDA type output voltage must step up by 12 Volts from input DC voltage. 3. Ripple & noise are measured at 20MHz of bandwidth by using a 12" twisted pair-wire terminated with a 0.1uf parallel capacitor.									

Mechanical Specification

LDH (PIN Style):

Unit: mm [inch]

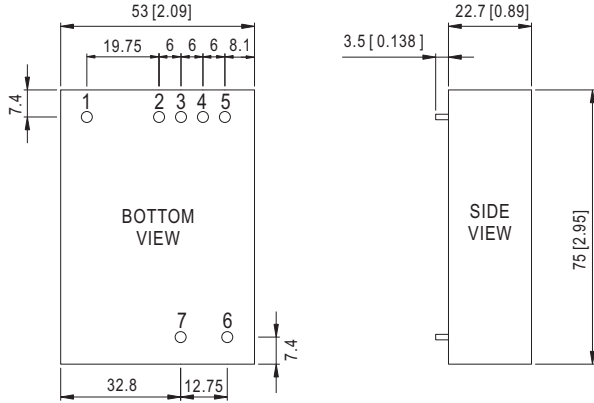

NOTE: PIN size tolerance 1.0 ϕ \pm 0.05mm

Pin Configuration

PIN No.	Output	Description
1	Vin+	DC Supply
2	Vin-	Don't connect to Vout-
3	DIM-	○=(Blank) type: GND of DIM signal Don't connect to Vout- or Vin-
	DA-	○=(Blank)DA type: DALI- signal
4	Analog DIM	○=(Blank) type: ON/OFF and analog dimming (leave open if not used)
	DA+	○=(Blank)DA type: DALI+ signal
5	PWM DIM	ON/OFF and PWM dimming (leave open if not used) [(Blank)DA type: no such PIN]
6	Vout-	LED - connection
7	Vout+	LED + connection

LDH (Wire Style):

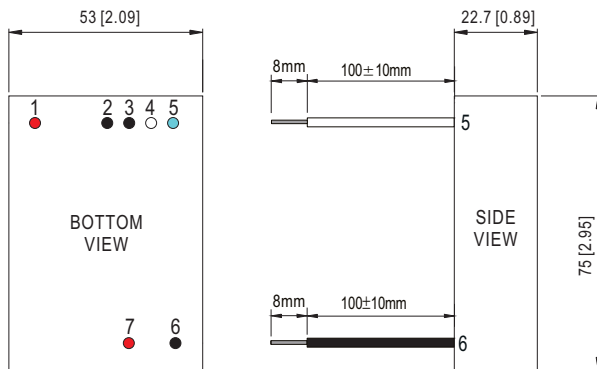

PIN No.	Output	Description
1	Vin+(red)	DC Supply
2	Vin-(black)	Don't connect to Vout-
3	DIM-(black)	○=W type: GND of DIM signal Don't connect to Vout- or Vin-
	DA-(white)	○=WDA type: DALI- signal
4	Analog DIM (white)	○=W type: ON/OFF and analog dimming (leave open if not used)
	DA+(blue)	○=WDA type: DALI+ signal
5	PWM DIM (blue)	ON/OFF and PWM dimming (leave open if not used) [WDA type: no such PIN]
6	Vout-(black)	LED - connection
7	Vout+(red)	LED + connection

Derating Curve

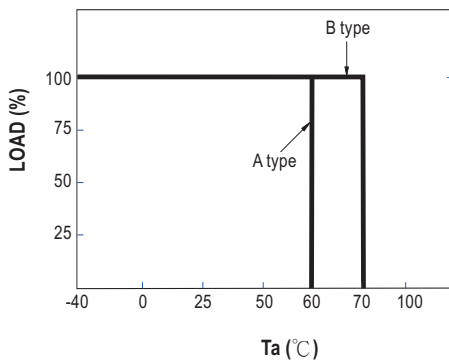

Static Characteristics

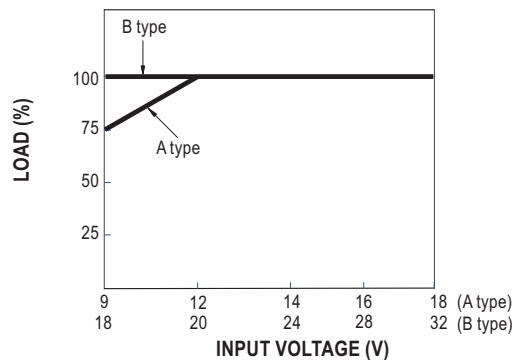

■ Standard Application

※ Operation without dimming:

I_O operates at rated current without dimming function when the pins of analog DIM and PWM DIM keep open

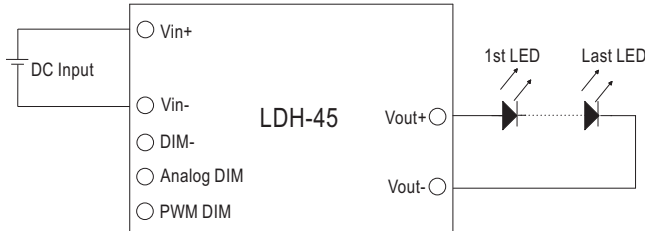

※ PWM Dimming Control (non DA type):

I_O adjustment by PWM Signal

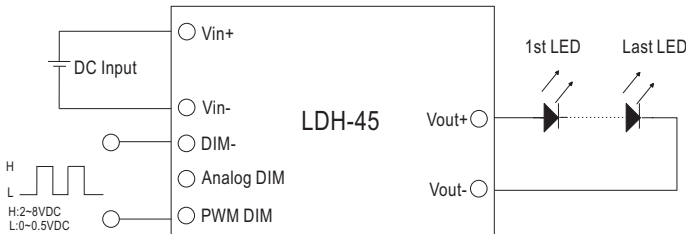

During PWM dimming operation, I_O will change with the PWM duty (PWM Signal: 1K~10KHz)

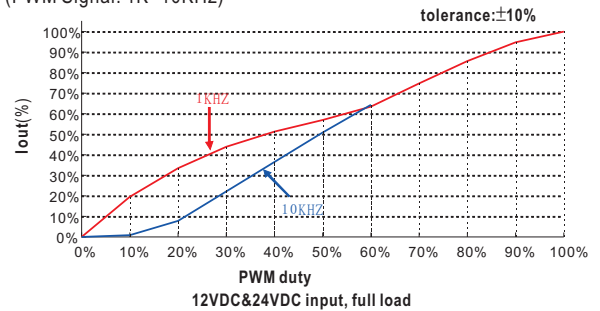

Note: DALI dimming curve refer to 10KHz curve

※ Analog Dimming Control (non DA type):

I_O adjustment by DC voltage



During analog dimming operation, I_O will change with DC input voltage

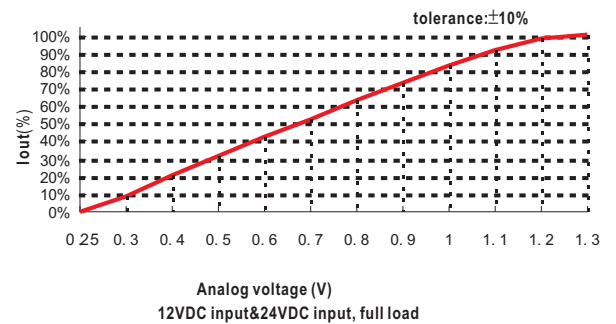

※ DALI Dimming Control (DA type only):

I_O adjustment by DALI signal



- DALI protocol including 16 groups and 64 addresses.
- Min. dimming level is about 8% of output.

■ Efficiency VS Output Voltage(Number of LEDs)

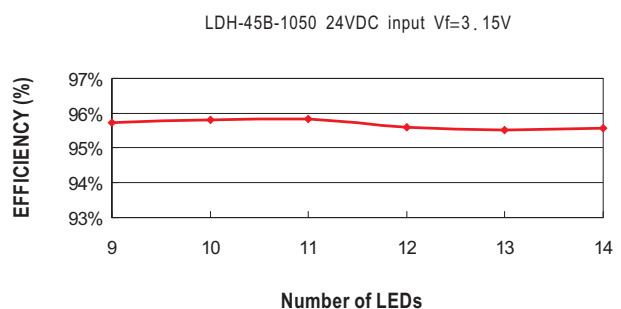
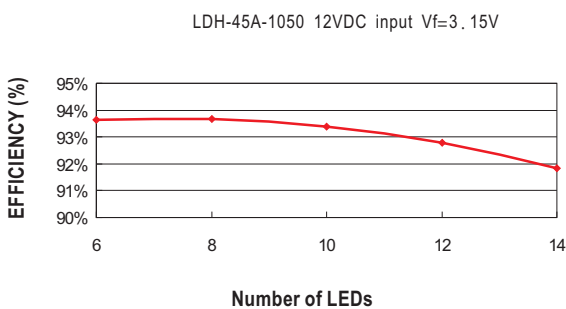
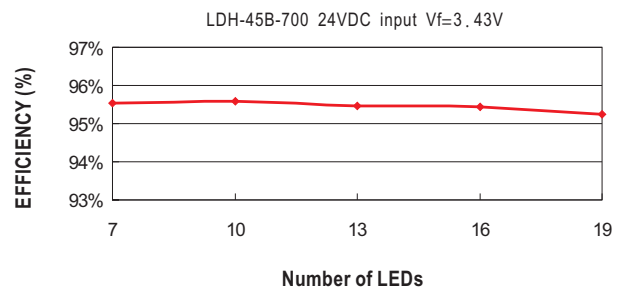
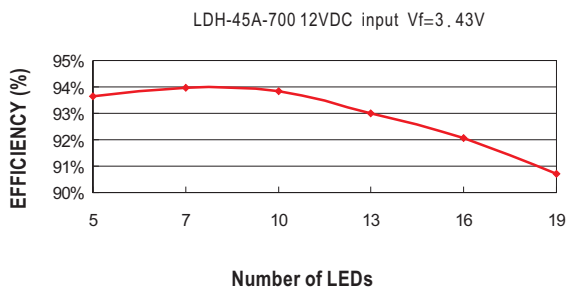
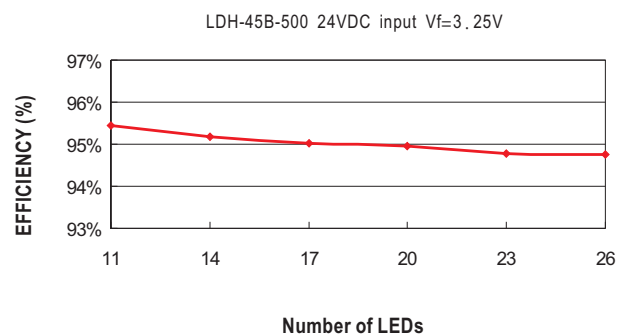
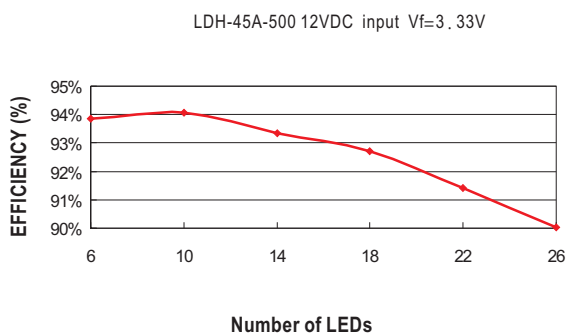
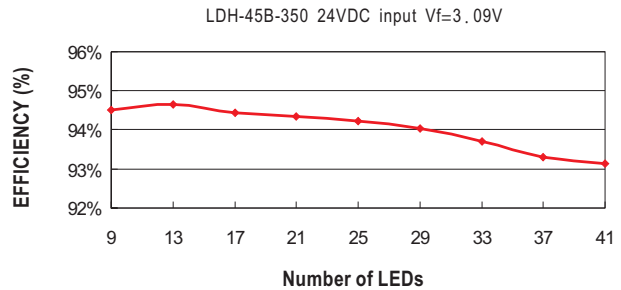
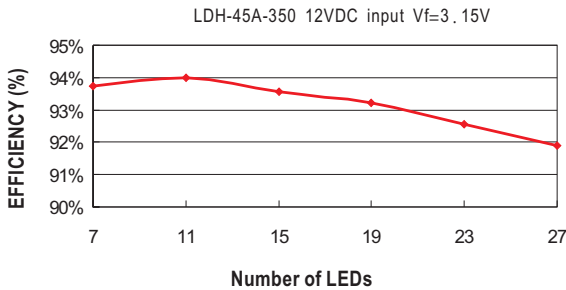

Application Notes:

1. The positive and negative input terminals must be connected correctly and negative voltage can not be input to avoid damage to the power supply.
2. Due to the large input current, please pay attention to the voltage drop of the wiring, to ensure the power supply to work properly.
3. At dim off, LDH output voltage will drop to the same level as input voltage. To get luminaires complete dark, please make luminaires are light off when they are driving by the input voltage.

Компания «Life Electronics» занимается поставками электронных компонентов импортного и отечественного производства от производителей и со складов крупных дистрибьюторов Европы, Америки и Азии.

С конца 2013 года компания активно расширяет линейку поставок компонентов по направлению коаксиальный кабель, кварцевые генераторы и конденсаторы (керамические, пленочные, электролитические), за счёт заключения дистрибьюторских договоров

Мы предлагаем:

- Конкуренеспособные цены и скидки постоянным клиентам.
- Специальные условия для постоянных клиентов.
- Подбор аналогов.
- Поставку компонентов в любых объемах, удовлетворяющих вашим потребностям.
- Приемлемые сроки поставки, возможна ускоренная поставка.
- Доставку товара в любую точку России и стран СНГ.
- Комплексную поставку.
- Работу по проектам и поставку образцов.
- Формирование склада под заказчика.
- Сертификаты соответствия на поставляемую продукцию (по желанию клиента).
- Тестирование поставляемой продукции.
- Поставку компонентов, требующих военную и космическую приемку.
- Входной контроль качества.
- Наличие сертификата ISO.

В составе нашей компании организован Конструкторский отдел, призванный помогать разработчикам, и инженерам.

Конструкторский отдел помогает осуществить:

- Регистрацию проекта у производителя компонентов.
- Техническую поддержку проекта.
- Защиту от снятия компонента с производства.
- Оценку стоимости проекта по компонентам.
- Изготовление тестовой платы монтаж и пусконаладочные работы.



Тел: +7 (812) 336 43 04 (многоканальный)

Email: org@lifeelectronics.ru