

**SIL type SSR with
9mm thickness
controls up to 3 A**

AQ8 RELAYS



RoHS compliant

FEATURES

1. Slim with 9 mm .354 inch thickness
The thin type (45 mm long × 24 mm high × 9 mm wide) (1.772×.945×.354 inch) permits high density mounting.

2. Excellent in noise resistance
Since the input and output are insulated by the phototriac coupler, the noise on the output side is not fed back to the input side.

3. Snubber circuit integrated
The snubber circuit is integrated to prevent malfunction caused by the rapid rise of the voltage on the output side, such as inductive load and noise.

4. Zero-cross and random types are available.
The zero-cross type generates minimal noise by suppressing occurrence of radio frequency interference (RFI) and electro-magnetic interference (EMI).

The random type features a short operation time which permits phase control.

5. High dielectric strength: 3,000 Vrms (between input and output)

6. Two kinds of terminals distance are available. (5.08 mm and 7.62 mm) (.200 and .300 inch)

7. High reliability, long life and maintenance-free

TYPICAL APPLICATIONS

1. Most suitable as drivers for small size AC motors, solenoids, solenoid valves and so on.

2. Copying equipment

3. Air conditioners

4. Industrial equipment such as NC machines, sequencers, robots, etc.

ORDERING INFORMATION

AQ - -

Load current

2 A

3 A

Load voltage

2: 75 to 250 Vrms

Input terminal distance

C1: 5.08 mm .200 inch

C2: 7.62 mm .300 inch

Type

ZT: Zero-cross type

T: Random type

Control voltage

5V DC: 4 to 6 V DC

12V DC: 9.6 to 14.4 V DC

24V DC: 21.6 to 26.4 V DC

TYPES

| Types | Load current | Load voltage | Control voltage | Input terminals distance (5.08 mm .200 inch type) | Input terminals distance (7.62 mm .300 inch type) |
|-----------------|--------------|----------------|-------------------|--|--|
| | | | | Part No. | Part No. |
| Zero-cross type | 2 A | 75 to 250 Vrms | 4 to 6 V DC | AQ2A2-C1-ZT5VDC | AQ2A2-C2-ZT5VDC |
| | | | 9.6 to 14.4 V DC | AQ2A2-C1-ZT12VDC | AQ2A2-C2-ZT12VDC |
| | | | 21.6 to 26.4 V DC | AQ2A2-C1-ZT24VDC | AQ2A2-C2-ZT24VDC |
| | 3 A | 75 to 250 Vrms | 4 to 6 V DC | AQ3A2-C1-ZT5VDC | AQ3A2-C2-ZT5VDC |
| | | | 9.6 to 14.4 V DC | AQ3A2-C1-ZT12VDC | AQ3A2-C2-ZT12VDC |
| | | | 21.6 to 26.4 V DC | AQ3A2-C1-ZT24VDC | AQ3A2-C2-ZT24VDC |
| Random type | 2 A | 75 to 250 Vrms | 4 to 6 V DC | AQ2A2-C1-T5VDC | AQ2A2-C2-T5VDC |
| | | | 9.6 to 14.4 V DC | AQ2A2-C1-T12VDC | AQ2A2-C2-T12VDC |
| | | | 21.6 to 26.4 V DC | AQ2A2-C1-T24VDC | AQ2A2-C2-T24VDC |
| | 3 A | 75 to 250 Vrms | 4 to 6 V DC | AQ3A2-C1-T5VDC | AQ3A2-C2-T5VDC |
| | | | 9.6 to 14.4 V DC | AQ3A2-C1-T12VDC | AQ3A2-C2-T12VDC |
| | | | 21.6 to 26.4 V DC | AQ3A2-C1-T24VDC | AQ3A2-C2-T24VDC |

Standard packing: Carton 20 pcs., Case 200 pcs.

RATING

1. Rating (Ambient temperature: 20°C, 68°F; Voltage ripple on the input side: 1% or less)

1) Zero-cross type

• 2 A type

| Item | Part No. | AQ2A2-C1-ZT5VDC AQ2A2-C2-ZT5VDC | AQ2A2-C1-ZT12VDC AQ2A2-C2-ZT12VDC | AQ2A2-C1-ZT24VDC AQ2A2-C2-ZT24VDC | Remarks |
|-----------------|----------------------------------|------------------------------------|--------------------------------------|--------------------------------------|--|
| Input side | Rated voltage | 5 V DC | 12 V DC | 24 V DC | *1 |
| | Control voltage | 4 to 6 V DC | 9.6 to 14.4 V DC | 21.6 to 26.4 V DC | |
| | Input impedance | Approx. 0.18 kΩ | Approx. 0.55 kΩ | Approx. 1.4 kΩ | |
| | Drop-out voltage | Min. 0.5 V | Min. 1.2 V | Min. 2.4 V | |
| Load side | Max. load current | 2 A*2 | | | At ambient temperature of 30°C or less |
| | Load voltage | 75 to 250 Vrms | | | |
| | Frequency | 45 to 65 Hz | | | |
| | Repetitive peak OFF voltage | 600 V | | | |
| | Non-repetitive surge current | 30 A*3 | | | In one cycle at 60 Hz |
| | Max. "OFF-state" leakage current | 5 mA (200 Vrms applied) | | | at 60 Hz |
| | Max. "ON-state" voltage drop | 1.6 V | | | at max. carrying current |
| | Min. load current | 50 mA*4 | | | |
| OFF state dV/dt | 50 V/μs | | | At ambient temperature of 80°C | |

• 3 A type

| Item | Part No. | AQ3A2-C1-ZT5VDC AQ3A2-C2-ZT5VDC | AQ3A2-C1-ZT12VDC AQ3A2-C2-ZT12VDC | AQ3A2-C1-ZT24VDC AQ3A2-C2-ZT24VDC | Remarks |
|-----------------|----------------------------------|------------------------------------|--------------------------------------|--------------------------------------|--|
| Input side | Rated voltage | 5 V DC | 12 V DC | 24 V DC | *1 |
| | Control voltage | 4 to 6V DC | 9.6 to 14.4V DC | 21.6 to 26.4V DC | |
| | Input impedance | Approx. 0.18 kΩ | Approx. 0.55 kΩ | Approx. 1.4 kΩ | |
| | Drop-out voltage | Min. 0.5 V | Min. 1.2 V | Min. 2.4 V | |
| Load side | Max. load current | 3 A*2 | | | At ambient temperature of 30°C or less |
| | Load voltage | 75 to 250 Vrms | | | |
| | Frequency | 45 to 65 Hz | | | |
| | Repetitive peak OFF voltage | 600 V | | | |
| | Non-repetitive surge current | 80 A*3 | | | In one cycle at 60 Hz |
| | Max. "OFF-state" leakage current | 5 mA (200 Vrms applied) | | | at 60 Hz |
| | Max. "ON-state" voltage drop | 1.6 V | | | at max. carrying current |
| | Min. load current | 50 mA*4 | | | |
| OFF state dV/dt | 50 V/μs | | | At ambient temperature of 80°C | |

Notes: *1. Refer to REFERENCE DATA "3. Characteristics of input current vs. input voltage".

*2. Refer to REFERENCE DATA "1. Characteristics of load current vs. ambient temperature".

*3. Refer to REFERENCE DATA "2. Characteristics of non-repetitive surge current vs. carrying time".

*4. When the load current is less than the rated minimum load current, please refer to "Cautions for Use of Solid State Relays".

2) Random type

• 2 A type

| Item | Part No. | AQ2A2-C1-T5VDC AQ2A2-C2-T5VDC | AQ2A2-C1-T12VDC AQ2A2-C2-T12VDC | AQ2A2-C1-T24VDC AQ2A2-C2-T24VDC | Remarks |
|-----------------|----------------------------------|----------------------------------|------------------------------------|------------------------------------|--|
| Input side | Rated voltage | 5 V DC | 12 V DC | 24 V DC | *1 |
| | Control voltage | 4 to 6 V DC | 9.6 to 14.4 V DC | 21.6 to 26.4 V DC | |
| | Input impedance | Approx. 0.3 kΩ | Approx. 0.8 kΩ | Approx. 1.8 kΩ | |
| | Drop-out voltage | Min. 0.5 V | Min. 1.2 V | Min. 2.4 V | |
| Load side | Max. load current | 2 A*2 | | | At ambient temperature of 30°C or less |
| | Load voltage | 75 to 250 Vrms | | | |
| | Frequency | 45 to 65 Hz | | | |
| | Repetitive peak OFF voltage | 600 V | | | |
| | Non-repetitive surge current | 30 A*3 | | | In one cycle at 60 Hz |
| | Max. "OFF-state" leakage current | 5 mA (200 Vrms applied) | | | at 60 Hz |
| | Max. "ON-state" voltage drop | 1.6 V | | | at max. carrying current |
| | Min. load current | 50 mA*4 | | | |
| OFF state dV/dt | 50 V/μs | | | At ambient temperature of 80°C | |

• 3 A type

| Item | Part No. | AQ3A2-C1-T5VDC AQ3A2-C2-T5VDC | AQ3A2-C1-T12VDC AQ3A2-C2-T12VDC | AQ3A2-C1-T24VDC AQ3A2-C2-T24VDC | Remarks |
|-----------------|----------------------------------|----------------------------------|------------------------------------|------------------------------------|--|
| Input side | Rated voltage | 5 V DC | 12 V DC | 24 V DC | *1 |
| | Control voltage | 4 to 6 V DC | 9.6 to 14.4 V DC | 21.6 to 26.4 V DC | |
| | Input impedance | Approx. 0.3 kΩ | Approx. 0.8 kΩ | Approx. 1.8 kΩ | |
| | Drop-out voltage | Min. 0.5 V | Min. 1.2 V | Min. 2.4 V | |
| Load side | Max. load current | 3 A*2 | | | At ambient temperature of 30°C or less |
| | Load voltage | 75 to 250 Vrms | | | |
| | Frequency | 45 to 65 Hz | | | |
| | Repetitive peak OFF voltage | 600 V | | | |
| | Non-repetitive surge current | 80 A*3 | | | In one cycle at 60 Hz |
| | Max. "OFF-state" leakage current | 5 mA (200 Vrms applied) | | | at 60 Hz |
| | Max. "ON-state" voltage drop | 1.6 V | | | at max. carrying current |
| | Min. load current | 50 mA*4 | | | |
| OFF state dV/dt | 50 V/μs | | | At ambient temperature of 80°C | |

Notes: *1. Refer to REFERENCE DATA "3. Characteristics of input current vs. input voltage".

*2. Refer to REFERENCE DATA "1. Characteristics of load current vs. ambient temperature".

*3. Refer to REFERENCE DATA "2. characteristics of non-repetitive surge current vs. carrying time".

*4. When the load current is less than the rated minimum load current, please refer to "Cautions for Use of Solid State Relays".

2. Characteristics (Ambient temperature: 20°C 68°F; Input voltage ripple: 1% or less)

| Item | Type | Zero-cross type | Random type | Remarks |
|-----------------------------|-------------|--|-------------------------------------|------------------------------------|
| Operate time, max. | | 1/2 cycle of voltage sine wave +1 ms | 1 ms | |
| Release time, max. | | 1/2 cycle of voltage sine wave +1 ms | | |
| Insulation resistance, min. | | 10 ⁹ Ω between input and output | | at 500 V DC |
| Breakdown voltage | | 3,000 Vrms between input and output | | For 1 minute |
| Vibration resistance | Destructive | 10 to 55 Hz at double amplitude of 3 mm | | 1 hour for X, Y, Z axis |
| | Functional | 10 to 55 Hz at double amplitude of 3 mm | | 10 min. for X, Y, Z axis |
| Shock resistance | Destructive | Min. 980 m/s ² {100 G} | | 5 times each for X, Y, Z axis |
| | Functional | Min. 980 m/s ² {100 G} | | 4 times each for X, Y, Z axis |
| Ambient temperature | | -30 to +80°C -22 to +176°F | | Non-condensing at low temperatures |
| Storage temperature | | -30 to +100°C -22 to +212°F | | Non-condensing at low temperatures |
| Operational method | | Zero-cross (Turn ON and Turn OFF) | Random turn ON, zero-cross turn OFF | |

REFERENCE DATA

1. Characteristics of load current vs. ambient temperature
 Use load current within range specified in the figure below.

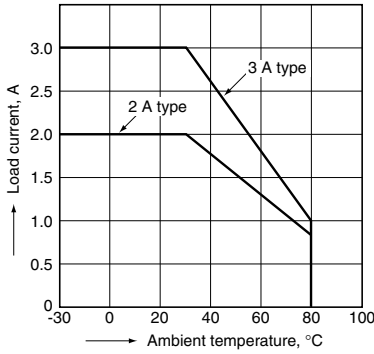

2.-(1) Characteristics of non-repetitive surge current vs. carrying time*
 (2 A type)

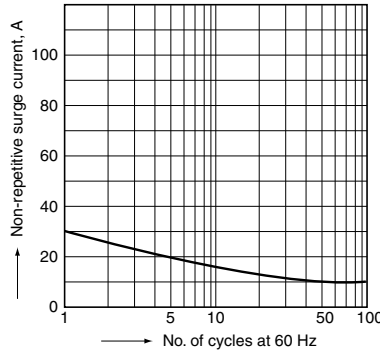

2.-(2) Characteristics of non-repetitive surge current vs. carrying time*
 (3 A type)

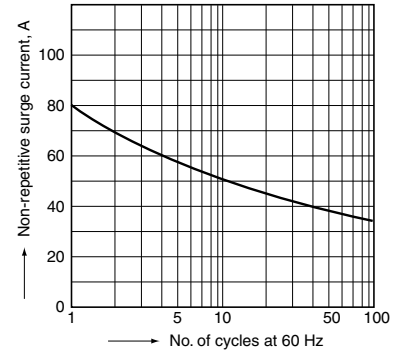

Note: * The above chart shows non-repetitive maximum rating. If a surge current is applied repeatedly, please keep it approximately 50% or less than the values shown in the above graph.

3. Characteristics of input current vs. input voltage
 ---zero-cross type
 ---Random type

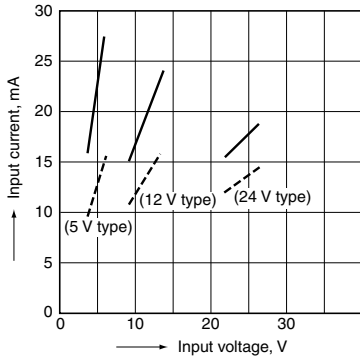

4.-(1) Characteristics of load current vs. ambient temperature for adjacent mounting
 (2 A type)
 Conditions: Natural cooling

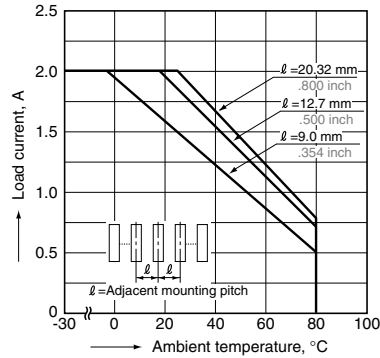

4.-(2) Characteristics of load current vs. ambient temperature for adjacent mounting
 (3 A type)
 Conditions: Natural cooling

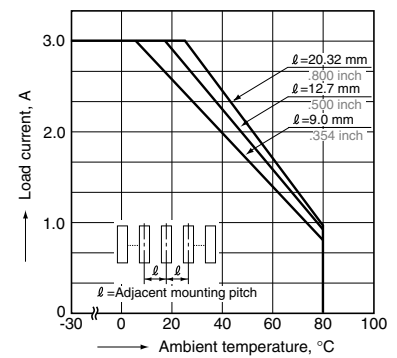

DIMENSIONS (mm inch)

The CAD data of the products with a **CAD** mark can be downloaded from: <https://industrial.panasonic.com/ac/e/>

(Common for zero-cross and random types)

1. Input terminals distance 5.08 mm .200 inch

1) 2 A type

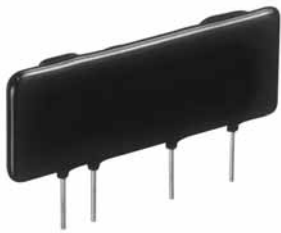

External dimensions

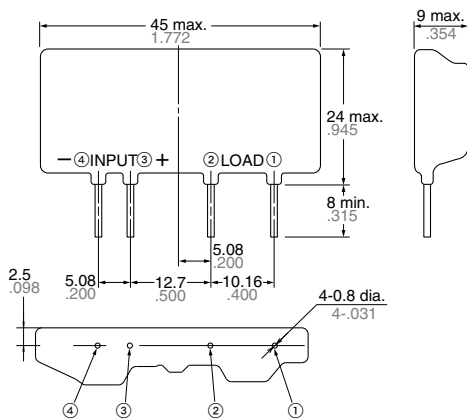

General tolerance: $\pm 0.5 \pm .020$

Mounting hole location (Bottom view)

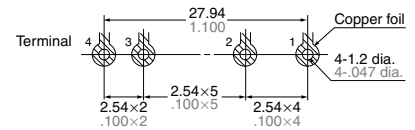

Tolerance: $\pm 0.1 \pm .004$

2) 3 A type

CAD



External dimensions



General tolerance: $\pm 0.5 \pm .020$

Mounting hole location (Bottom view)



Tolerance: $\pm 0.1 \pm .004$

2. Input terminals distance 7.62 mm .300 inch

1) 2 A type

CAD



External dimensions



General tolerance: $\pm 0.5 \pm .020$

Mounting hole location (Bottom view)



Tolerance: $\pm 0.1 \pm .004$

2) 3 A type

CAD



External dimensions



General tolerance: $\pm 0.5 \pm .020$

Mounting hole location (Bottom view)



Tolerance: $\pm 0.1 \pm .004$

SCHEMATIC AND WIRING DIAGRAMS

| Schematic | Output configuration | Load | Wiring diagram |
|-----------|----------------------|------|----------------|
| | 1 Form A | AC | |
| | 1 Form A | AC | |

NOTES

1. When used for the load less than rated

In case of the load current less than rated, malfunction may result from the residual voltage across the both ends of the load even if the solid state relay is turned off. Use a dummy resistor as a countermeasure. The total of the current through the resistor and the load current must exceed the min. rated load current.

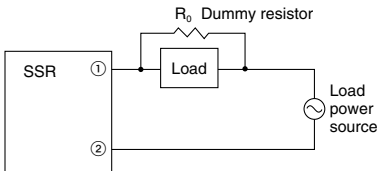

In case the dummy resistor is not used, keep in mind that the residual voltage becomes as follows:

Example:

For the inductive load by the 20 mA load current and the 200 Vrms load voltage, the load impedance becomes 10 kΩ and $V_e/V = 14\%$ is estimated from the right above graph. Accordingly, the 28 V voltage remains across the both ends of the load when the solid state relay is turned off.

• Characteristics of residual voltage vs. load impedance

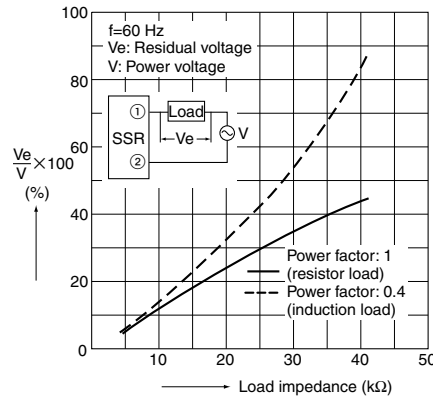

2. when the terminal is bent

Care shall be taken neither to apply mechanical stresses to the mold area of the solid state relay nor to bend the terminal 45 degrees or more.

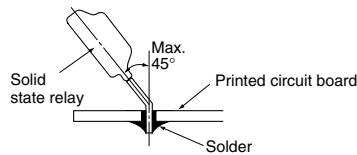

Recommended Temperature Controllers



<KT4H Temperature Controller>

Our temperature controller is recommended for use with our Solid State Relays.

Features

- Space saving requiring only a depth of 65 mm
- Data collection possible through a PLC using RS485 communication
- Tool port is standard for easy data setting
- Inverted LCD + backlight for good legibility with large characters
- Excellent operability and rich optional control functions

Substitute part numbers

| Power supply | Control output | Part No. |
|-----------------|----------------------------|-------------|
| 100 to 240 Vrms | Non-contact voltage output | AKT4H112100 |

* For detailed product information about temperature controllers, please refer to our website:
https://industrial.panasonic.com/ac/e/fasys/component/temperature_controller/

Please contact

Panasonic Corporation

Electromechanical Control Business Division

■ 1006, Oaza Kadoma, Kadoma-shi, Osaka 571-8506, Japan
industrial.panasonic.com/ac/e/

Panasonic[®]

©Panasonic Corporation 2018

Mouser Electronics

Authorized Distributor

Click to View Pricing, Inventory, Delivery & Lifecycle Information:

Panasonic:

[AQ2A1-C1-T5VDC](#) [AQ2A1-C1-ZT5VDC](#) [AQ2A1-C1-T24VDC](#) [AQ2A1-C1-T12VDC](#) [AQ3A1-C1-T5VDC](#) [AQ2A1-C1-ZT24VDC](#) [AQ3A1-C1-ZT24VDC](#) [AQ3A1-C1-ZT5VDC](#) [AQ2A1-C1-ZT12VDC](#) [AQ3A1-C2-ZT5VDC](#) [AQ2A1-C2-ZT12VDC](#) [AQ2A1-C2-ZT24VDC](#) [AQ2A1-C2-T12VDC](#) [AQ2A1-C2-T24VDC](#) [AQ2A1-C2-T5VDC](#) [AQ2A1-C2-ZT5VDC](#) [AQ3A1-C1-T24VDC](#)

Компания «Life Electronics» занимается поставками электронных компонентов импортного и отечественного производства от производителей и со складов крупных дистрибьюторов Европы, Америки и Азии.

С конца 2013 года компания активно расширяет линейку поставок компонентов по направлению коаксиальный кабель, кварцевые генераторы и конденсаторы (керамические, пленочные, электролитические), за счёт заключения дистрибьюторских договоров

Мы предлагаем:

- Конкурентоспособные цены и скидки постоянным клиентам.
- Специальные условия для постоянных клиентов.
- Подбор аналогов.
- Поставку компонентов в любых объемах, удовлетворяющих вашим потребностям.
- Приемлемые сроки поставки, возможна ускоренная поставка.
- Доставку товара в любую точку России и стран СНГ.
- Комплексную поставку.
- Работу по проектам и поставку образцов.
- Формирование склада под заказчика.
- Сертификаты соответствия на поставляемую продукцию (по желанию клиента).
- Тестирование поставляемой продукции.
- Поставку компонентов, требующих военную и космическую приемку.
- Входной контроль качества.
- Наличие сертификата ISO.

В составе нашей компании организован Конструкторский отдел, призванный помогать разработчикам, и инженерам.

Конструкторский отдел помогает осуществить:

- Регистрацию проекта у производителя компонентов.
- Техническую поддержку проекта.
- Защиту от снятия компонента с производства.
- Оценку стоимости проекта по компонентам.
- Изготовление тестовой платы монтаж и пусконаладочные работы.



Тел: +7 (812) 336 43 04 (многоканальный)

Email: org@lifeelectronics.ru