

**Feature -**

- small size
- bi-color LED illuminated available
- long electrical life cycles
- right angle and vertical PCB terminal

**Applications -**

- consumer products
- computer products
- instrumentation
- communication equipments

**SPECIFICATIONS**

SWITCH SPECIFICATIONS	
POLE - POSITION	1P1T, Right Angle Push on Type, with or w/o LED are Available
CONTACT RATING	12 V DC, 50 mA
CONTACT RESISTANCE	100 mΩ MAX. 1.5 V DC ; 100 mA, by Method of Voltage DROP
INSULATION RESISTANCE	100 MΩ MIN. 500 V DC
DIELECTRIC STRENGTH	Breakdown Is not Allowable ; 500 V AC for 1 Minute
OPERATING FORCE	160 ± 50 gf
OPERATING LIFE	500,000 cycles
OPERATING TEMPERATURE RANGE	-20°C ~ 70°C
TOTAL TRAVEL	0.2 ± 0.1 mm

LED SPECIFICATIONS							
	ATTENTION LEDs are Electrostatic Sensitive devices	Unit	Value / LED Color				
			Blue	Green	Red	White	Yellow
FORWARD CURRENT	If	mA	10	20	20	2	20
REVERSE VOLTAGE	Vr	V	5,0	5,0	5,0	5,0	5,0
REVERSE CURRENT	Ir	μA	10	10	10	10	10
FORWARD VOLTAGE	Vf	V	@ 10mA 3,0-4,0	2,1-2,5	2,0-2,5	@ 2mA 2,8-4,0	2,0-2,5
LUMINOUS INTENSITY	Iv	mcd	@ 10mA 200	800	1800	@ 2mA 12	1800

Physical and electrical information of LED will be provided upon customer's request on switches.

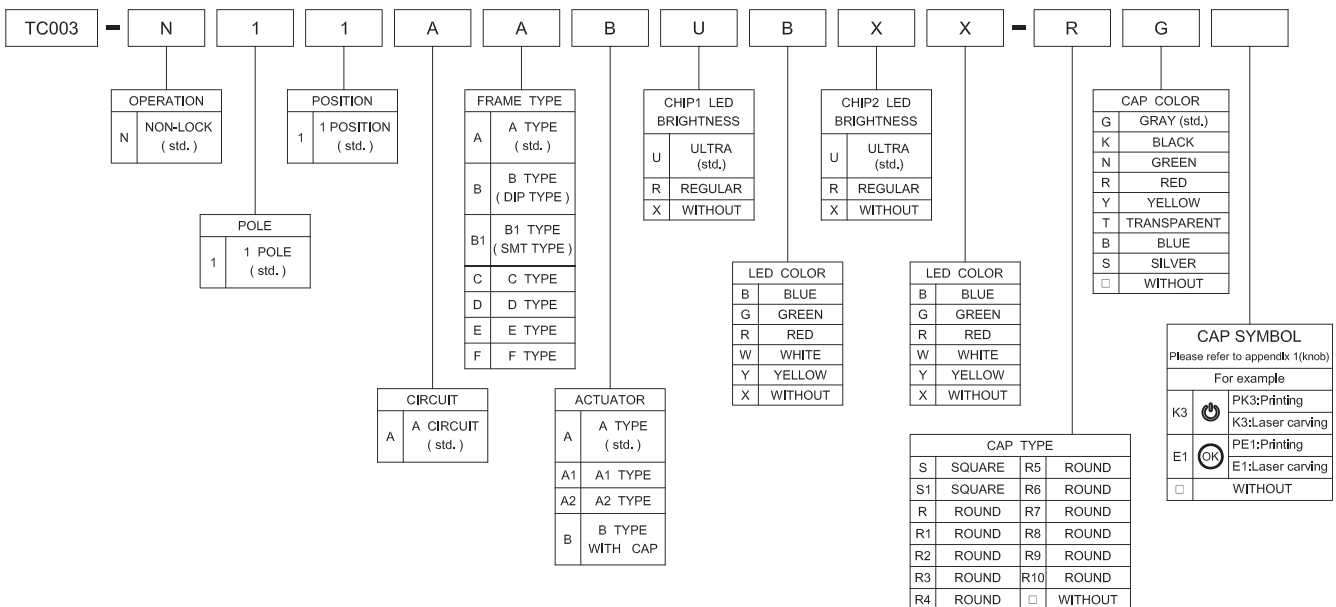
**HOW TO ORDER**

▶ **FRAME TYPE OPTION**

TYPE : A

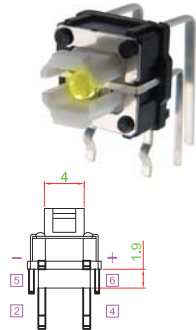
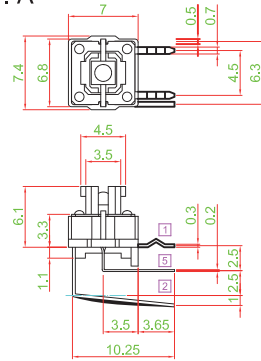

TYPE : B

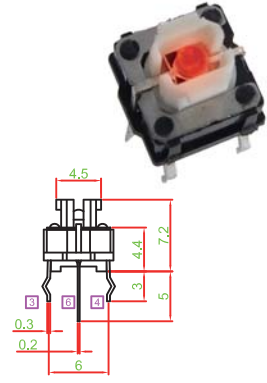
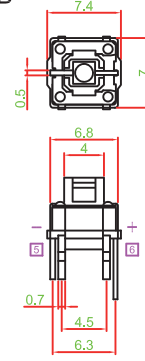

TYPE : C

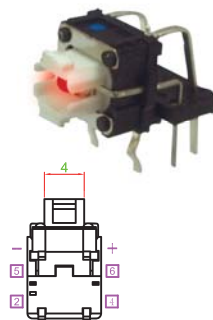
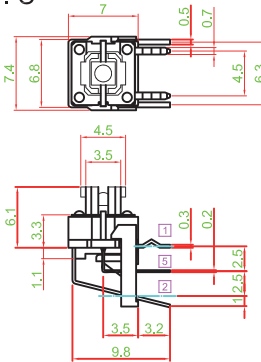

TYPE : B1

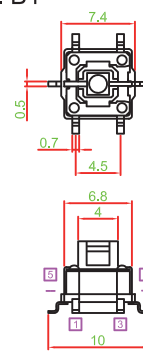

TYPE : D

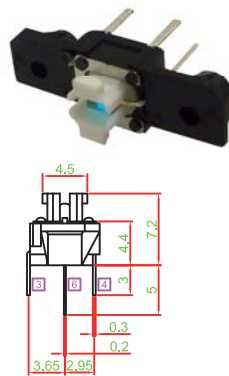
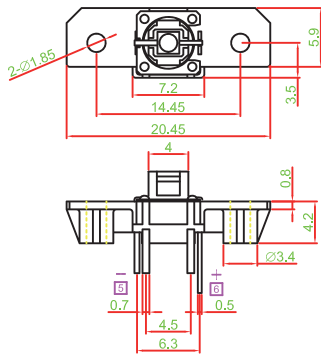

TYPE : E

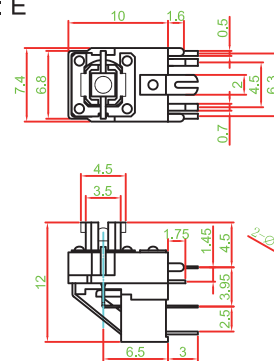

TYPE : F

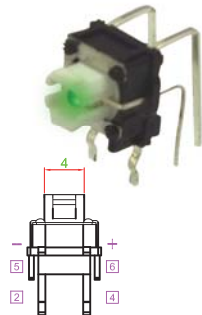
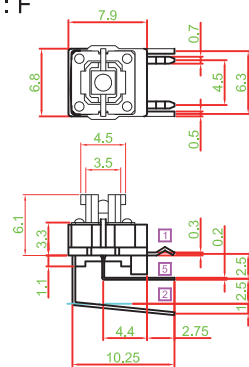

▶ **ACTUATOR TYPE OPTION**

TYPE : A

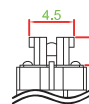

TYPE : A1

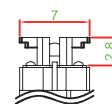

TYPE : A2

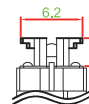

TYPE : B



**▶ KNOB TYPE OPTION**

<b>S TYPE</b> 	<b>S1 TYPE</b> 	<b>R TYPE</b> 
<b>R1 TYPE</b> 	<b>R2 TYPE</b> 	<b>R3 TYPE</b> 
<b>R4 TYPE</b> 	<b>R5 TYPE</b> 	<b>R6 TYPE</b> 
<b>R7 TYPE</b> 	<b>R8 TYPE (ODM)</b> 	<b>R9 TYPE (ODM)</b> 

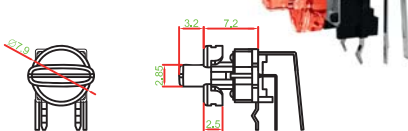
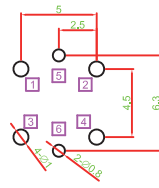
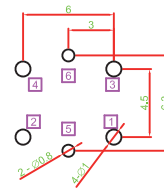
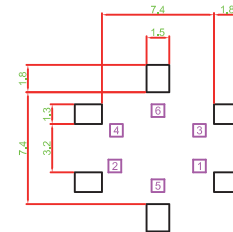
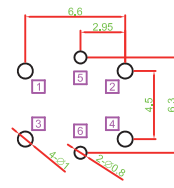
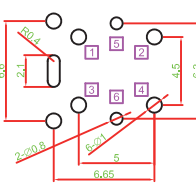
**R10 TYPE**

**▶ P.C.B LAYOUT**
**RIGHT ANGLE**

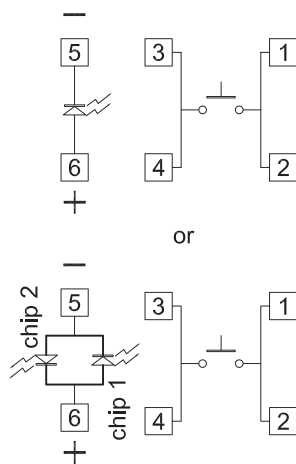
**FRAME : B**

**FRAME : B1**

**FRAME : D**

**FRAME : E**

**▶ MATERIAL**

- COVER : PA
- ACTUATOR : PA + GF
- BASE FRAME : PA + GF
- BRASS TERMINAL : SILVER PLATING
- STEADY PLATE : SUS

**▶ SCHEMATIC**

	0	1	2	3	4	5	6	7	8	9	10	11	12	13	14	15	16	17	18	19	
A	0	1	2	3	4	5	6	7	8	9	10	11	12	13	14	15	16	17	18	19	
B	A	B	C	D	E	F	G	H	I	J	CH5	CH6	DISK	PIP	C-KEY	CUT	TAKE	REC	ENG	PROC	
C	K	L	M	N	O	P	Q	R	S	T	REPLAY	RET1	RET2	KEY ON	AUTO TAKE						
D	U	V	W	X	Y	Z	POWER	ON OFF	ON	OFF		USER A	USER B	USER C	USER D	USER E	USER F	USER S	USER H	USER I	
E	OK		Auto	Enter	Start	STOP	OPEN	CLOSE	Exit	Move	USER J										
F	SET	Reset	Light	Alarm	Menu	Next	Back	Delete	Motor	Save											
G	Up	Down	Right	Left	Test	End	Insert	Lock	Print	+/-											
H	ESC	BC.	HOME	Health	D-LED 2	OC GENIE	VIDEO INPUT	clr CMOS	Green Power	Save OK											
I				F1	F2	F3	F4	F5	F6	F7											
J	F8	F9	F10	F11	F12	F13	F14	IN 1	IN 2	IN 3											
K	IN 4	IN 5	IN 6																		
L	+	-	x	+	=	↑	→	▲	▶	▶▶											
M							↑	→	↑	→											
N	↑	→	▲	◀	▶	◀	▶	◀	▶												
O			↔	◀	▶																
P				x	✓		Config.	TIME LINE	ME1	ME2											
Q	ME3	ME4	BGND 3D DVE1	BGND 3D DVE2	BUS COLOR	ME BUTTON LINK	*	INSERT	WIPE												
R	⏮	ALL		VP		COPY		RECORD MODE	↕												
S		♥	MUTE																		
T																					
U																					
V							CLEAR	CROSS WIND	AMMO TEMP	BARO PRESS	AIR TEMP										
W	BORE-SIGHT	CANT	LEAD	RANGE	MRS	ZERO	TEST	UD	LR												
X	ID	Dstep	MF	GALL	.	BAND	SETUP	MODE	LINK	FUNC.											
Y	SHIFT					DEL															
Z				RUN	2D	3D	CH1	CH2	CH3	CH4											

Компания «Life Electronics» занимается поставками электронных компонентов импортного и отечественного производства от производителей и со складов крупных дистрибьюторов Европы, Америки и Азии.

С конца 2013 года компания активно расширяет линейку поставок компонентов по направлению коаксиальный кабель, кварцевые генераторы и конденсаторы (керамические, пленочные, электролитические), за счёт заключения дистрибьюторских договоров

Мы предлагаем:

- Конкуренспособные цены и скидки постоянным клиентам.
- Специальные условия для постоянных клиентов.
- Подбор аналогов.
- Поставку компонентов в любых объемах, удовлетворяющих вашим потребностям.
- Приемлемые сроки поставки, возможна ускоренная поставка.
- Доставку товара в любую точку России и стран СНГ.
- Комплексную поставку.
- Работу по проектам и поставку образцов.
- Формирование склада под заказчика.
- Сертификаты соответствия на поставляемую продукцию (по желанию клиента).
- Тестирование поставляемой продукции.
- Поставку компонентов, требующих военную и космическую приемку.
- Входной контроль качества.
- Наличие сертификата ISO.

В составе нашей компании организован Конструкторский отдел, призванный помогать разработчикам, и инженерам.

Конструкторский отдел помогает осуществить:

- Регистрацию проекта у производителя компонентов.
- Техническую поддержку проекта.
- Защиту от снятия компонента с производства.
- Оценку стоимости проекта по компонентам.
- Изготовление тестовой платы монтаж и пусконаладочные работы.



Тел: +7 (812) 336 43 04 (многоканальный)

Email: [org@lifeelectronics.ru](mailto:org@lifeelectronics.ru)