

DATA SHEET

TRANSIENT VOLTAGE SUPPRESSORS

AC/DC POWER SUPPLY

1.5KE series

RoHS compliant & Halogen free



Product specification— April 29, 2019 V.0



Transient Voltage Suppressors (TVS) Data Sheet

Features

- Glass passivated junction
- Low zener impedance
- Excellent clamping capability
- 1500W peak pulse power capability at 10/1000 μ s waveform, repetition rate (duty cycle): 0.01%
- Fast response time
- Typical I_R less than 1 μ A above 12V.
- High Temperature soldering guaranteed: 265 $^{\circ}$ C/10 seconds/.375", (9.5mm) lead length, 5lbs (2.3kg) tension
- Plastic package has underwriters laboratory flammability 94V-0
- Meets MSL level 1, per J-STD-020.
- Safety certification: UL: E244458



Mechanical Data

- Case: JEDEC DO-201 Moulded plastic
- Terminal: Axial leads, solderable per MIL-STD-750, Method 2026
- Polarity: Color band denotes cathode except bi-directional models
- Mounting Position: Any
- Weight: 0.97g

Applications

- I/O interface
- AC/DC power supply
- Low frequency signal transmission line (RS232, RS485, etc.)

Maximum Ratings and Characteristics

Ratings at 25 $^{\circ}$ C ambient temperature unless otherwise specified.

Rating	Symbol	Value	Units
Peak pulse power dissipation at 10/1000 μ s waveform (Note1, Fig.1)	P_{PPM}	Minimum 1500	Watts
Peak pulse current of at 10/1000 μ s waveform (Note 1, Fig.3)	I_{PPM}	See Table	Amps
Steady state power dissipation at $T_L=75^{\circ}$ C (Fig.5)	$P_{M(AV)}$	6.5	Watts
Peak forward surge current, 8.3ms single half sine-wave superimposed on rated load, (JEDEC Method) (Note2, Fig.6)	I_{FSM}	200	Amps
Operating junction and Storage Temperature Range.	T_J, T_{STG}	-55 to +175	$^{\circ}$ C
Typical thermal resistance junction to lead	$R_{\theta JL}$	15	$^{\circ}$ C/W
Typical thermal resistance junction to ambient	$R_{\theta JA}$	75	$^{\circ}$ C/W

Notes: 1. Non-repetitive current pulse, per Fig.3 and derated above $T_A=25^{\circ}$ C per Fig.2.

2. 8.3ms single half sine-wave, or equivalent square wave, duty cycle=4 pulses per minutes maximum.

Dimensions (DO-201)

	Symbol	Millimeters		Inches	
		Min.	Max.	Min.	Max.
L	25.40	-	1.000	-	
T	7.20	9.50	0.285	0.375	
d	4.80	5.30	0.190	0.210	
s	0.96	1.07	0.038	0.042	

Part Number Code

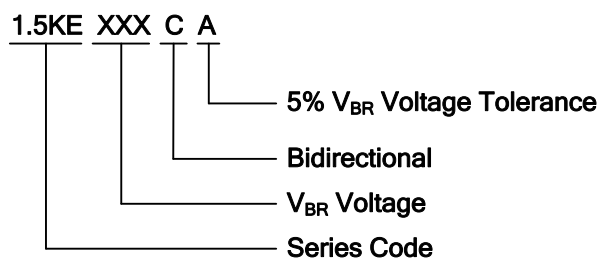

Ordering Code for different package

Box package: Add suffix "/B" at the end of the part number, such as 1.5KE100CA/B

Reel package: Add suffix "/TR13" at the end of the part number, such as 1.5KE75A/TR13

Electrical Characteristics (T_A=25°C)

Part Number		Reverse Stand-Off Voltage	Breakdown Voltage @I _T	Test Current	Maximum Clamping Voltage @I _{PP}	Peak Pulse Current	Reverse Leakage @V _{RWM}
Unidirectional	Bidirectional	V _{RWM} (V)	V _{BR} (V)	I _T (mA)	V _C (V)	I _{PP} (A)	I _R (μA)
1.5KE6.8A	1.5KE6.8CA	5.80	6.45~7.14	10	10.5	144.8	1000
1.5KE7.5A	1.5KE7.5CA	6.40	7.13~7.88	10	11.3	134.5	500
1.5KE8.2A	1.5KE8.2CA	7.02	7.79~8.61	10	12.1	125.6	200
1.5KE9.1A	1.5KE9.1CA	7.78	8.65~9.55	1	13.4	113.4	50
1.5KE10A	1.5KE10CA	8.55	9.50~10.50	1	14.5	104.8	10
1.5KE11A	1.5KE11CA	9.40	10.50~11.60	1	15.6	97.4	5
1.5KE12A	1.5KE12CA	10.20	11.40~12.60	1	16.7	91.0	5
1.5KE13A	1.5KE13CA	11.10	12.40~13.70	1	18.2	83.5	1
1.5KE15A	1.5KE15CA	12.80	14.30~15.80	1	21.2	71.7	1
1.5KE16A	1.5KE16CA	13.60	15.20~16.80	1	22.5	67.6	1
1.5KE18A	1.5KE18CA	15.30	17.10~18.90	1	25.2	60.3	1

Transient Voltage Suppressors 1.5KE**Electrical Characteristics (T_A=25°C)**

Part Number		Reverse Stand-Off Voltage	Breakdown Voltage @I _T	Test Current	Maximum Clamping Voltage @I _{PP}	Peak Pulse Current	Reverse Leakage @V _{RWM}
Unidirectional	Bidirectional	V _{RWM} (V)	V _{BR} (V)	I _T (mA)	V _C (V)	I _{PP} (A)	I _R (μA)
1.5KE20A	1.5KE20CA	17.10	19.00~21.00	1	27.7	54.9	1
1.5KE22A	1.5KE22CA	18.80	20.90~23.10	1	30.6	49.7	1
1.5KE24A	1.5KE24CA	20.50	22.80~25.20	1	33.2	45.8	1
1.5KE27A	1.5KE27CA	23.10	25.70~28.40	1	37.5	40.5	1
1.5KE30A	1.5KE30CA	25.60	28.50~31.50	1	41.4	36.7	1
1.5KE33A	1.5KE33CA	28.20	31.40~34.70	1	45.7	33.3	1
1.5KE36A	1.5KE36CA	30.80	34.20~37.80	1	49.9	30.5	1
1.5KE39A	1.5KE39CA	33.30	37.10~41.00	1	53.9	28.2	1

Electrical Characteristics (T_A=25°C)

Part Number		Reverse Stand-Off Voltage	Breakdown Voltage @I _T	Test Current	Maximum Clamping Voltage @I _{PP}	Peak Pulse Current	Reverse Leakage @V _{RWM}
Unidirectional	Bidirectional	V _{RWM} (V)	V _{BR} (V)	I _T (mA)	V _C (V)	I _{PP} (A)	I _R (μA)
1.5KE43A	1.5KE43CA	36.80	40.90~45.20	1	59.3	25.6	1
1.5KE47A	1.5KE47CA	40.20	44.70~49.40	1	64.8	23.5	1
1.5KE51A	1.5KE51CA	43.60	48.50~53.60	1	70.1	21.7	1
1.5KE56A	1.5KE56CA	47.80	53.20~58.80	1	77.0	19.7	1
1.5KE62A	1.5KE62CA	53.00	58.90~65.10	1	85.0	17.9	1
1.5KE68A	1.5KE68CA	58.10	64.60~71.40	1	92.0	16.5	1
1.5KE75A	1.5KE75CA	64.10	71.30~78.80	1	103.0	14.8	1
1.5KE82A	1.5KE82CA	70.10	77.90~86.10	1	113.0	13.5	1
1.5KE91A	1.5KE91CA	77.80	86.50~95.50	1	125.0	12.2	1
1.5KE100A	1.5KE100CA	85.50	95.00~105.00	1	137.0	11.1	1
1.5KE110A	1.5KE110CA	94.00	105.00~116.00	1	152.0	10.0	1
1.5KE120A	1.5KE120CA	102.00	114.00~126.00	1	165.0	9.2	1
1.5KE130A	1.5KE130CA	111.00	124.00~137.00	1	179.0	8.5	1
1.5KE150A	1.5KE150CA	128.00	143.00~158.00	1	207.0	7.3	1
1.5KE160A	1.5KE160CA	136.00	152.00~168.00	1	219.0	6.9	1
1.5KE170A	1.5KE170CA	145.00	162.00~179.00	1	234.0	6.5	1

Transient Voltage Suppressors 1.5KE

Part Number		Reverse Stand-Off Voltage	Breakdown Voltage @ I_T	Test Current	Maximum Clamping Voltage @ I_{PP}	Peak Pulse Current	Reverse Leakage @ V_{RWM}
Unidirectional	Bidirectional	$V_{RWM}(V)$	$V_{BR}(V)$	$I_T(mA)$	$V_C(V)$	$I_{PP}(A)$	$I_R(\mu A)$
1.5KE180A	1.5KE180CA	154.00	171.00~189.00	1	246.0	6.2	1
1.5KE200A	1.5KE200CA	171.00	190.00~210.00	1	274.0	5.5	1
1.5KE220A	1.5KE220CA	185.00	209.00~231.00	1	328.0	4.6	1
1.5KE250A	1.5KE250CA	214.00	237.00~263.00	1	344.0	4.4	1
1.5KE300A	1.5KE300CA	256.00	285.00~315.00	1	414.0	3.7	1
1.5KE350A	1.5KE350CA	300.00	332.00~368.00	1	482.0	3.2	1
1.5KE400A	1.5KE400CA	342.00	380.00~420.00	1	548.0	2.8	1
1.5KE440A	1.5KE440CA	376.00	418.00~462.00	1	602.0	2.5	1
1.5KE480A	1.5KE480CA	408.00	456.00~504.00	1	658.0	2.3	1
1.5KE510A	1.5KE510CA	434.00	485.00~535.00	1	698.0	2.1	1
1.5KE530A	1.5KE530CA	450.00	503.50~556.50	1	725.0	2.1	1
1.5KE540A	1.5KE540CA	459.00	513.00~567.00	1	740.0	2.0	1
1.5KE550A	1.5KE550CA	467.00	522.50~577.50	1	760.0	2.0	1

Notes: For bidirectional type having V_{RWM} of 10V and less, the I_R limit is double.

Ratings and Characteristic Curves ($T_A=25^\circ\text{C}$ unless otherwise noted)

Figure 1. Peak Pulse Power Rating Curve

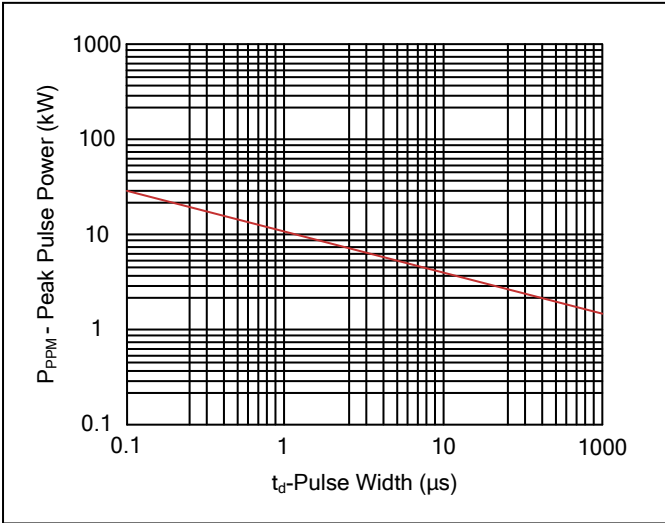

Figure 2. Pulse Derating Curve

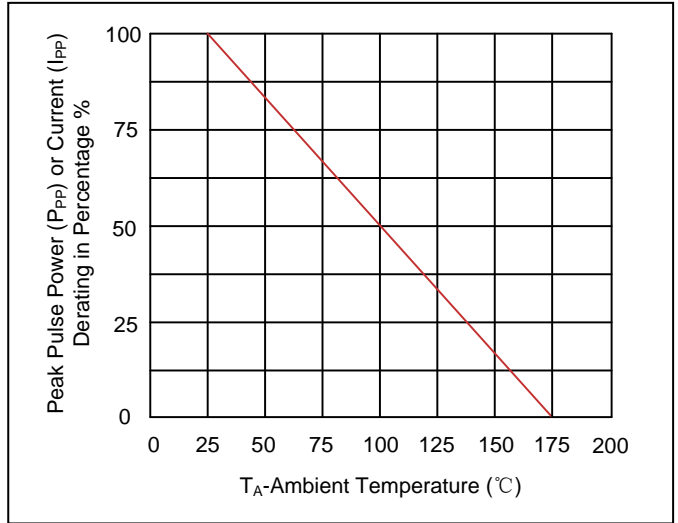

Figure 3. Pulse Waveform

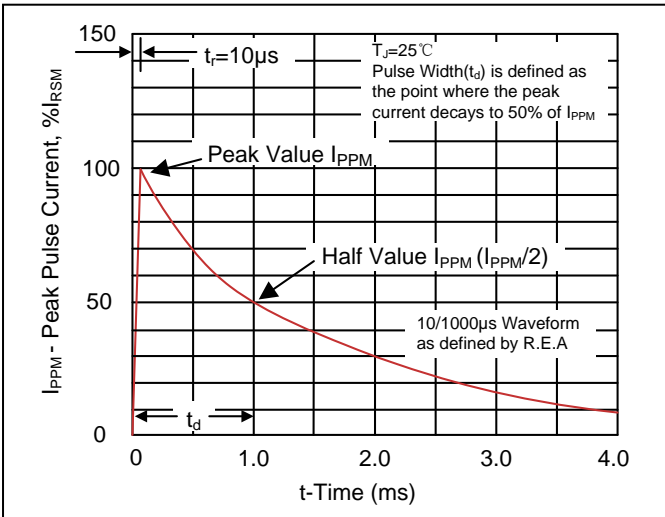

Figure 4. Typical Junction Capacitance

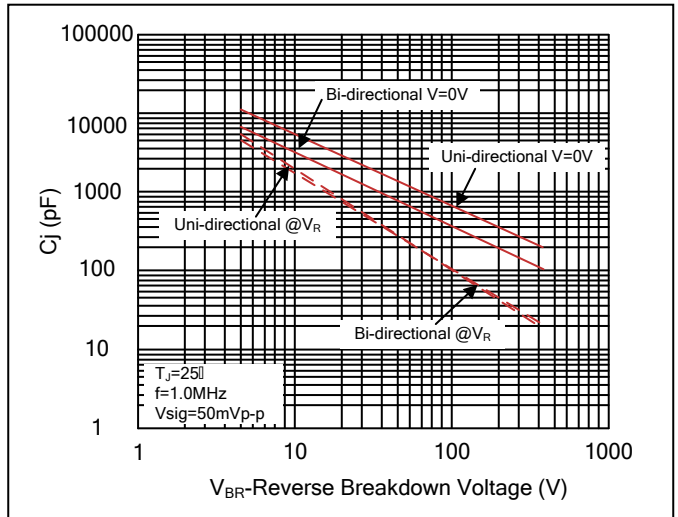

Figure 5. Steady State Power Dissipation Derating Curve

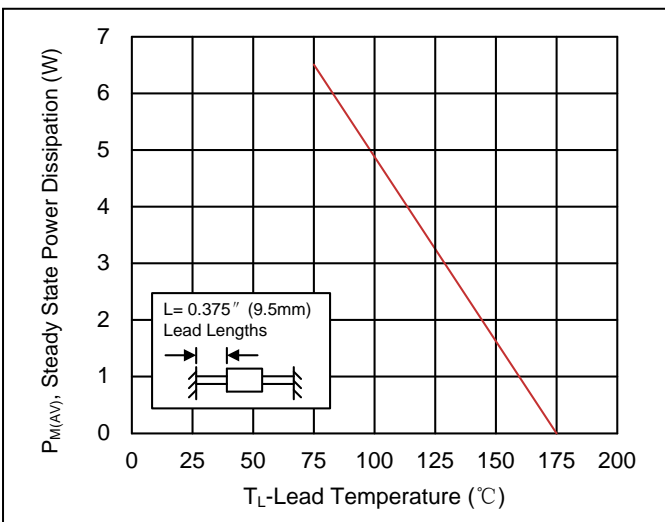
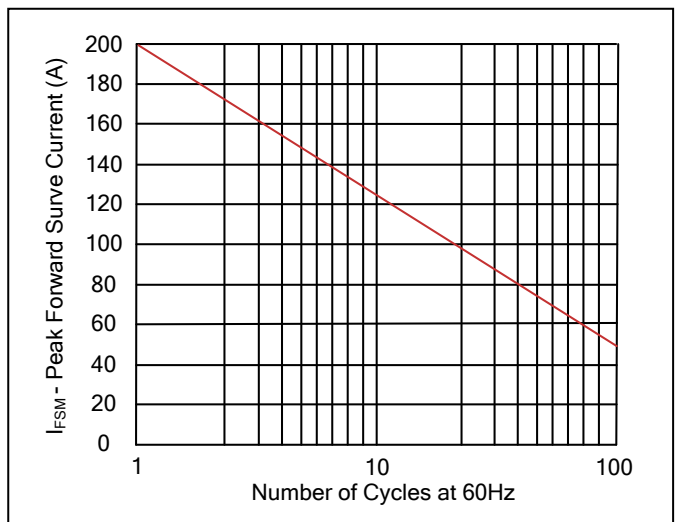

Figure 6. Maximum Non-Repetitive Forward Surge Current Uni-Directional Only



Recommended Soldering Conditions

Wave Soldering



Item	Conditions
Peak Temperature	265°C
Dipping Time	10 seconds
Soldering	1 time

Marking Code



Packaging

Tape	Symbol	Dimension (mm)	
	A	10.0±0.5	
	B	53.0±1.0	
	Z	1.2Max.	
	T	6.0±0.4	
	E	0.8Max.	
	L1-L2	1.0Max.	
	<p>Box</p>	L	250.0±5.0
		W	75.0±5.0
		H	114.0±5.0
	Quantity: 1000PCS		
<p>Reel</p>	D	330.0±3.0	
	D0	16.4±2.0	
	D1	86.0±2.0	
	W1	76.0±3.0	
	Quantity: 1200PCS		

Компания «Life Electronics» занимается поставками электронных компонентов импортного и отечественного производства от производителей и со складов крупных дистрибьюторов Европы, Америки и Азии.

С конца 2013 года компания активно расширяет линейку поставок компонентов по направлению коаксиальный кабель, кварцевые генераторы и конденсаторы (керамические, пленочные, электролитические), за счёт заключения дистрибьюторских договоров

Мы предлагаем:

- Конкурентоспособные цены и скидки постоянным клиентам.
- Специальные условия для постоянных клиентов.
- Подбор аналогов.
- Поставку компонентов в любых объемах, удовлетворяющих вашим потребностям.
- Приемлемые сроки поставки, возможна ускоренная поставка.
- Доставку товара в любую точку России и стран СНГ.
- Комплексную поставку.
- Работу по проектам и поставку образцов.
- Формирование склада под заказчика.
- Сертификаты соответствия на поставляемую продукцию (по желанию клиента).
- Тестирование поставляемой продукции.
- Поставку компонентов, требующих военную и космическую приемку.
- Входной контроль качества.
- Наличие сертификата ISO.

В составе нашей компании организован Конструкторский отдел, призванный помогать разработчикам, и инженерам.

Конструкторский отдел помогает осуществить:

- Регистрацию проекта у производителя компонентов.
- Техническую поддержку проекта.
- Защиту от снятия компонента с производства.
- Оценку стоимости проекта по компонентам.
- Изготовление тестовой платы монтаж и пусконаладочные работы.



Тел: +7 (812) 336 43 04 (многоканальный)

Email: org@lifeelectronics.ru