

PRODUCT NUMBER	DESCRIPTION	NOTES
10117947-XXXXLF	NON-HF	SEE SHT. 3
10117947-XXXXHLF	HALOGEN FREE (H)	SEE SHT. 3



CABLE TIE
COLOR: BLACK
SEE NOTE 14



SECTION C-C
Mini SAS
CABLE ORIENTATION ONLY
END P2 & END P3

dr	Deborah Ingram	2011/05/23	projection	mm	size	A3	scale	1:1	
eng	Tommy Lin	2014/01/06			ecn no	ELX-N-16648-1			
chr	-	-			rel level	Released			
appr	Roger Cheng	2014/01/07	product family	MiniSAS/SATA	rev	D			
		title	MINI SAS HD 8X TO 2 MINI SAS 2.1		dwg no	10117947		cat. no.	-
www.fci.com		Product - Customer Drw		sheet 1 of 5					

PRODUCT NUMBER	DESCRIPTION	NOTES
10117947-XXXXLF	NON-HF	SEE SHT. 3
10117947-XXXXHLF	HALOGEN FREE (H)	SEE SHT. 3



END P1
MINI SAS HD 8X
ISOMETRIC VIEW



END P2 & END P3
MINI SAS
ISOMETRIC VIEW



KEY 3 & KEY SLOT 2, 4 & 6
○◇ UNIVERSAL PORT

END P2 & END P3
MINI SAS



dr	Deborah Ingram	2011/05/23	projection 	mm 	size	A3	scale	4:5
eng	Tommy Lin	2014/01/06			ecn no	ELX-N-16648-1		
chr	-	-			rel level	Released		
appr	Roger Cheng	2014/01/07	product family	C&A				
		title MINI SAS HD 8X TO 2 MINI SAS 2.1 TRAINED UNIVERSAL FINAL ASSEMBLY (6Gb/s)		dwg no 10117947	rev D			
www.fci.com		cat. no.	-	Product - Customer Drw		sheet 2 of 5		



PRODUCT NUMBER	DESCRIPTION	NOTES
10117947-XXXXLF	NON-HF	SEE SHT. 3
10117947-XXXXHLF	HALOGEN FREE (H)	SEE SHT. 3

PRODUCT NUMBER (NON-HALOGEN FREE) SEE NOTE 16	AWG	"DIM L" LENGTH (Meters)	"DIM M" HEIGHT (mm)
10117947-5020LF	24 AWG	2 M	(20.1)
10117947-5030LF	24 AWG	3 M	(20.1)
10117947-5040LF	24 AWG	4 M	(20.1)
10117947-5050LF	24 AWG	5 M	(20.1)
10117947-5060LF	24 AWG	6 M	(20.1)
10117947-5070LF	24 AWG	7 M	(20.1)
10117947-5080LF	24 AWG	8 M	(20.1)
10117947-5090LF	24 AWG	9 M	(20.1)
10117947-5100LF	24 AWG	10 M	(20.1)
10117947-4020LF	26 AWG	2 M	(20.1)
10117947-4030LF	26 AWG	3 M	(20.1)
10117947-4040LF	26 AWG	4 M	(20.1)
10117947-4050LF	26 AWG	5 M	(20.1)
10117947-4060LF	26 AWG	6 M	(20.1)
10117947-4070LF	26 AWG	7 M	(20.1)
10117947-4080LF	26 AWG	8 M	(20.1)
10117947-3010LF	28 AWG	1 M	(17.3)
10117947-3020LF	28 AWG	2 M	(17.3)
10117947-3030LF	28 AWG	3 M	(17.3)
10117947-3040LF	28 AWG	4 M	(17.3)
10117947-3050LF	28 AWG	5 M	(17.3)
10117947-3060LF	28 AWG	6 M	(17.3)
10117947-2005LF	30 AWG	0.5 M	(17.3)
10117947-2010LF	30 AWG	1 M	(17.3)
10117947-2020LF	30 AWG	2 M	(17.3)
10117947-2030LF	30 AWG	3 M	(17.3)
10117947-2040LF	30 AWG	4 M	(17.3)

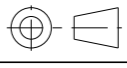
PRODUCT NUMBER (HALOGEN FREE) SEE NOTE 9 AND 16	AWG	"DIM L" LENGTH (Meters)	"DIM M" HEIGHT (mm)
10117947-5020HLF	24 AWG	2 M	(20.1)
10117947-5030HLF	24 AWG	3 M	(20.1)
10117947-5040HLF	24 AWG	4 M	(20.1)
10117947-5050HLF	24 AWG	5 M	(20.1)
10117947-5060HLF	24 AWG	6 M	(20.1)
10117947-5070HLF	24 AWG	7 M	(20.1)
10117947-5080HLF	24 AWG	8 M	(20.1)
10117947-5090HLF	24 AWG	9 M	(20.1)
10117947-5100HLF	24 AWG	10 M	(20.1)
10117947-4020HLF	26 AWG	2 M	(20.1)
10117947-4030HLF	26 AWG	3 M	(20.1)
10117947-4040HLF	26 AWG	4 M	(20.1)
10117947-4045HLF	26 AWG	5 M	(20.1)
10117947-4060HLF	26 AWG	6 M	(20.1)
10117947-4070HLF	26 AWG	7 M	(20.1)
10117947-4080HLF	26 AWG	8 M	(20.1)
10117947-3010HLF	28 AWG	1 M	(17.3)
10117947-3020HLF	28 AWG	2 M	(17.3)
10117947-3030HLF	28 AWG	3 M	(17.3)
10117947-3040HLF	28 AWG	4 M	(17.3)
10117947-3050HLF	28 AWG	5 M	(17.3)
10117947-3060HLF	28 AWG	6 M	(17.3)
10117947-2005HLF	30 AWG	0.5 M	(17.3)
10117947-2010HLF	30 AWG	1 M	(17.3)
10117947-2020HLF	30 AWG	2 M	(17.3)
10117947-2030HLF	30 AWG	3 M	(17.3)
10117947-2040HLF	30 AWG	4 M	(17.3)

dr	Deborah Ingram	2011/05/23			size	A3	scale	1:1
eng	Tommy Lin	2014/01/06			ecn no	ELX-N-16648-1		
chr	-	-			rel level	Released		
appr	Roger Cheng	2014/01/07			product family	C&A		
		title MINI SAS HD 8X TO 2 MINI SAS 2.1 TRAINED UNIVERSAL FINAL ASSEMBLY (6Gb/s)		dwg no 10117947	rev D			
www.fci.com		cat. no.	-	Product - Customer Drw		sheet 3 of 5		

PRODUCT NUMBER	DESCRIPTION	NOTES
10117947-XXXXLF	NON-HF	SEE SHT. 3
10117947-XXXXHLF	HALOGEN FREE (H)	SEE SHT. 3

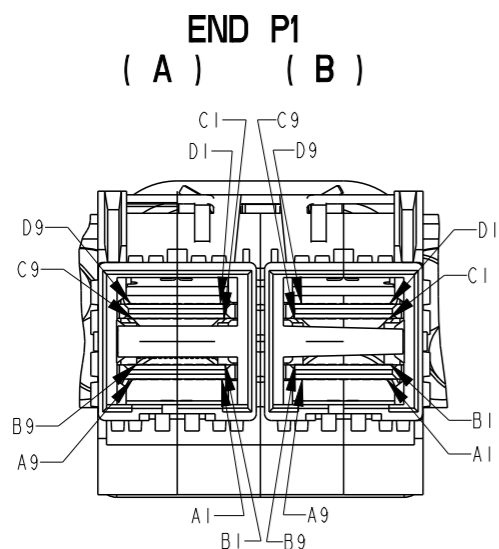

VIEW A
SCALE: 2:1



VIEW B
SCALE: 2:1

LEGEND:

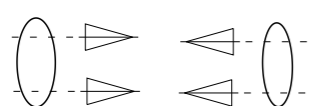

HIGH-SPEED SERIAL
DIFFERENTIAL PAIRS



SIGNAL RETURN



POWER AND MANAGEMENT
INTERFACE

WIRING LIST (SEE NOTE 7)

END P1 (B) MINI SAS HD		CONDUCTOR #	END P2 (MINI SAS)	
SIGNAL	PIN#		PIN#	SIGNAL
GND	A9	PAIR 2	B7	GND
Rx 1-	A5		B6	Tx 1-
Rx 1+	A4		B5	Tx 1+
GND	A3	PAIR 4	B4	GND
Rx 3-	A8		B12	Tx 3-
Rx 3+	A7		B11	Tx 3+
GND	A6		B13	GND
N/C	A1	NO THRU CONNECTION		
Interrupt	A2			
GND	B9	PAIR 1		GND
RX 0-	B5		B3	TX 0-
RX 0+	B4		B2	TX 0+
GND	B3	PAIR 3	B1	GND
RX 2-	B8		B9	TX 2-
RX 2+	B7		B8	TX 2+
GND	B6		B10	GND
N/C	B1	NO THRU CONNECTION		
Mod_PRSL (GND)	B2			
GND	C9		A7	GND
TX 1-	C5	PAIR 2	A6	RX 1-
TX 1+	C4		A5	RX 1+
GND	C3	PAIR 4	A4	GND
TX 3-	C8		A12	RX 3-
TX 3+	C7		A11	RX 3+
GND	C6		A13	GND
SCL	C1	NO THRU CONNECTION		
SDA	C2			
GND	D9			GND
TX 0-	D5	PAIR 1	A3	RX 0-
TX 0+	D4		A2	RX 0+
GND	D3	PAIR 3	A1	GND
TX 2-	D8		A9	RX 2-
TX 2+	D7		A8	RX 2+
GND	D6		A10	GND
N/C	D1	NO THRU CONNECTION		
V+3.3 for EEPROM	D2			
SHELL		BRAID		SHELL

SHIELD-----SHIELD

WIRING LIST (SEE NOTE 7)

END P1 (A) MINI SAS HD		CONDUCTOR #	END P3 (MINI SAS)	
SIGNAL	PIN#		PIN#	SIGNAL
GND	A9	PAIR 2	B7	GND
Rx 1-	A5		B6	Tx 1-
Rx 1+	A4		B5	Tx 1+
GND	A3	PAIR 4	B4	GND
Rx 3-	A8		B12	Tx 3-
Rx 3+	A7		B11	Tx 3+
GND	A6		B13	GND
N/C	A1	NO THRU CONNECTION		
Interrupt	A2			
GND	B9	PAIR 1		GND
RX 0-	B5		B3	TX 0-
RX 0+	B4		B2	TX 0+
GND	B3	PAIR 3	B1	GND
RX 2-	B8		B9	TX 2-
RX 2+	B7		B8	TX 2+
GND	B6		B10	GND
N/C	B1	NO THRU CONNECTION		
Mod_PRSL (GND)	B2			
GND	C9		A7	GND
TX 1-	C5	PAIR 2	A6	RX 1-
TX 1+	C4		A5	RX 1+
GND	C3	PAIR 4	A4	GND
TX 3-	C8		A12	RX 3-
TX 3+	C7		A11	RX 3+
GND	C6		A13	GND
SCL	C1	NO THRU CONNECTION		
SDA	C2			
GND	D9			GND
TX 0-	D5	PAIR 1	A3	RX 0-
TX 0+	D4		A2	RX 0+
GND	D3	PAIR 3	A1	GND
TX 2-	D8		A9	RX 2-
TX 2+	D7		A8	RX 2+
GND	D6		A10	GND
N/C	D1	NO THRU CONNECTION		
V+3.3 for EEPROM	D2			
SHELL		BRAID		SHELL

SHIELD-----SHIELD

dr	Deborah Ingram	2011/05/23	projection	mm	size	A3	scale	1:2
eng	Tommy Lin	2014/01/06			ecn no	ELX-N-16648-1		
chr	-	-			product family	C&A	rel level	Released
appr	Roger Cheng	2014/01/07			dwg no	10117947	rev	D
www.fci.com		cat. no.	-		Product - Customer Drw		sheet 4 of 5	

PRODUCT NUMBER	DESCRIPTION	NOTES
10117947-XXXXLF	NON-HF	SEE SHT. 3
10117947-XXXXHLF	HALOGEN FREE (H)	SEE SHT. 3

NOTES:

- MATERIALS MINI SAS HD (END P1)
BACK SHELLS: ZINC DIE CAST/ COPPER UNDER PLATE/NICKEL OVER PLATE
PULL TAB: THERMOPLASTIC POLYMER
LATCH: STAINLESS STEEL
FERRULE: BRASS
EMI GASKETS: STAINLESS STEEL
LOCTITE
HEAT SHRINK: HIGH POLYMER
PADDLE CARD: PRINTED CIRCUIT SUBSTRATE

- MATERIALS MINI SAS (END P2 & END P3)
BACK SHELLS: ZINC DIE CAST
PULL TAB: THERMOPLASTIC POLYMER
LATCH: STAINLESS STEEL
JET MELT: POLYAMIDE POLYMER
HEAT SHRINK: POLYOLEFIN
PADDLE CARD: PRINTED CIRCUIT SUBSTRATE

- ELECTRICAL PERFORMANCE PER CURRENT REVISION: T10/SAS-2.1

- THIS PRODUCT MEETS THE RESTRICTION OF HAZARDOUS SUBSTANCES IN ELECTRICAL AND ELECTRONIC EQUIPMENT (RoHS) DIRECTIVE (2011/65/EU)

- PRODUCT SPECIFICATIONS: Mini SAS HD GS-12-651, MINI SAS 2.1 GS-12-548

- UNLESS OTHERWISE SPECIFIED ASSEMBLED LENGTH TOLERANCE IS TO BE:
"DIM L" < 1 METERS = ±25mm
"DIM L" 1 METER TO 10 METER = 2% OF "DIM L"

- LABEL DETAILS:

FCI CHINA
FCI P/N
FCI CUSTOMER DRAWING REVISION
FCI SERIAL NUMBER

FONT SHALL BE CLEARLY VISIBLE AND BLACK IN COLOR

- ALL CABLE ASSEMBLIES SHALL BE 100% TESTED FOR CONTINUITY AS DEFINED IN WIRING LIST.
- PACKAGING OF LEAD FREE PRODUCTS MEETS LABELING AND PACKAGING PER SPECIFICATION GS-14-920. PACKAGE CABLE ASSEMBLIES PER GS-14-1272. DUST COVER IS TO BE APPLIED TO MINI SAS HD CONNECTOR PRIOR TO SHIPPING. FCI PACKAGE TRACKING BAG LABEL IS ONLY FOR REFERENCE.

- "H" PRODUCT NUMBERS DESIGNATE THE USE OF HALOGEN FREE RAW CABLE.

- THIS DIMENSION IS A FINISHED PRODUCT LENGTH.

- A "△" SYMBOL WILL BE NEXT TO ANY DIMENSION, VIEW, OR NOTE WHICH HAS BEEN MODIFIED WITH THE CURRENT DRAWING REVISION. THE CURRENT REVISION WILL BE SHOWN IN THE SYMBOL.

- MEETS ELECTRICAL PERFORMANCE REQUIREMENTS OF SAS 2.1.

- MATES WITH SERIES: MINI SAS HS - 100112627 or 10112628
MINI SAS 2.1 - BOARD CONNECTOR 100988870 AND CAGE 10098872

- PLACE A CABLE TIE EVERY 0.5 METERS ON ASSEMBLIES. IN THE CASE OF A 0.5 METER CABLE LENGTH, PLACE THE CABLE TIE MIDWAY BETWEEN CONNECTORS.

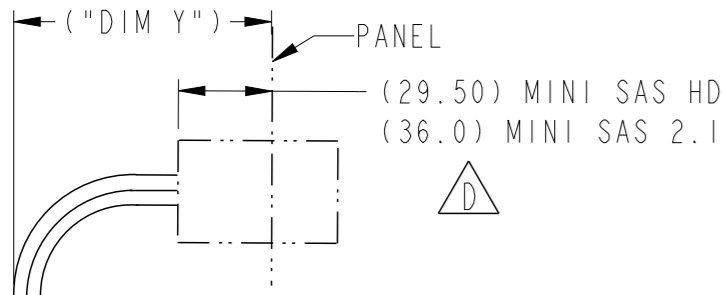

PEND RADIUS
TOP VIEW OF CONNECTOR

MINI SAS HD P1
MINIMUM CABLE BEND TABLE

CABLE	("DIM Y") HF	("DIM Y") NON-HF
24 AWG	101.1	100.6
26 AWG	100.0	99.7
28 AWG	99.1	98.7
30 AWG	98.5	97.9

MINI SAS 2.1 P2 & P3
MINIMUM CABLE BEND TABLE
PER CONNECTOR

CABLE	("DIM Y") HF	("DIM Y") NON-HF
24 AWG	90.6	88.3
26 AWG	85.3	82.9
28 AWG	79.3	76.9
30 AWG	75.7	72.1

△ LABEL EXAMPLE

FCI CHINA
10117947-5020LF
REV.D
CN1323HG205L0001

FCI SERIAL NUMBER IS ONLY FOR TRACKING PRODUCT, DEFINED AS BELOW:

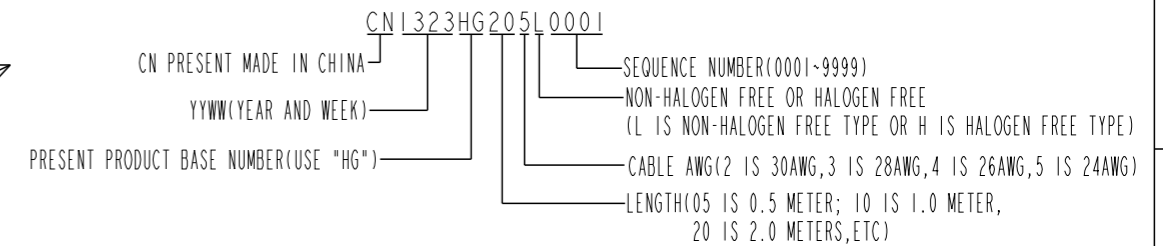

dr	Deborah Ingram	2011/05/23	projection	mm	size	A3	scale	1:1	
eng	Tommy Lin	2014/01/06			ecn no				
chr	-	-			ELX-N-16648-1				
appr	Roger Cheng	2014/01/07	product family	-	rel level				
www.fci.com					MINI SAS HD 8X TO 2 MINI SAS 2.1 TRAINED UNIVERSAL FINAL ASSEMBLY (6Gb/s)		cat. no. -	Product - Customer Drw	sheet 5 of 5



NOTES CONTINUED

15. EEPROM INFORMATION OF MSHD SIDE REFER TO FCI LATEST PRODUCT SPEC. GS-12-651

- CABLE IS OPTIONAL, WHICH HAD BEEN QUALIFIED BY FCI AND MEET FCI PRODUCT SPEC. GS-12-651/548

Компания «Life Electronics» занимается поставками электронных компонентов импортного и отечественного производства от производителей и со складов крупных дистрибьюторов Европы, Америки и Азии.

С конца 2013 года компания активно расширяет линейку поставок компонентов по направлению коаксиальный кабель, кварцевые генераторы и конденсаторы (керамические, пленочные, электролитические), за счёт заключения дистрибьюторских договоров

Мы предлагаем:

- Конкурентоспособные цены и скидки постоянным клиентам.
- Специальные условия для постоянных клиентов.
- Подбор аналогов.
- Поставку компонентов в любых объемах, удовлетворяющих вашим потребностям.
- Приемлемые сроки поставки, возможна ускоренная поставка.
- Доставку товара в любую точку России и стран СНГ.
- Комплексную поставку.
- Работу по проектам и поставку образцов.
- Формирование склада под заказчика.
- Сертификаты соответствия на поставляемую продукцию (по желанию клиента).
- Тестирование поставляемой продукции.
- Поставку компонентов, требующих военную и космическую приемку.
- Входной контроль качества.
- Наличие сертификата ISO.

В составе нашей компании организован Конструкторский отдел, призванный помогать разработчикам, и инженерам.

Конструкторский отдел помогает осуществить:

- Регистрацию проекта у производителя компонентов.
- Техническую поддержку проекта.
- Защиту от снятия компонента с производства.
- Оценку стоимости проекта по компонентам.
- Изготовление тестовой платы монтаж и пусконаладочные работы.



Тел: +7 (812) 336 43 04 (многоканальный)

Email: org@lifeelectronics.ru